

PXD10-xxWSxx Single Output DC/DC Converter

9 to 36 Vdc and 18 to 75 Vdc input, 3.3 to 15 Vdc Single Output, 10W



Applications

- Distributed power architectures
- Computer equipment
- Communications equipment

Features

- Single output current up to 2.5A
- 10 watts maximum output power
- 4:1 ultra wide input voltage range of 9-36 and 18-75VDC
- Six-sided continuous shield
- High efficiency up to 84%
- Low profile: 2.00×1.00×0.40 inch (50.8×25.4×10.2 mm)
- Fixed switching frequency
- RoHS compliant
- No minimum load
- Input to output isolation: 1600Vdc,min
- Operating case temperature range: 100°C max
- Output over-voltage protection
- Over-current protection, auto-recovery
- Output short circuit protection

Options

- Heat sinks available for extended operation
- Remote on/off and logic configurations

General Description

The PXD10-xxWSxx single output series offers 10 watts of output power from a 2 X 1 X 0.4 inch package. It has 4:1 ultra wide input voltage of 9-36VDC, 18-75VDC, features 1600VDC of isolation, short circuit, over voltage protection, and six sided shielding. All models are particularly suited to telecommunications, industrial, mobile telecom and test equipment applications.

Table of Contents

Absolute Maximum Rating	P2	Thermal Considerations	P25
Output Specification	P2	Remote ON/OFF Control	P26
Input Specification	P3	Heat Sink	P27
General Specification	P4	Mechanical Data	P27
Characteristic Curves	P5	Recommended Pad Layout	P28
Test Configurations	P21	Soldering Considerations	P28
EMC Consideration	P22	Packaging Information	P29
Input Source Impedance	P24	Part Number Structure	P29
Output Over Current Protection	P24	Safety and Installation Instruction	P30
Output Over Voltage Protection	P24	MTBF and Reliability	P30
Short Circuit Protection	P24		

Absolute Maximum Rating				
Parameter	Model	Min	Max	Unit
Input Voltage	24WSxx 48WSxx		36	V_{DC}
			75	
Transient (100ms)	24WSxx 48WSxx		50	
			100	
Operating Ambient Temperature (with derating)	All	-40	85	°C
Operating Case Temperature			100	°C
Storage Temperature	All	-55	105	°C

Output Specification					
Parameter	Model	Min	Typ	Max	Unit
Output Voltage Range ($V_{in} = V_{in(nom)}$; Full Load ; $T_A=25^{\circ}C$)	xxWS3P3	3.267	3.3	3.333	V_{DC}
	xxWS05	4.95	5	5.05	
	xxWS12	11.88	12	12.12	
	xxWS15	14.85	15	15.15	
Output Regulation Line ($V_{in(min)}$ to $V_{in(max)}$ at Full Load) Load (0% to 100% of Full Load)	All			± 0.2	%
				± 0.5	
Output Ripple & Noise Peak -to- Peak (20MHz bandwidth)	All			50	mV _{P-P}
Temperature Coefficient	All			± 0.02	%/°C
Output Voltage Overshoot ($V_{in(min)}$ to $V_{in(max)}$; Full Load ; $T_A=25^{\circ}C$)	All		0	5	% V_{OUT}
Dynamic Load Response ($V_{in} = V_{in(nom)}$; $T_A=25^{\circ}C$) Load step change from 75% to 100% or 100 to 75% of Full Load Peak Deviation	All		200		mV
	All		250		μS
Output Current	xxWS3P3	0		2500	mA
	xxWS05	0		2000	
	xxWS12	0		830	
	xxWS15	0		670	
Output Over Voltage Protection (Zener diode clamp)	xxWS3P3		3.9		V_{DC}
	xxWS05		6.2		
	xxWS12		15		
	xxWS15		18		
Output Over Current Protection	All		130	150	% FL.
Output Short Circuit Protection	All	Hiccup, automatic recovery			

Input Specification						
Parameter	Model	Min	Typ	Max	Unit	
Operating Input Voltage	24WSxx	9	24	36	Vdc	
	48WSxx	18	48	75		
Input Current (Maximum value at $V_{in} = V_{in(nom)}$; Full Load)	24WS3P3			465	mA	
	24WS05			548		
	24WS12			519		
	24WS15			544		
	48WS3P3			239		
	48WS05			270		
	48WS12			259		
	48WS15			262		
Input Standby Current (Typical value at $V_{in} = V_{in(nom)}$; No Load)	24WS3P3		13		mA	
	24WS05		11			
	24WS12		16			
	24WS15		26			
	48WS3P3		10			
	48WS05		9			
	48WS12		9			
	48WS15		11			
Input Reflected Ripple Current (5 to 20MHz, 12 μ H source impedance)	All		30		mA _{P-P}	
Start Up Time ($V_{in} = V_{in(nom)}$ and constant resistive load) Power up	All		20		mS	
Remote On/Off Control (Option) (The On/Off pin voltage is referenced to $-V_{IN}$) Positive logic On/Off pin High Voltage (Remote On) On/Off pin Low Voltage (Remote Off) Negative logic On/Off pin High Voltage (Remote On) On/Off pin Low Voltage (Remote Off)	Suffix -P	3.5		12	V _{DC}	
	Suffix -P	0		1.2		
	Suffix -N	0		1.2		
	Suffix -N	3.5		12		
	All		20			mA
	All	-0.5		1		mA

General Specification					
Parameter	Model	Min	Typ	Max	Unit
Efficiency ($V_{in} = V_{in(nom)}$; Full Load ; $T_A=25^\circ\text{C}$)	24WS3P3		78		%
	24WS05		80		
	24WS12		84		
	24WS15		81		
	48WS3P3		76		
	48WS05		81		
	48WS12		84		
	48WS15		84		
Isolation Voltage Input to Output Input to Case, Output to Case	All	1600 1600			V_{DC}
Isolation Resistance	All	1			$G\Omega$
Isolation Capacitance	All			300	μF
Switching Frequency	All		300		kHz
Weight	All		27.0		g
MTBF Bellcore TR-NWT-000332, $T_C=40^\circ\text{C}$ MIL-HDBK-217F	All		1.976×10^6 1.416×10^6		hours

Characteristic Curves

All test conditions are at 25°C. The figures are for PXD10-24WS3P3

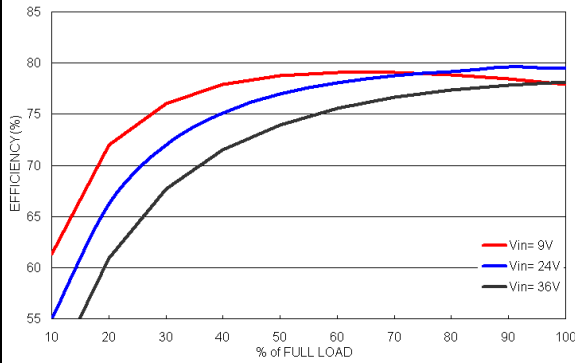

Efficiency versus Output Current

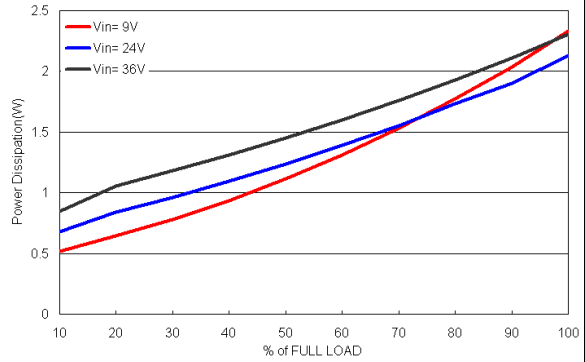

Power Dissipation versus Output Current

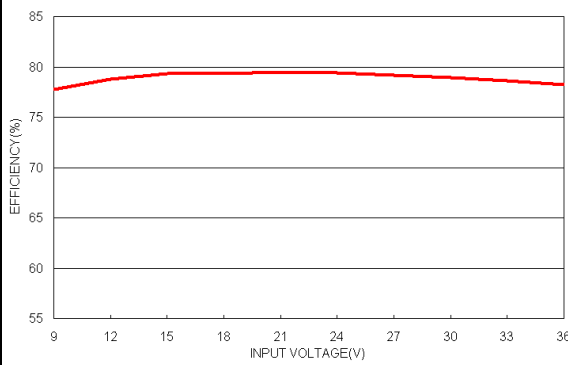

Efficiency versus Input Voltage. Full Load

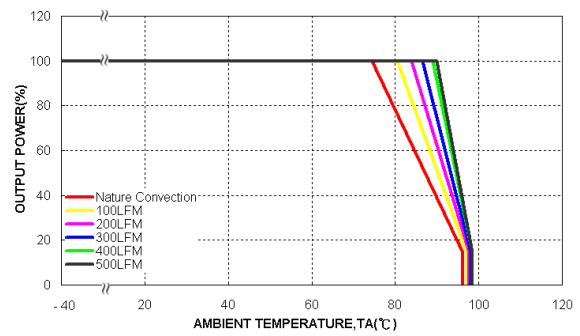

Derating Output Current versus Ambient Temperature and Airflow
Vin = Vin(nom)

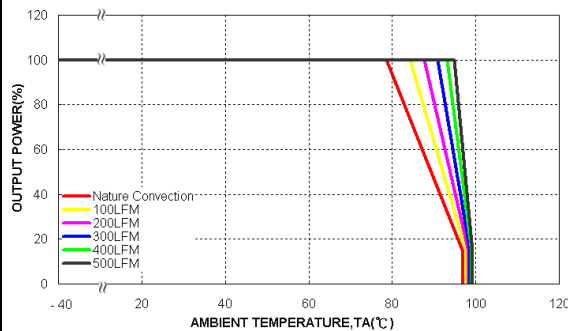

Derating Output Current Versus Ambient Temperature with Heat-Sink
and Airflow, Vin = Vin(nom)

Characteristic Curves (Continued)

All test conditions are at 25°C. The figures are for PXD10-24WS3P3

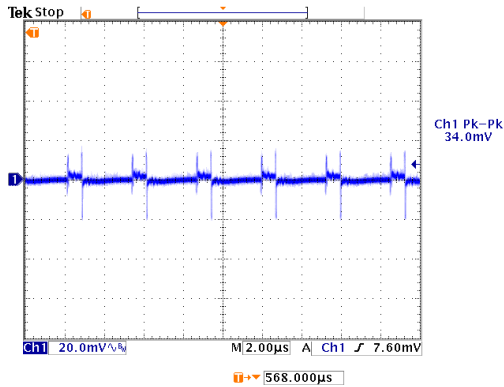

Typical Output Ripple and Noise.
Vin = Vin(nom) ; Full Load

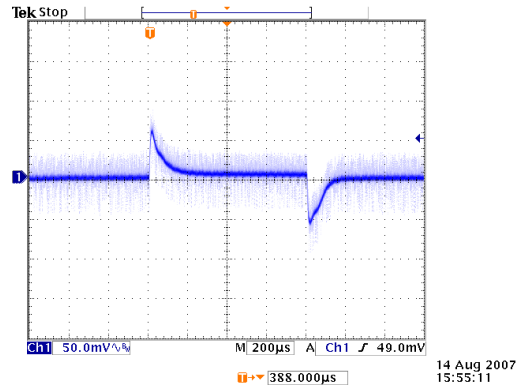

Transient Response to Dynamic Load Change from
100% to 75% to 100% of Full Load ; Vin = Vin(nom)

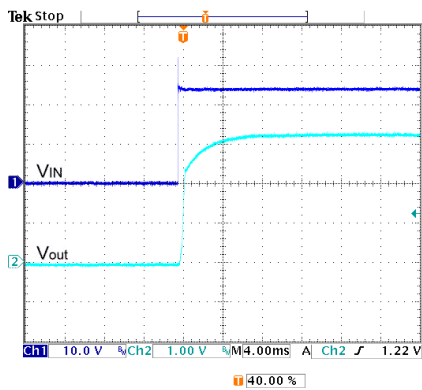

Typical Input Start-up and Output Rise Characteristic
Vin = Vin(nom) ; Full Load

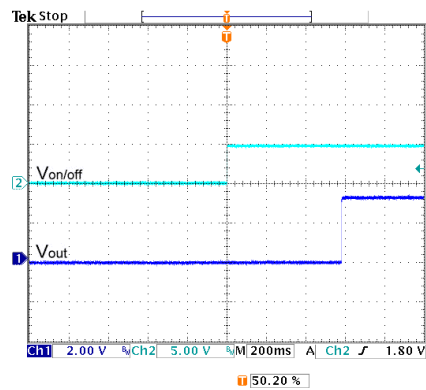

Using ON/OFF Voltage Start-up and Vo Rise Characteristic
Vin = Vin(nom) ; Full Load

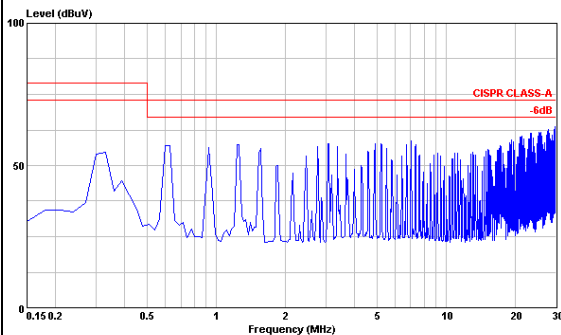

Conduction Emission of EN55022 Class A
Vin = Vin(nom) ; Full Load

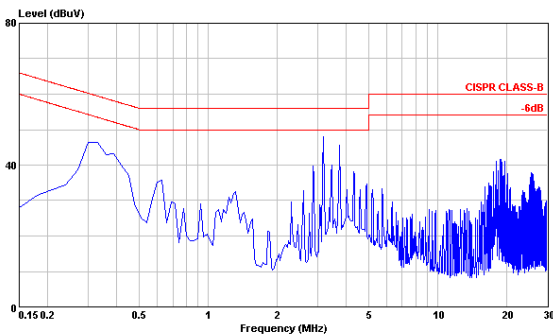

Conduction Emission of EN55022 Class B
Vin = Vin(nom) ; Full Load

Characteristic Curves

All test conditions are at 25°C. The figures are for PXD10-24WS05

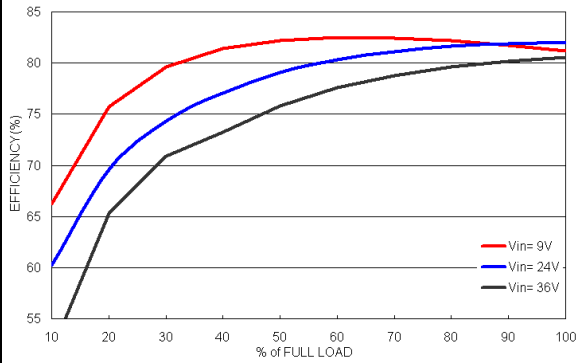

Efficiency versus Output Current

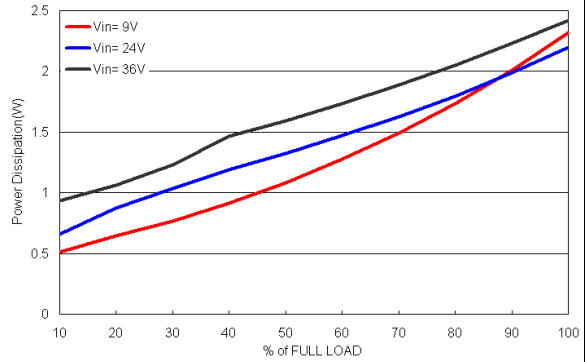

Power Dissipation versus Output Current

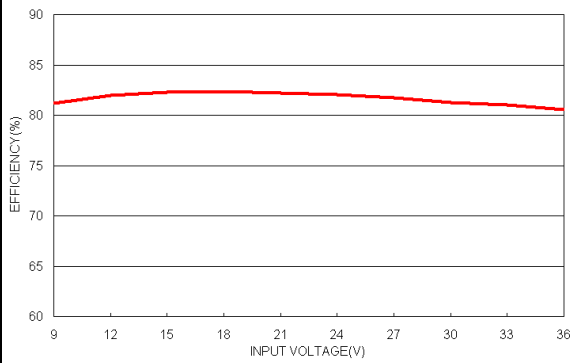

Efficiency versus Input Voltage. Full Load

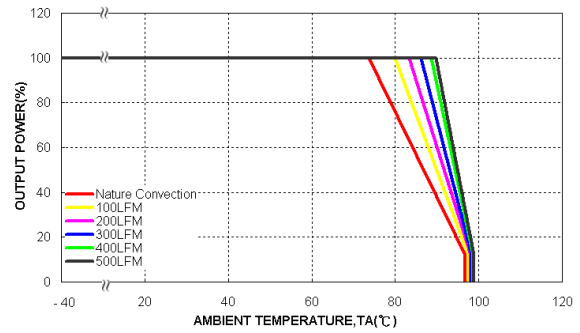

Derating Output Current versus Ambient Temperature and Airflow
Vin = Vin(nom)

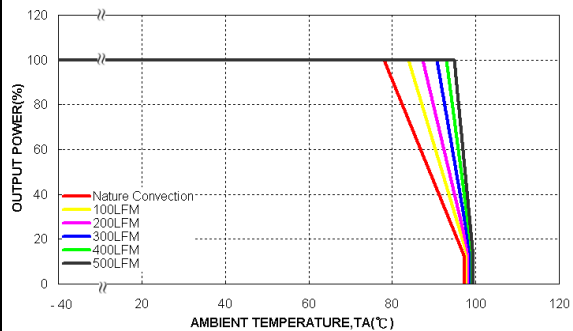

Derating Output Current Versus Ambient Temperature with Heat-Sink
and Airflow, Vin = Vin(nom)

Characteristic Curves (Continued)

All test conditions are at 25°C. The figures are for PXD10-24WS05

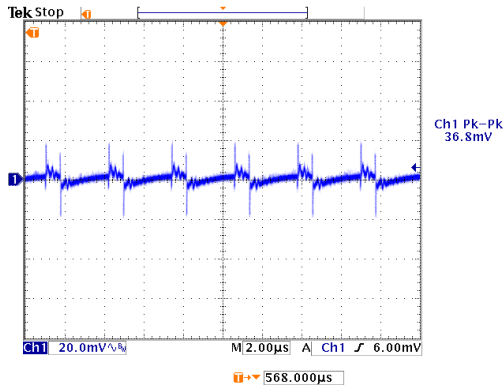

Typical Output Ripple and Noise.
 $V_{in} = V_{in(nom)}$; Full Load

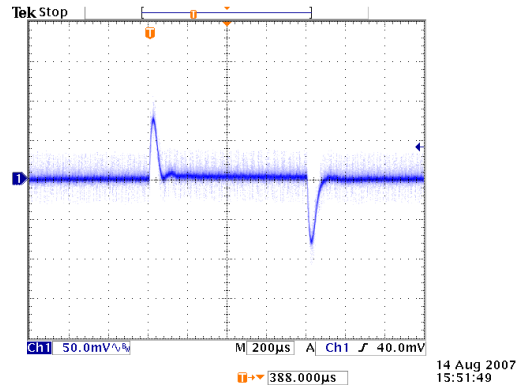

Transient Response to Dynamic Load Change from
 100% to 75% to 100% of Full Load ; $V_{in} = V_{in(nom)}$

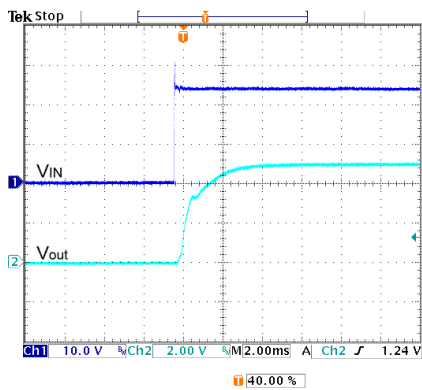

Typical Input Start-up and Output Rise Characteristic
 $V_{in} = V_{in(nom)}$; Full Load

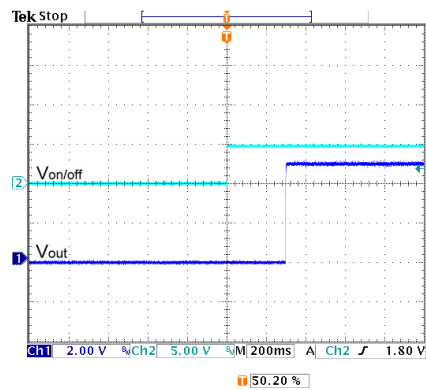

Using ON/OFF Voltage Start-up and V_o Rise Characteristic
 $V_{in} = V_{in(nom)}$; Full Load

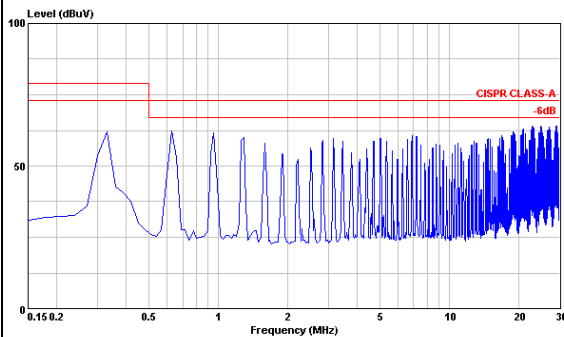

Conduction Emission of EN55022 Class A
 $V_{in} = V_{in(nom)}$; Full Load

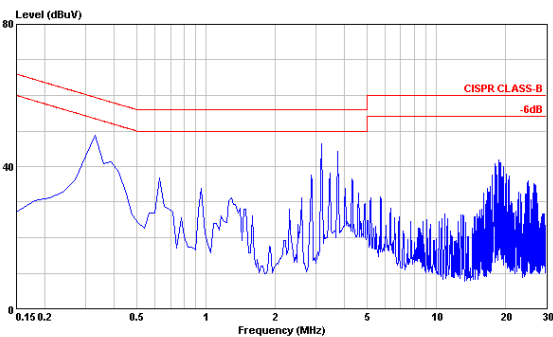

Conduction Emission of EN55022 Class B
 $V_{in} = V_{in(nom)}$; Full Load

Characteristic Curves (Continued)

All test conditions are at 25°C. The figures are for PXD10-24WS12

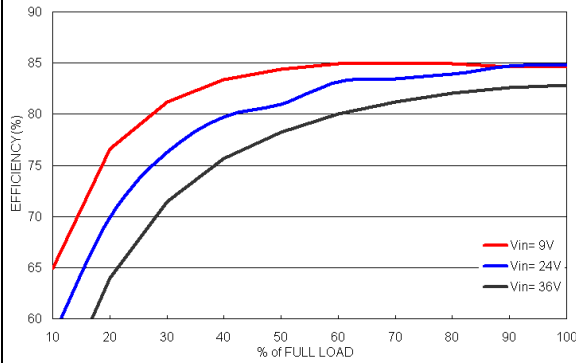

Efficiency versus Output Current

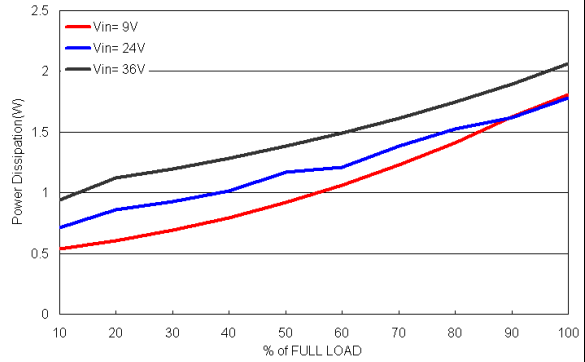

Power Dissipation versus Output Current

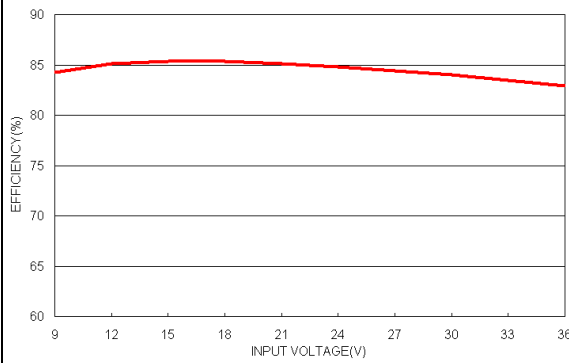

Efficiency versus Input Voltage. Full Load

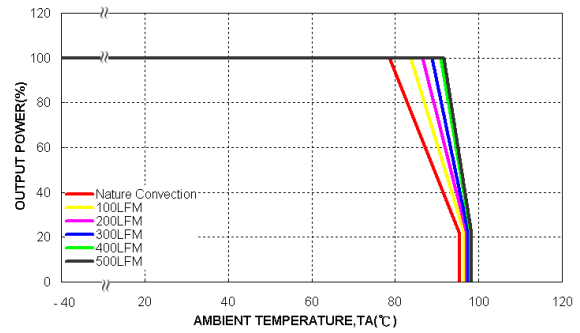

Derating Output Current versus Ambient Temperature and Airflow
Vin = Vin(nom)

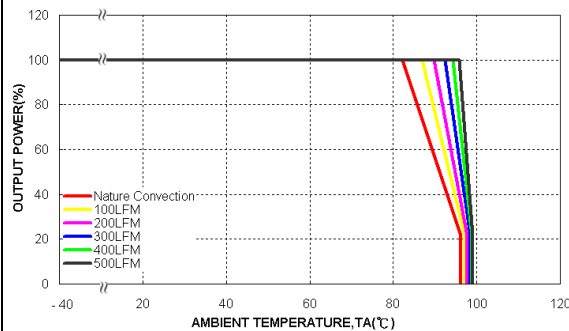

Derating Output Current Versus Ambient Temperature with Heat-Sink
and Airflow, Vin = Vin(nom)

Characteristic Curves (Continued)

All test conditions are at 25°C. The figures are for PXD10-24WS12

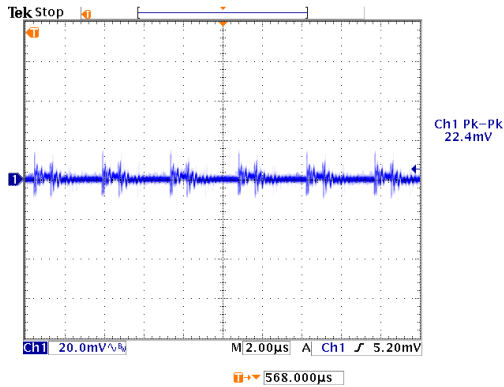

Typical Output Ripple and Noise.
 $V_{in} = V_{in(nom)}$; Full Load

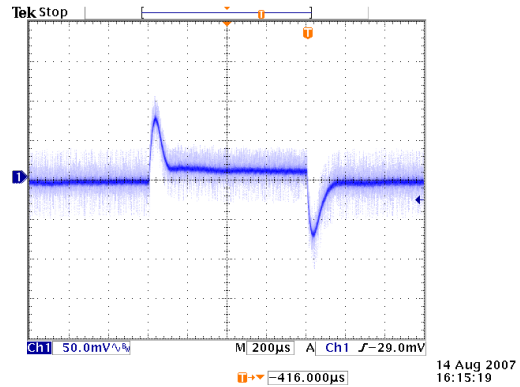

Transient Response to Dynamic Load Change from
 100% to 75% to 100% of Full Load ; $V_{in} = V_{in(nom)}$

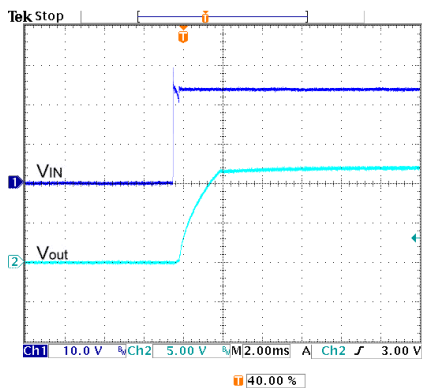

Typical Input Start-up and Output Rise Characteristic
 $V_{in} = V_{in(nom)}$; Full Load

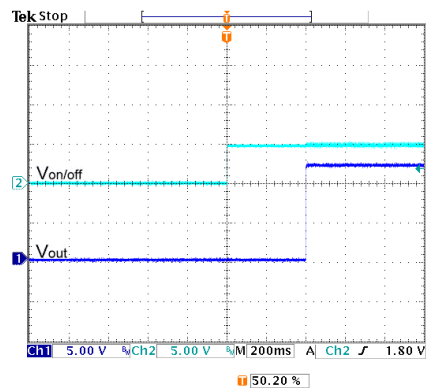

Using ON/OFF Voltage Start-up and V_o Rise Characteristic
 $V_{in} = V_{in(nom)}$; Full Load

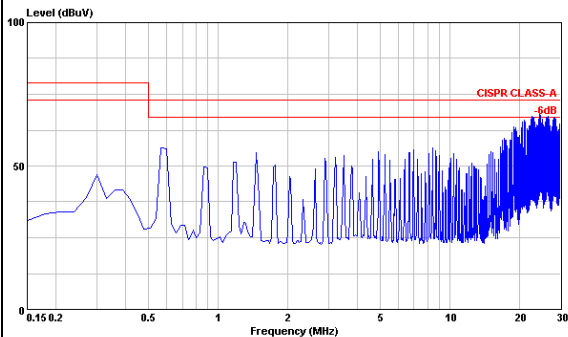

Conduction Emission of EN55022 Class A
 $V_{in} = V_{in(nom)}$; Full Load

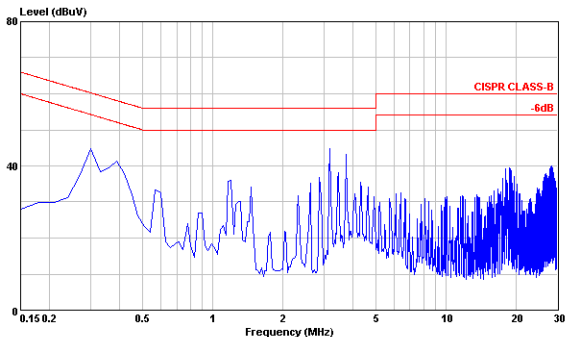

Conduction Emission of EN55022 Class B
 $V_{in} = V_{in(nom)}$; Full Load

Characteristic Curves (Continued)

All test conditions are at 25°C. The figures are for PXD10-24WS15

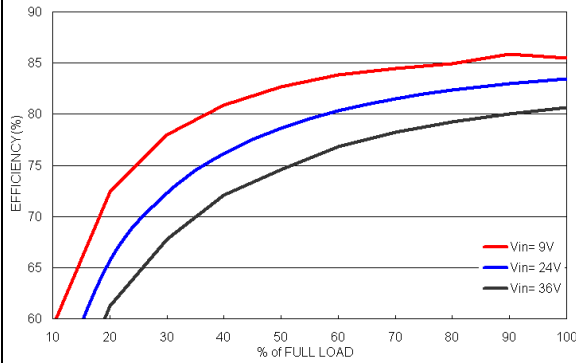

Efficiency versus Output Current

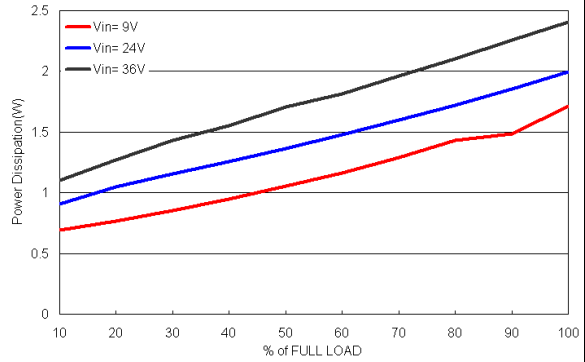

Power Dissipation versus Output Current

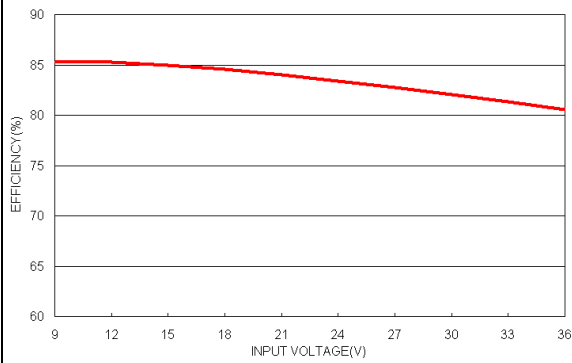

Efficiency versus Input Voltage. Full Load

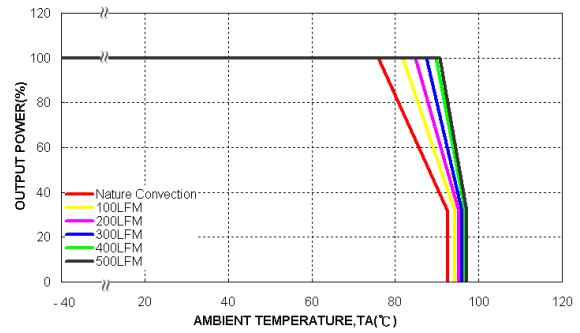

Derating Output Current versus Ambient Temperature and Airflow
Vin = Vin(nom)

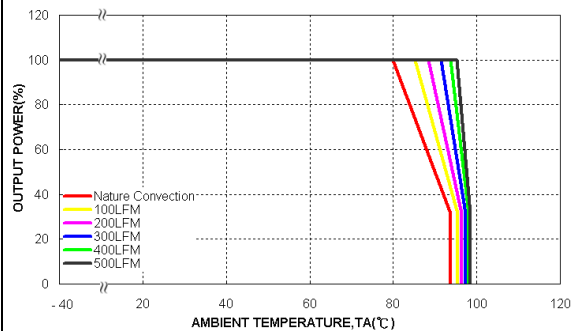

Derating Output Current Versus Ambient Temperature with Heat-Sink and Airflow, Vin = Vin(nom)

Characteristic Curves (Continued)

All test conditions are at 25°C. The figures are for PXD10-24WS15

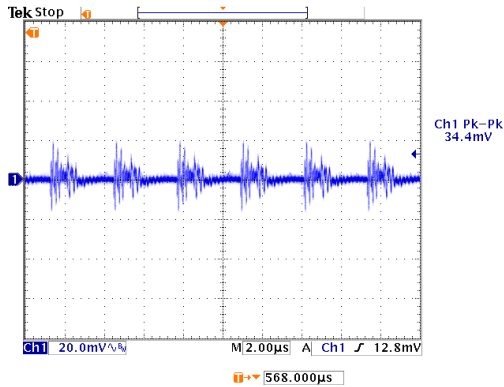

Typical Output Ripple and Noise.
 $V_{in} = V_{in}(nom)$; Full Load

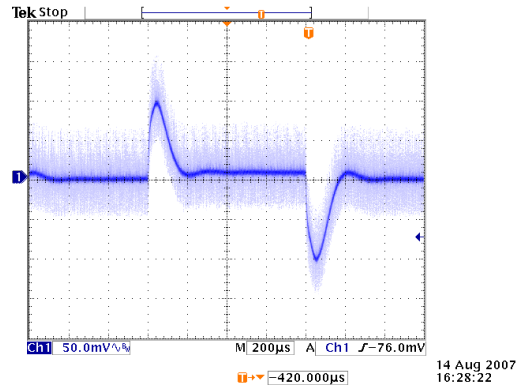

Transient Response to Dynamic Load Change from
 100% to 75% to 100% of Full Load ; $V_{in} = V_{in}(nom)$

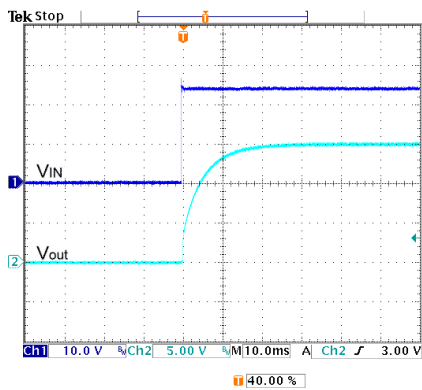

Typical Input Start-up and Output Rise Characteristic
 $V_{in} = V_{in}(nom)$; Full Load

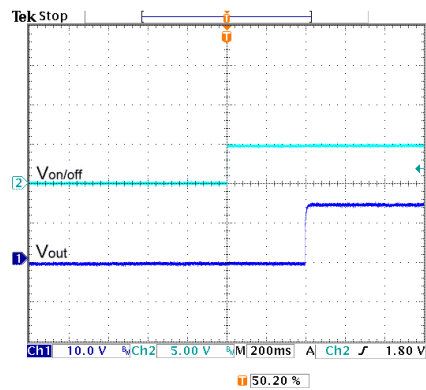

Using ON/OFF Voltage Start-up and V_o Rise Characteristic
 $V_{in} = V_{in}(nom)$; Full Load

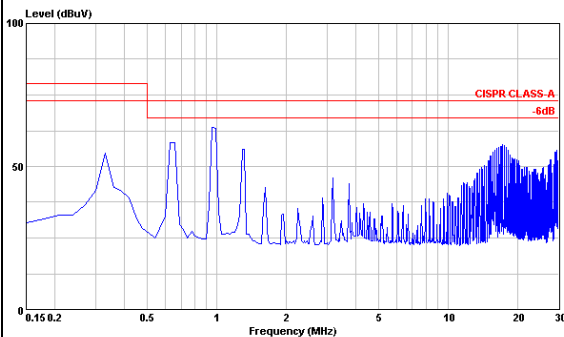

Conduction Emission of EN55022 Class A
 $V_{in} = V_{in}(nom)$; Full Load

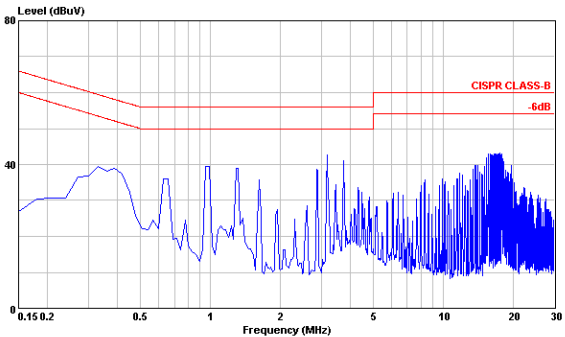

Conduction Emission of EN55022 Class B
 $V_{in} = V_{in}(nom)$; Full Load

Characteristic Curves (Continued)

All test conditions are at 25°C. The figures are for PXD10-48WS3P3

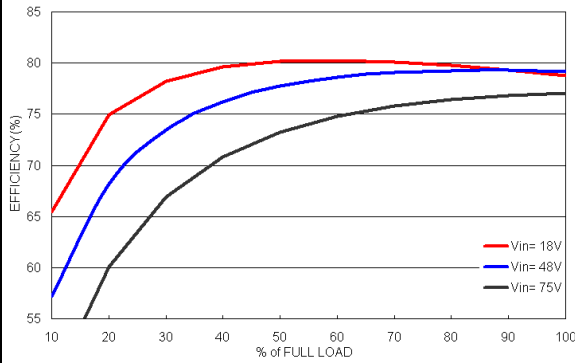

Efficiency versus Output Current

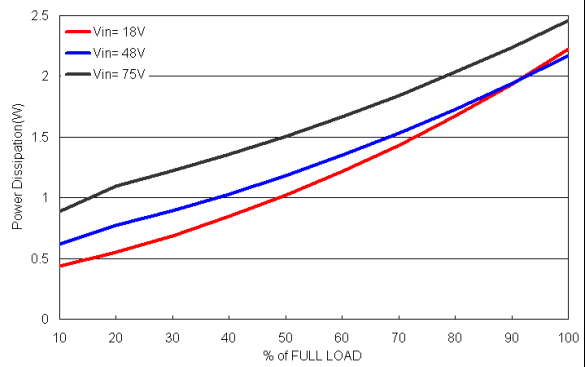

Power Dissipation versus Output Current

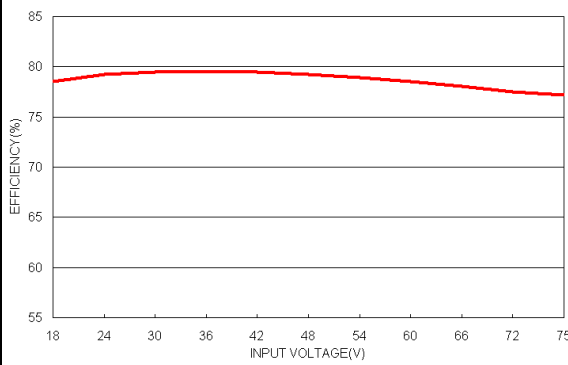

Efficiency versus Input Voltage. Full Load

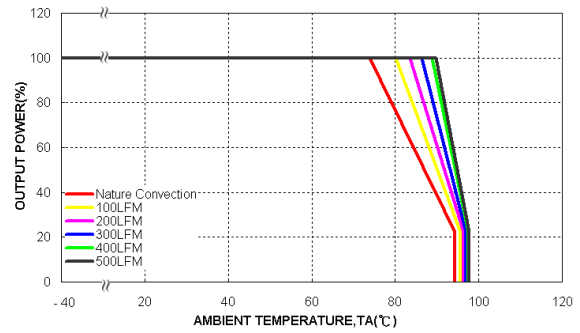

Derating Output Current versus Ambient Temperature and Airflow
Vin = Vin(nom)

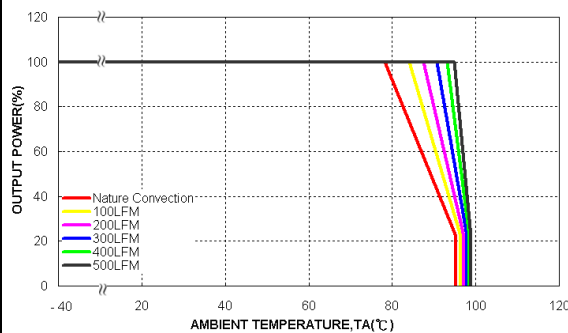

Derating Output Current Versus Ambient Temperature with Heat-Sink
and Airflow, Vin = Vin(nom)

Characteristic Curves (Continued)

All test conditions are at 25°C. The figures are for PXD10-48WS3P3

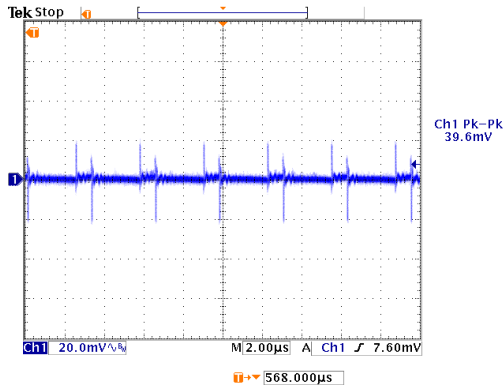

Typical Output Ripple and Noise.
 $V_{in} = V_{in(nom)}$; Full Load

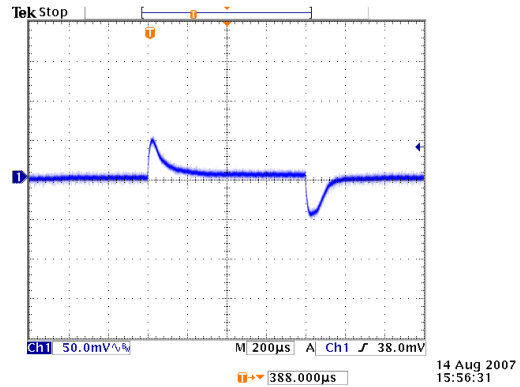

Transient Response to Dynamic Load Change from
 100% to 75% to 100% of Full Load ; $V_{in} = V_{in(nom)}$

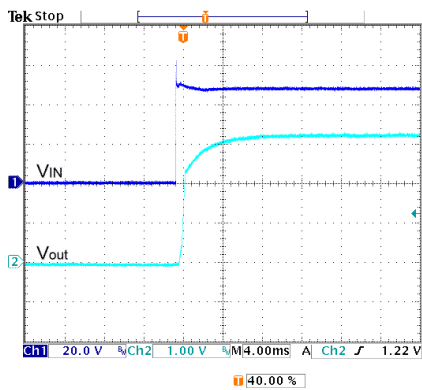

Typical Input Start-up and Output Rise Characteristic
 $V_{in} = V_{in(nom)}$; Full Load

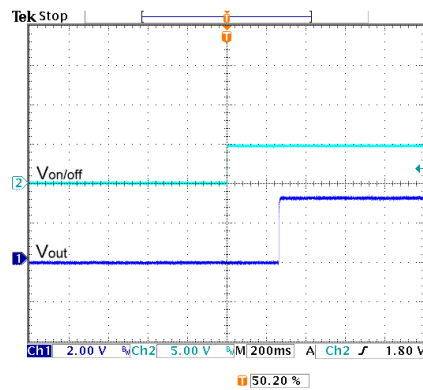

Using ON/OFF Voltage Start-up and V_o Rise Characteristic
 $V_{in} = V_{in(nom)}$; Full Load

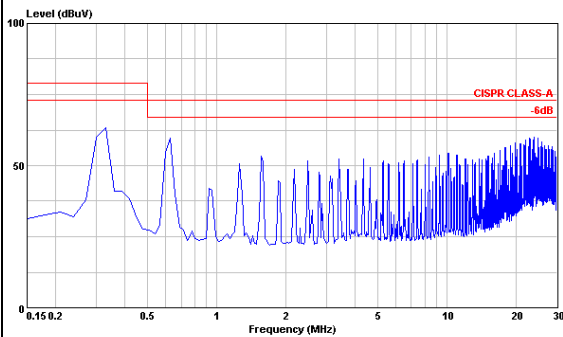

Conduction Emission of EN55022 Class A
 $V_{in} = V_{in(nom)}$; Full Load

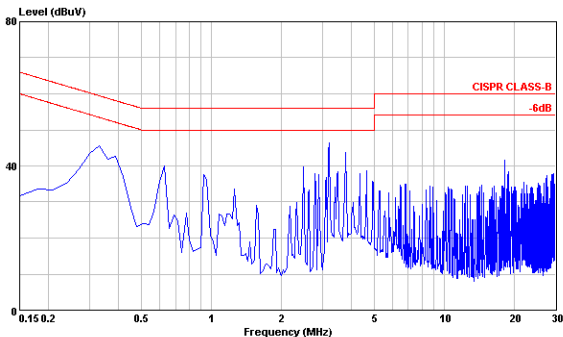

Conduction Emission of EN55022 Class B
 $V_{in} = V_{in(nom)}$; Full Load

Characteristic Curves (Continued)

All test conditions are at 25°C. The figures are for PXD10-48WS05

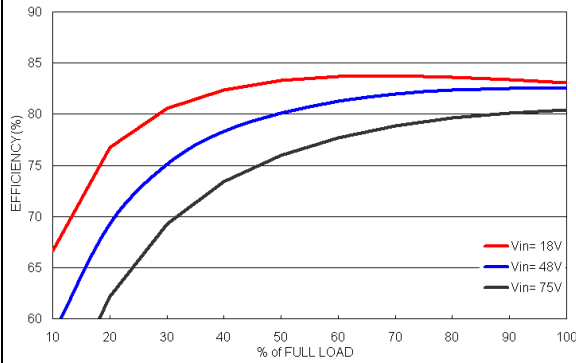

Efficiency versus Output Current

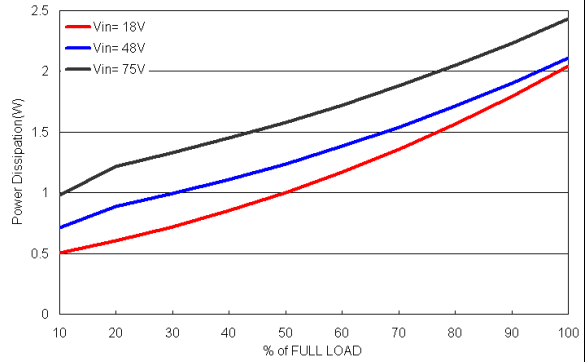

Power Dissipation versus Output Current

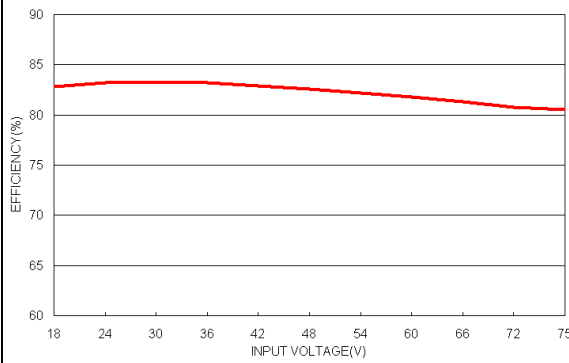

Efficiency versus Input Voltage. Full Load

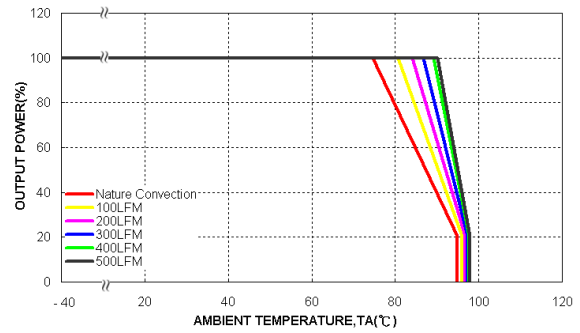

Derating Output Current versus Ambient Temperature and Airflow
Vin = Vin(nom)

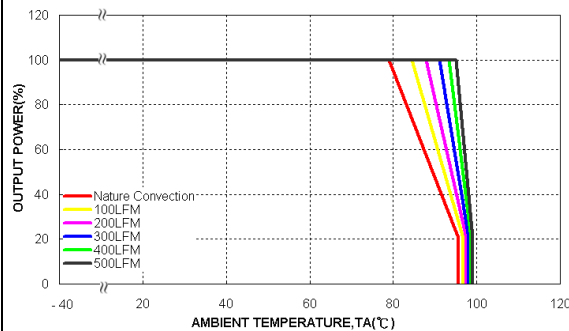

Derating Output Current Versus Ambient Temperature with Heat-Sink and Airflow, Vin = Vin(nom)

Characteristic Curves (Continued)

All test conditions are at 25°C. The figures are for PXD10-48WS05

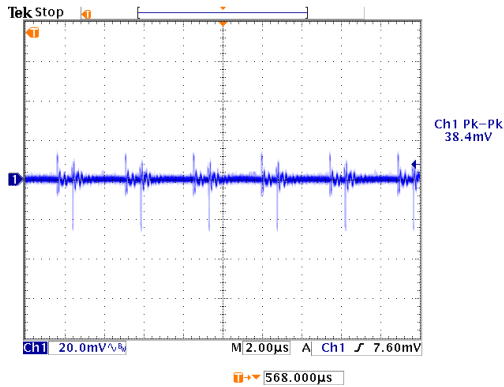

Typical Output Ripple and Noise.
 $V_{in} = V_{in(nom)}$; Full Load

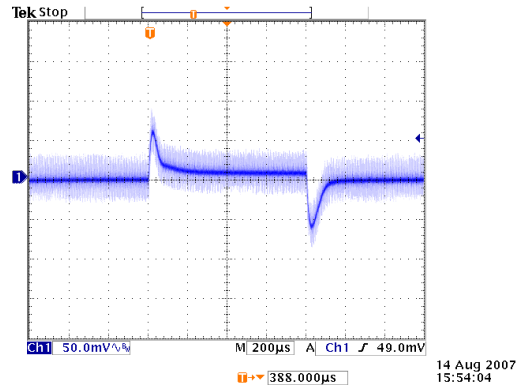

Transient Response to Dynamic Load Change from
 100% to 75% to 100% of Full Load ; $V_{in} = V_{in(nom)}$

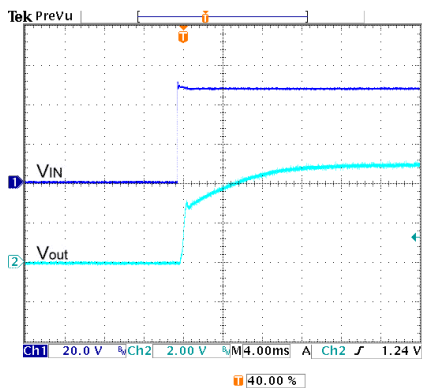

Typical Input Start-up and Output Rise Characteristic
 $V_{in} = V_{in(nom)}$; Full Load

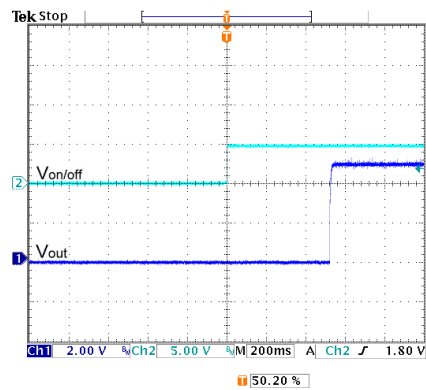

Using ON/OFF Voltage Start-up and V_o Rise Characteristic
 $V_{in} = V_{in(nom)}$; Full Load

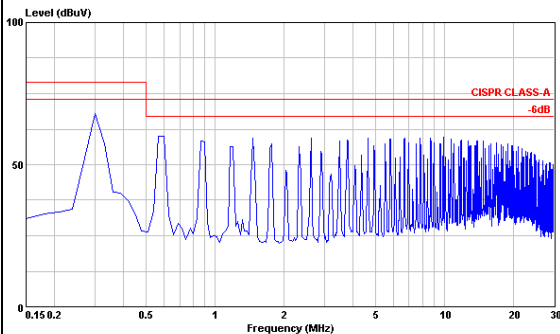

Conduction Emission of EN55022 Class A
 $V_{in} = V_{in(nom)}$; Full Load

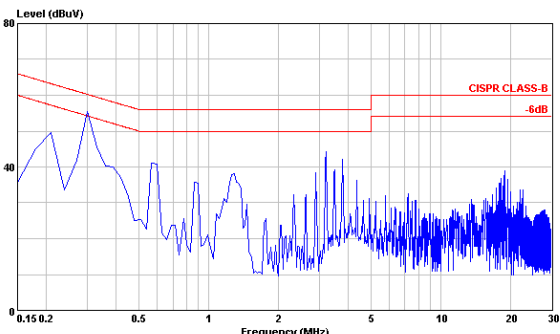

Conduction Emission of EN55022 Class B
 $V_{in} = V_{in(nom)}$; Full Load

Characteristic Curves (Continued)

All test conditions are at 25°C. The figures are for PXD10-48WS12

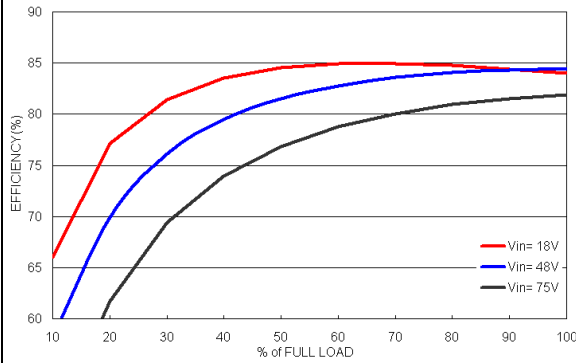

Efficiency versus Output Current

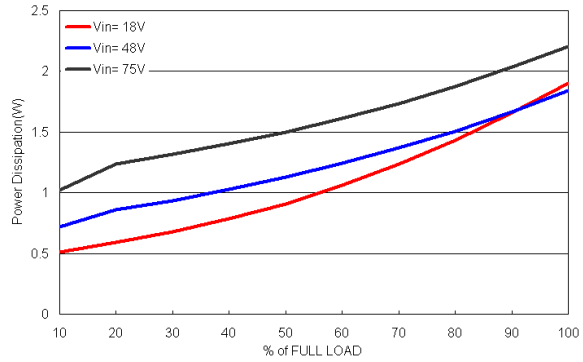

Power Dissipation versus Output Current

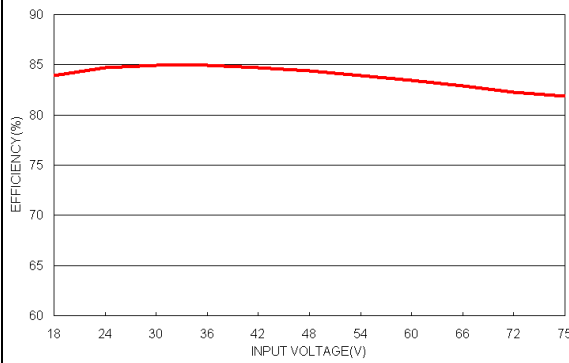

Efficiency versus Input Voltage. Full Load

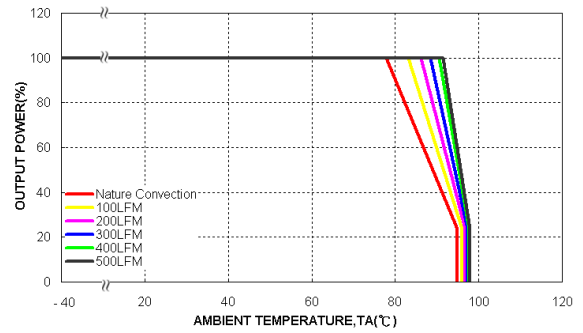

Derating Output Current versus Ambient Temperature and Airflow
Vin = Vin(nom)

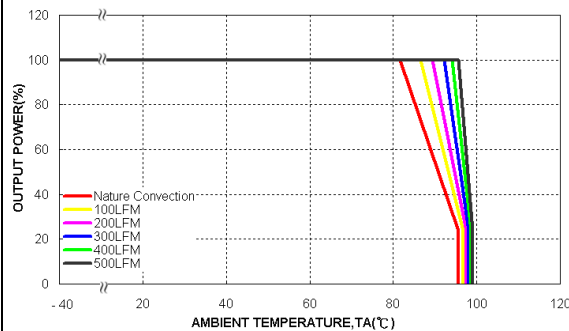

Derating Output Current Versus Ambient Temperature with Heat-Sink
and Airflow, Vin = Vin(nom)

Characteristic Curves (Continued)

All test conditions are at 25°C. The figures are for PXD10-48WS12

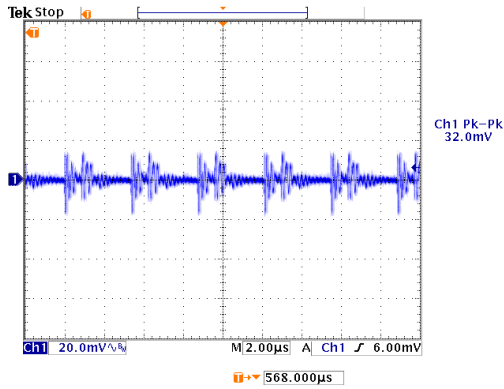

Typical Output Ripple and Noise.
Vin = Vin(nom) ; Full Load

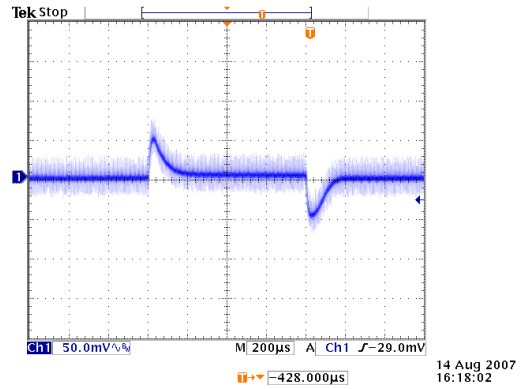

Transient Response to Dynamic Load Change from
100% to 75% to 100% of Full Load ; Vin = Vin(nom)

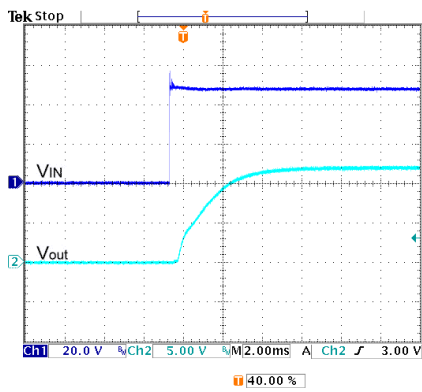

Typical Input Start-Up and Output Rise Characteristic
Vin = Vin(nom) ; Full Load

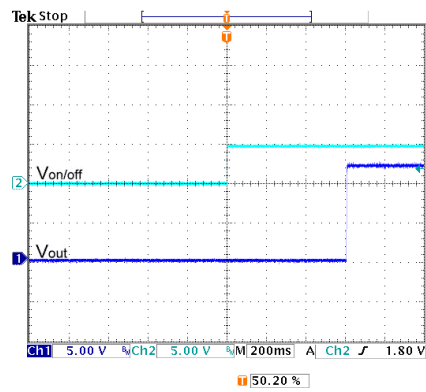

Using ON/OFF Voltage Start-Up and Vo Rise Characteristic
Vin = Vin(nom) ; Full Load

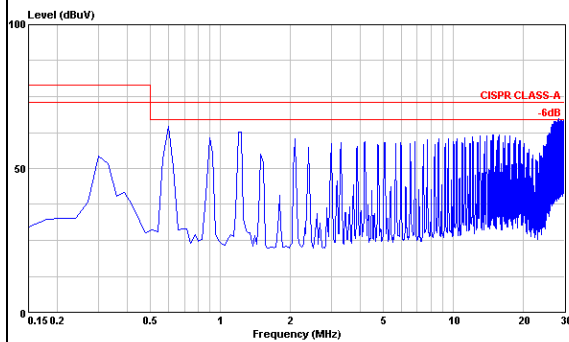

Conduction Emission of EN55022 Class A
Vin = Vin(nom) ; Full Load

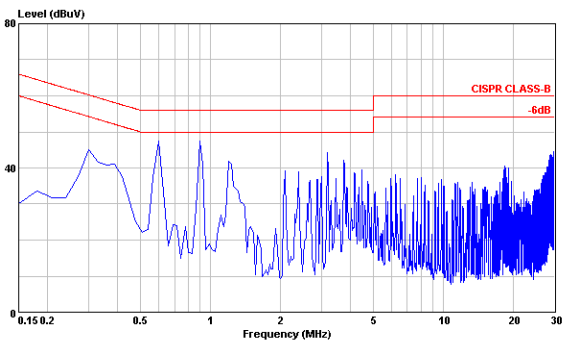

Conduction Emission of EN55022 Class B
Vin = Vin(nom) ; Full Load

Characteristic Curves (Continued)

All test conditions are at 25°C. The figures are for PXD10-48WS15

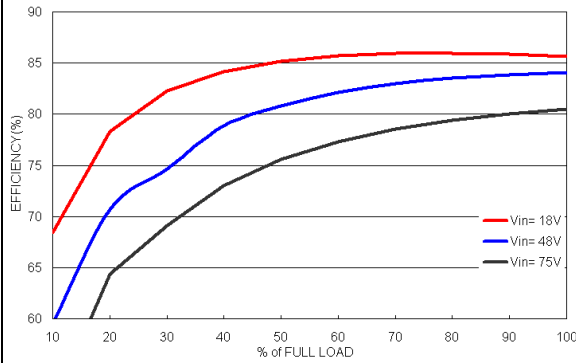

Efficiency versus Output Current

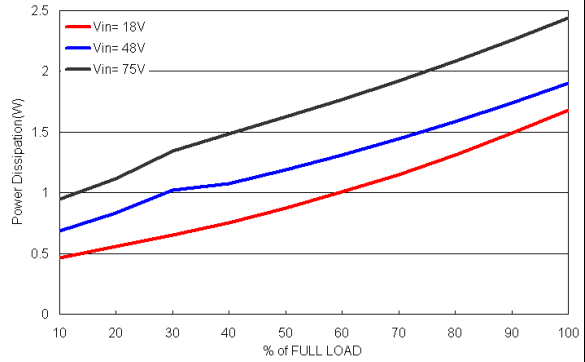

Power Dissipation versus Output Current

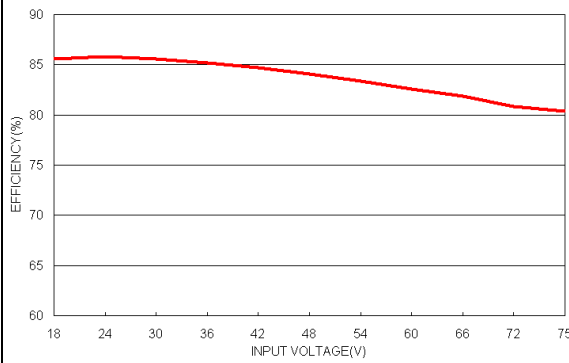

Efficiency versus Input Voltage. Full Load

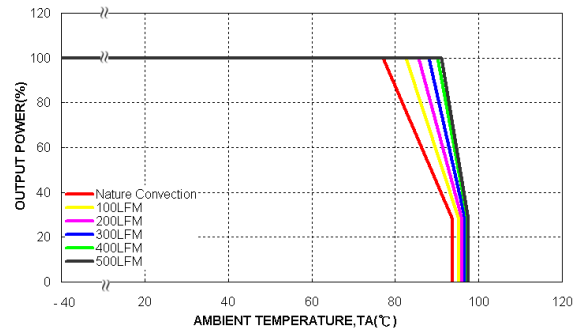

Derating Output Current versus Ambient Temperature and Airflow
Vin = Vin(nom)

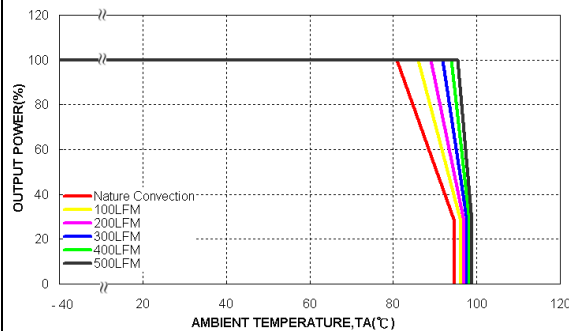

Derating Output Current Versus Ambient Temperature with Heat-Sink
and Airflow, Vin = Vin(nom)

Characteristic Curves (Continued)

All test conditions are at 25°C. The figures are for PXD10-48WS15

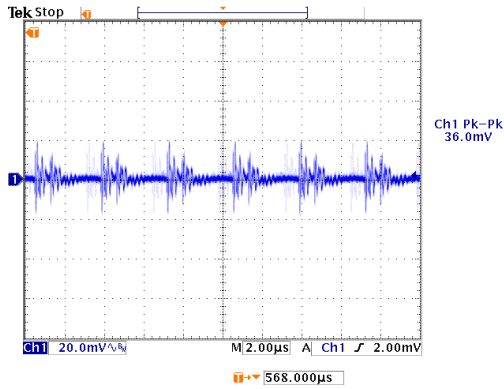

Typical Output Ripple and Noise.
Vin = Vin(nom) ; Full Load

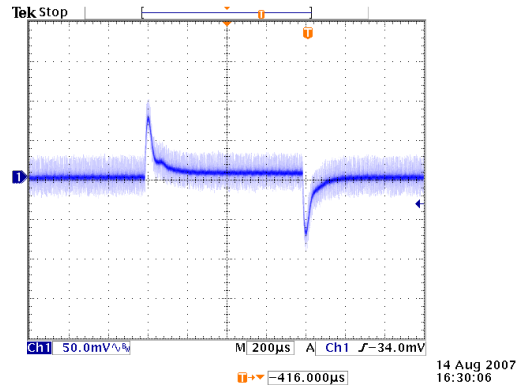

Transient Response to Dynamic Load Change from
100% to 75% to 100% of Full Load ; Vin = Vin(nom)

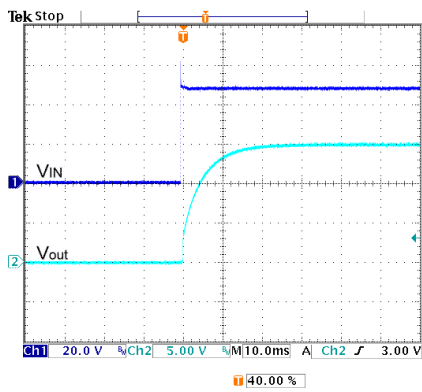

Typical Input Start-Up and Output Rise Characteristic
Vin = Vin(nom) ; Full Load

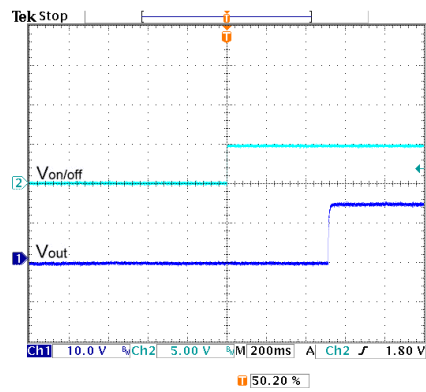

Using ON/OFF Voltage Start-Up and Vo Rise Characteristic
Vin = Vin(nom) ; Full Load

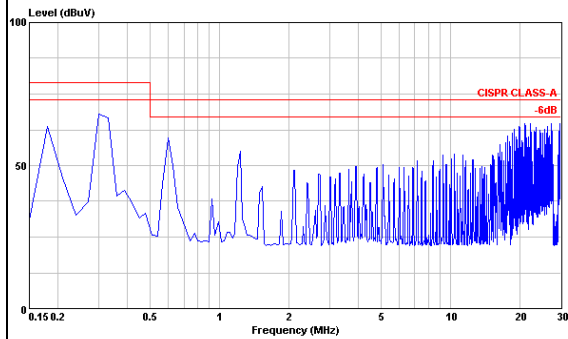

Conduction Emission of EN55022 Class A
Vin = Vin(nom) ; Full Load

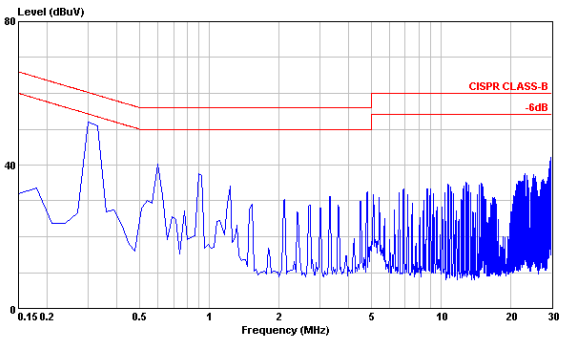

Conduction Emission of EN55022 Class B
Vin = Vin(nom) ; Full Load

Testing Configurations

Input reflected-ripple current measurement test:

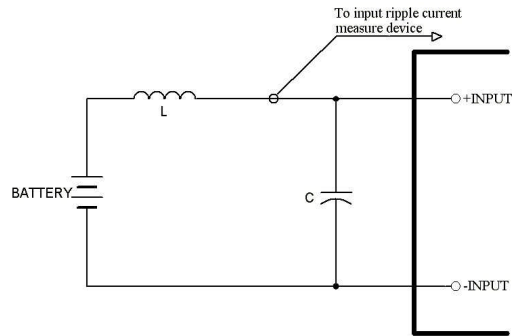

Component	Value	Voltage	Reference
L	12μH	----	----
C	100μF	100V	Aluminum Electrolytic Capacitor

Peak-to-peak output ripple & noise measurement test

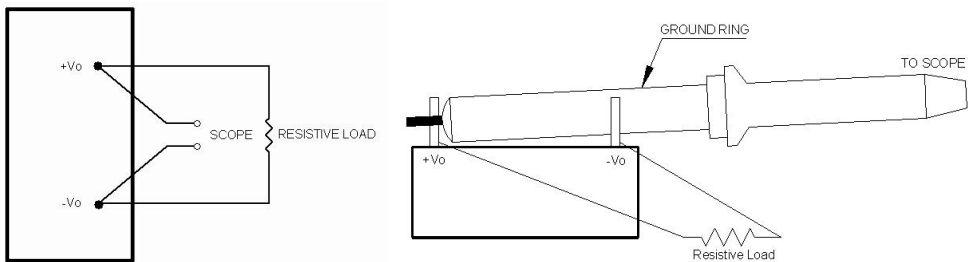

Output voltage and efficiency measurement test

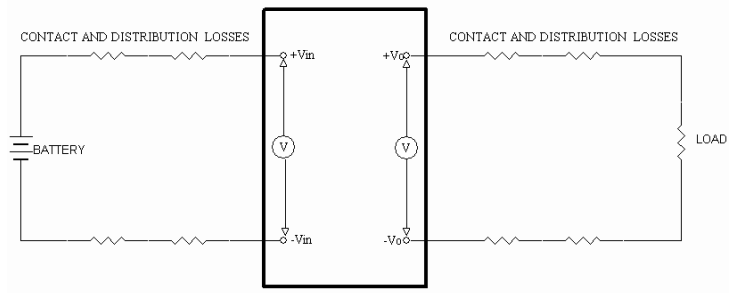

Note: All measurements are taken at the module terminals.

$$Efficiency = \left(\frac{V_o \times I_o}{V_{in} \times I_{in}} \right) \times 100\%$$

EMC considerations

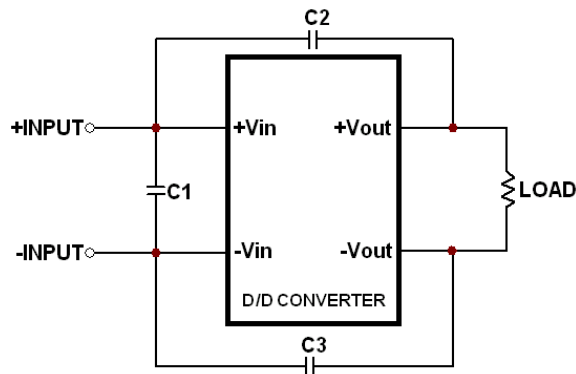

Suggested schematic for EN55022 conducted emission Class A limits

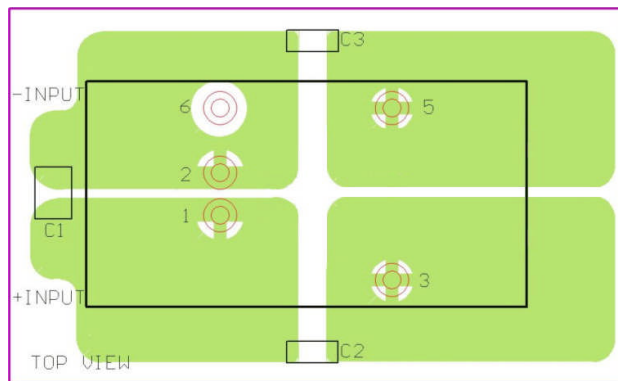

Recommended layout with input filter

To meet conducted emissions EN55022 CLASS A the following components are needed:

PXD10-24WSxx

Component	Value	Voltage	Reference
C1	1µF	50V	1210 MLCC
C2, C3	1000pF	2KV	1808 MLCC

PXD10-48WSxx

Component	Value	Voltage	Reference
C1	1.5µF	100V	1812 MLCC
C2, C3	1000pF	2KV	1808 MLCC

EMC considerations (Continued)

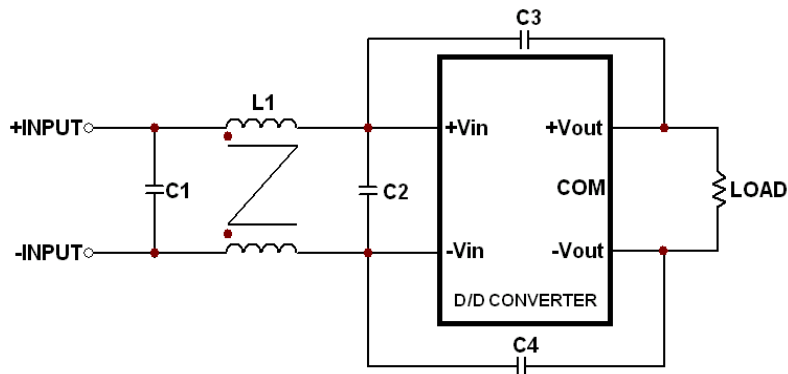

Suggested schematic for EN55022 conducted emission Class B limits

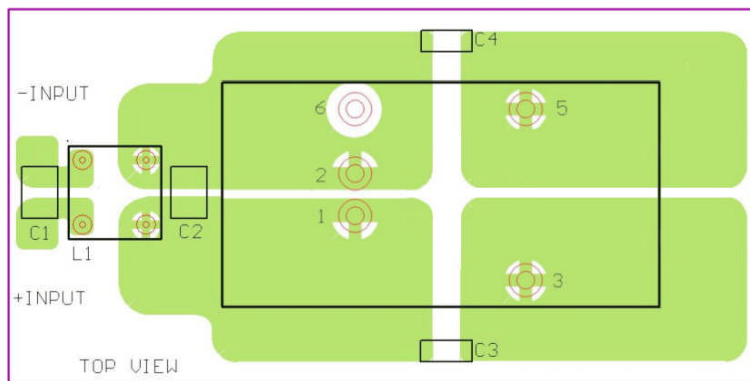

Recommended layout with input filter

To meet conducted emissions EN55022 CLASS B the following components are needed:

PXD10-24WSxx

Component	Value	Voltage	Reference
C1	2.2 μ F	50V	1812 MLCC
C3, C4	1000pF	2KV	1808 MLCC
L1	325 μ H	----	Common Choke

PXD10-48WSxx

Component	Value	Voltage	Reference
C1, C2	2.2 μ F	100V	1812 MLCC
C3, C4	1000pF	2KV	1808 MLCC
L1	325 μ H	----	Common Choke

Common Choke L1 is defined as follows:

- L-325 μ H \pm 35% / DCR-35m Ω , max
- A height: 8.8 mm, Max
- Test condition-100kHz / 100mV
- Recommended through hole- Φ 0.8mm
- All dimensions in millimeters

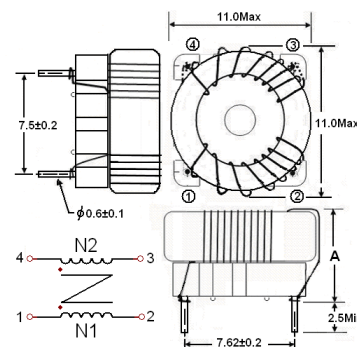

Input Source Impedance

The converter should be connected to a low impedance input source. Highly inductive source impedance can affect the stability of the converter. Input external L-C filter is recommended to minimize input reflected ripple current. The inductor is a simulated source impedance of 12 μ H and the capacitor is Nippon chemi-con KY series 100 μ F/100V. The capacitor must be located as close as possible to the input terminals of the converter for lowest impedance.

Output Over Current Protection

When excessive output currents occur in the system, circuit protection is required on all converters. Normally, overload current is maintained at approximately 150 percent of rated current for PXF40-xxSxx series.

Hiccup-mode is a method of operation in a converter whose purpose is to protect the power supply from being damaged during an over-current fault condition. It also enables the converter to restart when the fault is removed. There are other ways of protecting the converter when it is over-loaded, such as the maximum current limiting or current foldback methods.

One of the problems resulting from over current is that excessive heat may be generated in power devices; especially MOSFET and Schottky diodes and the temperature of these devices may exceed their specified limits. A protection mechanism has to be used to prevent these power devices from being damaged.

The operation of hiccup is as follows. When the current sense circuit sees an over-current event, the controller shuts off the converter for a given time and then tries to start up the converter again. If the over-load condition has been removed, the converter will start up and operate normally; otherwise, the controller will see another over-current event and will shut off the converter again, repeating the previous cycle. Hiccup operation has none of the drawbacks of the other two protection methods, although its circuit is more complicated because it requires a timing circuit. The excess heat due to overload lasts for only a short duration in the hiccup cycle, hence the junction temperature of the power devices is much lower.

Output Over Voltage Protection

The output over-voltage protection consists of an output Zener diode that monitors the voltage on the output terminals. If the voltage on the output terminals exceeds the over-voltage protection threshold, then the Zener diode clamps the output voltage.

Short Circuit Protection

Continuous, hiccup and auto-recovery mode.

Thermal Consideration

The converter operates in a variety of thermal environments; however, sufficient cooling should be provided to help ensure reliable operation of the unit. Heat is removed by conduction, convection, and radiation to the surrounding environment. Proper cooling can be verified by measuring the point as shown in the figure below. The temperature at this location should not exceed 100°C. When Operating, adequate cooling must be provided to maintain the test point temperature at or below 100°C. Although the maximum point temperature of the power modules is 100°C, lowering this temperature yields higher reliability.

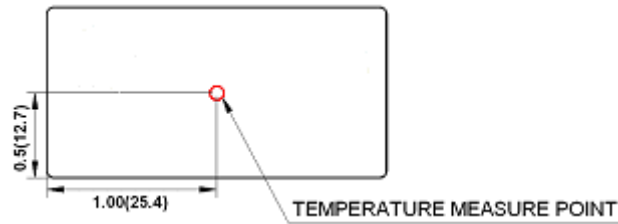

Measurement shown in inches(mm)

TOP VIEW

Remote ON/OFF Control (Option)

Remote control is an optional feature.

Positive logic:

Turns the module On during logic High on the On/Off pin and turns Off during logic Low.

Negative logic:

Turns the module On during logic Low on the On/Off pin and turns Off during logic High.

The On/Off pin is an open collector/drain logic input signal ($V_{on/off}$) that referenced to $-V_{IN}$.

Remote On/Off Implementation

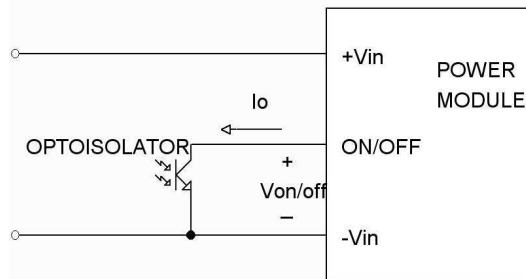

Isolated-Control Remote On/Off

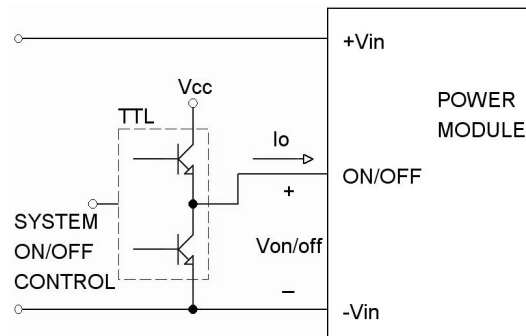

Level Control Using TTL Output

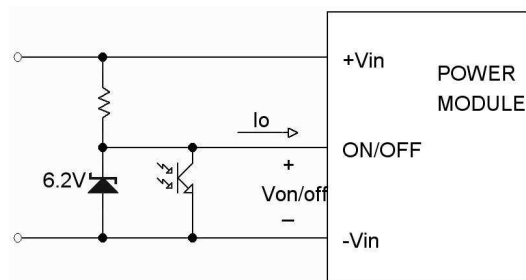

Level Control Using Line Voltage

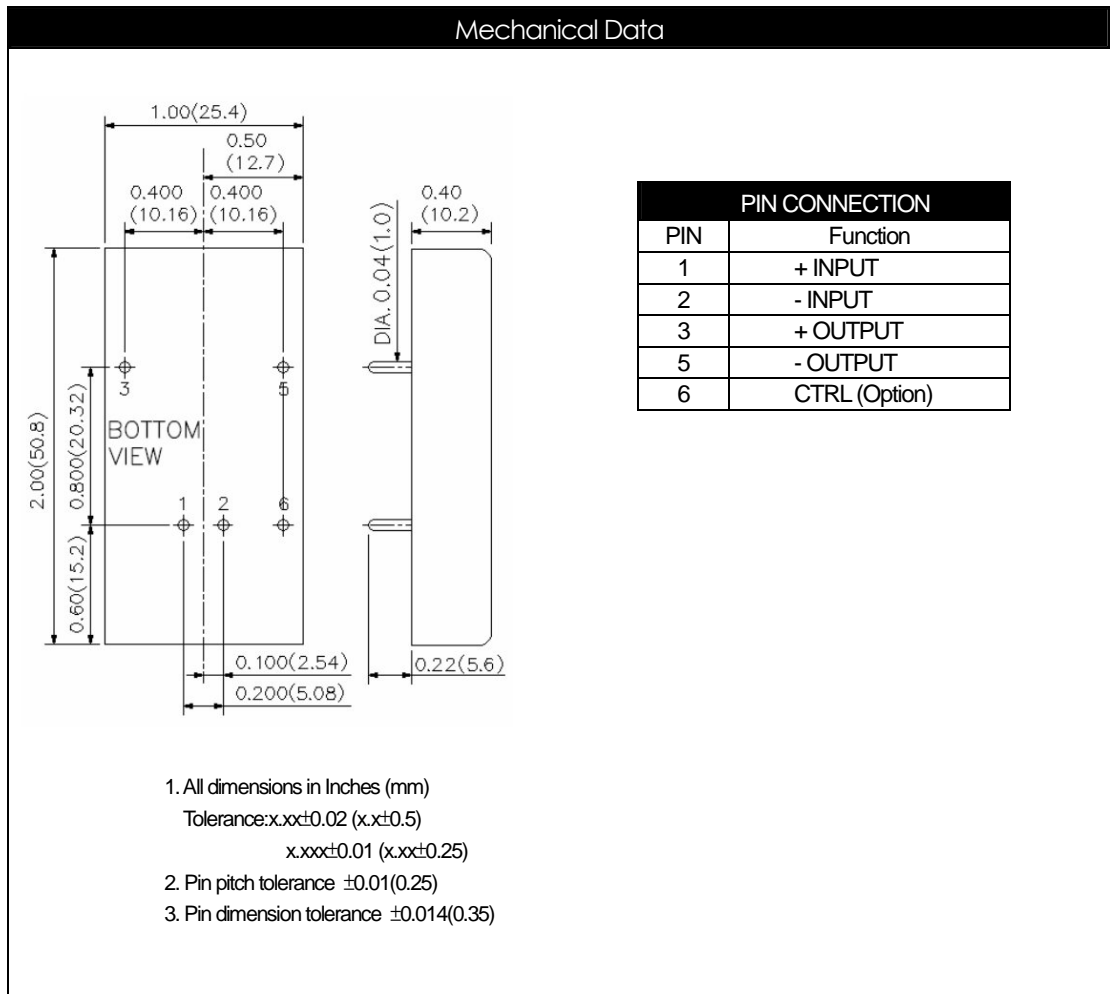
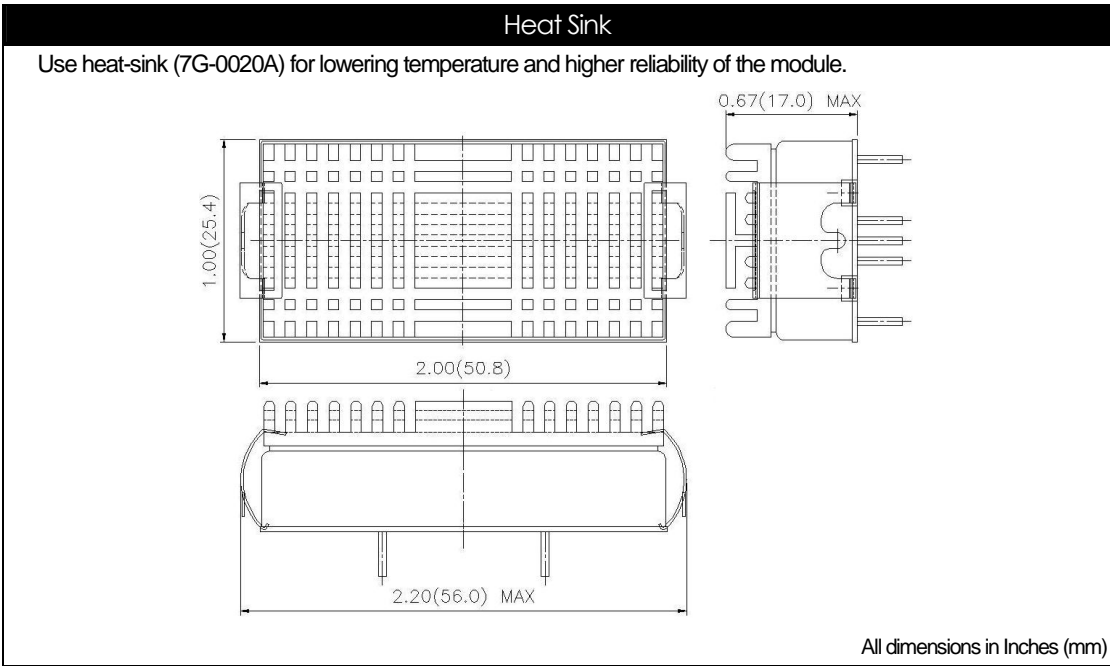

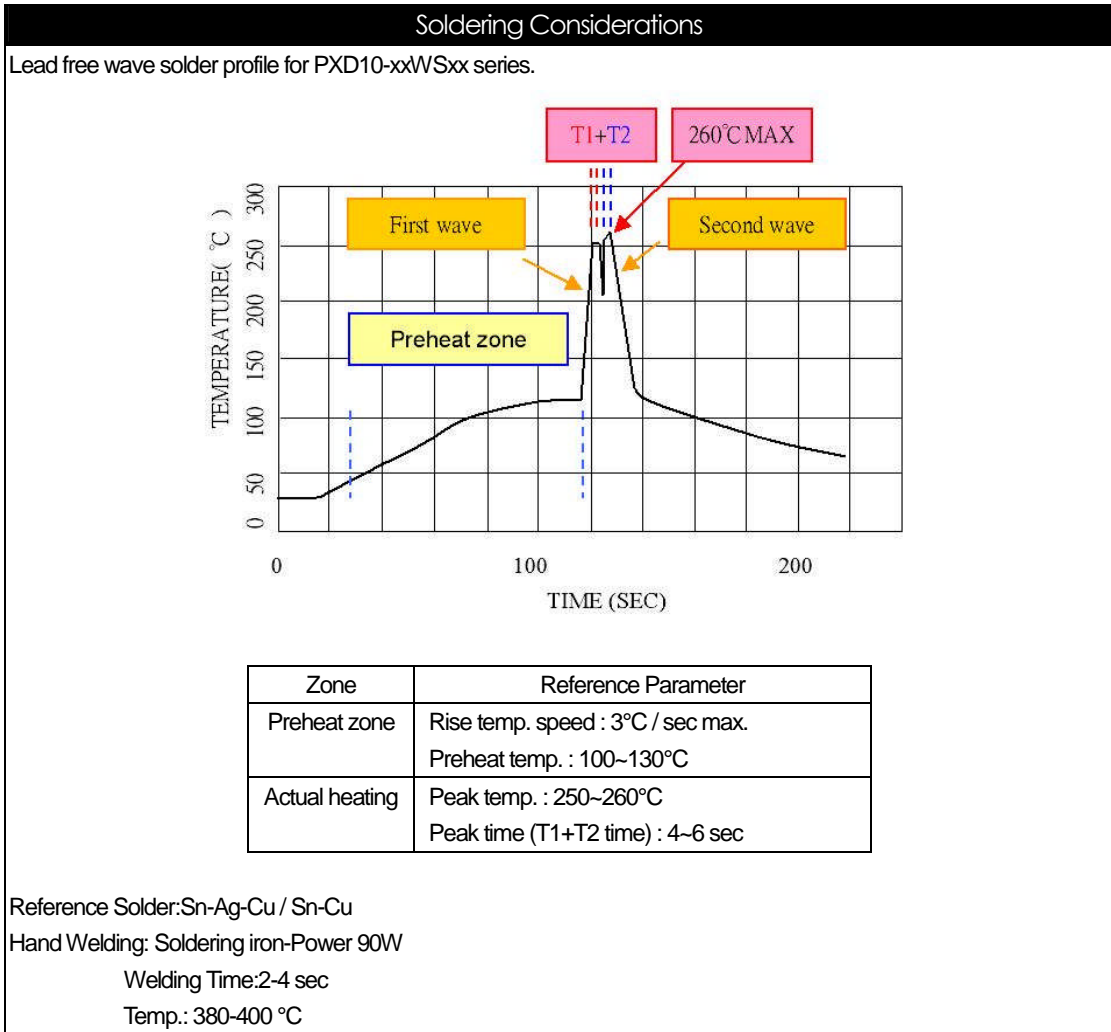
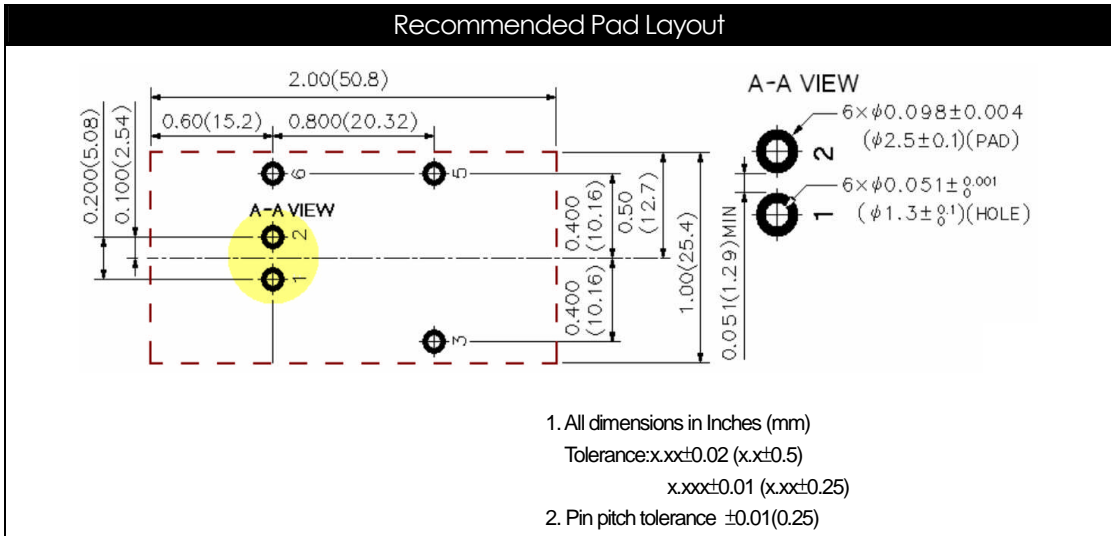

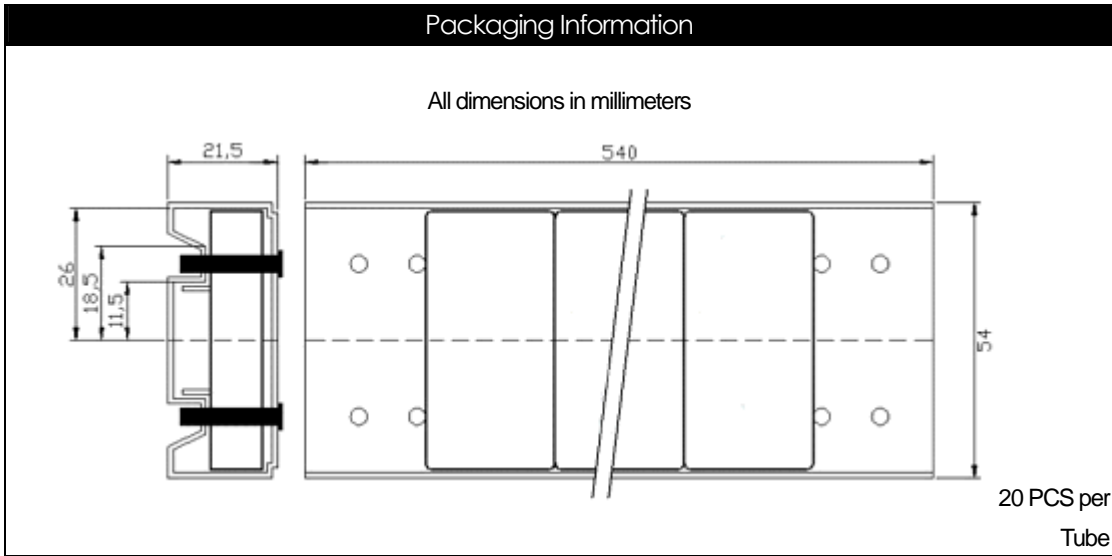

Part Number Structure

PXD 10 - 48 WS 05 - P

Max. Output Power
10 Watts

Input Voltage Range
24 9 ~ 36V
48 18 ~ 75V

4:1 Ultra Wide Input Range

Single Output

Output Voltage
3P3 3.3VDC
05 5VDC
12 12VDC
15 15VDC

Remote Control
No Suffix: Without Remote Control
Suffix -P: Positive Logic
Suffix -N: Negative Logic

Model Number	Input Range	Output Voltage	Output Current Max. Load	Input Current Full Load ⁽¹⁾	Eff ⁽²⁾ (%)
PXD10-24WS3P3	9 - 36 VDC	3.3VDC	2500mA	465mA	78
PXD10-24WS05	9 - 36 VDC	5VDC	2000mA	548mA	80
PXD10-24WS12	9 - 36 VDC	12VDC	830mA	519mA	84
PXD10-24WS15	9 - 36 VDC	15VDC	670mA	544mA	81
PXD10-48WS3P3	18 - 75 VDC	3.3VDC	2500mA	239mA	76
PXD10-48WS05	18 - 75 VDC	5VDC	2000mA	270mA	81
PXD10-48WS12	18 - 75 VDC	12VDC	830mA	259mA	84
PXD10-48WS15	18 - 75 VDC	15VDC	670mA	262mA	84

Note 1. Maximum value at nominal input voltage and full load of standard type.
 Note 2. Typical value at nominal input voltage and full load.

Safety and Installation Instruction**Fusing Consideration**

Caution: This converter is not internally fused. An input line fuse must always be used.

This encapsulated converter can be used in a wide variety of applications, ranging from simple stand-alone operation to an integrated part of a sophisticated power architecture. For maximum flexibility, internal fusing is not included; however, to achieve maximum safety and system protection, always use an input line fuse. The safety agencies require a slow-blow fuse with maximum rating of 5A. Based on the information provided in this data sheet on Inrush energy and maximum dc input current; the same type of fuse with lower rating can be used. Refer to the fuse manufacturer's data for further information.

MTBF and Reliability**The MTBF of PXD10-xxWSxx series of DC/DC converters has been calculated using**

Bellcore TR-NWT-000332 Case I: 50% stress, Operating Temperature at 40°C (Ground fixed and controlled environment). The resulting figure for MTBF is 1.976×10^6 hours.

MIL-HDBK 217F NOTICE2 FULL LOAD, Operating Temperature at 25°C. The resulting figure for MTBF is 1.416×10^6 hours.