

## Content

1. Description
2. Power and Ground Planes

## Description

The SLG59M1603V is 16 mΩ, ~ 4.5 A dual-channel load switch that is able to switch 1.0 to 5.5 V power rails. The product is packaged in an ultra-small 1 x 3 mm package.

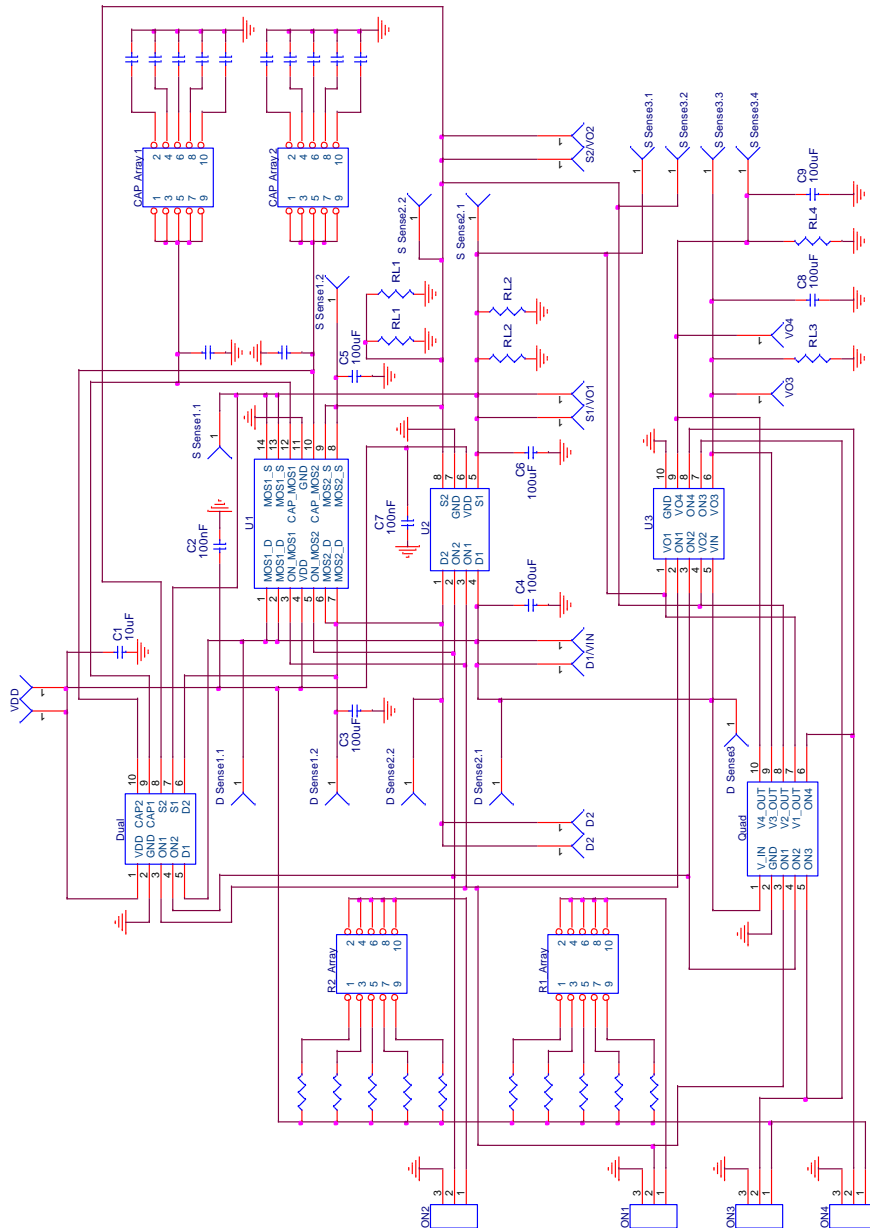

**Figure 4. SLG59M1603V Connection Circuit**

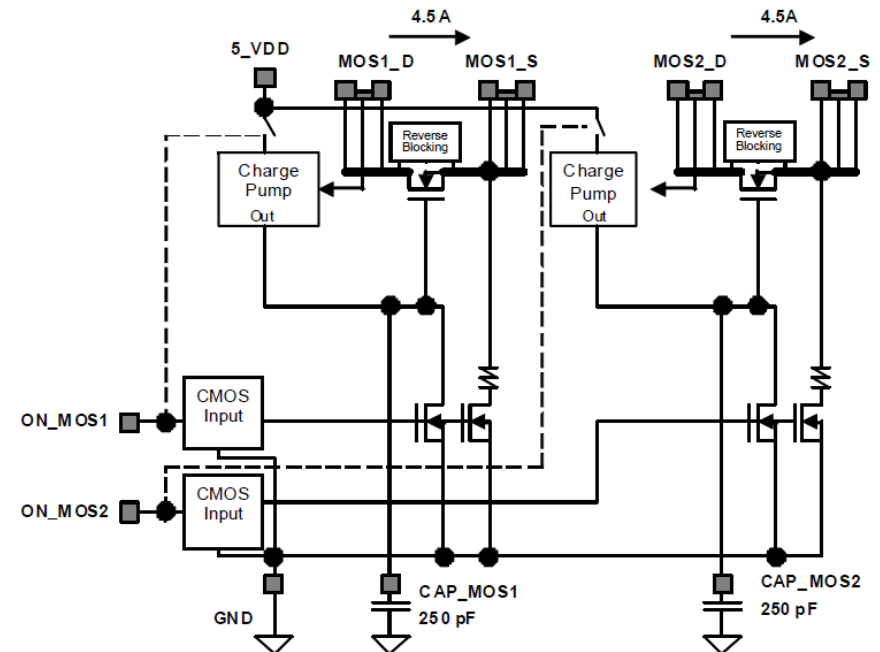
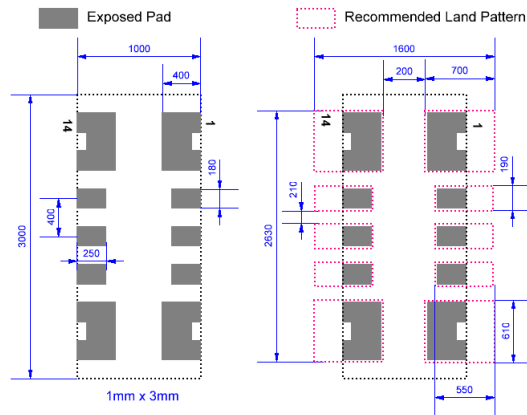

**Figure 1: SLG59M1603V Block Diagram**

This layout guide provides some important information about the PCB layout of SLG59M1603V applications.

### SILEGO STDFN 1 x 3 - 14L PKG

Unit: um



**Figure 2. SLG59M1603V Package Dimensions and Recommended Land Pattern**

Please solder your SLG59M1603V here

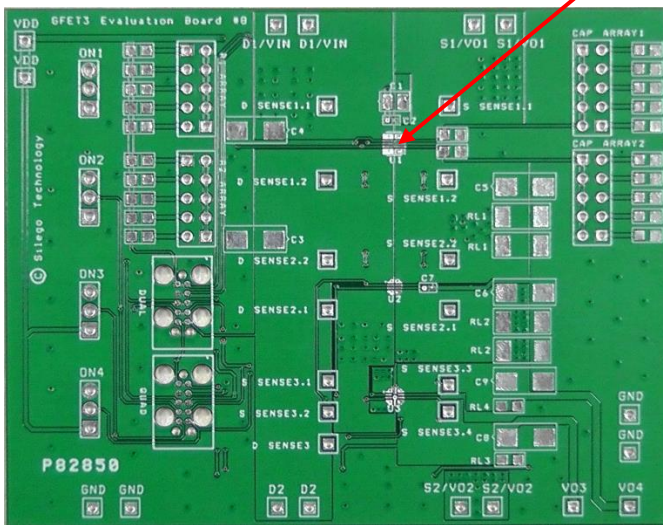

**Figure 3. SLG59M1603V Evaluation Test Board**

Note: Evaluation board has D\_Sense and S\_Sense pads. Please use them only for RDS(ON) evaluation.

## 2. Power and Ground Planes

2.1. The VDD pin needs 0.1uF external capacitor to smooth pulses from the power supply. Locate these capacitor close to PIN4.

2.2. The trace length from the control IC to the ON pins should be as short as possible and must avoid crossing this trace with power rails.

2.3. The D and S pins carry significant current. Please note how the D and S pads are placed directly on the power planes in Figure 3, which minimizes the RDS(ON) associated with long, narrow traces. The D and S pins dissipate most of the heat generated during high-load current condition. The layout shown in Figure 3 is illustrating a proper solution for heat to transfer as efficiently as possible out of the device.

2.4. The GND pin (PIN11) should be connected to GND.

2.5. 2 oz. copper is recommended for higher currents.