

Sensor/actuator box - SACB-4/ 4- 5,0PUR SCO P - 1452398

Please be informed that the data shown in this PDF Document is generated from our Online Catalog. Please find the complete data in the user's documentation. Our General Terms of Use for Downloads are valid (<http://phoenixcontact.com/download>)



Sensor/actuator box, application: Standard, connection method: M12-SPEEDCON-socket Plastic, number of slots: 4, number of positions: 4, coding: A-coded, slot assignment: single, status display: No, Universal; master cable connection: Fixed connection 180°, PUR/PVC, cable length: 5 m, shielding: no

Figure shows version with diagnostic and status indicator

Why buy this product

- Safety in the field, thanks to molded housing and high degree of protection
- Flexible, distributed bundling of signals in one master cable
- Save time, thanks to installation with SPEEDCON fast locking system



Key Commercial Data

Packing unit	1 STK
GTIN	 4 046356 553780
GTIN	4046356553780

Technical data

General

Rated voltage	120 V
Current carrying capacity per I/O signal	2 A
Current carrying capacity per slot	4 A
Total rated current	12 A
Number of positions	4
Number of slots	4
Flammability rating according to UL 94	V0
Sensor/actuator connection system	M12-SPEEDCON-socket

Ambient conditions

Degree of protection	IP65
	IP67

Sensor/actuator box - SACB-4/ 4- 5,0PUR SCO P - 1452398

Technical data

Ambient conditions

Ambient temperature (operation)	-25 °C ... 80 °C
	-40 °C ... 90 °C (for fixed installation)
	-5 °C ... 80 °C (for flexible installation)

Master cable connection data

Connection method	Fixed connection
Length of cable	5 m
Tightening torque slot sensor/actuator cable	0.4 Nm
Tightening torque of mounting screw for fixing the housing	0.5 Nm

Insulation material

Housing material	PBT
Material of the moulding mass	PUR
Contact material	Cu alloy
Contact surface material	gold-plated
Contact carrier material	PA
Material of threaded sleeve	PBT
O-ring material	NBR

Pin assignment

Slot/position = Wire color or connection	1 / 4 (A) = WH
	2 / 4 (A) = GN
	3 / 4 (A) = YE
	4 / 4 (A) = GY
	1-4 / 1 (+ 120 V) = BN
	1-4 / 3 (0 V) = BU
	1-4 / 5 (PE) = GN/YE

Standards and Regulations

Standard designation	M12 connector
Standards/regulations	IEC 61076-2-101
Connection in acc. with standard	CUL
Flammability rating according to UL 94	V0

Cable

Cable type	PUR/PVC black
Cable type (abbreviation)	PUR
Cable abbreviation	LiYY11Y-HF
UL AWM style	20549
Conductor cross section	4x 0.34 mm ² (Signal line)
	3x 0.75 mm ² (power line)
AWG signal line	22
AWG power supply	18

Sensor/actuator box - SACB-4/ 4- 5,0PUR SCO P - 1452398

Technical data

Cable

Conductor structure signal line	19x 0.15 mm
Conductor structure, voltage supply	42x 0.15 mm
Core diameter including insulation	1.3 mm ±0.1 mm (Signal line)
	1.8 mm ±0.1 mm (power line)
Wire colors	brown, blue, green/yellow, white, green, yellow, gray
Overall twist	Wires twisted in layers
External sheath, color	black RAL 9005
Inner sheath thickness	≥ 0.15 mm
Outer sheath thickness	≥ 0.38 mm
External cable diameter D	6.9 mm ±0.2 mm
Minimum bending radius, fixed installation	7.5 x D
Minimum bending radius, flexible installation	10 x D
Number of bending cycles	1500000
Bending radius	69 mm
Traversing path	2 m
Traversing rate	2 m/s
Cable weight	77.9 kg/km
Outer sheath, material	PUR
Material, inner sheath	PVC
Material conductor insulation	PVC
Conductor material	Bare Cu litz wires
Nominal voltage, cable	300 V
Test voltage, cable	2000 V
Special properties	Silicone-free
Flame resistance	DIN EN 50265
Resistance to oil	according to VDE 0472 Part 803
Other resistance	Highly resistant to acids, alkaline solutions and solvents
Ambient temperature (operation)	-40 °C ... 90 °C (cable, fixed installation)
	-5 °C ... 80 °C (cable, flexible installation)

Environmental Product Compliance

China RoHS	Environmentally friendly use period: unlimited = EFUP-e
	No hazardous substances above threshold values

Drawings

Sensor/actuator box - SACB-4/ 4- 5,0PUR SCO P - 1452398

Schematic diagram

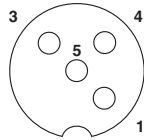

M12 slot, socket, 4-pos.

Cable cross section

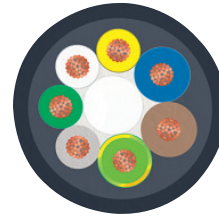

PUR/PVC black [PUR]

Dimensional drawing

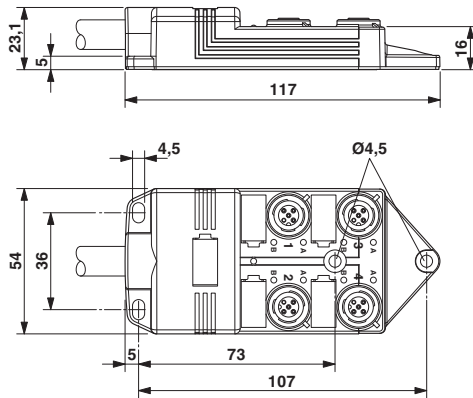

Circuit diagram

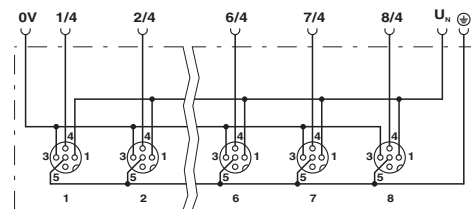

Approvals

Approvals

Approvals

UL Recognized / cUL Recognized / EAC / cULus Recognized

Ex Approvals

Approval details

UL Recognized		http://database.ul.com/cgi-bin/XYV/template/LISEXT/1FRAME/index.htm	FILE E 118976
Nominal voltage UN	120 V		

Sensor/actuator box - SACB-4/ 4- 5,0PUR SCO P - 1452398

Approvals

cUL Recognized		http://database.ul.com/cgi-bin/XYV/template/LISEXT/1FRAME/index.htm	FILE E 118976
Nominal voltage UN		120 V	

EAC		EAC-Zulassung
-----	---	---------------

cULus Recognized		http://database.ul.com/cgi-bin/XYV/template/LISEXT/1FRAME/index.htm
------------------	---	---

Phoenix Contact 2018 © - all rights reserved
<http://www.phoenixcontact.com>

PHOENIX CONTACT GmbH & Co. KG
Flachsmarktstr. 8
32825 Blomberg
Germany
Tel. +49 5235 300
Fax +49 5235 3 41200
<http://www.phoenixcontact.com>