

# PHA Short Stroke Push-Button Switch

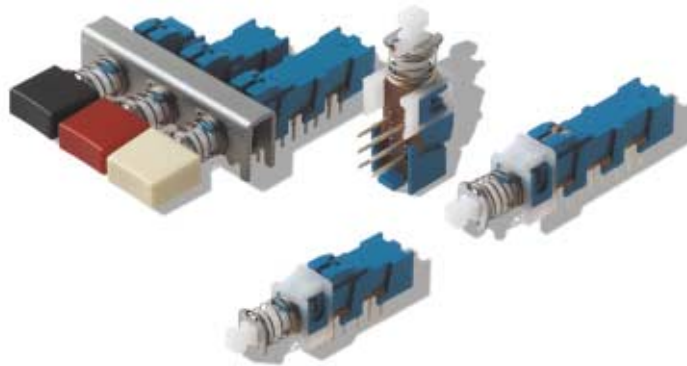

The push-button switch PHA with small dimensions make it the ideal choice for today's demanding switch requirements

- PC pins in the module grid of  $2.5 \times 2.5$  mm (0.0984  $\times$  0.0984). Chassis on request.
- Operating force only 170 cN (170 grams) (with 2 poles)
- Sealed, designed for flow soldering
- 2, 4 or 6 pole, double throw switching
- Optionally momentary (OA) or push-push (EE) function and interlocking (GR) in a chassis. A mixture of these different functions is possible
- Single module with chassis: see next page

## Button Removal

A button of a push-push button switch is only allowed to be removed in "OFF" (non-latching) position.

### Construction

Function	Momentary (OA), push-push (EE) or interlocking (GR)
Number of modules in a chassis	1 up to 10
Contact arrangement	2U, 4U or 6U (U = changeover)
Mode of switching	Non-shorting
Distance between button centers	10, 12.5, 15, 17.5, 20 mm (0.394, 0.492, 0.591, 0.689, 0.787 inch)
Contacts	PC pins in module grid $2.5 \times 2.5$ mm (0.0984 $\times$ 0.0984 inch)

### Electrical data

Switching power max.	3 W DC
Switching voltage max.	30 V DC
Switching current max.	100 mA DC
Dielectric strength (50 Hz/1 Min.)	500 V between open contacts 1500 V between chassis and contacts
Operating life impulse/momentary (OA)	$\cong 10^4$ operations
latching (EE)	$\cong 10^4$ operations
Contact resistance new	$\cong 20$ m $\Omega$
after $10^5$ operations	$\cong 40$ m $\Omega$
Insulation resistance	$\cong 10^{10}$ $\Omega$
Capacitance	$\cong 1.5$ pF
Contact bounce	$\cong 2$ ms
Operating speed 200 mm/s (7.87 inch/s)	

### Mechanical data

Total travel/latching travel	2.5 mm/1.5 mm (0.0984 inch/0.0591 inch)
Operating force	for 2U: 170 cN $\pm$ 50 cN (170 grams $\pm$ 50 grams) 4U: 230 cN $\pm$ 70 cN (230 grams $\pm$ 70 grams) 6U: 300 cN $\pm$ 100 cN (300 grams $\pm$ 100 grams)
Sealing	Sealed contacts

### Further data

Contact material	AG
Insulation material of housing and actuator	Thermoplastic
Max. soldering time and temperature	5 s at 260°C
Operating temperature	- 10°C to + 60°C

Ordering code: see next page.

# PHA Short Stroke Push-Button Switch

## Dimensional Drawings

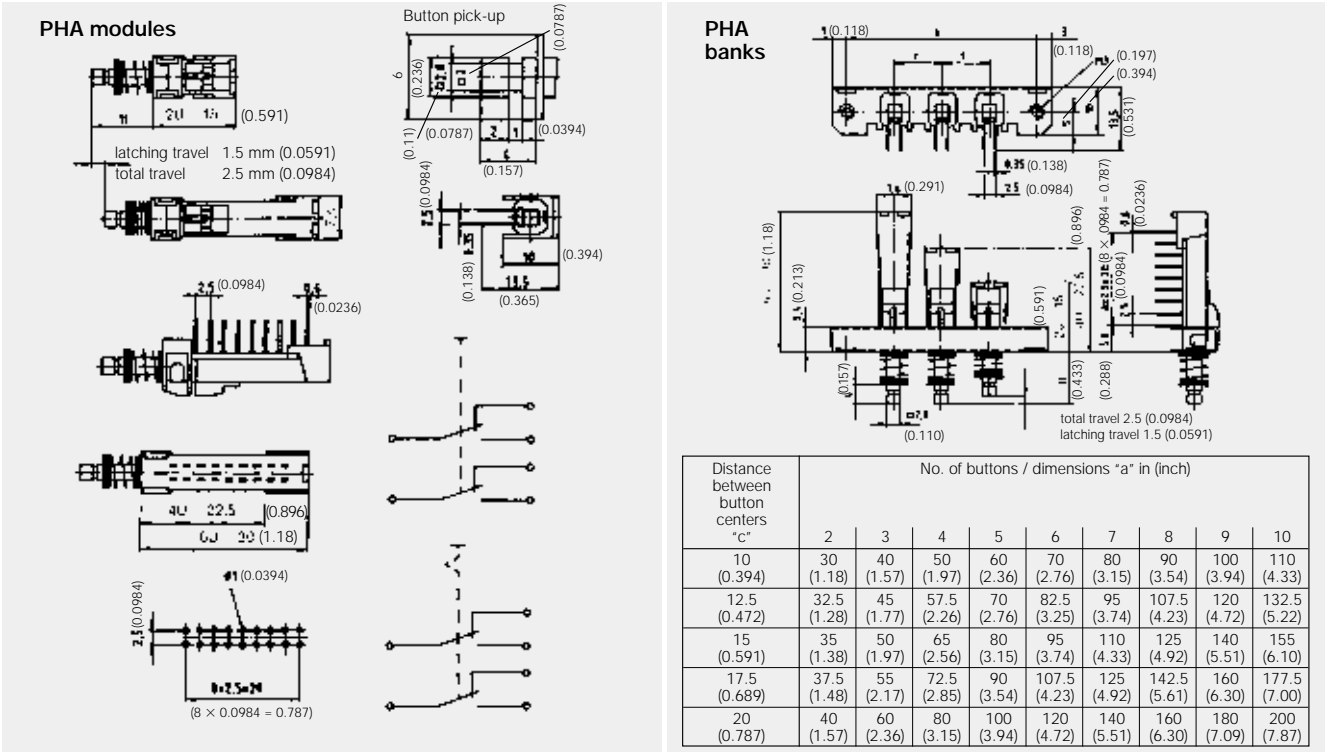

Button G001 indexed spacing min. 10 mm (0.394 inch)

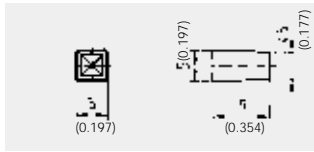

Button G003 round spacing min. 10 mm (0.394 inch)

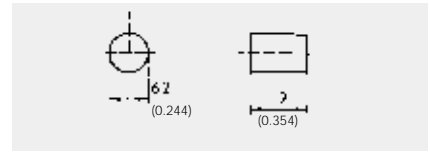

Button G002 rectangular spacing min. 10 mm (0.394 inch)

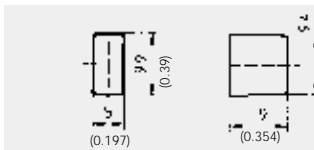

Button G004 square spacing min. 10 mm (0.394 inch)

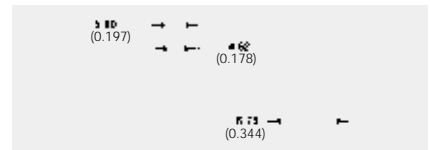

Button colors: black, grey, red, ivory, blue

Ordering code	1	2	3	4	5	6	7
	<b>Example:</b>	2×PHA	12.5	G01	RD	4U	GR ChM3
<b>1</b>	<b>Designation:</b> PHA = module without chassis, 1 × PHA to 10 × PHA = bank with 1 to 10 modules	→	→	→	→	→	→
<b>2</b>	<b>Spacing in mm:</b> 10, 12.5, 15, 17.5, 20 (0.394, 0.492, 0.591, 0.689, 0.787 inch), none = module	→	→	→	→	→	→
<b>3</b>	<b>Button type:</b> G01 = indexed, G02 = rectangular, G03 = round, G04 = square	→	→	→	→	→	→
<b>4</b>	<b>Button color:</b> BK = black, IY = ivory, GY = grey, RD = red, BU = blue	→	→	→	→	→	→
<b>5</b>	<b>Contact arrangement:</b> 2U = 2 changeovers, 4U, 6U, shorting: add KS (e.g. 2UKS)	→	→	→	→	→	→
<b>6</b>	<b>Mechanical function:</b> OA = momentary, EE = push-push, GR = interlocking	→	→	→	→	→	→
<b>7</b>	<b>Chassis:</b> on request	→	→	→	→	→	→

# F and SF Push-Button Switches

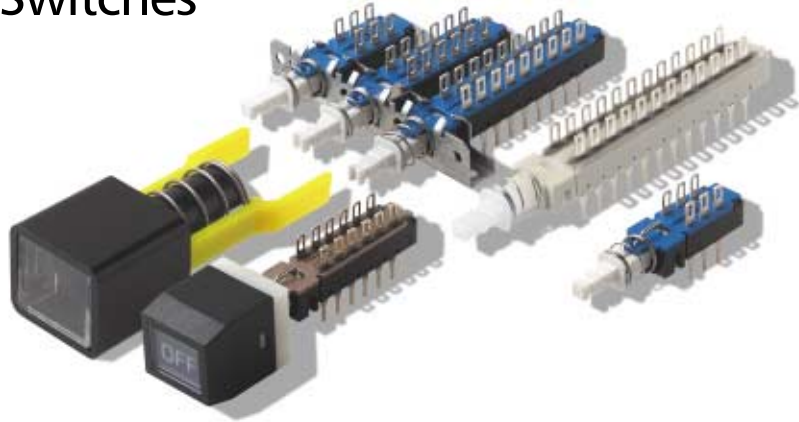

The essential features of the F and SF push-button switch are the bridge contact and the many mechanical functions. The contact bridge is spring loaded which guarantees a constant pressure on the contacts.

- Up to 10 poles per module
- Various contact terminals
- Standard mounting frame with max. 23 positions
- Spacing optionally 10, 12.5, 15, 17.5 or 20 mm
- Independent interlocking groups in one bank possible
- Mechanical indicator buttons
- Configurations with illuminated push-buttons

## Mechanical functions

- OA** Momentary returning to normal "OFF" position
- EE** Push-push function
- GR** Interlocking
- GR1+ GR2** Two independent interlocking groups in one bank
- AOR** Release push-button for a bank, not latching

### Button Removal

A button of a push-push button switch is only allowed to be removed in "OFF" (non-latching) position.

Construction		
Function	Momentary (OA), push-push (EE), further functions: see table to the left	
Number of buttons	1 up to 23	
Contact arrangement (U = changeover contact)	Series F: 2U, 4U, 6U, 8U, 10U Series SF: 2U, 4U, 6U, 8U	
Mode of switching	Non-shorting	
Illumination	See: indicator and illuminated push-buttons	
Spacing	10, 12.5, 15, 17.5 or 20 mm (0.394, 0.492, 0.591, 0.689 or 0.787 inch)	
Terminals (see next page)	PC pins and soldering lugs or only PC pins	
Electrical data		
	F-Silver	F-Gold
Switching power	F module max. AC/DC 50 VA/15 W	1 VA/300 mW
Switching voltage	F module max. AC/DC 125/30 V	50/30 V
Switching current	F module max. AC/DC 0.5/0.5 A	0.04 A/0.01 A
Carrying current max. at $\delta u = 20^\circ\text{C}$	< 2 A	< 0.5 A
Dielectric strength (50 Hz, 1 Min.)	Chassis/contact	$\cong 1500$ V
	Between contacts	$\cong 1500$ V
Operating life <sup>1)</sup> (24 V/200 mA)	"OA/EE"	> $10^5$ operations
	"GR"	> $3.5 \times 10^4$ operations
Contact resistance	initial	Typical $\leq 10$ m $\Omega$ , max. 20 m $\Omega$
	after operating life	$\leq 100$ m $\Omega$
Insulation resistance		$\cong 10^9$ $\Omega$ between open contacts
		$\cong 10^9$ $\Omega$ between chassis and contacts
Capacitance at f = 10 kHz	$\cong 0.7$ pF between 2 contacts	
Mechanical data		
Total travel/latching travel	4.7 mm/3.3 mm (0.185 inch/0.130 inch)	
Typical F Operating Force	2U = 6.5N (650 grams)	
	4U = 6.5N (650 grams)	
	6U = 7.5N (750 grams)	
	8U = 9.0N (900 grams)	
	10U = 9.0N (900 grams)	
European Typical SF Operating Force	2U = 3.5N $\pm$ 0.5N (350 grams $\pm$ 50 grams)	
	4U = 5N $\pm$ 1N (500 grams $\pm$ 100 grams)	
	6U = 6.5N $\pm$ 1N (650 grams $\pm$ 100 grams)	
	8U = 9N $\pm$ 1N (900 grams $\pm$ 100 grams)	
Further data		
Contact and insulation material	Contacts	Housing
	Silver with Ni-junction	Thermoplastic
Max. soldering time and temperature	Gold with Ni-junction	Thermoplastic
	5 s at 260°C · hand soldering 3 s at 350°C	
Operating temperature	- 40°C to + 70°C	

<sup>1)</sup> 25 - 30 operations/Min.

Ordering code: see page C-15.

# F and SF Push-Button Switches

## Contact Styles

### Standard arrangement

Solder lugs top,  
PC pins bottom

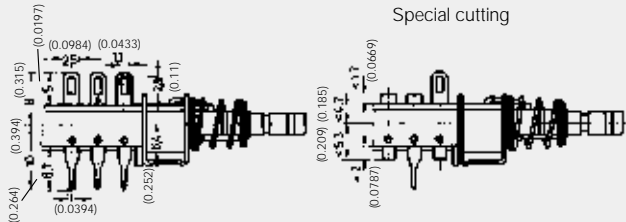

### PC board layout

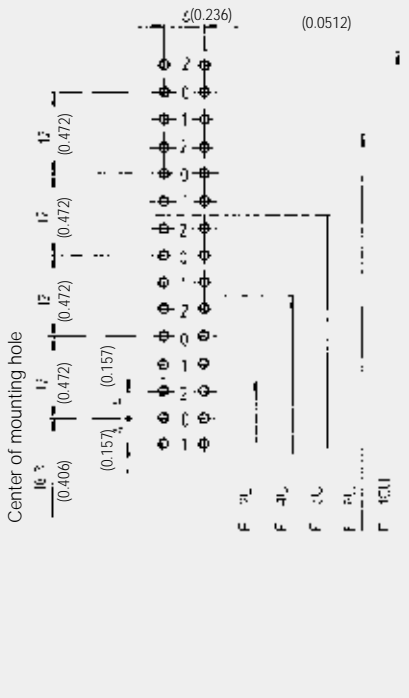

### Circuit diagram: momentary

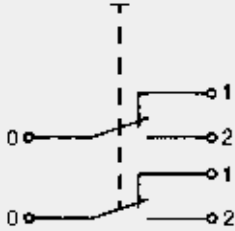

### Circuit diagram: push-push

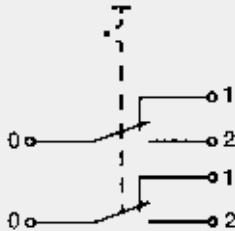

Standard chassis: see page C-15, non-standard chassis: consult factory.

Terminal Code	US	Europe
Solder Lug & P.C. Pins (standard)	01	
Cut Solder Lugs	01A	P
Cut PC Pins	01B	L





# NE18 and NE18CTII Mains Switches

Ordering code - USA		1	2	3	4	5	6	7	8	9	10	11	12	13	14	
		<b>Example:</b>	F	17.5	06	4U	EE	TB	F210103	N	01	B	AU	1	01	Station 2 = OA
<b>1</b>	<b>Designation:</b> F, F/LT	→														
<b>2</b>	<b>Spacing</b> (if required for chassis <sup>1)</sup> ): 10 = 10 mm (0.394 inch), 12.5 = 12.5 mm (0.492 inch), 15 = 15 mm (0.590 inch), 17.5 = 17.5 mm (0.689 inch), 20 = 20 mm (0.787 inch)	→														
<b>3</b>	<b>Number of stations:</b> 00 = no chassis, 01 thru 23	→														
<b>4</b>	<b>Number of poles:</b> 2U = 2PDT, 4U = 4PDT, 6U = 6PDT, 8U = 8PDT, 10U = 10PDT	→														
<b>5</b>	<b>Mechanical function:</b> GR = interlock, OA = momentary, EE = push-push, AOR = central release, OA + SP = momentary/lockout, <sup>2)</sup> GR + SP = interlock/lockout, <sup>2)</sup> X = mixed (see page C-12)	→														
<b>6</b>	<b>Terminal sealing:</b> TB = top/bottom, N = none	→														
<b>7</b>	<b>Button style and color:</b> see pages C-18 to C-20 or C-21 for coding	→														
<b>8</b>	<b>Power switches:</b> see page D-13	→														
<b>9</b>	<b>Terminal style:</b> 01 = solder lugs top and PC pins bottom, for additional configuration consult factory.	→														
<b>10</b>	<b>Electrical function:</b> B = BBM	→														
<b>11</b>	<b>Contact material:</b> AU = gold, AG = silver	→														
<b>12</b>	<b>Lamp holder style:</b> see page C-21	→														
<b>13</b>	<b>Lamp type incandescent:</b> 01 = 6 V, 02 = 12 V, 03 = 24 V	→														
<b>14</b>	<b>Special acknowledgements:</b> if all stations are not identical, please state requirements	→														

<sup>1)</sup> If option not required: fill in with an N <sup>2)</sup> lockout available with 10,15 and 17.5 mm spacing. <sup>3)</sup> Switch Orientation: Plunger toward you, solder lugs up, station #1 far left.

# Central Mounted F-Modules

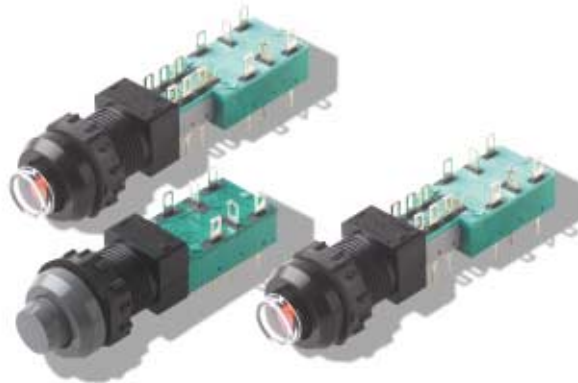

Single modules of the F Series including mains/power modules NE18 and NE18CTII are available with central mounting.

### Standard Designs:

- ZF12 with threaded mounting M 12 × 0.75 and a metal knurled nut.
- ZF with threaded mounting M 14 × 1 optional with threaded plastic front panel or with knurled nut.
- ZFA like ZF but with indication button FA200.
- ZFL like ZF but with illuminated push-buttons FLB or FLC or FLC-LED.  
ZFL: you can select among these three illumination possibilities.

US F11 Europe FA200



F24 F200



F25 FLC



Ordering code: see next page.



### Dimensional Drawings

With FG button: hole  $\varnothing$  12 mm (.472 inch)

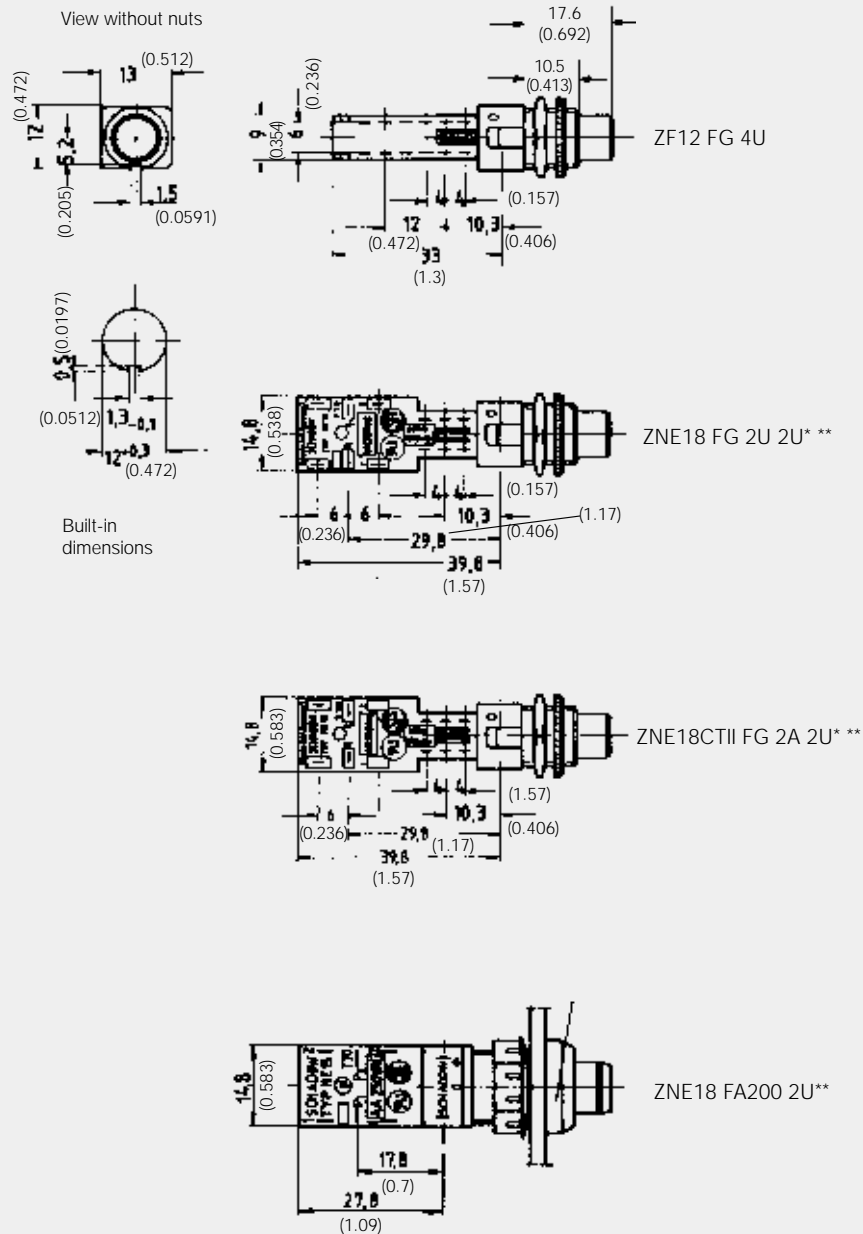

\* with auxiliary contacts  
\*\* consult factory for availability

ZF, ZG, ZNE18, ZNE18CTII with button FG (12 mm (0.472) diameter)

Cannon

Dimensions are shown in mm (inch)  
Dimensions subject to change

www.ittcannon.com



# Central Mounted F-Modules

## Button styles

Series ZF12	With button FG Ø 12 mm (0.472)
Series ZF	With button F200 Ø 14 mm (0.551)
Series ZFA*	With button FA200 Ø 14 mm (0.551)
Series ZFL*	With button FLB, FLC, FLC-LED You can select among these three illumination possibilities

\* Please indicate color of button and indicator.

## Illuminated buttons

Type FLB	With filament lamp
Button shell	Black, white, grey
Cap	Red, yellow, green, white
Lamps	12 V/40 mA
Type FLC	With Neon lamp
Button shell	Black, white, grey
Cap	Red, white, green, chrome, yellow
Lamps	Neon glow lamp Z-300-GL2 <sup>1)</sup>
Type FLD	With LED
Button shell	Black, white, grey
Cap	Red, green, yellow
LED	Red, green, yellow

<sup>1)</sup> Recommended series resistors:  
for 110 V 56 kΩ  
for 220 V 150 kΩ

## Lampholders

Type LZ1  
Illumination with push-button in depressed position.

Type LZ2  
Illumination independent from button position.

## Dimensional Drawings

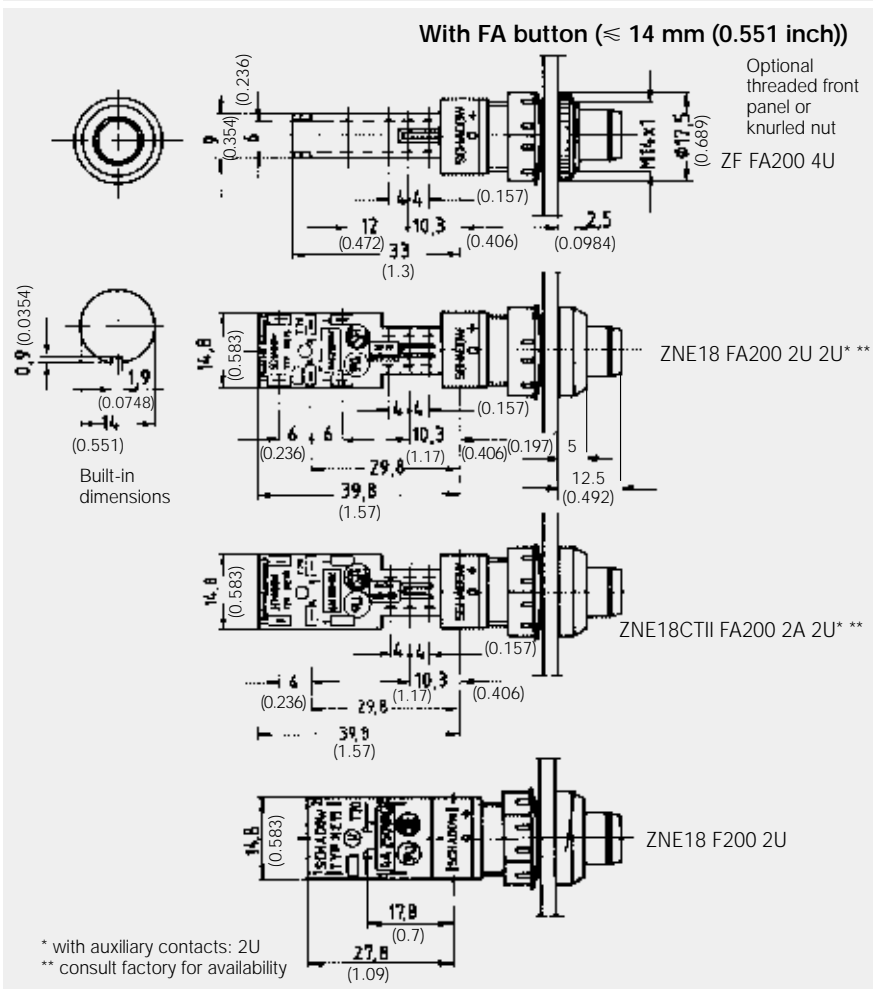

Push-button switches with central mounting: ZF, ZNE18 and ZNE18CTII with F200 or FA200 button (14 mm (0.551) diameter)

Ordering code		1	2	3	4	5	6	7	8	9
	<b>Example:</b>	ZF	LZ1	FLB	WH	RD		2U	EE	12 V
1	<b>Designation:</b> ZF, ZNE18, ZNE18CTII, ZF12 (only with FG button), ZFA = indicating push-button	→	→	→	→	→	→	→	→	→
2	<b>Indication, illumination:</b> none = without, none = indicating, LZ1 = illuminated in depressed position, LZ2 = illuminated independent from button position	→	→	→	→	→	→	→	→	→
3	<b>Button:</b> F200, FA200 = for indicating buttons, FG = only for ZF12, FLB (with filament lamp), FLC (with neon lamp), FLC-LED (with LED) = illuminated buttons	→	→	→	→	→	→	→	→	→
4	<b>Color of button housing:</b> BK = black, WH = white, GY = grey	→	→	→	→	→	→	→	→	→
5	<b>Color of illuminated button cap:</b> RD = red, GN = green; additionally: FLB: WH = white, FLC: WH = white,	→	→	→	→	→	→	→	→	→
6	<b>Color on ON-position of indicating buttons:</b> WH = white, YE = yellow, OG = orange, GN = green	→	→	→	→	→	→	→	→	→
7	<b>Contact arrangement</b> (U = changeover, A = make-contact): 2U, 2A, with additional 2 auxiliary contacts on request, 2U2U, 2A2U	→	→	→	→	→	→	→	→	→
8	<b>Mechanical function:</b> OA = momentary (LZ2 only OA), EE = latching/push-push (LZ1 and ZFA only EE)	→	→	→	→	→	→	→	→	→
9	<b>Lamp voltage of illuminated buttons:</b> 12 V	→	→	→	→	→	→	→	→	→

# F-Buttons

## Non-illuminated Buttons for F Series, PVF, Mains/Power Switches NE18 and NE18CTII

Overview of F-Buttons			
Designation	F	Mains Switches NE18, NE18CTII	Mounting on chassis
FMR	X	X	
FG	X	X	
F1.12-H-4	X <sup>3)</sup>	X	
F1.15-H-4	X <sup>3)</sup>	X	
F1.12-H-5	X <sup>3)</sup>	X	
FSC	X	X	
FSD	X	X	
FSB	X	X	
FE	X	X	
FA	X	X	
FSA	X	X	
FSR illuminated <sup>1)</sup>	X <sup>3)</sup>	X <sup>2)</sup>	
FVRB illuminated	X <sup>3)</sup>	X <sup>2)</sup>	
FA100 indicating	X <sup>3)</sup>	X	X
FA101 indicating	X <sup>3)</sup>	X	X
FA110 indicating	X <sup>3)</sup>	X	X
FA120 indicating	X <sup>3)</sup>	X	X
FA201 indicating	X <sup>3)</sup>	X	X

<sup>1)</sup> Vertical mounting only <sup>2)</sup> With auxiliary contacts (2U or 4U) only <sup>3)</sup> Not for PVA

### Dimensional Drawings

#### Designation: FMR

Diameter	7.2 mm
Length	12.5 mm
Pitch c. min.	10.0 mm
Colors	Black (BK), white (WH), grey (GY), orange (OG)

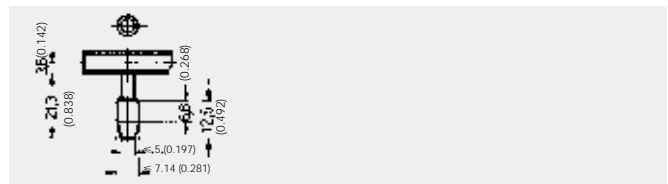

#### Designation: FG

Diameter	8.8 mm
Length	10.5 mm
Pitch c. min.	10.0 mm
Colors	Black (BK), white (WH), grey (GY), red (RD), green (GN), blue (BU)

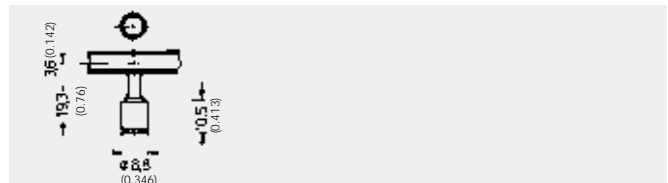

#### Designation: FSC

Width	9.8 mm
Height	5.5 mm
Length	11.2 mm
Pitch c. min.	10.0 mm
Colors	Black (BK), white (WH), grey (GY), red (RD)

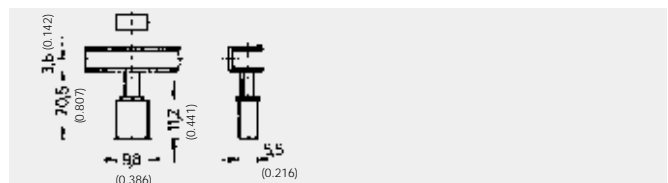

#### Designation: FSD, also for PVA

Width	12.3 mm
Height	7.0 mm
Length	10.5 mm
Pitch c. min. <sup>1)</sup>	12.5 mm/10.0 mm
Colors	Black (BK), white (WH), grey (GY), red (RD)

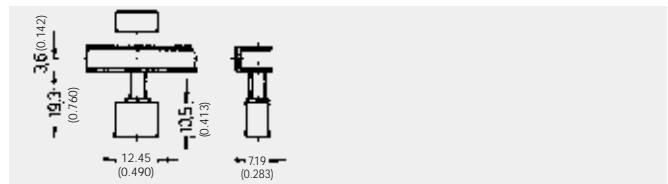

#### Designation: FU12

Width	12.4 mm
Height	5.7 mm
Length	11.05 mm
Pitch c. min. <sup>1)</sup>	12.5 mm
Colors	Black (BK), white (WH), grey (GY), red (RD)

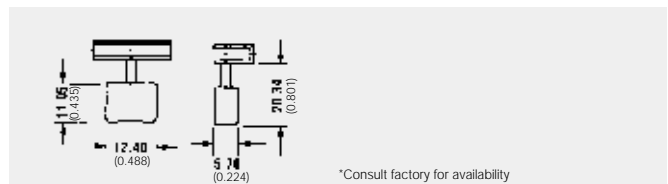
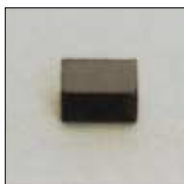

\*Consult factory for availability

# F-Buttons

## Non-illuminated Buttons for F Series, PVA, Mains/Power Switches NE18 and NE18CTII

### Designation: FSB, also for PVA

Width	14.7 mm
Height	7.4 mm
Length	11.0 mm
Pitch c. min. <sup>1)</sup>	15.0 mm/10.0 mm
Colors	Black (BK), white (WH), grey (GY), red (RD)

### Designation: FE

Width	17.3 mm
Height	6.0 mm
Length	12.0 mm
Pitch c. min. <sup>1)</sup>	17.5 mm/10.0 mm
Colors	Black (BK), white (WH), grey (GY), red (RD)

### Designation: FSA, also for PVA

Width	17.2 mm
Height	8.0 mm
Length	13.0 mm
Pitch c. min. <sup>1)</sup>	17.5 mm/10.0 mm
Body	Black (BK), white (WH), grey (GY)
Insert	Silver (SR)

### Designation: FA

Width	19.6 mm
Height	10.0 mm
Length	11.5 mm
Pitch c. min. <sup>1)</sup>	20.0 mm/12.5 mm
Colors	Black (BK), white (WH), grey (GY), red (RD)

<sup>1)</sup> Rectangular buttons can be mounted horizontally or vertically according to center to center spacing of buttons.

### Dimensional Drawings

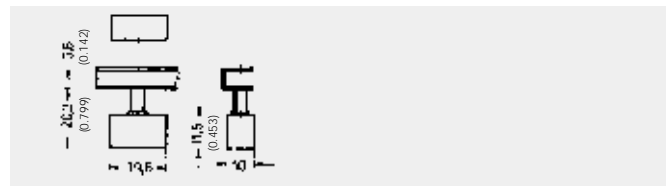
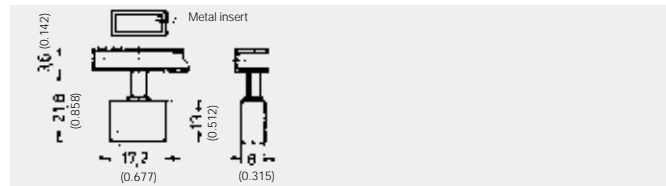
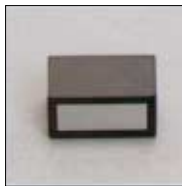
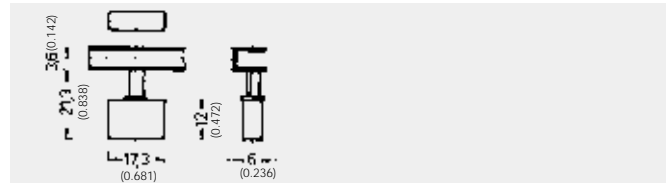
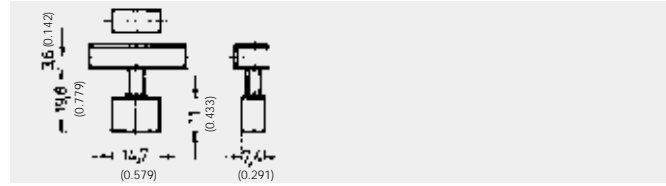

# F Indicating Buttons

## For F Series, Mains/Power Switches NE18 and NE18CTII

### Designation: FA100

Width	17.3 mm
Height	8.5 mm
Length	17.5 mm
Pitch c. min.	17.5 mm
Housing colors	Black (BK), white (WH), grey (GY)
Indicator "ON"	White (WH), orange (OG), yellow (YE), green (GN), blue (BU)
"OFF"	Housing colors

### Designation: FA101

Width	8.5 mm
Height	17.3 mm
Length	17.5 mm
Pitch c. min.	17.5 mm/10.0 mm
Housing colors	Black (BK), white (WH), grey (GY)
Indicator "ON"	White (WH), orange (OG), yellow (YE), green (GN), blue (BU)
"OFF"	Housing colors

### Designation: FA110

Width	17.2 mm
Height	17.2 mm
Length	22.0 mm
Pitch c. min.	17.5 mm
Housing colors	Black (BK), white (WH), grey (GY)
Indicator "ON"	Black (BK), white (WH), grey (GY)
"OFF"	Blue (BU), orange (OG), yellow (YE), green (GN)
"ON" and "OFF"	Colors can be combined differently

### Designation: FA120

Width	9.9 mm
Height	8.6 mm
Length	10.0 mm
Pitch c. min.	10.0 mm
Housing colors	Black (BK), grey (GY)
Indicator "ON"	White (WH), orange (OG), yellow (YE), green (GN), blue (BU)
"OFF"	Housing colors

### Designation: FA201

Diameter	10.0 mm
Height	11.0 mm
Pitch c. min.	12.5 mm
Housing colors	Black (BK), white (WH), grey (GY)
Indicator "ON"	White (WH), orange (OG), yellow (YE), green (GN), blue (BU)
"OFF"	Housing colors

### Dimensional Drawings

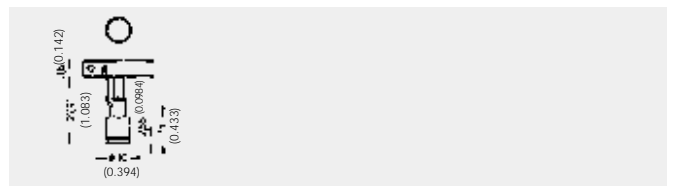
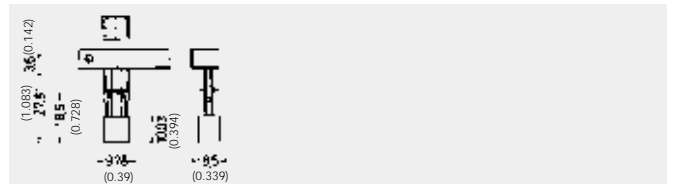
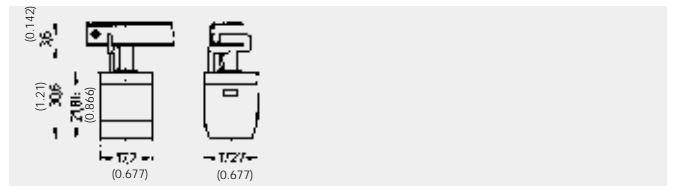
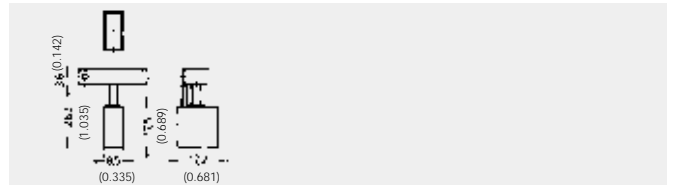
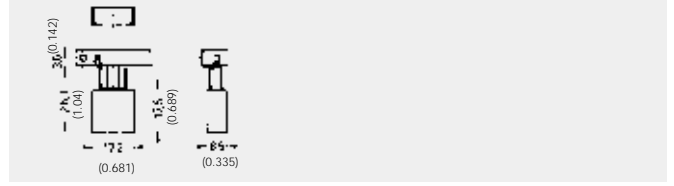

### Style and color availability - US orders only

Color	Shell						OUT position									IN position										
	Black	White	Light grey	Dark grey	Chrome	Gold	Black	White	Light grey	Dark grey	Yellow	Blue	Green	Gold	Orange	Amber	Black	White	Light grey	Dark grey	Yellow	Blue	Green	Gold	Orange	Amber
Color code	01	02	04	05	00	10	01	02	04	05	06	07	08	10	12	15	01	02	04	05	06	07	08	10	12	15
Style code																										
<b>F01</b>	X	X		X	X	X	X	X		X	X					X		X			X	X	X		X	X
<b>F02</b>	X	X		X	X	X	X	X		X	X					X		X			X	X	X		X	X
<b>F05</b>	X	X		X			X	X		X	X	X	X		X		X	X		X	X	X	X		X	
<b>F07</b>	X			X			X			X								X			X	X	X		X	
<b>F08/F11</b>	X	X		X	X		X	X		X							X				X	X	X	X	X	X

**Note:** Other colors available on special request. **Example: F05010112**  
 An FA110 style button with a black shell, black "OUT" indicator and orange "IN" indicator.



Dimensions are shown in mm (inch)  
 Dimensions subject to change

# F Illuminated Buttons

For F Series, Mains/Power Switches NE18 and NE18CTII

## Designation: FVR\*B (not for PVA)

Width	17.2 mm
Height	17.2 mm
Length	19.0 mm
Pitch c min.	17.5 mm
Body	Black (BK), white (WH), grey (GY)
Reflecting cap	Red (RD), orange (OG), green (GN), blue (BU), yellow (YE), colorless-clear (CL)

## Designation: FSR\*

Width	17.4 mm
Height	17.4 mm
Length	21.0 mm
Pitch c min.	17.5 mm
Body	Black (BK), white (WH), grey (GY)
Reflecting cap	Red (RD), orange (OG), green (GN), blue (BU), yellow (YE), colorless-clear (CL)

\* Illuminated buttons with grey or black housing require an additional reflector to improve luminous efficiency.

## Dimensional Drawings

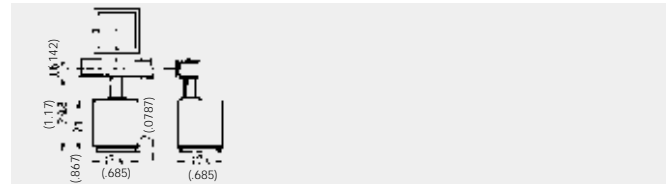
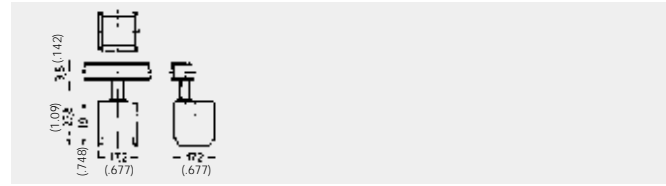

## Button order code

Color	Shell				Lens							
	Black	White	Light grey	Grey	Red	Yellow	Blue	Green	Orange	Clear/White	Smoke	
Color code	01	02	04	05	03	06	07	08	12	16	18	
<b>Style code</b>												
<b>F21*</b>	X	X		X	X	X	X	X	X	X		
<b>F22*</b>	X	X		X	X	X	X	X	X	X	X	

\* Available also with front panel bezel.

## Example: F210103

An FRV style button with a black shell and a red lens.

## Lampholders

<b>Type FL1</b>	Standard version. No electrical connection to module. Lamps are illuminated by applying voltage to the solder lugs of the lampholder contacts.
<b>Type FL2</b>	For use only on modules with solder lugs on top face. One of the lampholder contacts is electrically linked with the module by means of a blade spring connecting the normally closed contact of the left side front changeover.
<b>Type FL3</b>	For use only on modules with solder lugs on top face. Both of the lampholder contacts are electrically linked with the module's normally closed contacts.

## Choice of Lamps - US

Alba Lamp			
V/mA		6/30	12/30
Recommended undervoltage		5 V	10 V
Current at undervoltage		25 mA	25 mA

## Choice of Lamps - Europe

Alba Lamp	A-810-3K	A-812-3K	A-814-3K	A-824-3K
V/mA	5/60	6/40	12/40	24/20
Recommended undervoltage	4.5 V	5 V	10 V	20 V
Current at undervoltage	57 mA	31 mA	31 mA	18 mA

The illuminated option can be used with the basic F series switches including the power switches. By the addition of a lampholder, lamp, and lens a versatile illuminated switch is obtained. Three methods of termination are available (see above).

The F series illuminated option is also available in multiple assemblies with a minimum spacing centerline of 17.5 mm (.689 inch).

In backlight push-buttons the heat of the lamps has to be considered. With intermittent or continuous operation up to 0.6 W, it is quite easy to dissipate heat. With higher rating or simultaneously burning lamps, especially in connection with the heat created by the equipment itself, it is necessary to provide efficient venting holes or air circulation.

**Note:** Power switches must have auxiliary low power contacts for illumination.

Example: NE18 2U 2A (2U = auxiliary contacts)