

# E5□J Temperature Controller

## Operation Manual

Cat. No. Z103-E3-1

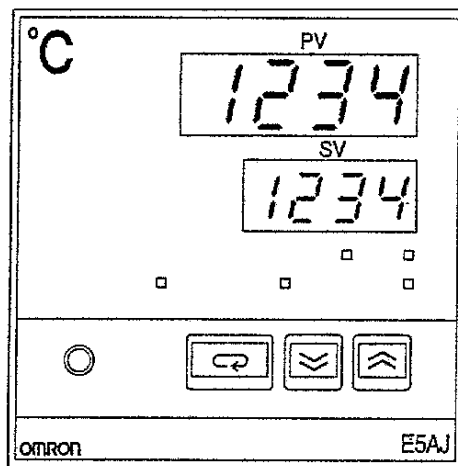



## Notice:

OMRON products are manufactured for use according to proper procedures by a qualified operator and only for the purposes described in this manual.

The following conventions are used to indicate and classify precautions in this manual. Always heed the information provided with them. Failure to heed precautions can result in injury to people or damage to the product.

 **DANGER** Indicates information that, if not heeded, is likely to result in loss of life or serious injury.

 **WARNING** Indicates information that, if not heeded, could possibly result in loss of life or serious injury.

 **Caution** Indicates information that, if not heeded, could result in relatively serious or minor injury, damage to the product, or faulty operation.

## OMRON Product References

All OMRON products are capitalized in this manual. The word “Unit” is also capitalized when it refers to an OMRON product, regardless of whether or not it appears in the proper name of the product.

The abbreviation “Ch,” which appears in some displays and on some OMRON products, often means “word” and is abbreviated “Wd” in documentation in this sense.

The abbreviation “PC” means Programmable Controller and is not used as an abbreviation for anything else.

## Visual Aids

The following headings appear in the left column of the manual to help you locate different types of information.

**Note** Indicates information of particular interest for efficient and convenient operation of the product.

**1, 2, 3...** 1. Indicates lists of one sort or another, such as procedures, checklists, etc.

## © OMRON, 1998

All rights reserved. No part of this publication may be reproduced, stored in a retrieval system, or transmitted, in any form, or by any means, mechanical, electronic, photocopying, recording, or otherwise, without the prior written permission of OMRON.

No patent liability is assumed with respect to the use of the information contained herein. Moreover, because OMRON is constantly striving to improve its high-quality products, the information contained in this manual is subject to change without notice. Every precaution has been taken in the preparation of this manual. Nevertheless, OMRON assumes no responsibility for errors or omissions. Neither is any liability assumed for damages resulting from the use of the information contained in this publication.

# TABLE OF CONTENTS

<b>SECTION 1</b>	
<b>Introduction</b> .....	<b>1</b>
1-1 Features .....	2
1-2 Models .....	2
1-3 Specifications .....	4
<b>SECTION 2</b>	
<b>Sensor and Mode Settings</b> .....	<b>9</b>
2-1 Disassembly .....	10
2-2 Output Units .....	10
2-3 Internal Switch Settings .....	11
<b>SECTION 3</b>	
<b>Settings Before Operation</b> .....	<b>17</b>
3-1 Nomenclature .....	18
3-2 Setting Flowchart .....	19
3-3 List of Parameters .....	20
3-4 Parameters on Display Level 0 .....	22
3-5 Parameters on Display Level 1 .....	23
<b>SECTION 4</b>	
<b>Fuzzy Self-tuning</b> .....	<b>27</b>
4-1 Fuzzy Self-tuning Operation .....	28
4-2 Troubleshooting .....	31
4-3 Terminology .....	32
<b>SECTION 5</b>	
<b>Installation and Wiring</b> .....	<b>35</b>
5-1 Installation .....	36
5-2 Wiring .....	37
5-3 Terminal Arrangement .....	38
<b>SECTION 6</b>	
<b>Troubleshooting</b> .....	<b>41</b>
6-1 Error Display and Output .....	42
6-2 Troubleshooting .....	42
<b>SECTION 7</b>	
<b>Event Input Function</b> .....	<b>45</b>
7-1 Event Input Function .....	46
<b>SECTION 8</b>	
<b>Heater Burnout Detection</b> .....	<b>49</b>
8-1 Heater Burnout Detection .....	50
8-2 Heater Burnout Procedures .....	50
8-3 Wiring the Current Transformer .....	51
8-4 Heater Burnout Alarm Value .....	51
<b>SECTION 9</b>	
<b>Engineering Level Settings</b> .....	<b>55</b>
9-1 Engineering Level .....	56
9-2 Engineering Level Parameter List .....	56
9-3 Engineering Level Parameters .....	58

# TABLE OF CONTENTS

<b>SECTION 10</b>	
<b>Auto-tuning</b> .....	<b>63</b>
10-1 Starting Auto-tuning .....	64
10-2 Conditions that Prevent Auto-tuning .....	64
10-3 Force-ending Auto-tuning .....	64
10-4 Changing Parameters during Auto-tuning .....	64
<b>Appendices</b>	
A Dimensions/Mounting Holes .....	65
<b>Index</b> .....	<b>69</b>
<b>Revision History</b> .....	<b>71</b>

## About this Manual:

This manual describes the installation and operation of the Thermac E5□J Temperature Controller and includes the sections described below.

Please read this manual carefully and be sure you understand the information provided before attempting to install and operate the Thermac E5□J Temperature Controller.

**Section 1** describes the specifications and basic features of the Thermac E5□J Temperature Controller.

**Section 2** describes the sensor and mode settings of the Thermac E5□J Temperature Controller that are necessary before turning on the Thermac E5□J Temperature Controller.

**Section 3** describes the settings of the Thermac E5□J Temperature Controller that are necessary before operating the Thermac E5□J Temperature Controller.

**Section 4** provides the procedures required to adjust all PID constants using fuzzy self-tuning according to the characteristics of the device for ideal temperature control.

**Section 5** describes the installation and wiring of the Thermac E5□J Temperature Controller.

**Section 6** describes the troubleshooting of the Thermac E5□J Temperature Controller.

**Section 7** describes how the event input function of the Thermac E5□J Temperature Controller works.

**Section 8** describes the basic features of heater burnout detection and necessary steps that should be taken at the time of heater burnout, as well as the method of obtaining heater burnout alarm values.

**Section 9** describes the parameters that can be changed on the engineering level. These parameters should be changed only when the values set before shipping do not suit the application. After these parameters are changed on the engineering level, record the contents of the changes for your future reference.

**Section 10** describes how to execute auto-tuning.

The **Appendix** provides the dimensions and mounting specifications for the various Thermac E5□J Temperature Controller Units.

**WARNING**

Failure to read and understand the information provided in this manual may result in personal injury or death, damage to the product, or product failure. Please read each section in its entirety and be sure you understand the information provided in the section and related sections before attempting any of the procedures or operations given.

# SECTION 1

## Introduction

This section describes the specifications and basic features of the Thermanc E5□J Temperature Controller.

- 1-1 Features ..... 2
- 1-2 Models ..... 2
- 1-3 Specifications ..... 4
  - 1-3-1 Ratings ..... 4
  - 1-3-2 Characteristics ..... 6

# 1-1 Features

The basic features of the Thermac E5□J Temperature Controller are outlined below.

## Fuzzy Self-tuning

When using a conventional temperature controller for ideal temperature control, it is necessary to adjust the PID constants of the temperature controller according to the controlled device. The Thermac E5□J Temperature Controller incorporates a fuzzy self-tuning function, thus allowing ideal temperature control without any adjustment of the PID constants. The user needs only to set the E5□J to the desired temperature for ideal temperature control.

## Auto-tuning

Auto-tuning is also available. It is useful when appropriate results are not obtained through fuzzy self-tuning. (Refer to *Section 10 Auto-tuning.*)

## Event Input Function

It is possible to select a set point out of a maximum of two set values on the E5CJ-□B and four set values on the E5AJ-□B via their event input terminals from the PCs connected to these Temperature Controllers. The control operation of the E5AJ-□B via can be stopped with an event input signal.

## Watertight Construction

The E5□J can be used in places where water is sprayed onto the E5□J, because the front panel of the E5□J assures IP54 when the E5□J is panel-mounted (except for front panel of the E5CJ, which assures IP50). If greater watertightness is required, use the Y92A-□□N, a dedicated watertight cover (sold separately).

## Advanced PID

The E5□J incorporates an advanced PID function, which is also incorporated by the Thermac X Temperature Controller. The advanced PID function prevents temperature overshooting the moment the Temperature Controller starts operating, assures a short startup time, and performs ideal temperature control by quickly responding to external disturbances.

## Output Units

The E53-R Relay Unit, E53-Q, E53-Q3, and E53-Q4 Voltage Output Units for driving SSRs, and E53-C3, E53-C3D, E53-V34, and E53-V35 Linear Output Unit can be connected to any E5□J Temperature Controller (except the E5CJ) with ease according to the desired output configuration and application.

# 1-2 Models

The thermocouples and platinum resistance thermometers listed in the following table can be connected to any Thermac E5□J Temperature Controller.

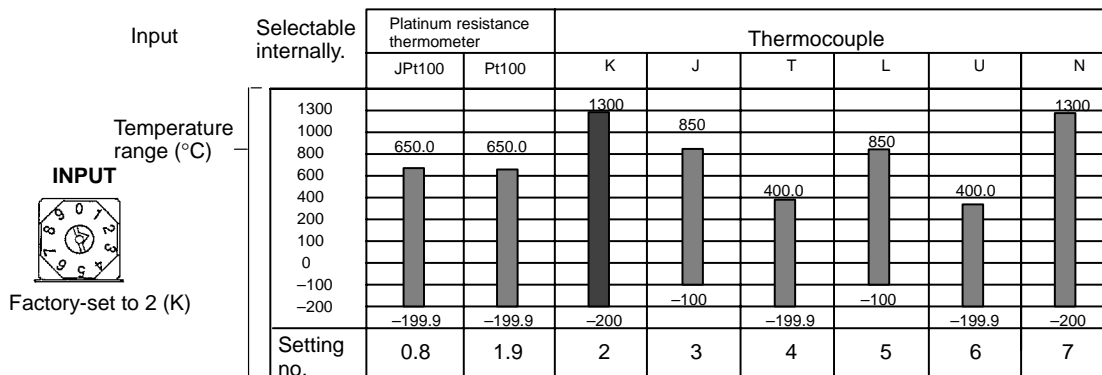

**E5AJ (Standard Model with Communications Function)**

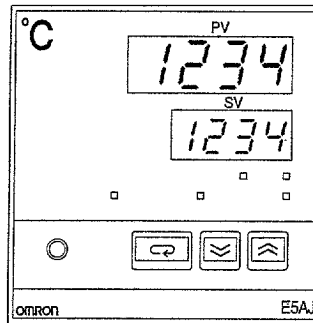

96 X 96mm

Alarm		2 relay output points with heater burnout alarm (see note 1)	
Event input		2 points (set point selection, RUN/STOP) (see note 2)	
Control output		Replaceable Output Unit (sold separately)	
Model	Communications function	---	E5AJ-A2HB
		RS-232C	E5AJ-A2H01
		RS-422	E5AJ-A2H02
		RS-485	E5AJ-A2H03
	Communications Board add-on model	E5AJ-A2HM	

- Note**
1. No heater burnout alarm is output if the E53-C3 Current Output Unit is used with the E5AJ.
  2. The event input function is not incorporated by models that have a communications function.

**E5EJ (Standard Model with Communications Function)**

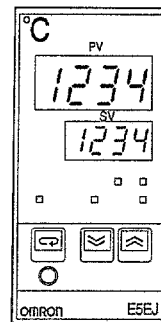

48 X 96mm

Alarm		2 relay output points with heater burnout alarm (see note 1)	
Event input		2 points (set point selection, RUN/STOP) (see note 2)	
Control output		Replaceable Output Unit (sold separately)	
Model	Communications function	---	E5EJ-A2HB
		RS-232C	E5EJ-A2H01
		RS-422	E5EJ-A2H02
		RS-485	E5EJ-A2H03
	Communications Board add-on model	E5EJ-A2HM	

- Note**
1. No heater burnout alarm is output if the Linear Output Unit is used with the E5EJ.
  2. The event input function is not incorporated by models that have a communications function.



E5CJ (Simple and Standard Models)

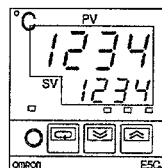

48 X 48mm

Type	Simple model type		Standard model type		
Alarm	---		2 relay output points with the same common. (see note 1)		
Heater burnout alarm	---		Yes (see note)		
Event input	---		1 point (set point selection)		
Model	Control output	Relay output	E5CJ-R	E5CJ-R2	E5CJ-R2HB
		Voltage output	E5CJ-Q	E5CJ-Q2	E5CJ-Q2HB
		Current output	E5CJ-C	E5CJ-C2	E5CJ-C2B

**Note** No heater burnout alarm is output if a current control output is used.

Communications Boards

Communications	RS-232C	RS-422	RS-485
Model	E53-J01	E53-J02	E53-J03

**Note** For details, refer to the *E5AJ/E5EJ Communications Manual (Z102)*.

## 1-3 Specifications

### 1-3-1 Ratings

E5□J

Item		Specification	
Supply voltage		100 to 240 VAC, 50 or 60 Hz	24 V AC/DC, 50 or 60 Hz
Operating voltage range		85 to 110% of supply voltage	
Power consumption	E5AJ	10 VA (at 100 VAC) to 14 VA (at 240 VAC)	10 VA (at 24 VAC) 6 W (at 24 VDC)
	E5EJ	10 VA (at 100 VAC) to 14 VA (at 240 VAC)	
	E5CJ	10 VA (at 100 VAC) to 12 VA (at 240 VAC)	
Input		Thermocouples (K, J, T, L, U, and N) and platinum resistance thermometers (JPt100 and Pt100)	
CT input		Dedicated CT (E54-CT1 or E54-CT3)	
Control output	E5AJ/E5EJ		Replaceable Output Unit (sold separately)
	E5CJ	Relay output	SPST-NO, 3 A at 250 VAC (resistive load)
		Voltage output	20 mA at 12 VDC (with short-circuit protection)
Current output		4 to 20 mA DC with a load of 600 Ω max. and a resolution of approx. 2600	
Control mode		ON/OFF or advanced PID with fuzzy self-tuning and auto-tuning	
Alarm output	E5AJ/E5EJ		2 SPST-NO relay output points, 3 A at 250 VAC (resistive load)
	E5CJ		2 SPST-NO relay output points (with the same common), 1 A at 250 VAC (resistive load)
Setting method		Digital setting with Up Key and Down Key	

Item		Specification
Indication method	E5AJ	All digital indication (PV: Red, 15 mm; SV: Green, 10.5 mm)
	E5EJ	All digital indication (PV: Red, 14 mm; SV: Green, 9.5 mm)
	E5CJ	All digital indication (PV: Red, 12 mm, SV: Green 8.0 mm)
Event input		Contact input: ON: 1 kΩ max. OFF: 100 kΩ min. No-contact input: ON: residual voltage of 3 V max; OFF: current leakage of 1 mA max.
Other function		<ul style="list-style-type: none"> <li>• Key protect</li> <li>• Cooling operation/Heating operation</li> <li>• Heater burnout alarm</li> </ul> Model with event input (E5□J-□B) <ul style="list-style-type: none"> <li>• Set point selection (set point x 2)</li> <li>• RUN/STOP (E5AJ-□B and E5EJ-□B only)</li> </ul>
Ambient operating temperature		-10°C to 55°C (with no condensation)
Ambient operating humidity		35 to 85%
Storage temperature		-25°C to 65°C (with no condensation)

**Output Units**

Model	Specification
E53-R Relay Output Unit	SPDT (SPST-NO when used with the E5□J), 5 A at 250 VAC (resistive load)
E53-Q Voltage Output Unit	NPN, 40 mA at 12 VDC (with short-circuit protection)
E53-Q3 Voltage Output Unit	NPN, 20 mA at 24 VDC (with short-circuit protection)
E53-Q4 Voltage Output Unit	PNP, 20 mA at 24 VDC (with short-circuit protection)
E53-C3 Linear Output Unit	4 to 20 mA DC with a load of 600 Ω max. (with a resolution of approximately 2600 when used with the E5□J) (see note)
E53-C3D Linear Output Unit	0 to 20 mA DC with a load of 600 Ω max. (with a resolution of approximately 2600 when used with the E5□J)
E53-V34 Linear Output Unit	0 to 10 VDC with a load of 1 kΩ min. (with a resolution of approximately 2600 when used with the E5□J)
E53-V35 Linear Output Unit	0 to 5 VDC with a load of 1 kΩ min. (with a resolution of approximately 2600 when used with the E5□J)

**Note** The E53-C cannot be used.

**Current Transformer (CT)**

Item	Specification
Maximum continuous heater current	50 A
Dielectric strength	1,000 VAC
Vibration resistance	50 Hz, approx. 98 m/s <sup>2</sup> (10G)
Weight	E54-CT1: Approx. 11.5 g E54-CT3: Approx. 50 g

## 1-3-2 Characteristics

## E5□J

Item		Specification
Indication accuracy		±0.5% or ±1°C whichever is larger ± 1 digit max. Thermocouple K, T, or N at a temperature of –100°C; thermocouple U at ± 2°C ± 1 digit max.
Hysteresis (for ON/OFF control)		0.1 to 999.9°C/°F (in units of 0.1°C/°F)
Proportional band		0.1 to 999.9°C/°F (in units of 0.1°C/°F)
Integral time		0 to 3999 s (in units of 1 s)
Derivative time		0 to 3999 s (in units of 1 s)
Control period		Relay or voltage output: 1 to 99 s (in units of 1 s)
Manual reset value (I = 0)		0.0 to 100.0% (in units of 0.1%)
Alarm setting range		With K, J, L, or N input: –1999 to 9999° C/°F (in units of 1°C/°F) With JPt100, Pt100, T, or U input: –199.9 to 999.9° C/°F (in units of 0.1°C/°F)
Sampling period		500 ms
Output refresh period		500 ms
Display refresh period		500 ms
Insulation resistance		20 MΩ min. at 500 VDC (measured with an Output Unit)
Dielectric strength		2000 VAC, 50/60 Hz for 1 min. between charged terminals different from each other in polarity
Vibration resistance	Malfunction	10 to 55 Hz, 9.8 m/s <sup>2</sup> (1G) 10 min. in X, Y, and Z directions
	Destruction	10 to 55 Hz, 19.6 m/s <sup>2</sup> (2G) 2 hr. in X, Y, and Z directions
Shock resistance	Malfunction	196 m/s <sup>2</sup> (20G) 3 times each in 3-axis 6 directions (98 m/s <sup>2</sup> (10G) for the relay)
	Destruction	294 m/s <sup>2</sup> (30G) 3 times each in 3-axis 6 directions
Weight	E5AJ	Approx. 360 g; mounting bracket: approx. 65 g
	E5EJ	Approx. 280 g; mounting bracket: approx. 65 g
	E5CJ	Approx. 170 g; adapter: approx. 10 g
Enclosure rating		Front panel: E5AJ/E5EJ: IEC standard IP54 E5CJ: IEC standard IP50 (see note 1) Rear case: IEC standard IP20 Terminals: IEC standard IP00
Memory Protection		Non-volatile memory
EMC		Emission Enclosure: EN55011 Group 1 class A Emission AC Mains: EN55011 Group 1 class A Immunity ESD: EN61000-4-2: 4 kV contact discharge (level 2) 8 kV air discharge (level 3) Immunity RF-interference: ENV50140: 10 V/m (amplitude modulated, 80 MHz to 1 GHz) (level 3) 10 V/m (pulse modulated, 900 MHz) Immunity Conducted Disturbance: ENV50141: 10 V (0.15 to 80 MHz) (level 3) Immunity Burst: EN61000-4-4: 2 kV power-line (level 3) 2 kV I/O signal-line (level 4)
Approved standards		UL1092, CSA C22.2 No. 142 Conforms to EN50081-2, EN50082-2, EN61010-1 (IEC1010-1) (see note 2) Conforms to VDE0106/part 100 (Finger Protection), when the separately-ordered terminal cover is mounted.

- Note**
1. The model numbers of the exclusive watertight covers conforming to IP66, NEMA4 are as follows:  
For E5AJ: Y92A-96N; For E5CJ: Y92A-48N; For E5EJ: Y92A-49N
  2. Basic insulation is between the input and output.

**Output Unit**

Model	Life expectancy	
E53-R Relay Output Unit	Mechanical	10,000,000 times min.
	Electrical	100,000 times min.

**Heater Burnout Alarm**

Item	Specification
Max. heater current	Single-phase 50 A VAC (see note 1)
Heater current value display accuracy	±5% FS ± 1 digit max.
Heater burnout alarm setting range	0.1 to 49.9 A (in units of 0.1 A) (see note 2)
Min. detection ON time	190 ms (see note 3)

- Note**
1. Use the K2CU-F□□A-□GS (with gate input terminals) for the detection of three-phase heater burnout.
  2. The heater burnout alarm is always OFF if the alarm is set to 0.0 A and always ON if the alarm is set to 50.0 A.
  3. No heater burnout detection or heater current value measurement is possible if the control output is ON for less than 190 ms.

**Model with Communications Function**

Refer to the *E5AJ/E5EJ Communications Manual (Z102)* for details.

Item		Specification
Interface		RS-232C, RS-422, RS-485
Communications method		Half duplex
Synchronization method		Start-stop synchronization (non-synchronization)
Communications speed		1200, 2400, 4800, 9600, and 19200 bps
Communications item	Writing to Thermac J	Set point, alarm value, heater burnout alarm value, proportional band, derivative time, integral time, and input shift value
	Reading from Thermac J	Process value, set point, alarm value, heater burnout alarm value, heater current value, proportional band, derivative time, integral time, output value, input shift and error code

## SECTION 2

# Sensor and Mode Settings

This section describes the sensor and mode settings of the Thermac E5□J Temperature Controller that are necessary before turning on the Thermac E5□J Temperature Controller.

2-1	Disassembly .....	10
2-2	Output Units .....	10
2-3	Internal Switch Settings .....	11
2-3-1	Internal Switch Positions .....	11
2-3-2	Input Type Selector Setting .....	12
2-3-3	Alarm Mode Setting .....	13
2-3-4	Standby Sequence .....	14
2-3-5	Function Selector Settings .....	14
2-3-6	Key Protection Switch Settings .....	15

## 2-1 Disassembly

Before turning on the E5□J, set its sensor type and control mode with the internal selectors. Refer to the following illustrations for disassembling the E5□J to access the internal switch settings.

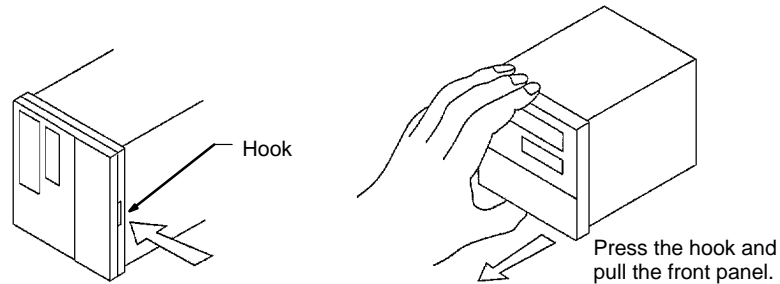

After setting the internal switches, insert the internal mechanism into the case until the front panel snaps with the hook.

## 2-2 Output Units

Select the Output Unit according to the application and mount the Output Unit into the socket on the E5□J PCB of the as shown in the following illustration. The E5CJ does not require an Output Unit. Refer to *1-3 Specifications* for the output ratings of the E5□J.

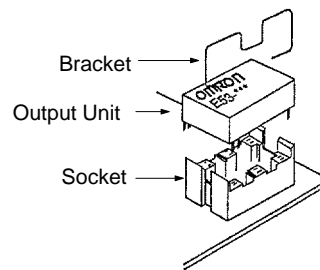

### Output Units

The following Output Units are available.

Model	Rating
E53-R Relay Output Unit	SPDT, 5 A at 250 VAC (resistive load)
E53-Q Voltage Output Unit	NPN model, 40 mA at 12 VDC (with short-circuit protecting circuit)
E53-Q3 Voltage Output Unit	NPN model, 20 mA at 24 VDC (with short-circuit protecting circuit)
E53-Q4 Voltage Output Unit	PNP model, 20 mA at 24 VDC (with short-circuit protecting circuit)
E53-C3 Linear Output Unit	4 to 20 mA DC with a load of 600 $\Omega$ max.
E53-C3D Linear Output Unit	0 to 20 mA DC with a load of 600 $\Omega$ max.
E53-V34 Linear Output Unit	0 to 10 VDC with a load of 1 k $\Omega$ min.
E53-V35 Linear Output Unit	0 to 5 VDC with a load of 1 k $\Omega$ min.

After mounting the Output Unit, be sure to secure it with the mounting bracket provided with the Output Unit.

If the E53-C3, E53-C3D, E53-V34, and E53-V35 Linear Output Unit is used for control output, no heater burnout alarm is available.

Each Voltage Output Unit is used for driving an SSR as shown in the following illustrations.

NPN Model: E53-Q (40 mA at 12 VDC) and E53-Q3 (20 mA at 24 VDC)

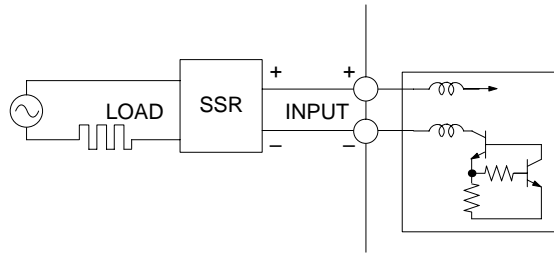

PNP Model: E53-Q4 (20 mA at 24 VDC)

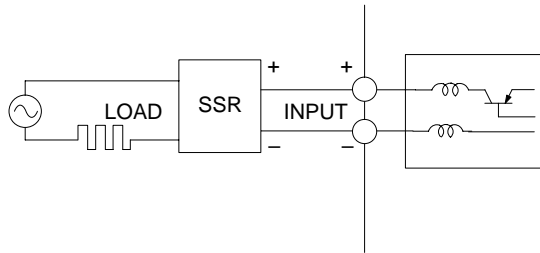

## 2-3 Internal Switch Settings

### 2-3-1 Internal Switch Positions

E5AJ

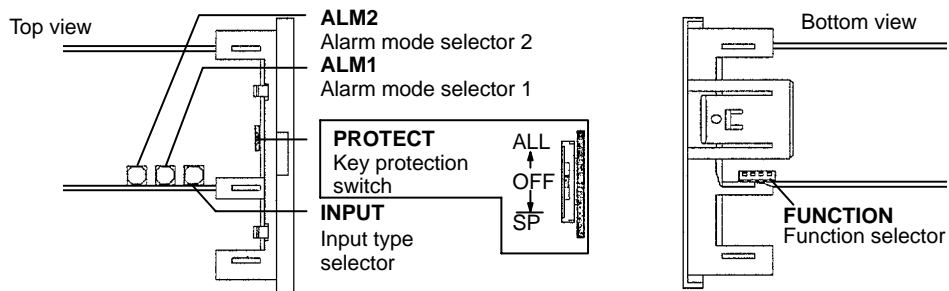

E5EJ

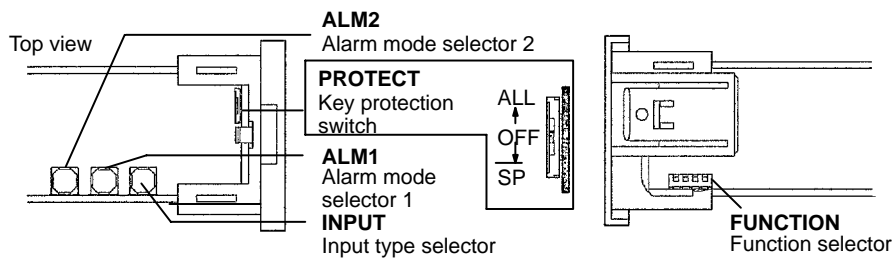

E5CJ

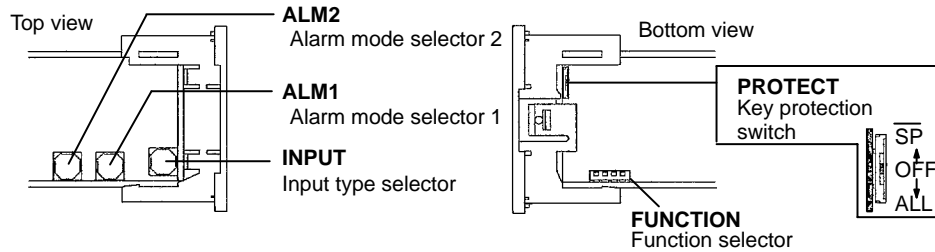

**Note** The E5CJ with no alarm does not incorporate ALM1 or ALM2.

### 2-3-2 Input Type Selector Setting

The input type selector is factory-set to 2 (K). Refer to the following table for the selection of the desired sensor.



Selector no.	Input	Set temperature range		Specified temperature range	
		°C	°F	°C	°F
0, 8	JPt100	-199.9 to 650.0	-199.9 to 999.9	-199.9 to 735.0	-199.9 to 999.9
1, 9	Pt100	-199.9 to 650.0	-199.9 to 999.9	-199.9 to 735.0	-199.9 to 999.9
2	K	-200 to 1300	-300 to 2300	-350 to 1450	-560 to 2560
3	J	-100 to 850	-100 to 1500	-195 to 945	-260 to 1660
4	T	-199.9 to 400.0	-199.9 to 700.0	-199.9 to 460.0	-199.9 to 790.0
5	L	-100 to 850	-100 to 1500	-195 to 945	-260 to 1660
6	U	-199.9 to 400.0	-199.9 to 700.0	-199.9 to 460.0	-199.9 to 790.0
7	N	-200 to 1300	-300 to 2300	-350 to 1450	-560 to 2560

**Note** The resistance of the JPt100 at a temperature of 100°C is 139.16 Ω and that of the Pt100 at a temperature of 100°C is 138.50 Ω.

- 1, 2, 3...**
1. To use Fahrenheit, set function selector 4 to ON, which is usually set to OFF.
  2. Insert the internal mechanism into the case.
  3. Turn on the E5□J so that d-u will be displayed on the process value display. Then press the Up Key so that f will be displayed on the set value display.
  4. Turn off the power in two seconds.
  5. Draw the internal mechanism from the case and set function selector 4 to OFF and turn on the E5□J.



### 2-3-3 Alarm Mode Setting

ALM1 and ALM2 are both factory-set to 2 (upper limit alarm). Refer to the following table for the selection of the desired alarm mode.

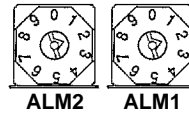

Selector no.	Alarm mode	Alarm output		Setting range
		Positive alarm set value	Negative alarm set value	
0	No alarm function	OFF		---
1	Upper and lower limit alarm (deviation)		Always ON	-1999 to 9999 or -199.9 to 999.9 (the decimal position varies with the input type)
2	Upper limit alarm (deviation)			
3	Lower limit alarm (deviation)			
4	Upper and lower limit range alarm (deviation)	Always OFF		
5	Upper and lower limit alarm with standby sequence (deviation)	Always OFF		
6	Upper limit alarm with standby sequence (deviation)			
7	Lower limit alarm with standby sequence (deviation)			
8	Absolute value upper limit alarm			
9	Absolute value lower limit alarm			

If the alarm mode switch is set to 1 to 7, the alarm value is set with the deviation width from the set point as shown in the following diagram.

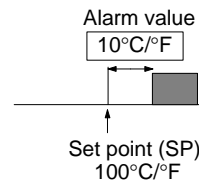

If the alarm mode switch is set to 8 or 9, the alarm value is set with the absolute value from 0°C/°F as shown in the following diagram.

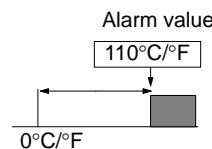

### 2-3-4 Standby Sequence

The alarm output is ON the moment the E5□J is turned on because the process value is within the alarm range. To prevent this, select a mode with a standby sequence. If a mode with a await sequence is selected, the alarm output will not be ON even if the process value is within the alarm range unless the process value once goes out of the alarm range. The following diagram shows the operation of the E5□J in lower limit alarm mode with a standby sequence.

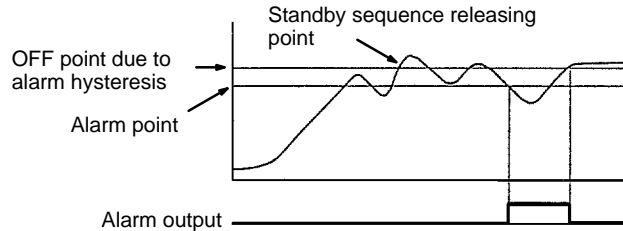

It is possible to change the alarm hysteresis (set to 0.2°C before shipping) on the engineering level.

### 2-3-5 Function Selector Settings

All the function selector pins are factory-set to OFF.

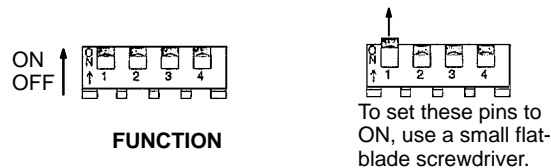

Refer to the following table for function switch setting.

		Pin no.	1	2	3	4
Output operation	Cooling operation (Normal)		ON	---	---	---
	Heating operation (Reverse)		OFF			
Control mode	ON/OFF control		---	ON	See note	
	Advanced PID		---	OFF	ON	
	Advanced PID with fuzzy self-tuning		---	OFF	OFF	
Level	Engineering level		---	---	---	ON
	Normal operation		---	---	---	OFF

**Note** The E5□J will be in ON/OFF control mode regardless of the setting of pin 3 if pin 2 is set to ON.

#### Output Operation (Pin 1)

##### Heating Operation

If pin 1 of the E5□J is set to OFF, when the process temperature is lower than the set point, the E5□J will operate so that the heater output will increase.

##### Cooling Operation

If pin 1 of the E5□J is set to ON, when the process temperature is higher than the set point, the E5□J will operate so that the output of cooling water will increase.

#### Control Mode (Pins 2 and 3)

##### ON/OFF Control

The ON/OFF control is also called two-position operation.

##### Advanced PID

Set the E5□J in this mode for P, PI, or PD control or if the most suitable PID constants for the controlled device are already known.

##### Advanced PID with Fuzzy Self-tuning

Set the E5□J in this mode so that Fuzzy self-tuning adjusts the PID constants to the most suitable values according to the controlled device for ideal temperature control. Refer to *Section 4 Fuzzy Self-tuning* for details.

#### Level (Pin 4)

Set pin 4 to ON if it is necessary to change any parameter on the engineering level. Set this pin to OFF for normal operation.

## 2-3-6 Key Protection Switch Settings

The key protection switch is used to prohibit parameter changes as shown in the following table. The key protection switch is factory-set to OFF.

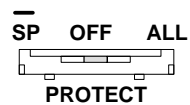

Mode	Protection
$\overline{\text{SP}}$	Prohibits all set value changes except the set point. The Level Key is not available. The Down Key and Up Key are available only for set point setting.
OFF	All keys are available.
ALL	Prohibits all set value changes. The Level Key, Down Key, and Up Key are not available.

# SECTION 3

## Settings Before Operation

This section describes the settings of the Thermac E5□J Temperature Controller that are necessary before operating the Thermac E5□J Temperature Controller.

3-1	Nomenclature .....	18
3-2	Setting Flowchart .....	19
3-3	List of Parameters .....	20
3-4	Parameters on Display Level 0 .....	22
3-5	Parameters on Display Level 1 .....	23

### 3-1 Nomenclature

The following is the front panel of the E5AJ-A2HB. The front panels of the E5EJ and E5CJ are similar to the front panel of the E5AJ-A2HB.

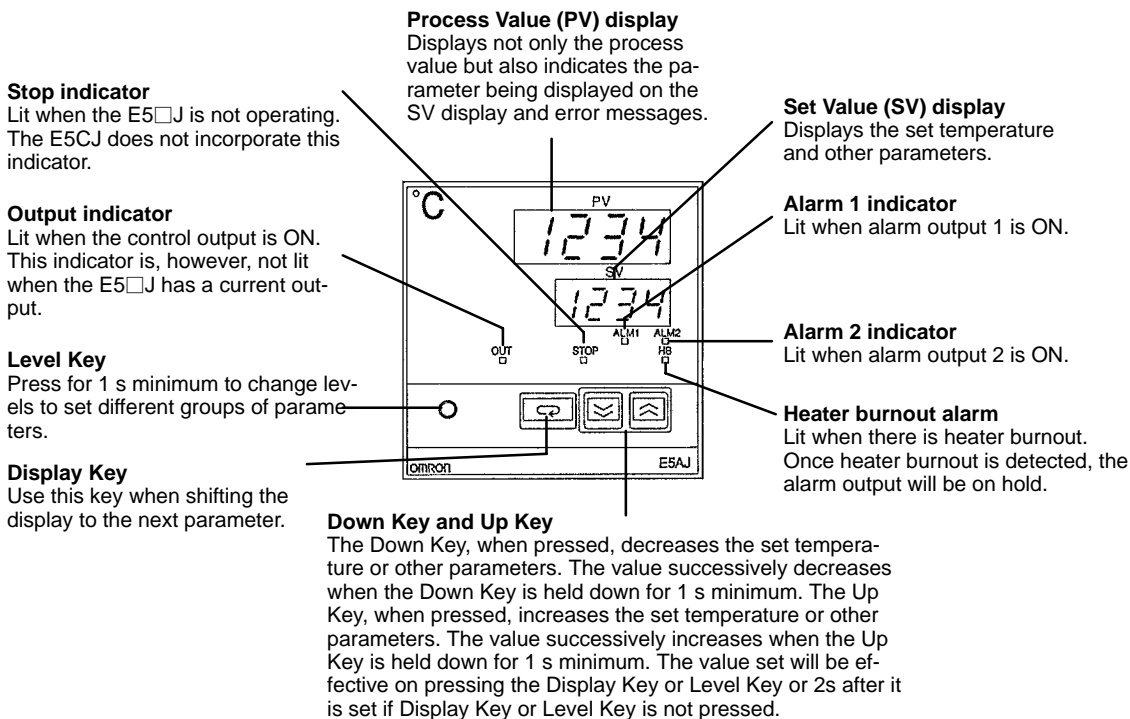

**Note** Refer to the *E5AJ/E5EJ Communications Manual* for the operation of E5□J models incorporating a communications function.

### 3-2 Setting Flowchart

The Thermac E5□J Temperature Controller starts control at the set point and continues controlling even while set values are being input for each display level. Therefore, when operating the E5□J after inputting all the set values, turn the power supply to the Temperature Controller off and then on again.

All parameters for the E5□J Temperature Controller are divided into three levels according to how frequently they are used.

**Display Level 0**

Parameters that are changed frequently are ranked as display level 0 parameters.

**Display level 1**

Parameters that are not changed frequently are ranked as display level 1 parameters.

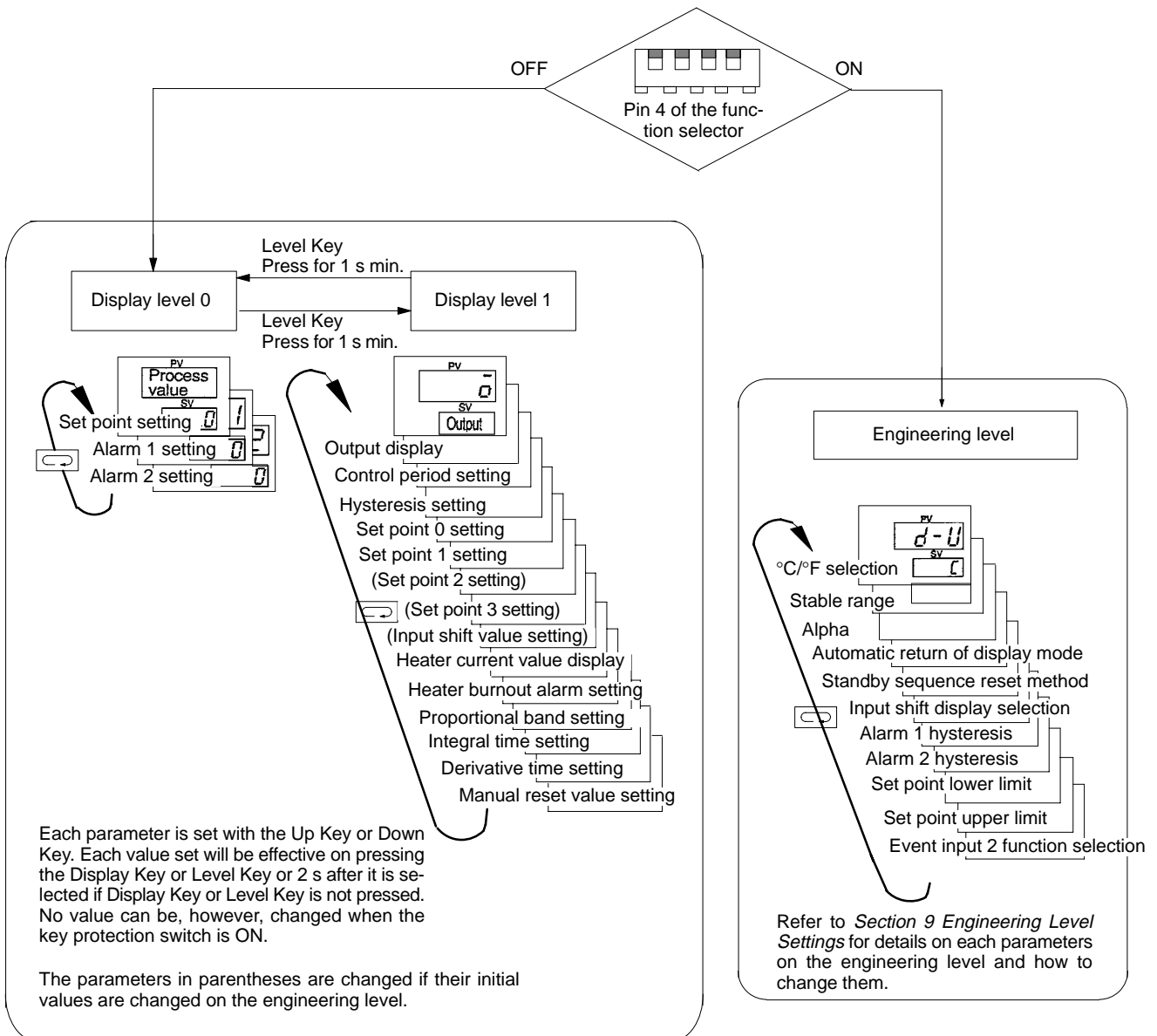

**Engineering Level**

Parameters that are changed with only a few applications are ranked as engineering level parameters.



### 3-3 List of Parameters









#### Display Level 0







Display	Name	Setting range	Setting before shipping	Remarks	
	---	Process value display and set point setting	Set point lower limit to set point upper limit (°C/°F)	0	The present set point is displayed and can be changed if the E5□J incorporates an event input function
	AL-1	Alarm set value 1	-1999 to 9999 °C/°F The decimal position varies with the kind of input.	0	Not displayed if alarm mode switch 1 is set to 0.
	AL-2	Alarm set value 2	-1999 to 9999 °C/°F The decimal position varies with the kind of input.	0	Not displayed if alarm mode switch 2 is set to 0.

To go to the next level, press the Level Key for 1 s min.

**Note** The values shown in Fahrenheit are applicable only for E5□J-□□□□-F Models.

#### Display Level 1

Display	Name	Setting/Display Range	Setting before shipping	Remarks	
	0	Output value display	0.0 to 100.0 %		
	CP	Control period	1 to 99 s	20	Displayed and can be set if the E5□J in PID control operation has relay control output or voltage control output.
	HYS	Hysteresis	0.1 to 999.9 °C/°F	1.0 (1.8)	Displayed and can be set when the E5□J is in ON/OFF control operation.
	SP-0	Set point 0	Set point lower limit to set point upper limit (°C/°F)	0	For models incorporating an event input function.
	SP-1	Set point 1	Set point lower limit to set point upper limit (°C/°F)	0	For models incorporating an event input function.
	SP-2	Set point 2	Set point lower limit to set point upper limit (°C/°F)	0	For models incorporating an event input 2 function. Displayed and can be set if the default value is changed on the engineering level.
	SP-3	Set point 3	Set point lower limit to set point upper limit (°C/°F)	0	For models incorporating an event input 2 function. Displayed and can be set if the default value is changed on the engineering level.
	in-S	Input shift value	-199.9 to 999.9 °C/°F	0.0	Displayed and can be set if the default value is changed on the engineering level.

Display	Name		Setting/Display Range	Setting before shipping	Remarks
	Ct	Heater current value display	0.0 to 55.0 A If the current exceeds 55.0 A, ffff will be displayed on the set value display.		For models incorporating a heater burnout alarm. Nothing is displayed if the E5□J has current control output.
	Hb	Heater burnout alarm value	0.0 to 50.0 A 0.0: Always OFF 50.0: Always ON	0.0	For models incorporating a heater burnout alarm. Nothing is displayed if the E5□J has current control output.
	P	Proportional band	0.1 to 999.9 °C/°F	8.0 (14.4)	Displayed and can be set when the E5□J is in advanced PID operation.
	i	Integral time	0 to 3999 s 0: No integral operation	233	Displayed and can be set when the E5□J is in advanced PID operation.
	d	Derivative time	0 to 3999 s 0: No derivative operation	40	Displayed and can be set when the E5□J is in advanced PID operation.
	oFr	Manual reset value	0.0 to 100.0 %	50.0	Displayed and can be set if the integral time is set to 0 when the E5□J is in advanced PID operation.

**Note** The value in the parentheses is the E5□J-□□□□-F setting before shipping.



### 3-4 Parameters on Display Level 0

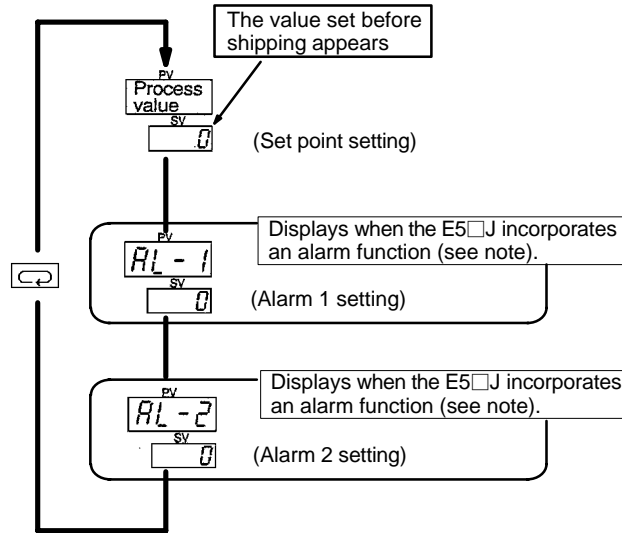

**Note:** The process value will not be displayed if the alarm mode switch is set to 0 or if the E5□J does not incorporate any alarm.

#### Set Point Setting (°C or °F)

It is possible to alter the present set point (SP0 or SP1).

#### AL-1 and AL-2 (°C or °F)

The alarm mode is factory-set to the upper limit alarm (deviation). It is possible to change the alarm mode with the alarm mode selector. Refer to 2-3-3 Alarm Mode Setting. The alarm value can be set with the deviation width or absolute value according to the alarm mode.

Deviation alarm	Absolute value alarm
Upper and lower limit alarm, upper limit alarm, lower limit alarm and upper and lower limit range alarm.	Absolute value upper limit alarm and absolute value lower limit alarm.
Set with the deviation width from the set point Alarm value 10°C/°F Set point (SP) 100°C/°F	Set with the absolute value from 0°C/°F. Alarm value 110°C/°F 0°C/°F

### 3-5 Parameters on Display Level 1

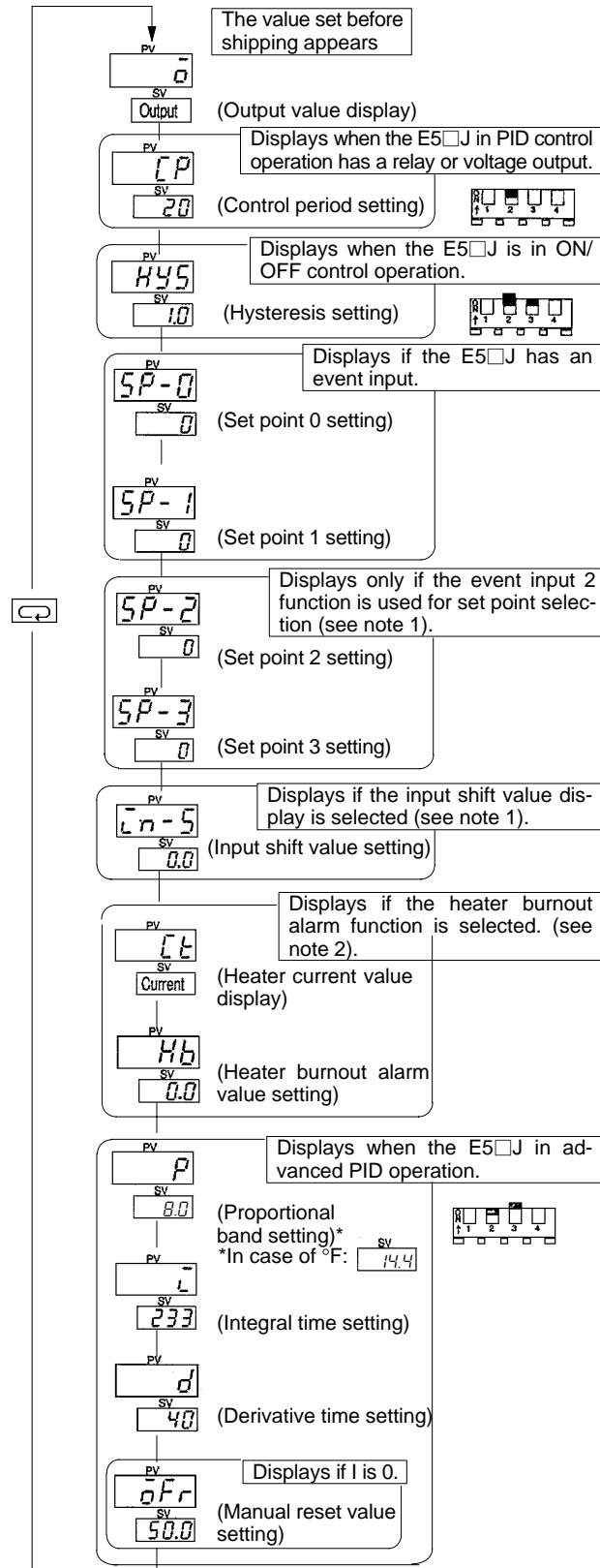

- Note**
1. Displayed if the initial value is changed on the engineering level.
  2. Not displayed if current output is used as control output or a model with no heater burnout alarm function is used.

**Output Value Display**

The output value is displayed within a range of 0.0% to 100.0%.

**Control Period Setting**

It is possible to set the control period within a range of 1 to 99 s. The control period is the period required by the E5□J to turn ON and OFF its relay output or voltage output. The ON period increases in proportion to the output value. If the control period is short, smooth control operation will be possible although a short control period shortens the life of the relay if relay output is used. Therefore, the control period should not be less than 20 s if relay output is used. The following are output examples with an output value of 50.0 %.



**Hysteresis Setting (°C or °F)**

It is possible to set the hysteresis for the E5□J in ON/OFF control operation within a range of 0.1° to 999.9°C/°F.

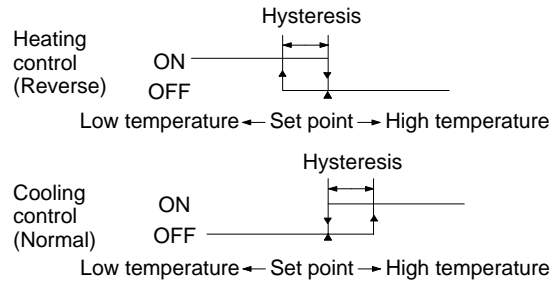

**SP-0, SP-1, SP-2, and SP-3 (E5□J-□B Only)**

It is possible to set SP-0 (set point 0), SP-1 (set point 1), SP-2 (set point 2), and SP-3 (set point 3) all in Celsius or Fahrenheit regardless of the set point presently selected. To select the set point, open or short-circuit terminals EV1 and EV2. Refer to Section 7 Event Input Function for details.

**Input Shift Value**

It is possible to set the input shift value within a range of -199.9° to 999.9°C/°F. When an input shift value is set, the process value will be the input value added with the shift value.

**Example**

Input	Input shift value	Process value
100°C	0 (no compensation)	100°C
	10.0 (compensation value)	110°C
	-10.0 (compensation value)	90°C

After the input shift value is set, it is effective even if the input shift value display is turned off on the engineering level.

**Heater Current Value Display (E5□J-□H Only)**

It is possible to set the heater current value within a range of 0.0 to 55.0 A. If the current value exceeds 55.0 A, FFFF will be displayed on the set value display. The heater current will be processed and displayed if the control output is ON.

**Heater Burnout Alarm Value Setting (E5□J-□H Only)**

It is possible to set the heater burnout alarm value within a range of 0.0 to 50.0 A, which will be used to detect heater burnout. If the heater burnout alarm value is set to 0.0 A, the heater burnout alarm output will be always OFF. If the heater burnout alarm value is set to 50.0 A, the heater burnout alarm output will be always ON. Refer to Section 8 Heater Burnout Detection for details.

When the E5□J is in advanced PID with fuzzy self-tuning mode, the following parameters (P, I, d, αFr) will not be displayed (i.e., there is no need to set the following parameters). The fuzzy self-tuning always adjusts the PID constants to the most suitable values according to the characteristics of the controlled device.

- P Proportional Band Setting** It is possible to set the proportional band within a range of 0.1 to 999.9°C/°F.
- I Integral Time Setting** It is possible to set the integral time within a range of 0 to 3999 s.
- D Derivative Time Setting** It is possible to set the derivative time within a range of 0 to 3999 s.
- oFr Manual Reset Value Setting** It is possible to set the necessary output value when the E5□J is in constant operation within a range of 0.0% to 100.0%. The E5□J will be balanced with a deviation between the set point and process value in P or PD control mode. This deviation is called offset. The offset can be removed by changing the manual reset value.

# SECTION 4

## Fuzzy Self-tuning

This section provides the procedures required to adjust all PID constants using fuzzy self-tuning according to the characteristics of the device for ideal temperature control.

4-1	Fuzzy Self-tuning Operation .....	28
4-1-1	Step Response Tuning (SRT) .....	28
4-1-2	Disturbance Tuning (DT) .....	29
4-1-3	Hunting Tuning (HT) .....	30
4-2	Troubleshooting .....	31
4-3	Terminology .....	32
4-3-1	Stable Value, Stable Range, and Stability Judgement Time .....	32
4-3-2	Hunting .....	33
4-3-3	Characteristics and Characteristics Change .....	33
4-3-4	External Disturbance .....	33
4-3-5	Interference .....	33
4-3-6	Startup .....	34

## 4-1 Fuzzy Self-tuning Operation

The fuzzy self-tuning function has three features, step response tuning (SRT), disturbance tuning (DT), and hunting tuning (HT).

### 4-1-1 Step Response Tuning (SRT)

SRT is used to obtain all PID constants using a step response method when the Temperature Controller starts operations.

SRT is also used when the set point changes value exceeding a set range while the Temperature Controller is operating. After SRT has been executed, no SRT will be executed the next time the Temperature Controller starts operating, unless the set point has been changed.

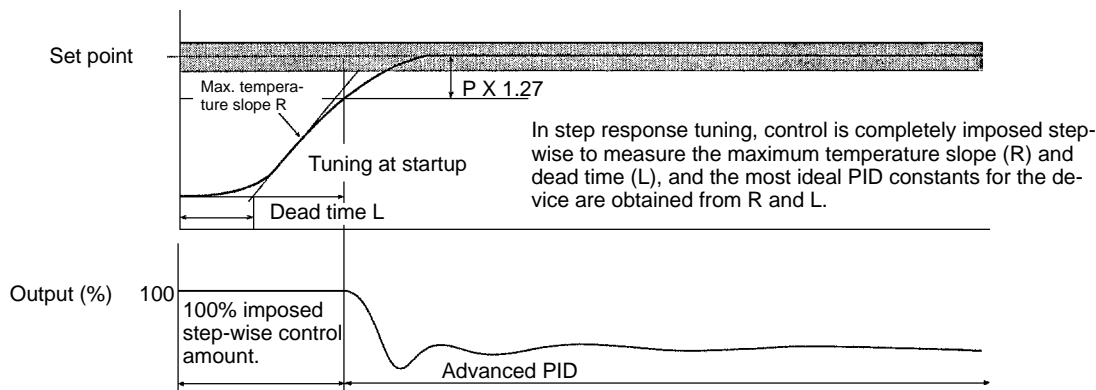

**Note** Be sure to turn on the power supply to the load either before or simultaneously with the start of Temperature Controller operation. When using the E5AJ-A2HB or E5EJ-A2HB, you can change the RUN/STOP setting to RUN via event input 2 after supplying power to the load. Dead time will be measured from the time the Temperature Controller starts operating. If a load such as a heater is turned on after the Temperature Controller is turned on, dead time longer than the actual value will be measured and inappropriate PID constants will be obtained. If an extremely large amount of dead time is measured, the control amount will be set to 0% for a short period of time before being returned to 100%, and the constants will then be returned. Retuning is performed only for large amounts of dead time, so be sure to follow the precaution given above when starting operation.

**SRT Startup Condition**

SRT will be ON if the following conditions are satisfied simultaneously when the Temperature Controller is turned on or the set point is changed.

At the time the Temperature Controller starts operating	At the time set point is changed
1) The set point at the time the Temperature Controller starts operating is different from the set point used at the time SRT was last executed (see note). 2) The difference between the set point and the process value at the time the Temperature Controller starts operating is larger than the present proportional band value (P) x 1.27 + 4. 3) The process value at the time the Temperature Controller starts operating is smaller than the set point in reverse operation and larger than the set point in normal operation.	1) The new set point is different from the set point used at the time SRT was executed last (see note). 2) The set point changing range is larger than the present proportional band value (P) x 1.27 + 4. 3) The process value is in stable condition before the set point is changed. 4) A larger set point value is set in reverse operation and a smaller set point is set in normal operation.

**Note** The last SRT-executed set point is set to 0 before shipping and when changing from advanced PID control to advanced PID control with fuzzy self-tuning.

**Imposition Completion Condition of Step Control Amount**

In order to prevent overshooting, the step controlled amount must be imposed continuously only while the present deviation is the same as or greater than the value obtained from the proportional band (P) x 1.27. The step control will not be applied when the deviation becomes smaller than this value.

**PID Constant Refreshing Conditions**

If the step control amount is applied before the maximum temperature slope (R) is obtained, SRT will not renew any PID constant. If the proportional band obtained from the R and L values that were measured before the imposition had been completed is larger than the present proportional band, the PID constants will be renewed because the measured value is in the direction towards the suitable proportional band value, and the set point at that time will be the SRT-executed set point.

**4-1-2 Disturbance Tuning (DT)**

DT is used to measure the control waveform and adjust the PID constants when the measured temperature becomes unstable. When there are control characteristic changes after the PID constants are refreshed with SRT or when the PID constants are not suitable to the object to be controlled because SRT was not executed, the PID constants will be adjusted with DT.

**DT at the Time of Operation Start and Set Value Change**

If there is overshooting at the time the Temperature Controller restarts operating after SRT has been executed, DT adjusts the PID constants so that the set point response waveform will be as close as possible to the most ideal response waveform after it is deemed that there has been a characteristics change in the control system.

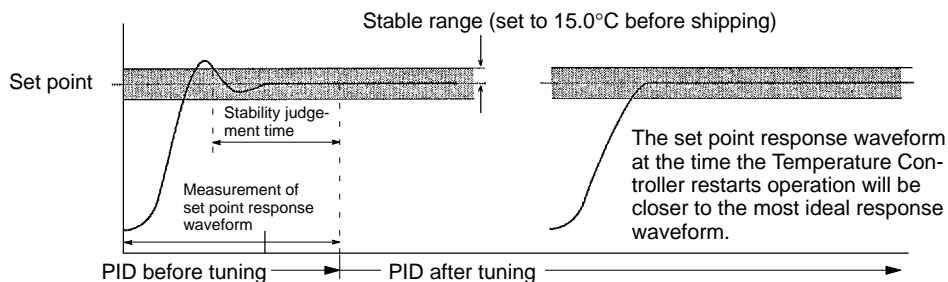

**DT at the Time of External Disturbance Response**

After the process value reaches the set point and becomes stable, if the process value is disturbed and the disturbance exceeds the stable range, the disturbance is regarded as external disturbance. At the time of disturbance, DT measures the external disturbance waveform and adjusts the PID constants so that the external disturbance response waveform will be as close as possible to the most ideal external disturbance response waveform.

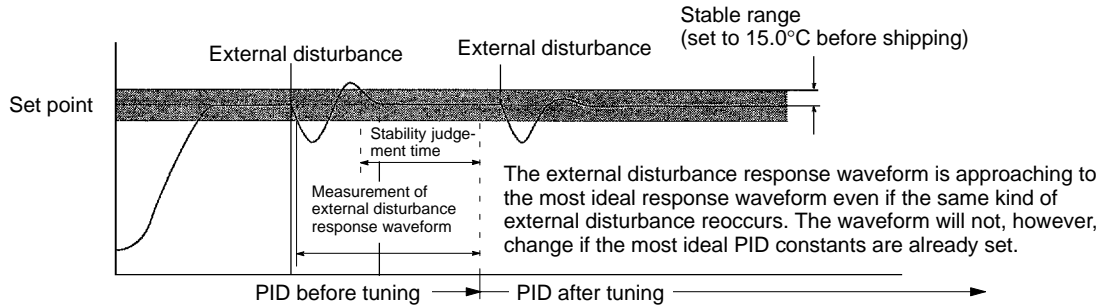

**Startup Conditions of DT**

DT is used to monitor the control waveform if there is external disturbance or SRT does not work at the time the Temperature Controller starts operating or at the time of set point change. If the measured waveform is not an ideal waveform, DT will be ON. If either one of the following conditions is satisfied, the control waveform will be monitored.

- 1, 2, 3... 1. SRT Startup conditions 3 and 4 on page 29 are satisfied but neither 1 nor 2 is satisfied.
- 2. There has been an external disturbance exceeding the stable range after the process value was in stable condition.

**Note** The stable range is set to 27°F with the E5□J-□□□□-F.

**4-1-3 Hunting Tuning (HT)**

If there is hunting due to characteristics changes of the control system, HT is used to measure the hunting waveform and adjust the PID constants to suppress the hunting.

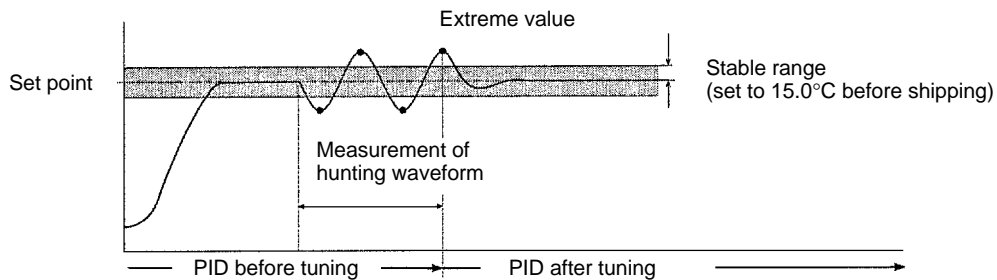

**Startup Conditions of HT**

HT will be ON when there is hunting with four or more maximum temperature values while SRT is not being executed.

**Note** If the periodic temperature changes of the application exceed the stable range (set to 15.0°C at the factory) due to continuous external disturbance (i.e., the temperature is affected by an external disturbance before stabilizing after a previous external disturbance (refer to figure A below)), the user should change the stable range to a value greater than the temperature changing range, otherwise



HT may change the PID constants even though the PID constants are ideal for the control system. Refer to 9-1 *Engineering Level* for details.

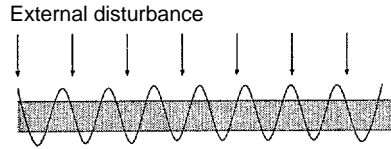

Figure A: Waveform with HT turned ON

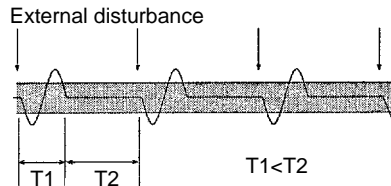

Figure B: Waveform with HT turned OFF

**Note** The stable range is set to 27°F with the E5□J-□□□□-F.

## 4-2 Troubleshooting

Fuzzy self-tuning may not exhibit its full capability due to the characteristics and conditions of the controlled object.

Refer to the following table for troubleshooting when Unit operation is not smooth.

Phenomenon	Probable cause	Countermeasure
The temperature does not reach the set point.	The dead time measured was longer than the actual value and inappropriate PID constants were obtained because the load (such as a heater) was turned on after the Temperature Controller started operating. (Refer to 4-3-6 <i>Startup</i> for details.)	Do the following to execute SRT again. <ol style="list-style-type: none"> <li>1) Set the control mode to the advanced PID and set the proportional band to 0.1°C.</li> <li>2) Set the control mode to the advanced PID with fuzzy self-tuning again.</li> <li>3) Wait until the temperature of the control system is stable, and then turn on the Temperature Controller and the load simultaneously or turn on the load first for SRT.</li> </ol>
	The PID constants were changed from the most ideal value because HT is ON continuously when there was a periodic temperature change larger than the stable range due to an external disturbance. Refer to the note under 4-1-3.	Do either one of the following so that HT will not be ON. <ul style="list-style-type: none"> <li>• Change the stable range to a wider setting than the range of the temperature change and execute SRT again by executing steps 1) to 3) above.</li> <li>• After obtaining the most ideal PID constants by executing steps 1) to 3) above, set the control mode to advanced PID.</li> </ul>

Phenomenon	Probable cause	Countermeasure
Hunting does not stop.	The control period is too long for the characteristics of the controlled device, which causes hunting in synchronization with the control period.	Shorten the control period.
	The temperature is influenced by continuous external disturbance (i.e., the temperature is affected by an external disturbance before a previous disturbance has been stabilized, and it looks as if hunting did not stop at all).	In this case, however, 100% improvement will not be possible because the temperature is influenced by a continuous external disturbance instead of hunting. Change the stable range to a wider setting than the range of the temperature change so that HT will not be ON.
The response fluctuates, becoming good and bad.	There is a heater or cooling device not controlled by the control output of the Temperature Controller (e.g., forced heating or cooling is executed using alarm outputs).	In this case fuzzy self-tuning may not work. Set the control mode to the advanced PID and adjust the PID constants manually.
The response fails to reach operational requirements.	There are continuous characteristics changes.	Do either one of the following. <ul style="list-style-type: none"> <li>Adjust the stable range so that fuzzy self-tuning will not be turned ON.</li> <li>Set the control mode to the advanced PID and adjust the PID constants manually.</li> </ul>
	The response speed of the controlled device is so fast that it cannot be retrieved by a sampling period of 500 ms.	The Thermac E5□J Temperature Controller cannot support a sampling period of less than 500 ms. Use an ES100-series Digital controller, which has a shorter sampling period.
	The temperature is affected by devices near the system.	Fuzzy self-tuning does not support any countermeasure against interference. Set the control mode to the advanced PID and adjust the PID constants manually.

## 4-3 Terminology

### 4-3-1 Stable Value, Stable Range, and Stability Judgement Time

If the measured value continuously coincides with the set point, it can be said that the measured value is stable. The measured value will not continuously coincide perfectly with the set point if there is noise interference. It is, however, possible to make the measured value stay within a permissible range called the stable range. Even if the temperature is within the stable range, the Temperature Controller may respond to external disturbance or hunting. Therefore, it cannot be said that the temperature is stable unless the temperature stays within the stable range continuously for a certain time. This time is called stability judgement time. Like PID constants, stability judgement time is adjusted with fuzzy self-tuning according to the characteristics of the object to be controlled. Fuzzy

self-tuning will not be activated if the temperature is stable because the Temperature Controller deems that temperature control is smooth.

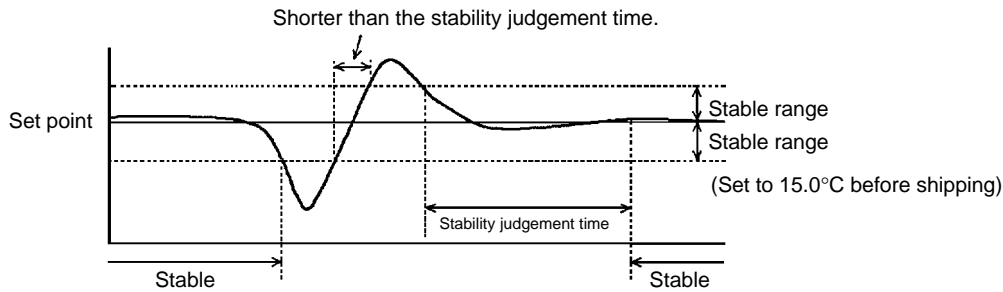

**Note** The stable range is set to 27°F with the E5□J-□□□□-F.

### 4-3-2 Hunting

If the PID constants are not suitable to the controlled device, the measured value will fluctuate and will not coincide with the set point, this phenomenon is called hunting. Hunting is also called cycling.

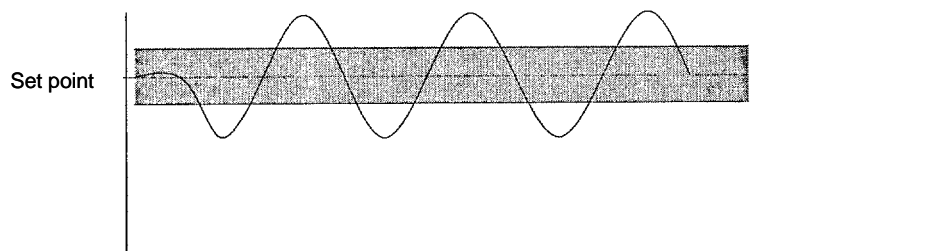

### 4-3-3 Characteristics and Characteristics Change

The angle of the maximum temperature slope (R) of the controlled device (i.e., whether the temperature rise of the device is fast or slow) and the dead time (L) of the controlled device (i.e., how fast the change in the output of the Temperature Controller influences the temperature) vary with the characteristics of the controlled device. The PID constants must be set according to the characteristics of the controlled device. A characteristics change is the change of the characteristics of the controlled device due to the change of its thermal capacity and the change of the supply voltage. If there is a characteristics change, the PID constants must be adjusted according to the new characteristics.

### 4-3-4 External Disturbance

External disturbance is an external factor that disturbs the temperature that has been stable within the most ideal PID constants for the controlled device.

### 4-3-5 Interference

If devices, such as heaters, controlled by different temperature controllers are physically close to one another, the heaters are mutually influenced and the temperature of each heater are affected. This phenomenon is called interference. If there is serious interference, it will be difficult for each temperature controller to control the device, and special controlled methods taking this interference into consideration will be required.

### **4-3-6 Startup**

Startup means that the Temperature Controller starts operating. The following conditions are required to operate the Temperature Controller.

- The Temperature Controller must be turned ON.
- No sensor error has occurred.
- If a model with event input 2 is used, event input 2 must be set to RUN. Event input 2 is set to RUN before shipping.

The Temperature Controller will not start operating until all the above conditions are satisfied.

# SECTION 5

## Installation and Wiring

This section describes the installation and wiring of the Therman E5□J Temperature Controller.

5-1	Installation .....	36
5-1-1	Dimensions and Mounting Holes .....	36
5-1-2	Mounting Method .....	36
5-2	Wiring .....	37
5-2-1	Connection .....	37
5-3	Terminal Arrangement .....	38

## 5-1 Installation

Install the E5□J in the following places.

- 1, 2, 3...
1. Where there is little mechanical vibration or shock.
  2. Where there is no corrosive gas such as sulfide gas.
  3. Where the ambient temperature is within  $-10^{\circ}$  to  $55^{\circ}\text{C}$ .
  4. Where there is no high heat radiation.
  5. Where there is no high tension lines, welding machines or other devices generating electrical noise.
  6. Where the E5□J is not influenced by any electromagnetic field.
  7. Where there is little dust or oily smoke.
  8. Where the E5□J is not sprayed with water.

### 5-1-1 Dimensions and Mounting Holes

Refer to the *Appendix Dimensions and Mounting Holes*.

### 5-1-2 Mounting Method

#### E5AJ and E5EJ

Open a square hole in the panel to which the E5□J is to be mounted, mount the E5□J, attach the two mounting brackets provided with the E5□J to the upper and lower sides of the E5□J, and secure them with a Phillips screwdriver by turning the Phillips screwdriver clockwise until the ratchets of the mounting brackets click.

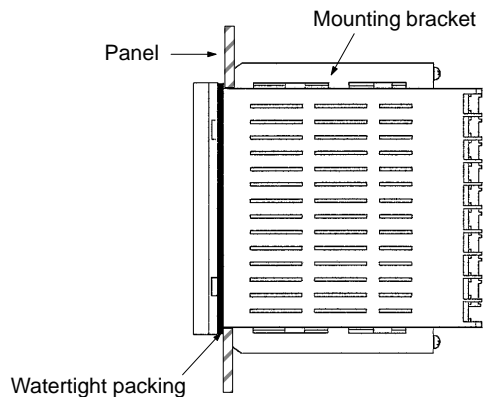

#### E5CJ

Open a square hole in the panel to which the E5CJ is to be mounted, mount the E5CJ, attach the adapter provided with the E5CJ as shown in the following illustration to reduce the space between the E5CJ and panel, and secure the adapter with the tightening screw.

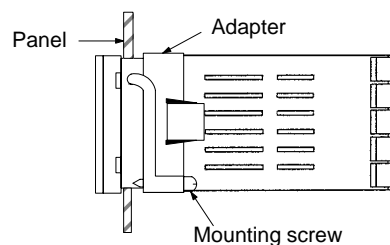

## 5-2 Wiring

Refer to the terminal arrangements to wire the E5□J. Before wiring, observe the following.

- 1, 2, 3...
1. When connecting extension wires to the thermocouple, use proper compensating lead wires.
  2. When connecting extension wires to the platinum resistance thermometer, use three low-resistance wires of equal resistance.
  3. The power supply must not be influenced by noise. If necessary use a noise filter.
  4. All the wires connected to the input circuitry must be separated from the wires connected to the power supply or output circuitry.
  5. Use shielded wires where static inductance noise is present.
  6. Twist the input wires evenly and closely if there is any electromagnetic inductance noise.

### 5-2-1 Connection

#### With Solderless Terminals

Use solderless terminals for M3.5 screws. The terminal screws are M3.5 x 8 self-up screws.

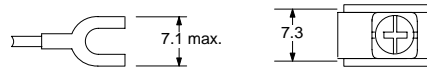

#### Solder-dipped Leads

It is possible to connect solder-dipped leads to the terminals with ease. The length of each bare lead wire should be 6 to 8 mm.

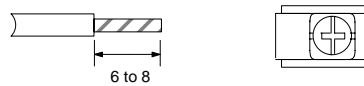

For side-by-side mounting, Thermac J-series Temperature Controllers are designed so that all the lead wires can be connected to the terminals in the same direction.

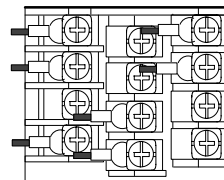

# 5-3 Terminal Arrangement

## E5AJ/E5EJ Standard Model

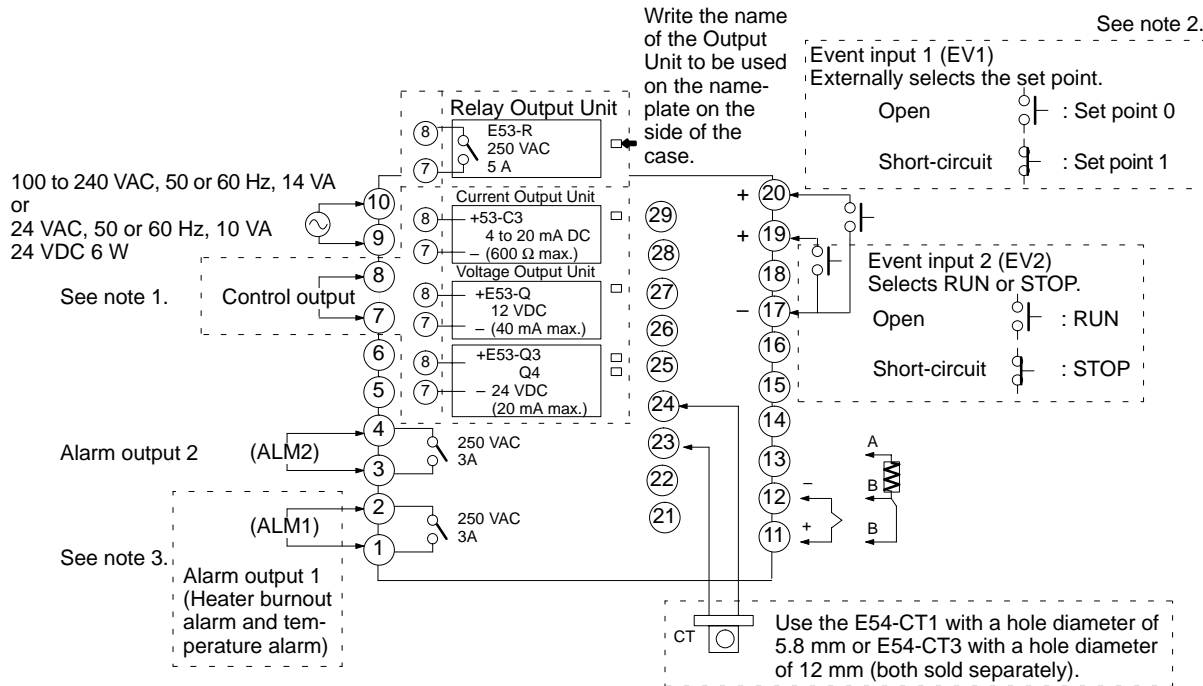

- Note**
1. The E53-C cannot be used.
  2. The event input terminals and voltage output and current output terminals are not insulated.
  3. Only the heater burnout alarm will be output from the alarm output 1 terminals if alarm mode switch 1 is set to 0. Only the temperature alarm will be output if the heater burnout alarm value is set to 0.0 A.

## E5AJ/E5EJ with Communications Function

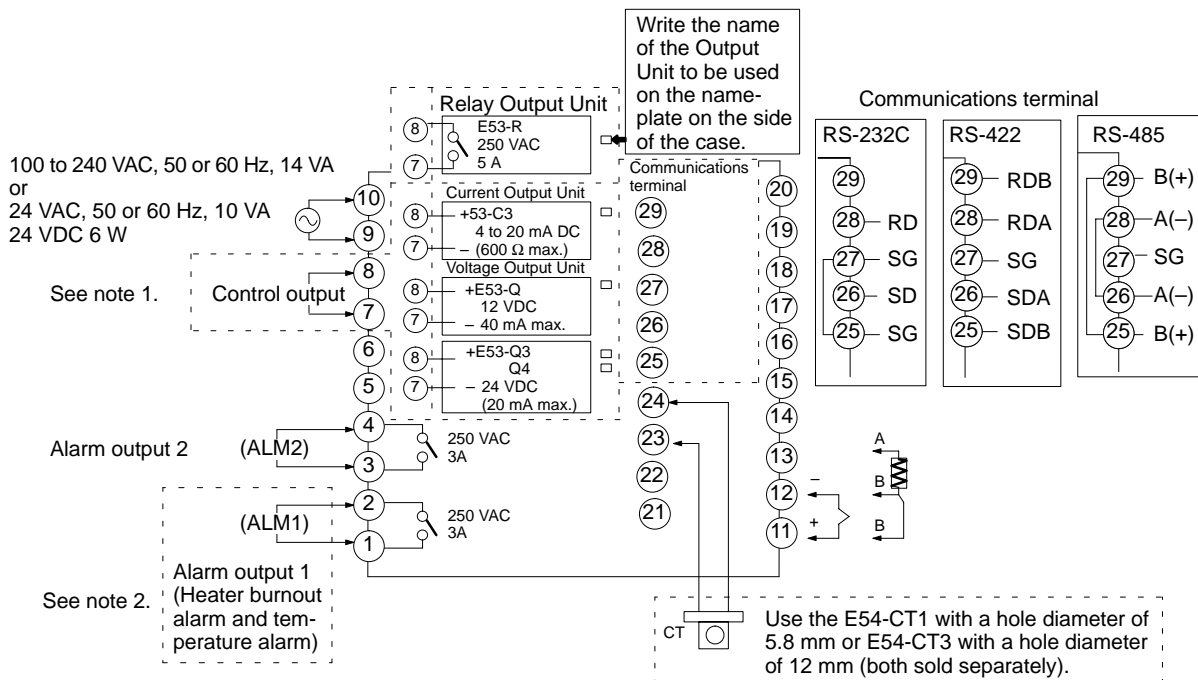

- Note**
1. The E53-C cannot be used.



- Only the heater burnout alarm will be output from the alarm output 1 terminals if alarm mode switch 1 is set to 0. Only the temperature alarm will be output if the heater burnout alarm value is set to 0.0 A.

## E5CJ Standard Model

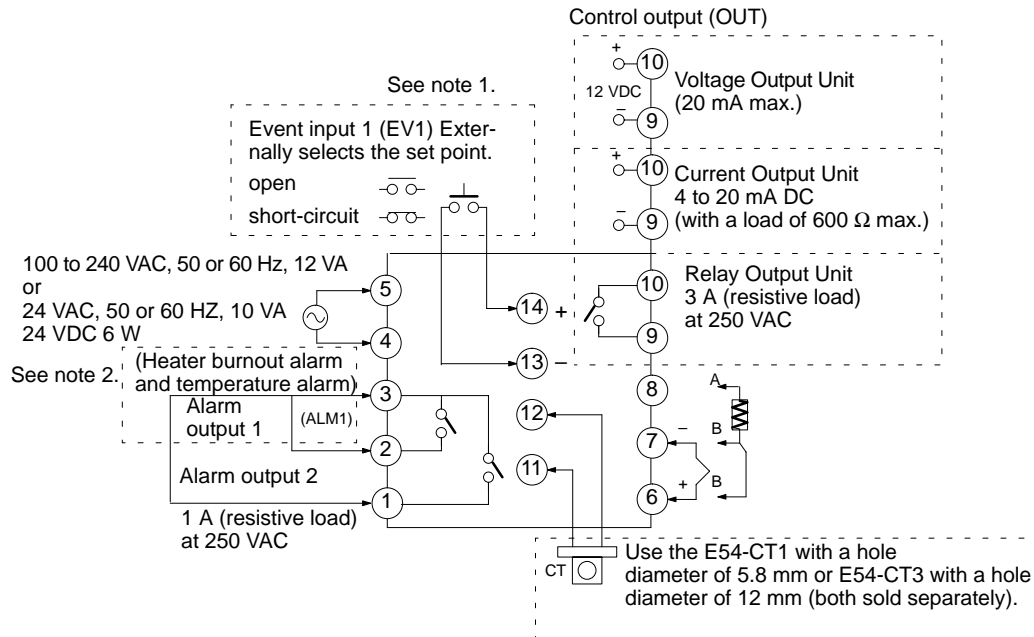

- Note**
- The event input terminals and voltage output and current output terminals are not insulated.
  - Only the heater burnout alarm will be output from the alarm output 1 terminals if alarm mode switch 1 is set to 0. Only the temperature alarm will be output if the heater burnout alarm value is set to 0.0 A.
  - A simple model with no alarm does not incorporate any event input or alarm output. A simple model with an alarm function does not incorporate any event input.

# SECTION 6

## Troubleshooting

This section describes the troubleshooting of the Thermac E5□J Temperature Controller.

6-1	Error Display and Output .....	42
6-2	Troubleshooting .....	42

## 6-1 Error Display and Output

The Thermac E5□J Temperature Controller incorporates a self-diagnostic function. The following table lists the process values and outputs that the E5□J has when errors result.

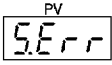
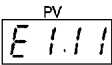
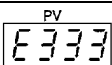
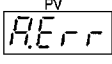
PV display	Error	Output		Items to be checked
		Control output	Alarm output	
	Abnormal input	OFF (2 mA max.)	Processed as an abnormally high temperature.	<ul style="list-style-type: none"> <li>Whether or not the input has exceeded the possible controlling range (<math>\pm 10\%</math> of the set temperature range) (see note).</li> <li>Whether or not the setting of the input type is incorrect.</li> <li>Whether or not the input has been incorrectly wired, broken, or short-circuited.</li> </ul>
	Abnormal memory	OFF (2 mA max.)	OFF	Turn the E5□J OFF and ON. If the display does not change, the E5□J need repairs. If the display returns to normal, the E5□J may have been influenced by noise. Check for noise interference.
	Abnormal A/D converter	OFF (2 mA max.)	OFF	
	Abnormal calibration data. Displayed for 2 s when the E5□J is turned on.	Normal operation (accuracy not guaranteed)		The E5□J needs calibration. Contact your OMRON representative.

**Note** If the input is within the possible controlling range but exceeding the possible display range (–1999 to 9999), *EEEE* will be displayed if the value is smaller than –1999 and *JJJJ* will be displayed if the value is larger than 9999, at which time, the control output and alarm output will work normally.

## 6-2 Troubleshooting

Refer to the following table for troubleshooting.

Phenomenon	Probable cause	Countermeasure
Nothing is displayed when the E5□J is turned on.	The internal mechanism is not inserted properly into the housing.	Properly insert the internal mechanism into the housing.
	The power supply is not connected to the power supply terminals properly.	Properly connect the power supply to the power supply terminals.
	No power is supplied or the supplied power is not within the specified range.	Supply a voltage of 85 to 264 VAC to the power supply terminals of the E5□J.
No setting is possible.	The key protection switch is set to ON.	Set the key protection switch to OFF.
	The E5□J with a communications function is in remote mode.	The E5□J must be in local mode or no front key is available.
When the Up Key is pressed for set point value setting, the value flashes within the set temperature range and the setting is not possible.	The set point limit function is active.	Properly set the set point lower limit and set point upper limit values.
No alarm, heater current value display, or heater burnout alarm is displayed.	The alarm mode switch is set to 0.	Select the proper alarm mode.
	A Current Output Unit is used for control output.	No heater burnout is detected if the Current Output Unit is used for control output.

Phenomenon	Probable cause	Countermeasure
The process value is abnormal or not obtained.	The input polarity is wrong or the connection is wrong.	Properly wire the terminals.
	The input-type setting is incorrect.	Properly set the input with the input-type selector.
	No compensating lead wires are used for the extension of the thermocouple.	Use proper compensating lead wires.
	The thermocouple and E5□J is connected via wires other than proper lead wires.	Use a dedicated thermocouple connector. If a metal material different from the thermocouple is used to connect the thermocouple and E5□J, a temperature error may result.
	The sensor is broken or short-circuited.	Use a good sensor.
	The E5□J is influenced by noise or other induction.	Separate the input wires as far as possible from the origin of the noise.
	°C is used instead of °F or vice versa.	Use the proper temperature unit.
	The process value is shifted because the input shift function is used.	Set the input shift value to 0.
No control output is obtained.	No Control Output Unit is connected.	Connect a Control Output Unit (sold separately).
	Event input 2 of the E5□J is set to STOP.	Open event input 2 and set the E5□J to RUN.
The heater burnout detecting function is abnormal.	No Current Transformer (CT) is used.	Properly connect the dedicated E54-CT1 or E54-CT3 (sold separately) to the E5□J.
	The heater burnout alarm value is not proper.	Set the proper heater burnout alarm value taking into consideration the fluctuation of the heater supply voltage and measurement error.
	The heater is turned ON or OFF with an output other than the control output.	Use the control output. Heater burnout detection synchronizes with the control output. Any other output cannot be used.

### Simple Method to Determine Temperature Controller Error or Sensor Error

**When Thermocouple is Used** If the temperature displayed by the E5□J is close to the room temperature when the input terminals of the E5□J is short-circuited, the E5□J deemed to be normal and it is presumed that the sensor is broken, short-circuited, or incorrectly wired.

**When Platinum Resistance Thermometer is Used** If the temperature displayed by the E5□J is close to 0.0°C when a resistor with a resistance of approximately 100 Ω is inserted between terminals A and –B of the E5□J and terminals +B and –B of the E5□J are short-circuited, the E5□J deemed to be normal and it is presumed that the sensor is broken, short-circuited, or incorrectly wired.

# SECTION 7

## Event Input Function

This section describes how the event input function of the Tharmac E5□J Temperature Controller works.

7-1	Event Input Function .....	46
7-1-1	Set Point Selection .....	46
7-1-2	RUN/STOP Selection (E5AJ-□B, E5EJ-□B) .....	46
7-1-3	Signal Input Method .....	47

# 7-1 Event Input Function

The E5□J-□B with an event input function is operated with ease with external relay signal selection.

## Set Point Selection

It is possible to select one of the set points previously set for control operation.

## RUN/STOP Selection

It is possible to enable the E5AJ-□B and E5EJ-□B to RUN or STOP.

### 7-1-1 Set Point Selection

Select the set point by opening or short-circuiting event input 1 (EV1). Refer to the following table. No set point can be selected with key operation.

EV1	Set point to be selected
Open	Set point 0 (SP0)
Short-circuited	Set point 1 (SP1)

The following illustration shows the operation of the E5□J-□B with its EV1 terminal short-circuited (i.e., set point 1 is selected).

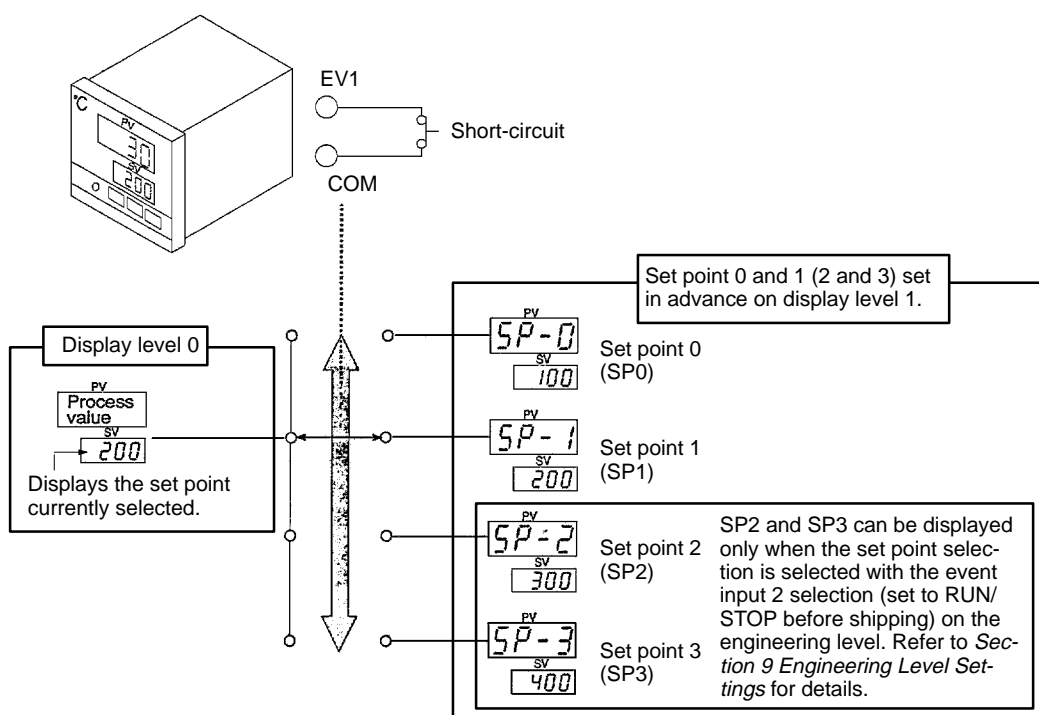

The set point on display level 0 and that on display level 1 are synchronized. In the above example, if the set point on display level 0 is changed from 200°C to 250°C, the set point 1 value on display level 1 will also change to 250°C.

### 7-1-2 RUN/STOP Selection (E5AJ-□B, E5EJ-□B)

RUN or STOP operation is selected by opening or short-circuiting event input 2 (EV2). Refer to the following table. RUN or STOP operation cannot be selected with key operation.

EV2	Operation
Open	RUN
Short-circuited	STOP

When the E5□J stops operating, its control output will be 0% and fuzzy self-tuning will stop but its alarm output will operate normally.

The operation of the E5□J the moment the E5□J is turned on is determined by the condition of event input 2.

### 7-1-3 Signal Input Method

The event input terminals can be short-circuited using a relay or transistor as shown in the following diagram.

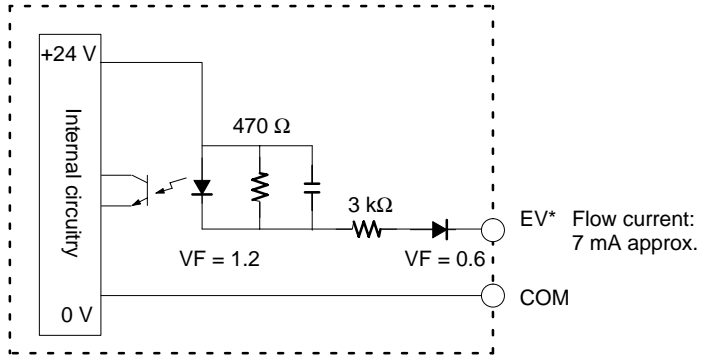

### Signal Input Types

#### Contact Input



ON: A resistance of 1 kΩ max.  
OFF: A resistance of 100 kΩ min.

#### No-contact Input (Open collector)

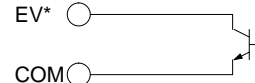

ON: A residual voltage of 3 V max.  
OFF: A current leakage of 1 mA max.

The following table lists the event input terminal numbers for each model.

Model	E5AJ/E5EJ	E5CJ
<b>Input terminal</b>		
EV1	20	14
EV2	19	---
COM	17	13

# SECTION 8

## Heater Burnout Detection

This section describes the basic features of heater burnout detection and necessary steps that should be taken at the time of heater burnout, as well as the method of obtaining heater burnout alarm values.

8-1	Heater Burnout Detection .....	50
8-2	Heater Burnout Procedures .....	50
8-3	Wiring the Current Transformer .....	51
8-4	Heater Burnout Alarm Value .....	51
8-4-1	Setting Examples .....	52



## 8-1 Heater Burnout Detection

To detect heater burnout, wire one of the lead wires for each heater through the hole of the Current Transformer (CT). The CT generates an AC current according to the current flow of the lead wire. The Thermac E5□J Temperature Controller measures the AC current to check the current flowing to the heater. If any one of the heaters burns out, the AC current value will decrease so that the E5□J turns its heater burnout alarm ON, comparing the AC current value with the heater burnout alarm value.

## 8-2 Heater Burnout Procedures

The E5□J starts heater burnout detection from the moment the E5□J is turned on. If any one of the heaters is turned on after the E5□J is turned on, the heater burnout alarm output will be ON because the E5□J judges that the heater is burnt out. Therefore, all the heaters must be turned on simultaneously with the E5□J or before the E5□J is turned on. This is essential for smooth temperature control and fuzzy self-tuning.

The E5□J will continue temperature control even if the heater burnout alarm is ON because the E5□J will continue temperature control using the heaters that are not burnt out.

Heater burnout detection is possible when the control output is ON. No heater burnout detection is, however, possible if the control output is ON for less than 190 ms.

The heater burnout alarm output will be held once the heater burnout is detected. To reset the heater burnout alarm output, replace the burnout heater with a good one and take one of the following steps.

- 1, 2, 3...**
1. Set the heater burnout alarm value to 0.0 A.
  2. Turn the E5□J off and on.

If the difference between the normal heater current value and heater burnout current value is comparatively small, heater burnout detection will not be stable. For stable detection, the difference must be 1.0 A minimum if the heater current consumption is less than 10.0 A and 2.5 A minimum if the heater current consumption is 10.0 A or more.

Heater burnout detection is not possible if the E5□J has current output, the heater current is DC, or three-phase heaters are used.

Use the K2CU-F□□A-□GS (with gate input terminals) for three-phase heater burnout. Refer to the K2CU-F□□A-□GS data sheet specifications for details.

If no heater burnout detection is executed or if no CT is used, set the heater burnout alarm value to 0.0 A. The heater burnout alarm value is factory-set to 0.0 A.

### 8-3 Wiring the Current Transformer

Refer to the following diagram for the wiring the CT.

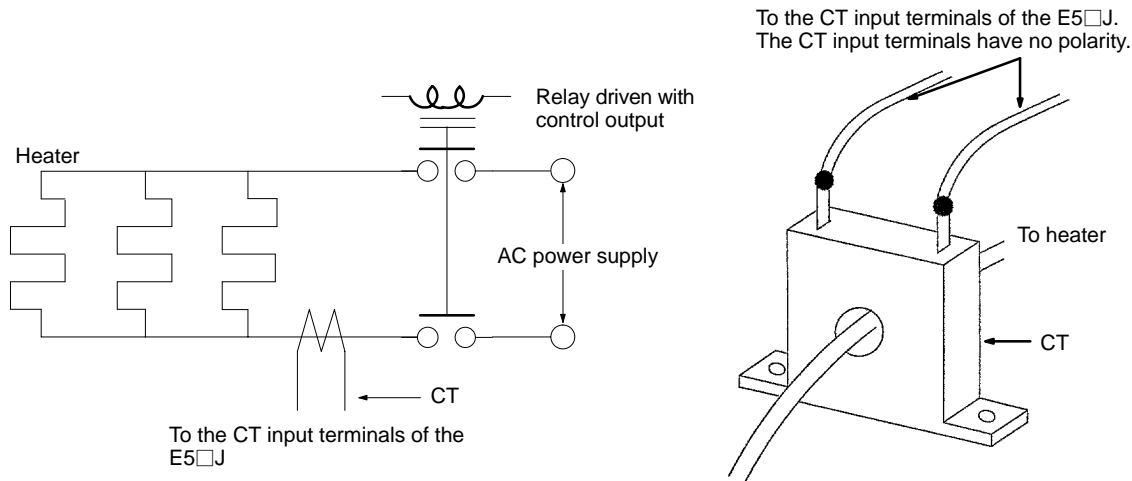

### 8-4 Heater Burnout Alarm Value

To obtain the proper heater burnout alarm value, check the normal heater current value and heater burnout current value with the heater current value display on display level 1 first and set the heater burnout alarm value to the mean value of these two values. If more than one heater is used, check the burnout value of the heater with the smallest current consumption value.

$$\text{Heater burnout alarm value} = \frac{\text{Normal heater current value} + \text{Heater burnout current value}}{2}$$

If the difference between the normal heater current value and heater burnout current value is comparatively small, heater burnout detection will not be stable. For stable detection, the difference must be 1.0 A minimum if the heater current consumption is less than 10.0 A and it must be 2.5 A minimum if the heater current consumption is 10.0 A or more.

If normal current value < 10.0 A  
 Then normal current value – heat burnout current value ≥ 1.0 A

If normal current value ≥ 10.0 A  
 Then normal current value – heater burnout current value ≥ 2.5 A

The heater burnout alarm value can be set within a range of 0.0 to 50.0 A. If the alarm value is set to 0.0 A or 50.0 A, no heater burnout detection is possible. The alarm output is always OFF if the alarm value is set to 0.0 A and always ON if the alarm value is set to 50.0 A.

The normal heater current value should be 50.0 A max. The heater current value can, however, display up to 55.0 A. If the current value exceeds 55.0 A, CT input overflow will result and FFFF will be displayed.

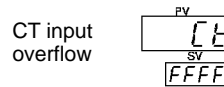

### 8-4-1 Setting Examples

#### Example 1

In this example, 1-kW, 2-kW, and 3-kW heaters at 200 VAC are connected in parallel.

- 1, 2, 3... 1. Turn the control output ON and check the normal heater current value from the heater current value display.

$$\text{Normal current} = (1000 + 2000 + 3000) \div 200 = 30.0 \text{ A}$$

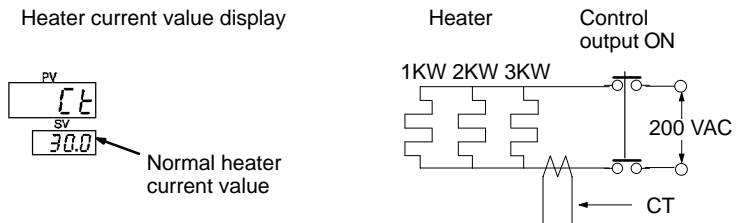

2. Disconnect the heater whose current consumption is smallest and compare the heater current value from the heater current value display.

$$\text{Heater burnout current} = 30.0 - 1000 \div 200 = 25.0 \text{ A}$$

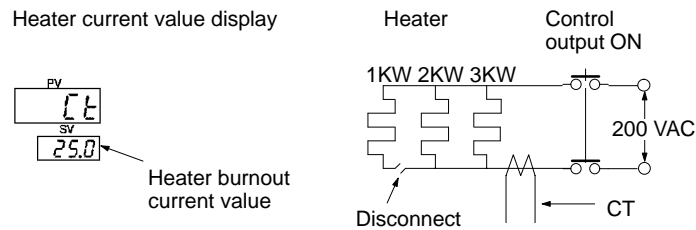

$$\text{Normal current} - \text{heater burnout current} = 30.0 - 25.0 = 5 \text{ A} (\geq 2.5 \text{ A})$$

3. Set the heater burnout alarm value to the mean value of the normal current value and heater burnout current value.

$$\text{Heater burnout alarm value} = (30.0 + 25.0) \div 2 = 27.5 \text{ A}$$



#### Example 2

In this example, 400-W, 1700-W, and 2000-W heaters at 200 VAC are connected in parallel and the difference between the normal current value and heater burnout current value is less than 2.5 A.

- 1, 2, 3... 1. Obtain the normal current value and heater burnout current value in advance as follows:

$$\text{Normal current} = (400 + 1700 + 2000) \div 200 = 20.5 \text{ A}$$

$$\text{Heater burnout current} = 20.5 - 400 \div 200 = 18.5 \text{ A}$$

Normal current - heater burnout current = 20.5 - 18.5 = 2.0 A (Stable detection is not possible because the value is not 2.5 A or more.)

2. For stable heater burnout detection, in such a case, increase the number of turns of the wire passing through the CT as if apparent current value in-

creases. The displayed heater current value increases in proportion to the number of turns of the wire passing through the CT.

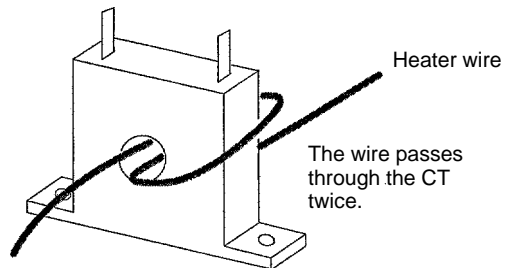

3. Obtain the heater burnout alarm value using the method in example 1.

$$\text{Apparent normal current} = (400 + 1700 + 2000) \div 200 \times 2 = 41.0 \text{ A}$$

Normal heater current value



$$\text{Apparent heater burnout current} = (41.0 - 400 \div 200) \times 2 = 37.0 \text{ A}$$

Heater burnout current value



$$\text{Normal current} - \text{heater burnout current} = 41.0 - 37.0 = 4.0 \text{ A } (\geq 2.5 \text{ A})$$

$$\text{Heater burnout alarm value} = (41.0 + 37.0) \div 2 = 39.0 \text{ A}$$

Heater burnout alarm setting



# SECTION 9

## Engineering Level Settings

This section describes the parameters that can be changed on the engineering level. These parameters should be changed only when the values set before shipping do not suit the application. After these parameters are changed on the engineering level, record the contents of the changes for your future reference.

9-1	Engineering Level .....	56
9-2	Engineering Level Parameter List .....	56
9-3	Engineering Level Parameters .....	58

## 9-1 Engineering Level

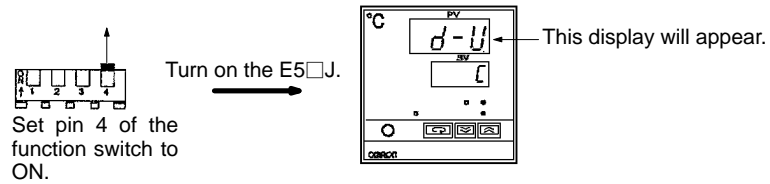

To go to engineering level, set pin 4 of the internal function switch of the E5□J to ON before turning the E5□J on. After this setting, set pin 4 of the internal function switch to OFF.



## 9-2 Engineering Level Parameter List

The following is a list of engineering level parameters.

Display	Name		Setting range	Setting before shipping	User's remarks
	d-U	°C/°F selection	℃: °C ℱ: °F	℃	
	LEn	Data bit length	7: Data length of 7 bits 8: Data length of 8 bits	7	
	PrtY	Parity check	nōnE: No parity EuEn: Even ōdd: Odd	EuEn	
	Sbit	Stop bit length	1: 1 bit 2: 2 bits	2	
	S.t-b	Stable range	0.1 to 999.9 °C/°F	15.0 (27.0)	
	ALFA	Alpha	0.00 to 1.00	0.65	
	rEt	Automatic return of display mode	0 to 99 s 0: No automatic return	0	
	rEst	Standby sequence reset method	0: Reset method 0 1: Reset method 1	0	
	in-S	Input shift display	ōFF: Not displayed ōn: Displayed	ōFF	
	ALH1	Alarm 1 hysteresis	0.1 to 999.9 °C/°F	0.2 (0.4)	
	ALH2	Alarm 2 hysteresis	0.1 to 999.9 °C/°F	0.2 (0.4)	
	SL-L	Set point lower limit value	Set range lower limit to set point upper limit value (see note 1). (°C/°F)	-200 (-300)	

Display	Name		Setting range	Setting before shipping	User's remarks
	SL-H	Set point upper limit value	Set range lower limit value to set range upper limit value (see note 1). (°C/°F)	1300 (2300)	
	EV-2	Event input 2 type selection	0: Set point selection (SP2, SP3) 1: RUN/STOP	1	

- Note**
1. The decimal position varies with the input type.
  2. The value in the parentheses is the E5□J-□□□□-F setting before shipping.

# 9-3 Engineering Level Parameters

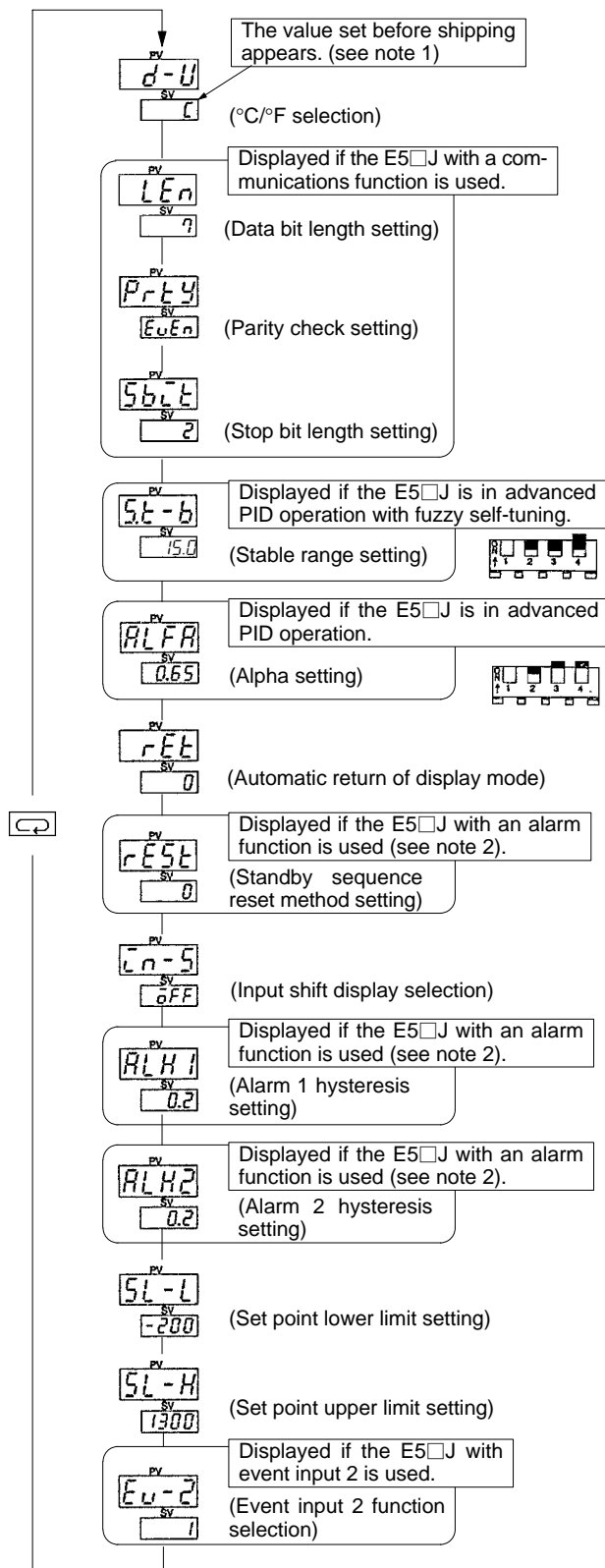

- Note:**
1. The E5□J-□□□□-F values set before shipping may be different. Refer to 9-2 Engineering Level Parameter List.
  2. The value will not be displayed if the alarm mode switch is set to 0 or if the E5□J does not incorporate any alarm.



**rd-U °C/°F Selection**

To change the temperature display unit from °C to °F, press the Up Key so that f will be displayed in the set value display.

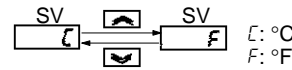

**E5□J with Communications Function**

The communications specifications of the E5□J are as follows:

Data bit length: ASCII 7- (set before shipping) or 8-bit code

Parity check: None, even (set before shipping), or odd

Stop bit length: 1 or 2 (set before shipping)

Use the following parameters to change the above setting.

**LEn Data Bit Length**

Use this parameter to change the communications data bit length.

**PrtY Parity Check**

Use this parameter to change the communications parity check.

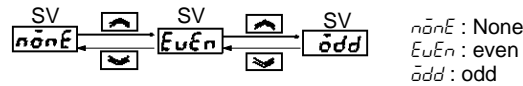

**StB Stop Bit**

Use this parameter to change the stop bit length.

**St-b Stable Range (°C/°F)**

This parameter is used to decide conditions under which fuzzy self-tuning operates and can be set within a range of 0.1 to 999.9. If the absolute value of the deviation (the difference between the process value and set point) is within the stable range, temperature control operation is deemed smooth and fuzzy self-tuning will not start.

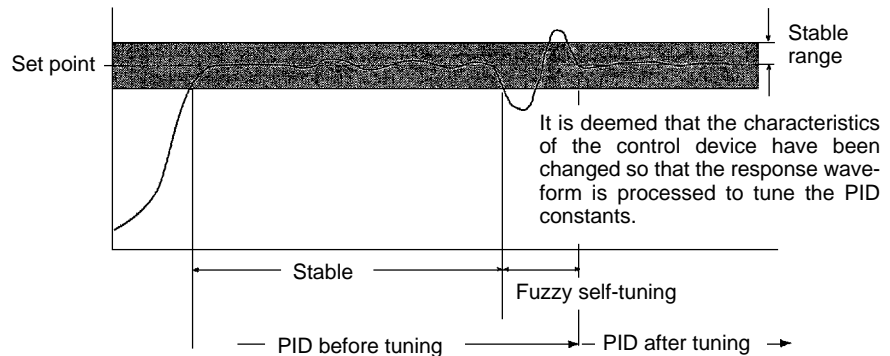

**ALFR (α) PID Control Type**

By adjusting internal parameter α of advanced PID within a range of 0.00 to 1.00, PID control such as derivative preceding PID or proportional preceding PID (I-PD) control will be possible.

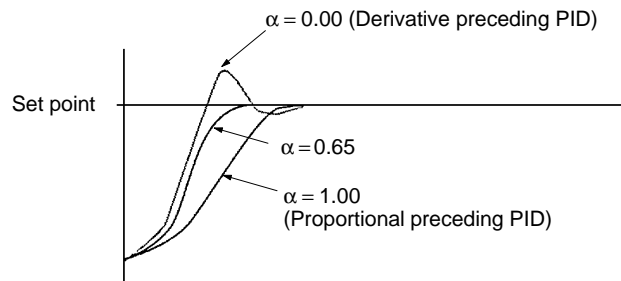

Difference in set point response due to α.

To increase the set point response speed, decrease the value of parameter α. If the value of parameter α is decreased, however, the overshooting value will increase.

**rEt Automatic Return of Display Mode (Return Time)**

By setting automatic return of display mode, the display will return to the normal operation display (on level 0 displaying the process value or set point) if no key is operated for the time set with this parameter. The return time can be set within a range of 0 to 99 s. If the return time is set to 0 s, this function will not work. The return time is set to 0 s before shipping.

**rESL Standby Sequence Reset Method**

It is possible to select the restart conditions of the standby sequence of the alarm attached with standby sequence. If this parameter is set to 0, the standby sequence will restart when the set point, alarm value, or input shift value is changed or the moment the E5□J starts operating including the moment the E5□J is turned on. If this parameter is set to 1, the standby sequence will restart only the moment the E5□J is turned on. The following timing chart is an example of a lower limit alarm attached with standby sequence.

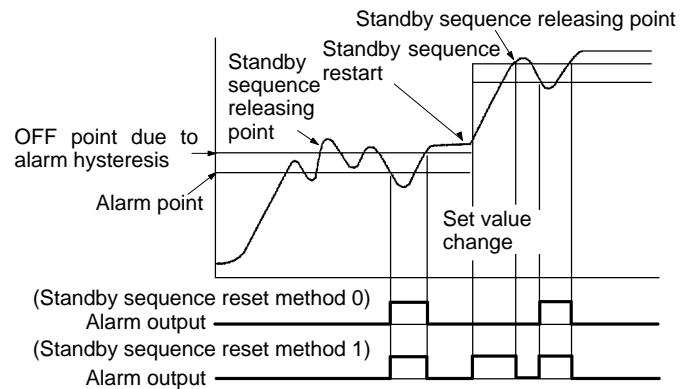

**Ln-5 Input Shift Display**

It is possible to select to display or not to display the input shift function on display level 1 with this parameter.

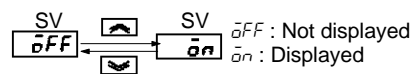

**ALH1 Alarm 1 Hysteresis and ALH2 Alarm 2 Hysteresis**

It is possible to adjust alarm sensitivity with both these parameters within a range of 0.1 to 999.9. Change the alarm sensitivity of the E5□J if the alarm output chatters.

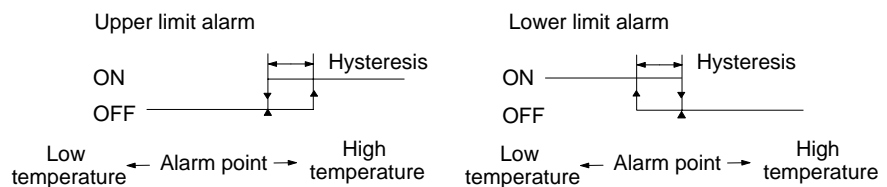

The alarm output will be OFF when the process value is within the alarm hysteresis range when the E5□J restarts (e.g., when the E5□J is turned on).

**SL-1 Set Point Lower Limit Value (°C/°F) and SL-H Set Point Upper Limit Value (°C/°F)**

It is possible to limit the set point changeable range with both these parameters. For example, if the set point lower limit value is set to 0°C and the set point upper limit value is set to 400°C, the set point can be changed only between 0°C and 400°C.

**EV-2 Event Input 2 Type Selection**

It is possible to select the function of event input 2. If 0 (set point value selection) is selected, *SP-2* and *SP-3* will be displayed on display level 1 and if 1 is selected RUN/STOP will be selected. When 0 is selected, the set point can be selected from the following.

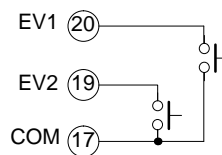

EV1	EV2	Set point to be selected
Open	Open	SP0
Short-circuit	Open	SP1
Open	Short-circuit	SP2
Short-circuit	Short-circuit	SP3

# SECTION 10

## Auto-tuning

This section describes how to execute auto-tuning.

10-1 Starting Auto-tuning .....	64
10-2 Conditions that Prevent Auto-tuning .....	64
10-3 Force-ending Auto-tuning .....	64
10-4 Changing Parameters during Auto-tuning .....	64

## 10-1 Starting Auto-tuning

Auto-tuning can be started by using the following procedure. Use this procedure when appropriate results are not achieved via fuzzy self-tuning.

- 1, 2, 3...
1. Turn ON pin 3 of the function selector switch to select the advanced PID control mode (refer to *Section 2-3-5*).
  2. Press the Level Key and the Display Key simultaneously for 1 s or longer to start auto-tuning.

## 10-2 Conditions that Prevent Auto-tuning

You will not be able to start auto-tuning when any of the following conditions exist.

- When the control mode is set for ON/OFF control or advanced PID control with fuzzy self-tuning.
- When an engineering level parameter is displayed.
- When the key protection switch is set to  $\overline{SP}$  or ALL.
- When the remote/local setting is set to remote.
- When the RUN/STOP setting is set to STOP.
- When a sensor error, memory error, or A/D converter error has occurred.

## 10-3 Force-ending Auto-tuning

Auto-tuning will be forced to end for any of the following conditions.

- When the Temperature Controller is turned off.
- When the RUN/STOP setting is changed to STOP.
- When a sensor error occurs.
- When the Level Key and the Display Key are pressed simultaneously for 1 s or longer.

## 10-4 Changing Parameters during Auto-tuning

- Parameters cannot be changed during auto-tuning, but the remote/local setting can be changed.
- The SP also cannot be changed via the event input during auto-tuning, but the event input status can be changed and the SP will be changed after auto-tuning has been completed.

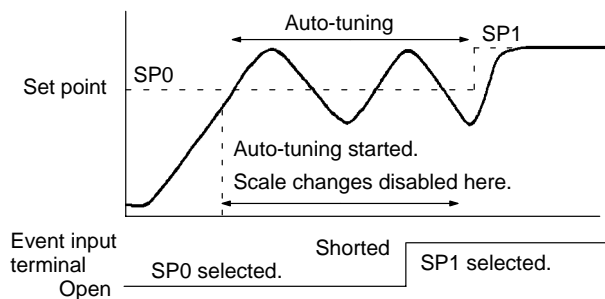

# Appendix A

## Dimensions/Mounting Holes

### E5AJ

#### Dimensions

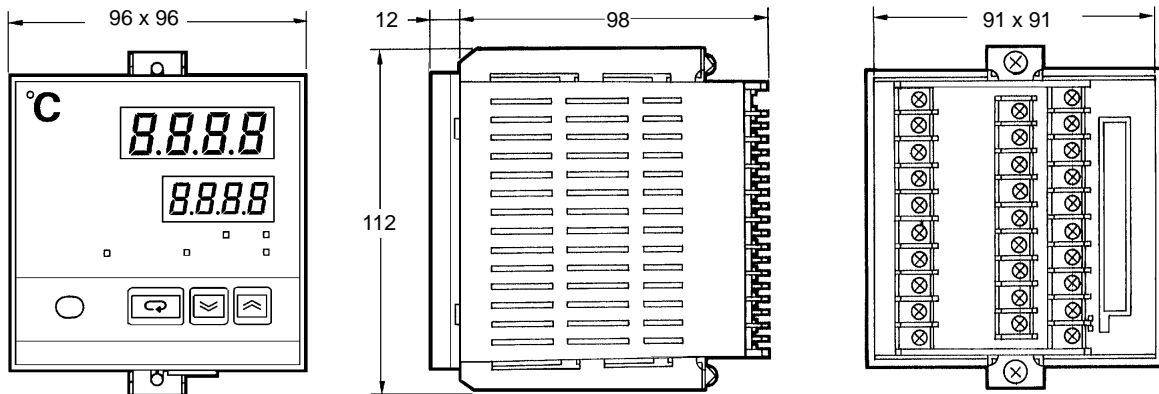

#### Mounting Holes

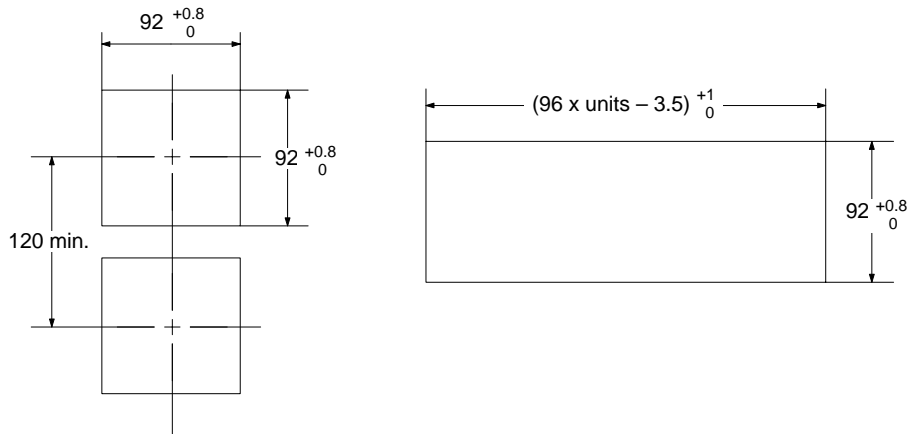

- Note**
1. All dimensions shown are in millimeters.
  2. Side-by-side close mounting is not possible for E5AJs equipped with the Watertight Cover (sold separately).

# E5EJ

## Dimensions

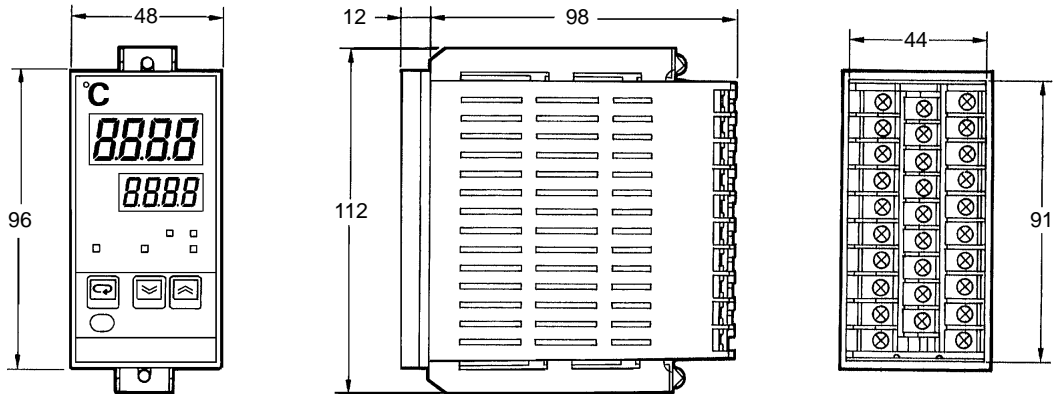

## Mounting Holes

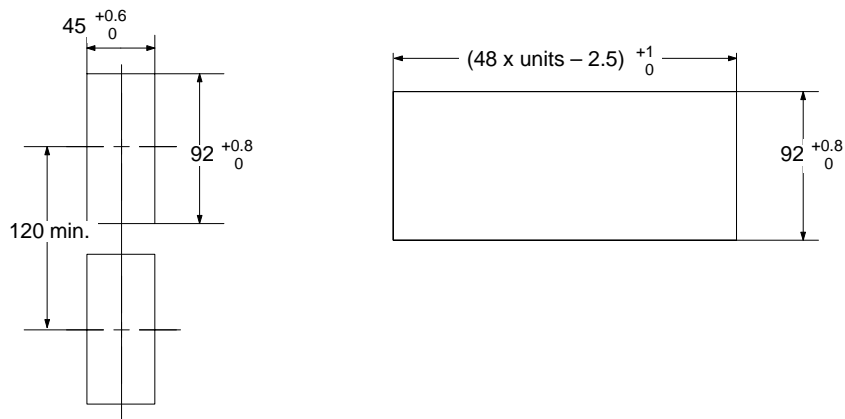

**Note** 1. All dimensions shown are in millimeters.

2. Side-by-side close mounting is not possible for E5EJs equipped with the Watertight Cover sold separately).

# E5CJ

## Dimensions

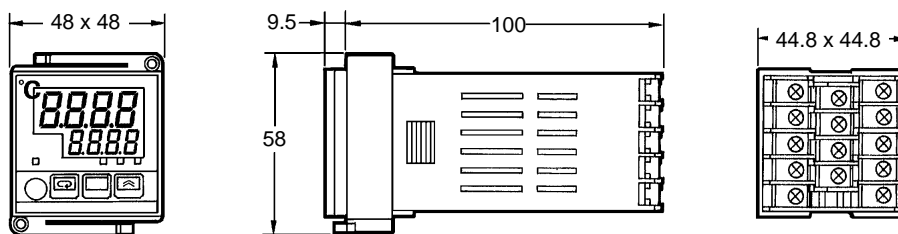

## Mounting Holes

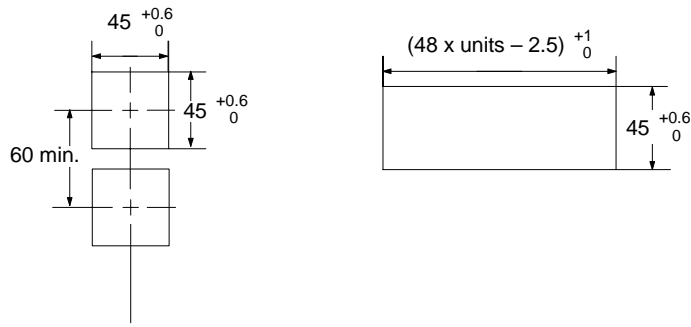

- Note**
1. All dimensions shown are in millimeters.
  2. Side-by-side close mounting is not possible for E5CJs equipped with the Watertight Cover (sold separately).

## Terminal Covers

**E53-COV02**

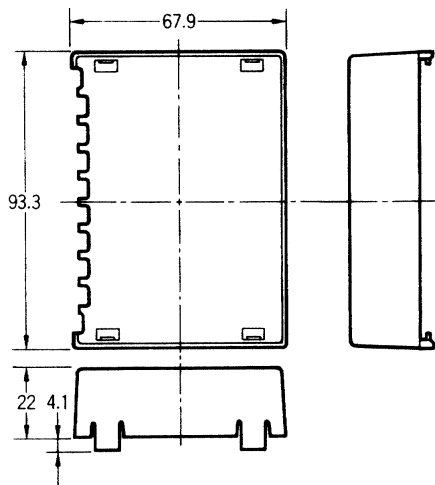

**E5AJ with Terminal Cover**

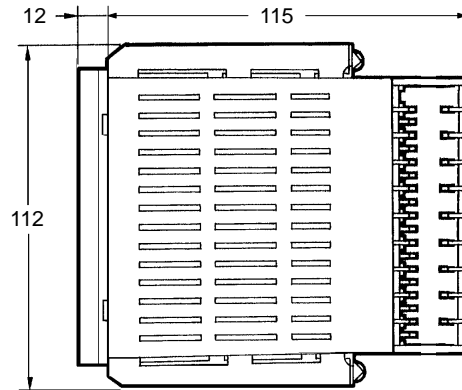

**E53-COV04**

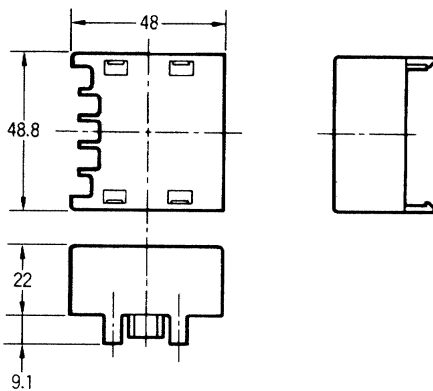

**E5CJ with Terminal Cover**

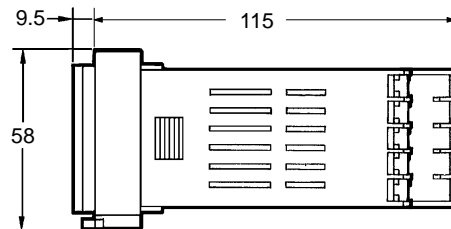



E53-COV03

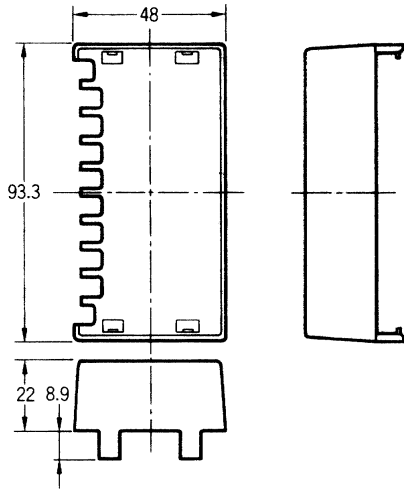

E5EJ with Terminal Cover

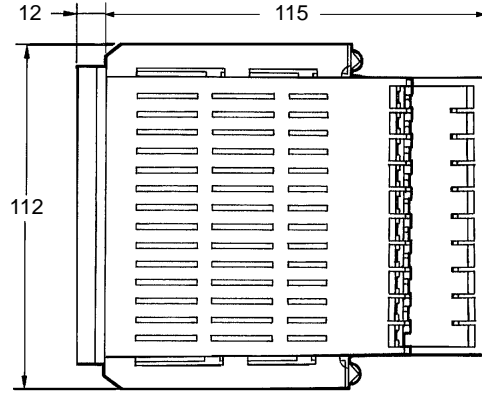

# Index

## A

- advanced PID
  - function, 2
  - setting, 14
  - setting with fuzzy self-tuning, 14
- alarm mode
  - changing, 22
  - setting. *See* settings
  - standby sequence. *See* settings
- auto-tuning
  - force-ending, 64
  - parameters, 64
  - preventing, 64
  - starting, 64
- automatic return of display mode. *See* engineering level

## C

- communications function, specifications, 7
- control period, setting range, 24
- CT. *See* current transformer
- current transformer
  - specifications, table, 6
  - wiring, 51
- cycling. *See* hunting

## D

- derivative time range, 25
- dimensions, 65, 66, 67
- display levels
  - level 1, 23
  - parameters, 22, 23
- displays
  - engineering level, 19
  - levels, 19
- disturbance tuning
  - conditions, 29
  - measuring external disturbance response waveform, 29
  - measuring set point response waveform, 29
  - startup conditions, 29
- DT. *See* disturbance tuning

## E

- engineering level
  - alarm hysteresis, 60
  - automatic return of display mode, 60
  - communications, 59
  - data bit length, 59
  - input shift display, 60
  - parameters, 19
  - parameters table, 56
  - parity check, 59
  - PID control type, 59
  - selecting temperature display, 59
  - settings, 56
  - stable range, 59
  - standby sequence reset, 60
  - stop bit, 59
- event input 2, 33
  - selecting, 61
- event input function, 2
  - parameters, 24
  - selecting RUN/STOP, 46
  - selecting set point, 46
  - signal input method, 47
- external disturbance, definition, 32

## F

- features, 2
- front panel, features, 18
- functions
  - control mode, 14
  - level setting, 14
  - output operation, 14
  - selector settings, 14
- fuzzy self-tuning
  - features, 28
  - function, 2

## H

- heater burnout
  - detection, 50
  - procedures, 50
- heater burnout alarm
  - current value, 24
  - determining value, 51
  - operating characteristics, 7
  - parameters, 24
  - setting examples, 52
  - setting value, 24
- HT. *See* hunting tuning
- hunting, definition, 32
- hunting tuning, startup conditions, 30
- hysteresis, setting range, 24

## I

installation  
  mounting, 36  
  precautions, 36

integral time range, 25

interference, definition, 33

internal switches, sensor type and control mode, 10

## K–M

key protection switch, setting, 15

manual reset value, 25

models, 2  
  Communications Boards, 4  
  communications function, limitations, 3, 4  
  standard, 3

mounting. *See* installation

mounting holes, 65, 66, 67

## N–O

nomenclature, 18

output unit  
  life expectancy, 7  
  npn type, 11  
  pnp type, 11  
  selecting, 10  
  specifications, table, 6  
  types and models, 2

output value, setting range, 24

## P

parameters  
  engineering level, 19  
  levels, 19  
  setting, 19  
  tables, 20

PID, setting constants, 32

proportional band range, 25

## R

return time, 60

RUN, selection, 46

## S

self-diagnostic function, 42

set point  
  *See also* event input function  
  adjusting changeable range, 60  
  setting type, 22

settings  
  advanced PID control, 14  
  alarm mode selection, 13  
  functions. *See* functions  
  fuzzy self-tuning, 14  
  internal switches, 11, 12  
  key protection switch, 15  
  selecting input type, 12  
  selecting output unit, 10  
  sensor type and control mode, 10

specifications  
  general, table, 5  
  operating characteristics, table, 6  
  output unit, table, 6

SRT. *See* step response tuning

stability judgement time, 32

stable range, 32

stable value, 32

standby sequence, resetting. *See* engineering level

startup, 33

step response tuning  
  *See also* SRT  
  operating conditions, 28  
  PID constant refreshing conditions, 29  
  startup conditions, 28  
  step controlled amount, 29

STOP, selection, 46

stop bit, changing length. *See* engineering level

## T

terminal arrangement, 38

Terminal Covers, 67

troubleshooting, 30  
  controller and sensor error, 43  
  table, 42

## W

watertight cover, 2

wiring  
  current transformer, 51  
  precautions, 37  
  terminal arrangement, 38, 39  
  using solder-dipped leads, 37  
  using solderless terminals, 37

## Revision History

# E5□J Temperature Controller

## Operation Manual

A manual revision code appears as a suffix to the catalog number on the front cover of the manual.

Cat. No. WZ103-E3-1

↑  
Revision  
code

The following table outlines the changes made to the manual during each revision. Page numbers refer to the previous version for manuals designated as E1 revisions.

Revision code	Date	Revised content
Z103-E1-1	November 1993	Original production
Z103-E1-1A	January 1994	<p><b>Page 20:</b> Hysteresis row in the table corrected. Note added.</p> <p><b>Page 21:</b> Proportional band row in the table corrected. Note added.</p> <p><b>Page 23:</b> Proportional band setting in the diagram corrected.</p> <p><b>Page 29:</b> Stable range in both diagrams corrected. Note added.</p> <p><b>Pages 30, 32:</b> Stable range in top diagram corrected.</p> <p><b>Page 51:</b> "Heater current value level 1" corrected to "Heater burnout value" in the equation.</p> <p><b>Page 56:</b> Stable range, alarm hysteresis 1, alarm hysteresis 2, and set point lower limit value rows in the table corrected.</p> <p><b>Page 57:</b> Note added.</p>
Z103-E1-2	March 1994	Major revision. Most of the pages have been changed or revised.
Z103-E1-3	June 1995	<p><i>Section 10 Auto-tuning</i> added.</p> <p><b>Page 2:</b> <i>Output Units</i> corrected.</p> <p><b>Page 4:</b> Note 1 corrected.</p> <p><b>Page 6:</b> Models added to the Output Units table.</p> <p><b>Page 10:</b> Models added to the Output Units table and second sentence after the table corrected.</p> <p><b>Page 28:</b> First note on the page corrected.</p> <p><b>Page 38:</b> The polarities for RS-485 in <i>E5AJ/E5EJ with Communications Function</i>.</p>
Z103-E1-4	November 1996	<p><b>Page 2:</b> Auto-tuning added to <i>1-1 Features</i>.</p> <p><b>Page 5:</b> Auto-tuning added to <i>Control mode</i> in the table.</p> <p><b>Page 7:</b> <i>EMC</i> and <i>Approved standards</i> added to the top table and <i>Enclosure ratings</i> changed. Notes added also.</p> <p><b>Page 38:</b> "+" added to terminals 20 and 19 and "-" added to terminal 17 in the E5AJ/E5EJ Standard Model terminal arrangement.</p> <p><b>Page 39:</b> "+" added to terminal 17 and "-" added to terminal 16 in the E5BJ terminal arrangement. "+" added to terminal 14 and "-" added to terminal 13 in the E5CJ Standard Model terminal arrangement.</p> <p><b>Pages 65 to 68:</b> Terminal Covers and their dimensions added.</p>

---

## *Revision History*

---

<b>Revision code</b>	<b>Date</b>	<b>Revised content</b>
Z103-E1-5	February 1998	<b>Page 4:</b> Supply voltage and power consumption specifications changed. <b>Page 19:</b> Thermac E5□J information added to the beginning of <i>3-2 Setting Flowchart</i> . <b>Pages 38, 39:</b> Terminal arrangement diagrams changed. <b>Page 56:</b> Information added to <i>9-1 Engineering Level</i> .
Z103-E3-1	March 1998	All references to model E5BJ removed. <b>Pages 38,39:</b> Corrected power consumption in terminal arrangement drawings (based on revision E1-5); kept terminal arrangement drawings the same as revision E1-4.