

CGA3E2NP01H100D080AA

TDK Item Description : CGA3E2NP01H100DT****



Equivalent C1608NP01H100D for Automotive

Application & Main Feature

Automotive Grade (High Temperature Application)

Series

CGA3(1608) [EIA CC0603]

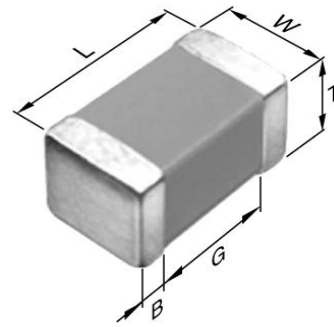

Dimensions

L 1.60mm +/-0.1mm
W 0.80mm +/-0.1mm
T 0.80mm +/-0.1mm
B 0.20mm Min.
G 0.30mm Min.

Temperature Characteristic

NP0 (-55 to 150 degC 0+/-30ppm/degC)

Rated Voltage

1H (50Vdc)

Capacitance

10pF

Capacitance Tolerance

D (+/-0.5pF)

Q Factor

600 Min.

Insulation Resistance

10Gohm Min.

AEC-Q200

Yes

|Z|, ESR vs. Freq. Characteristics

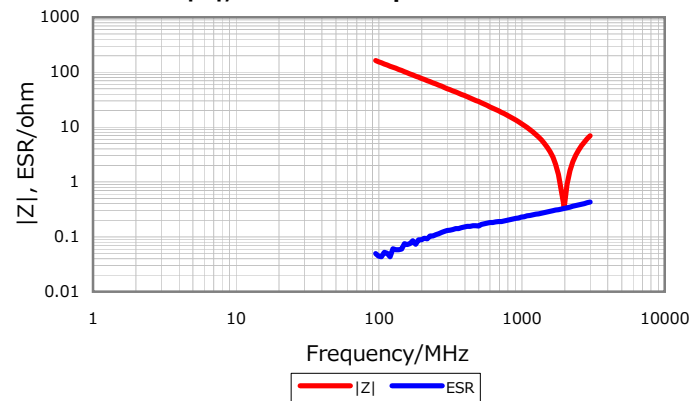

DC Bias Characteristic

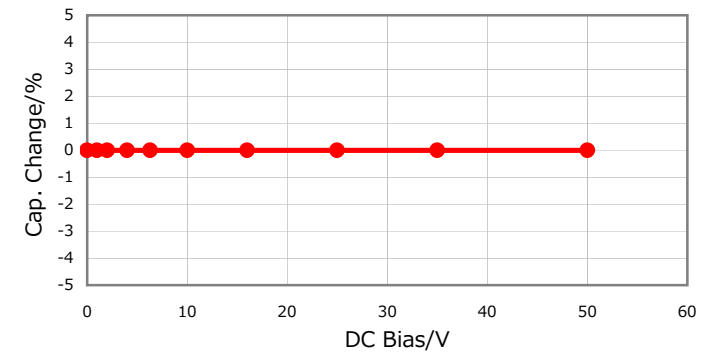

Cap. vs. Freq. Characteristic

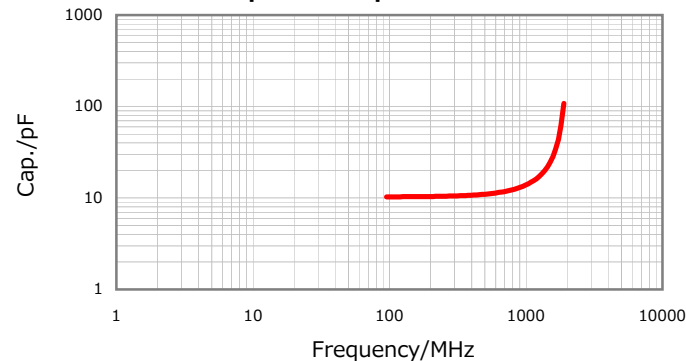

Temperature Characteristics

