



Is Now Part of



**ON Semiconductor®**

To learn more about ON Semiconductor, please visit our website at  
[www.onsemi.com](http://www.onsemi.com)

ON Semiconductor and the ON Semiconductor logo are trademarks of Semiconductor Components Industries, LLC dba ON Semiconductor or its subsidiaries in the United States and/or other countries. ON Semiconductor owns the rights to a number of patents, trademarks, copyrights, trade secrets, and other intellectual property. A listing of ON Semiconductor's product/patent coverage may be accessed at [www.onsemi.com/site/pdf/Patent-Marking.pdf](http://www.onsemi.com/site/pdf/Patent-Marking.pdf). ON Semiconductor reserves the right to make changes without further notice to any products herein. ON Semiconductor makes no warranty, representation or guarantee regarding the suitability of its products for any particular purpose, nor does ON Semiconductor assume any liability arising out of the application or use of any product or circuit, and specifically disclaims any and all liability, including without limitation special, consequential or incidental damages. Buyer is responsible for its products and applications using ON Semiconductor products, including compliance with all laws, regulations and safety requirements or standards, regardless of any support or applications information provided by ON Semiconductor. "Typical" parameters which may be provided in ON Semiconductor data sheets and/or specifications can and do vary in different applications and actual performance may vary over time. All operating parameters, including "Typicals" must be validated for each customer application by customer's technical experts. ON Semiconductor does not convey any license under its patent rights nor the rights of others. ON Semiconductor products are not designed, intended, or authorized for use as a critical component in life support systems or any FDA Class 3 medical devices or medical devices with a same or similar classification in a foreign jurisdiction or any devices intended for implantation in the human body. Should Buyer purchase or use ON Semiconductor products for any such unintended or unauthorized application, Buyer shall indemnify and hold ON Semiconductor and its officers, employees, subsidiaries, affiliates, and distributors harmless against all claims, costs, damages, and expenses, and reasonable attorney fees arising out of, directly or indirectly, any claim of personal injury or death associated with such unintended or unauthorized use, even if such claim alleges that ON Semiconductor was negligent regarding the design or manufacture of the part. ON Semiconductor is an Equal Opportunity/Affirmative Action Employer. This literature is subject to all applicable copyright laws and is not for resale in any manner.



August 2016

# FDP12N50NZ / FDPF12N50NZ

## N-Channel UniFET™ II MOSFET

500 V, 11.5 A, 520 mΩ

### Features

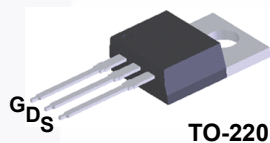
- $R_{DS(on)} = 460 \text{ m}\Omega$  (Typ.) @  $V_{GS} = 10 \text{ V}$ ,  $I_D = 5.75 \text{ A}$
- Low Gate Charge (Typ. 23 nC)
- Low  $C_{rss}$  (Typ. 14 pF)
- 100% Avalanche Tested
- ESD Improved Capability
- RoHS Compliant

### Applications

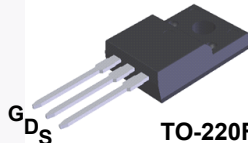
- LCD/LED/PDP TV
- Lighting
- Uninterruptible Power Supply

### Description

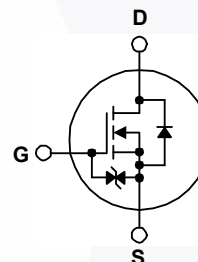
UniFET™ II MOSFET is Fairchild Semiconductor's high voltage MOSFET family based on advanced planar stripe and DMOS technology. This advanced MOSFET family has the smallest on-state resistance among the planar MOSFET, and also provides superior switching performance and higher avalanche energy strength. In addition, internal gate-source ESD diode allows UniFET II MOSFET to withstand over 2kV HBM surge stress. This device family is suitable for switching power converter applications such as power factor correction (PFC), flat panel display (FPD) TV power, ATX and electronic lamp ballasts.



TO-220



TO-220F



### MOSFET Maximum Ratings $T_C = 25^\circ\text{C}$ unless otherwise noted.

Symbol	Parameter	FDP12N50NZ	FDPF12N50NZ	Unit
$V_{DSS}$	Drain to Source Voltage	500		V
$V_{GSS}$	Gate to Source Voltage	$\pm 25$		V
$I_D$	Drain Current	- Continuous ( $T_C = 25^\circ\text{C}$ )	11.5	11.5*
		- Continuous ( $T_C = 100^\circ\text{C}$ )	6.9	6.9*
$I_{DM}$	Drain Current	- Pulsed (Note 1)	46	46*
$E_{AS}$	Single Pulsed Avalanche Energy (Note 2)	560		mJ
$I_{AR}$	Avalanche Current (Note 1)	11.5		A
$E_{AR}$	Repetitive Avalanche Energy (Note 1)	17		mJ
dv/dt	MOSFET dv/dt Ruggedness	20		V/ns
	Peak Diode Recovery dv/dt (Note 3)	10		V/ns
$P_D$	Power Dissipation	( $T_C = 25^\circ\text{C}$ )	170	42
		- Derate above $25^\circ\text{C}$	1.37	0.33
$T_J, T_{STG}$	Operating and Storage Temperature Range	-55 to +150		$^\circ\text{C}$
$T_L$	Maximum Lead Temperature for Soldering, 1/8" from Case for 5 Seconds	300		$^\circ\text{C}$

\*Drain current limited by maximum junction temperature

### Thermal Characteristics

Symbol	Parameter	FDP12N50NZ	FDPF12N50NZ	Unit
$R_{\theta JC}$	Thermal Resistance, Junction to Case, Max.	0.73	3.0	$^\circ\text{C}/\text{W}$
$R_{\theta JA}$	Thermal Resistance, Junction to Ambient, Max.	62.5	62.5	

## Package Marking and Ordering Information

Device Marking	Device	Package	Reel Size	Tape Width	Quantity
FDP12N50NZ	FDP12N50NZ	TO-220	Tube	N/A	50 units
FDPF12N50NZ	FDPF12N50NZ	TO-220F	Tube	N/A	50 units

## Electrical Characteristics $T_C = 25^\circ\text{C}$ unless otherwise noted.

Symbol	Parameter	Test Conditions	Min.	Typ.	Max.	Unit
--------	-----------	-----------------	------	------	------	------

### Off Characteristics

$BV_{DSS}$	Drain to Source Breakdown Voltage	$I_D = 250\mu\text{A}$ , $V_{GS} = 0\text{V}$ , $T_J = 25^\circ\text{C}$	500	-	-	V
$\Delta BV_{DSS} / \Delta T_J$	Breakdown Voltage Temperature Coefficient	$I_D = 250\mu\text{A}$ , Referenced to $25^\circ\text{C}$	-	0.5	-	$\text{V}/^\circ\text{C}$
$I_{DSS}$	Zero Gate Voltage Drain Current	$V_{DS} = 500\text{V}$ , $V_{GS} = 0\text{V}$ $V_{DS} = 400\text{V}$ , $T_C = 125^\circ\text{C}$	-	-	1 10	$\mu\text{A}$
$I_{GSS}$	Gate to Body Leakage Current	$V_{GS} = \pm 25\text{V}$ , $V_{DS} = 0\text{V}$	-	-	$\pm 10$	$\mu\text{A}$

### On Characteristics

$V_{GS(th)}$	Gate Threshold Voltage	$V_{GS} = V_{DS}$ , $I_D = 250\mu\text{A}$	3.0	-	5.0	V
$R_{DS(on)}$	Static Drain to Source On Resistance	$V_{GS} = 10\text{V}$ , $I_D = 5.75\text{A}$	-	0.46	0.52	$\Omega$
$g_{FS}$	Forward Transconductance	$V_{DS} = 20\text{V}$ , $I_D = 5.75\text{A}$	-	12	-	S

### Dynamic Characteristics

$C_{iss}$	Input Capacitance	$V_{DS} = 25\text{V}$ , $V_{GS} = 0\text{V}$ $f = 1\text{MHz}$	-	945	1235	pF
$C_{oss}$	Output Capacitance		-	155	205	pF
$C_{riss}$	Reverse Transfer Capacitance		-	14	20	pF
$Q_g$	Total Gate Charge at 10V	$V_{DS} = 400\text{V}$ , $I_D = 11.5\text{A}$ $V_{GS} = 10\text{V}$	-	23	30	nC
$Q_{gs}$	Gate to Source Gate Charge		-	5.5	-	nC
$Q_{gd}$	Gate to Drain "Miller" Charge		(Note 4)	-	9.6	-

### Switching Characteristics

$t_{d(on)}$	Turn-On Delay Time	$V_{DD} = 250\text{V}$ , $I_D = 11.5\text{A}$ $R_G = 25\Omega$	-	20	50	ns
$t_r$	Turn-On Rise Time		-	50	110	ns
$t_{d(off)}$	Turn-Off Delay Time		-	60	130	ns
$t_f$	Turn-Off Fall Time		(Note 4)	-	45	100

### Drain-Source Diode Characteristics

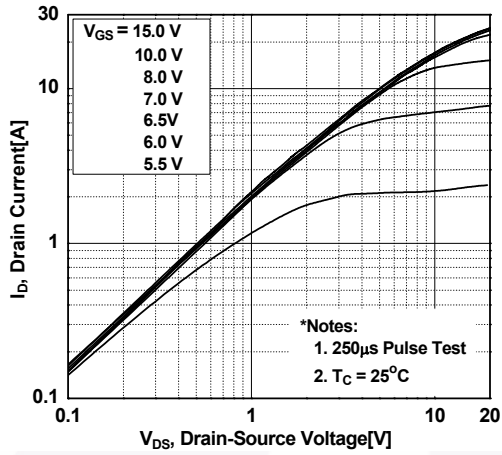
$I_S$	Maximum Continuous Drain to Source Diode Forward Current	-	-	11.5	A	
$I_{SM}$	Maximum Pulsed Drain to Source Diode Forward Current	-	-	46	A	
$V_{SD}$	Drain to Source Diode Forward Voltage	$V_{GS} = 0\text{V}$ , $I_{SD} = 11.5\text{A}$	-	-	1.4	V
$t_{rr}$	Reverse Recovery Time	$V_{GS} = 0\text{V}$ , $I_{SD} = 11.5\text{A}$ $di_F/dt = 100\text{A}/\mu\text{s}$	-	315	-	ns
$Q_{rr}$	Reverse Recovery Charge		-	2.0	-	$\mu\text{C}$

#### Notes:

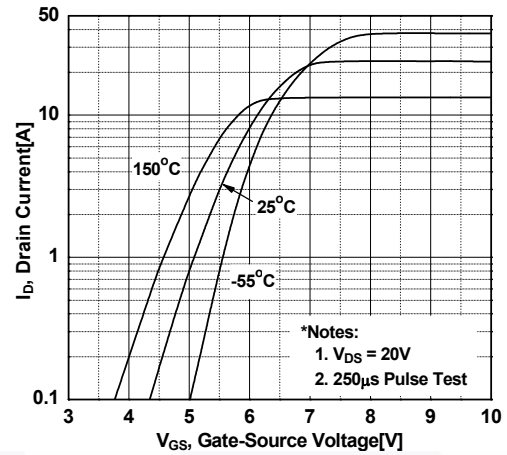
1. Repetitive Rating: Pulse width limited by maximum junction temperature
2.  $L = 8.5\text{mH}$ ,  $I_{AS} = 11.5\text{A}$ ,  $V_{DD} = 50\text{V}$ ,  $R_G = 25\Omega$ , Starting  $T_J = 25^\circ\text{C}$
3.  $I_{SD} \leq 11.5\text{A}$ ,  $di/dt \leq 200\text{A}/\mu\text{s}$ ,  $V_{DD} \leq BV_{DSS}$ , Starting  $T_J = 25^\circ\text{C}$
4. Essentially Independent of Operating Temperature Typical Characteristics

## Typical Characteristics

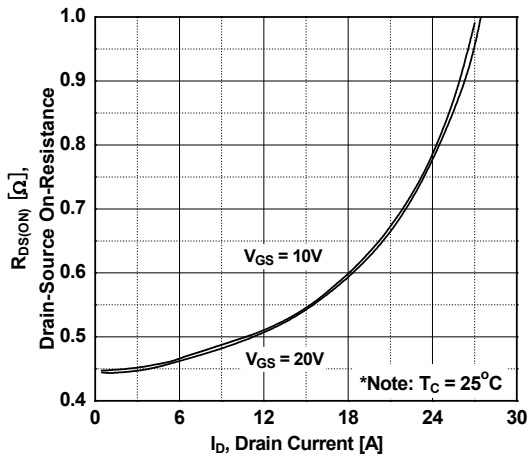
**Figure 1. On-Region Characteristics**



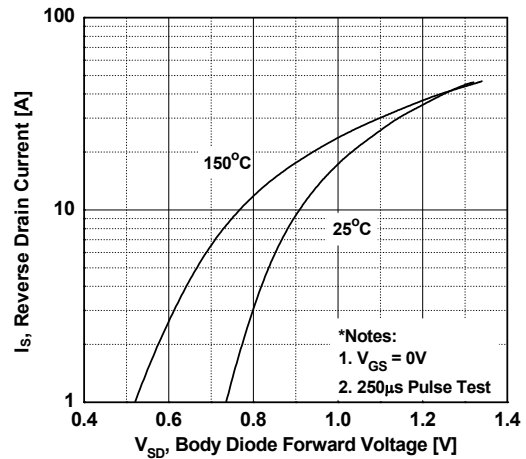
**Figure 2. Transfer Characteristics**



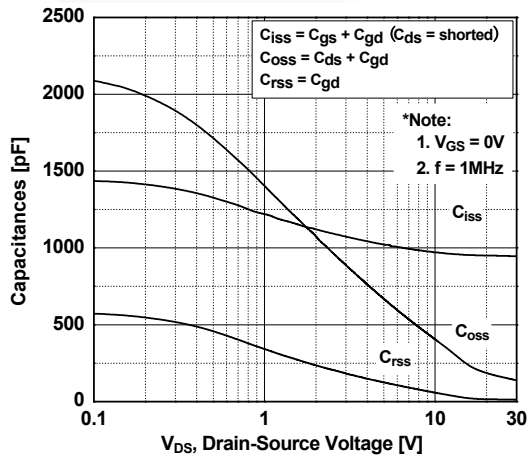
**Figure 3. On-Resistance Variation vs. Drain Current and Gate Voltage**



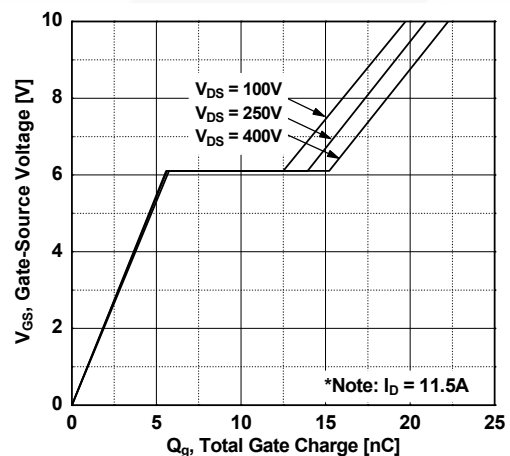
**Figure 4. Body Diode Forward Voltage Variation vs. Source Current and Temperature**



**Figure 5. Capacitance Characteristics**

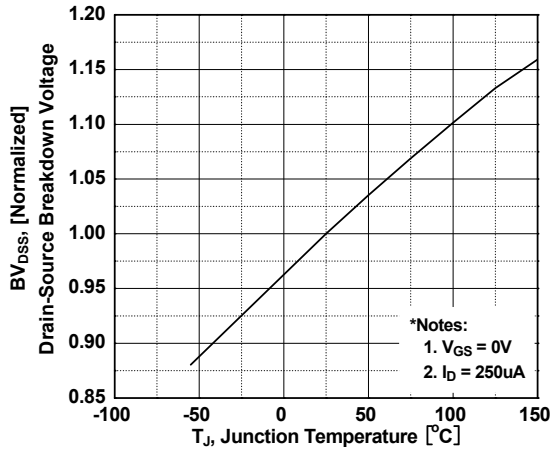


**Figure 6. Gate Charge Characteristics**

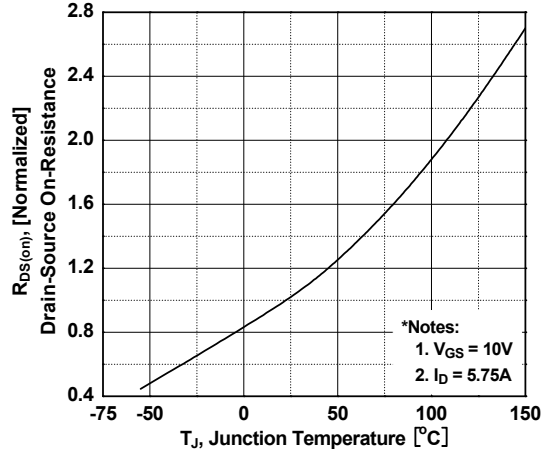


**Typical Characteristics** (Continued)

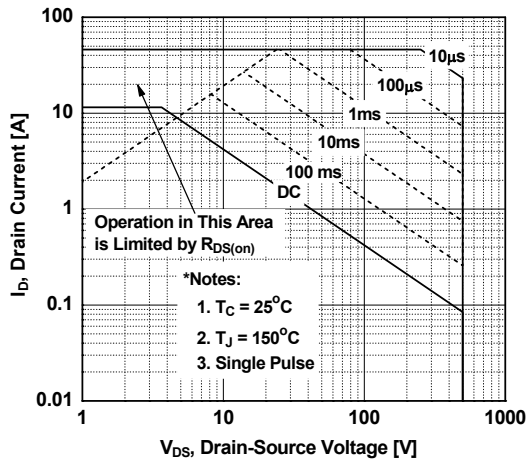
**Figure 7. Breakdown Voltage Variation vs. Temperature**



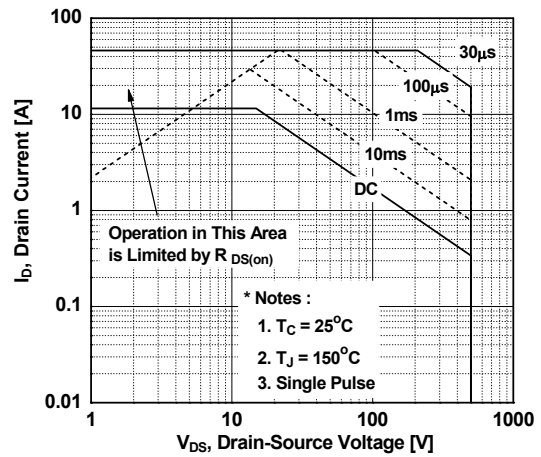
**Figure 8. On-Resistance Variation vs. Temperature**



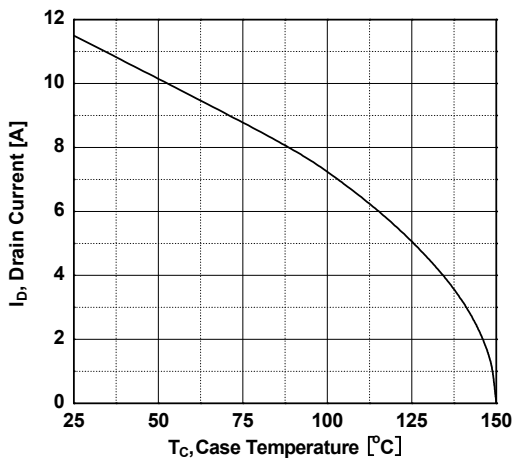
**Figure 9. Maximum Safe Operating Area - FDP12N50NZ**



**Figure 10. Maximum Safe Operating Area - FDP12N50NZ**



**Figure 11. Maximum Drain Current vs. Case Temperature**



Typical Characteristics (Continued)

Figure 12. Transient Thermal Response Curve - FDP12N50NZ

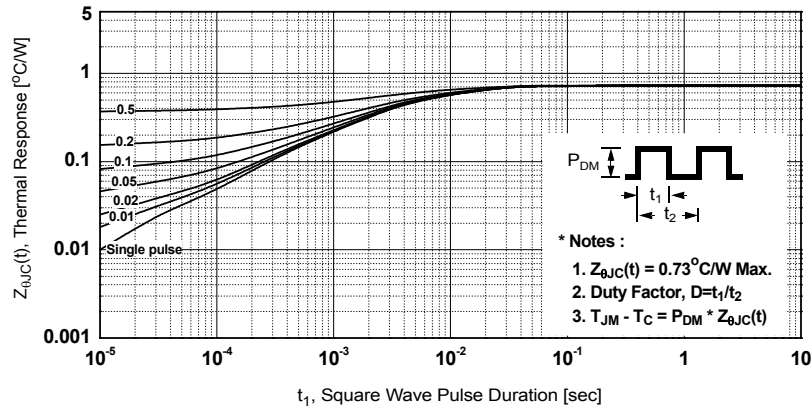
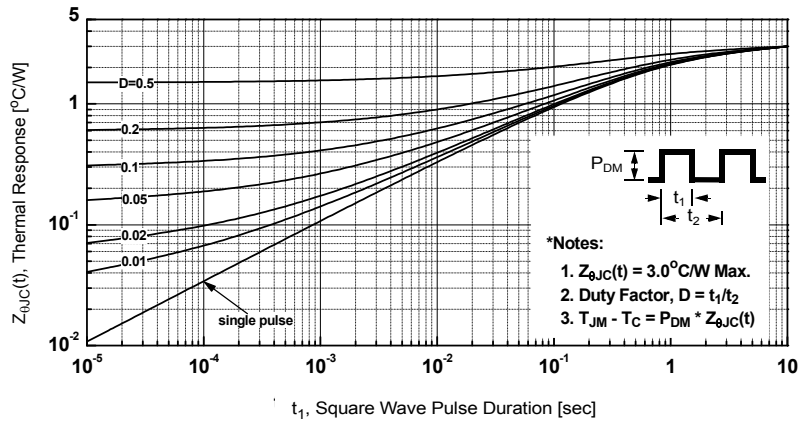
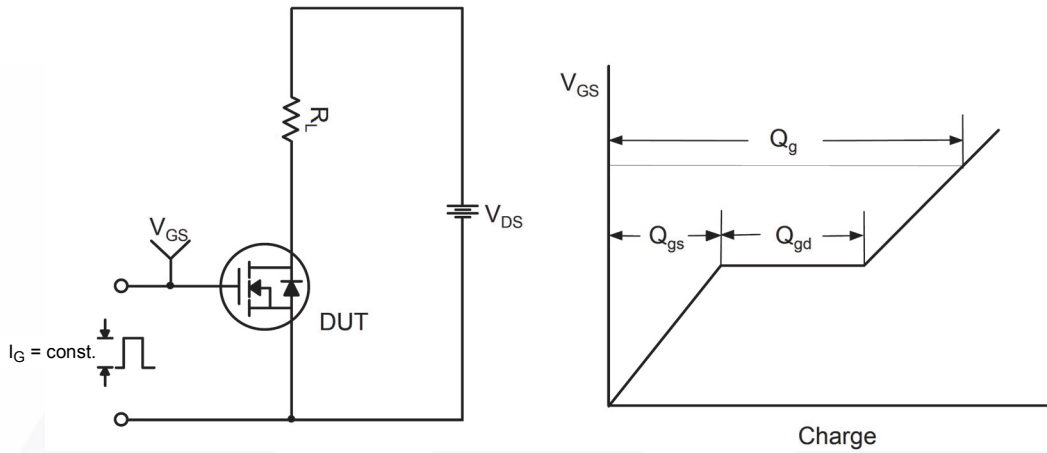


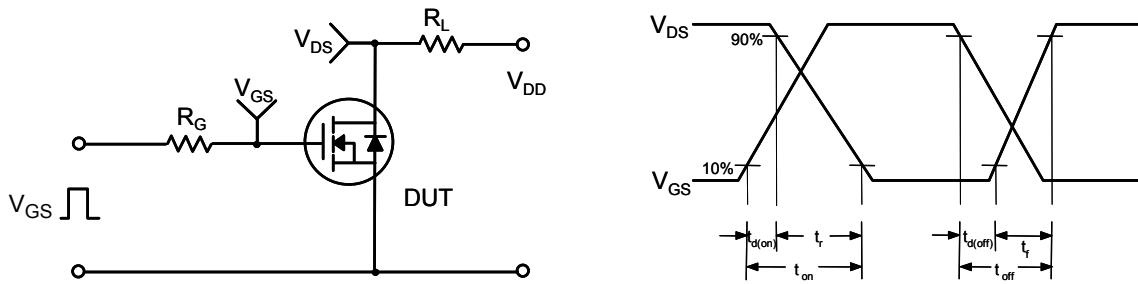
Figure 13. Transient Thermal Response Curve - FDPF12N50NZ



**Figure 14. Gate Charge Test Circuit & Waveform**



**Figure 15. Resistive Switching Test Circuit & Waveforms**



**Figure 16. Unclamped Inductive Switching Test Circuit & Waveforms**

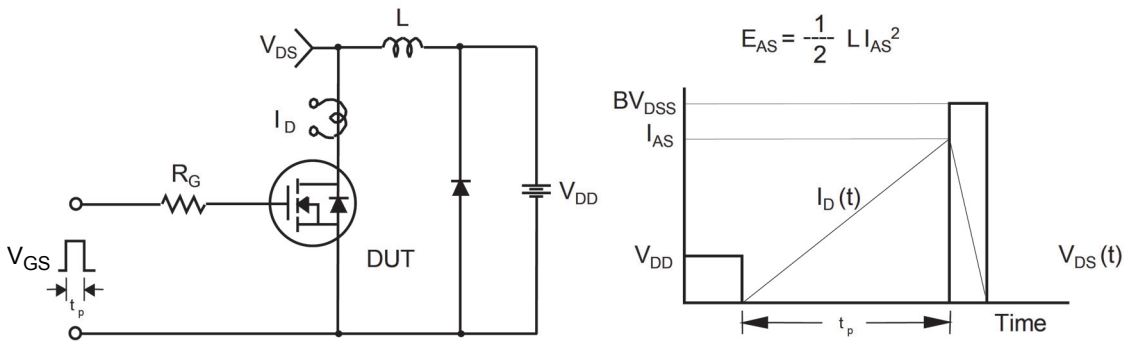
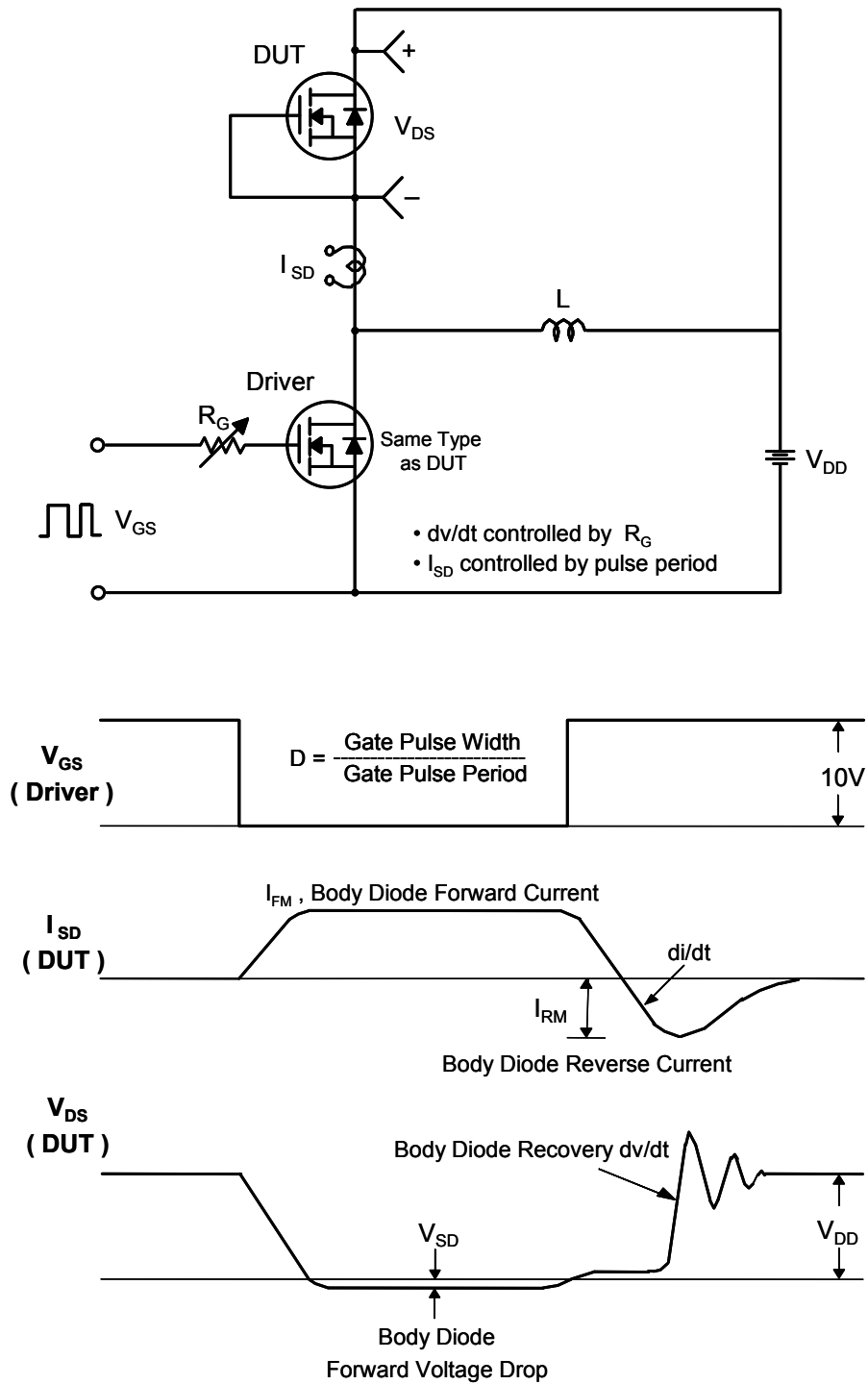


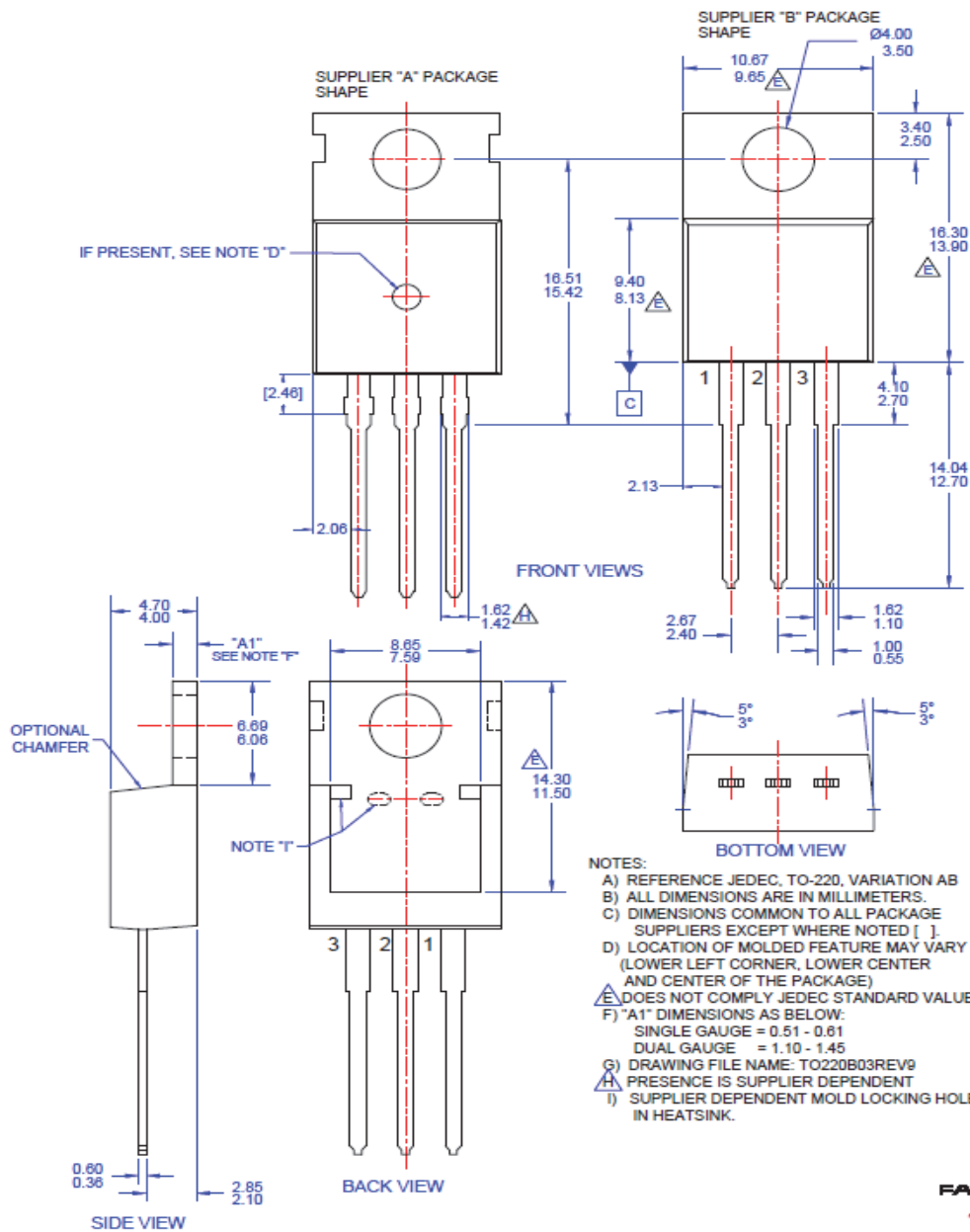
Figure 17. Peak Diode Recovery dv/dt Test Circuit & Waveforms





# Mechanical Dimensions

## TO-220 3L

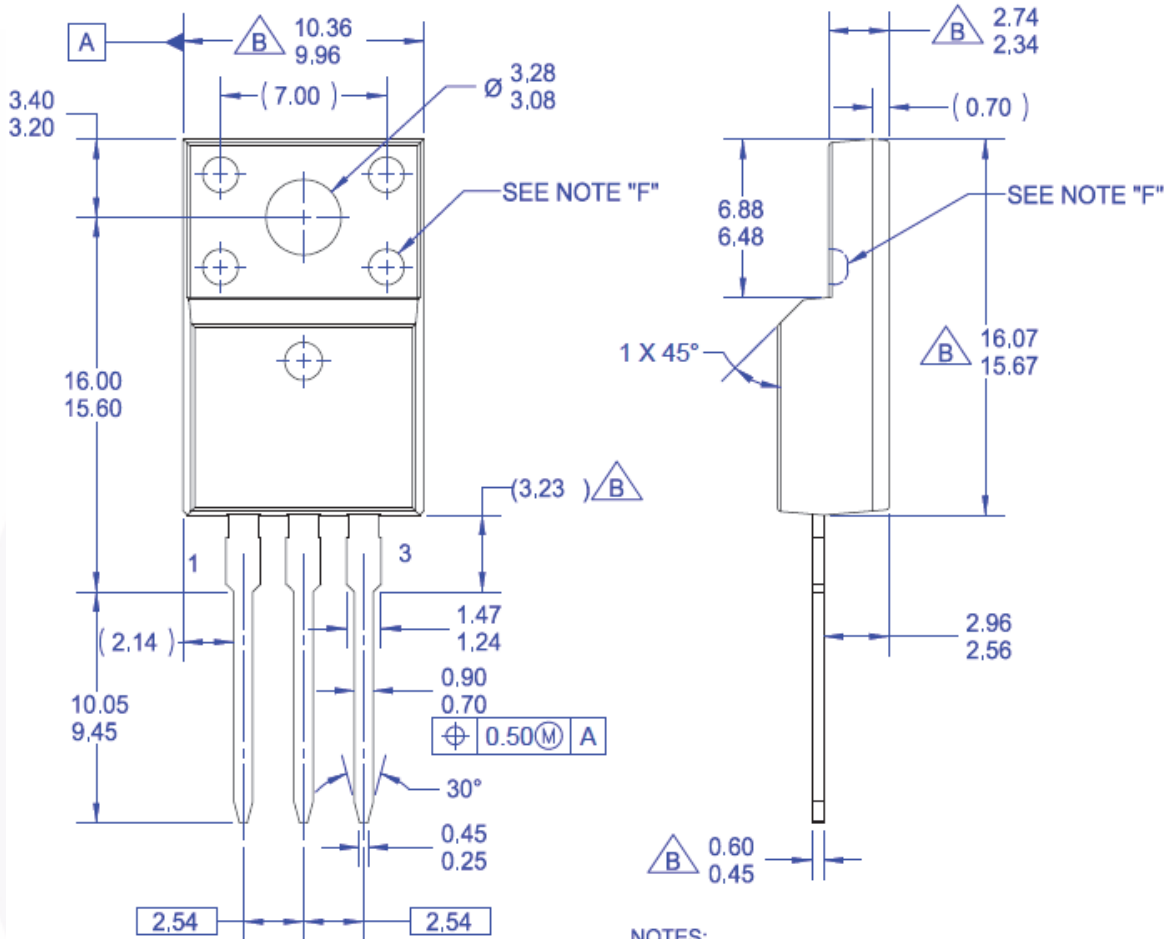


- NOTES:
- A) REFERENCE JEDEC, TO-220, VARIATION AB
  - B) ALL DIMENSIONS ARE IN MILLIMETERS.
  - C) DIMENSIONS COMMON TO ALL PACKAGE SUPPLIERS EXCEPT WHERE NOTED [ ].
  - D) LOCATION OF MOLDED FEATURE MAY VARY (LOWER LEFT CORNER, LOWER CENTER AND CENTER OF THE PACKAGE)
  - E) DOES NOT COMPLY JEDEC STANDARD VALUE.
  - F) "A1" DIMENSIONS AS BELOW:  
SINGLE GAUGE = 0.51 - 0.61  
DUAL GAUGE = 1.10 - 1.45
  - G) DRAWING FILE NAME: TO220B03REV9
  - H) PRESENCE IS SUPPLIER DEPENDENT
  - I) SUPPLIER DEPENDENT MOLD LOCKING HOLES IN HEATSINK.



## Mechanical Dimensions

### TO-220F 3L



#### NOTES:






- A. EXCEPT WHERE NOTED CONFORMS TO EIAJ SC91A.
- B. DOES NOT COMPLY EIAJ STD. VALUE.
- C. ALL DIMENSIONS ARE IN MILLIMETERS.
- D. DIMENSIONS ARE EXCLUSIVE OF BURRS, MOLD FLASH AND TIE BAR PROTRUSIONS.
- E. DIMENSION AND TOLERANCE AS PER ASME Y14.5-1994.
- F. OPTION 1 - WITH SUPPORT PIN HOLE.  
OPTION 2 - NO SUPPORT PIN HOLE.
- G. DRAWING FILE NAME: TO220M03REV4





**TRADEMARKS**

The following includes registered and unregistered trademarks and service marks, owned by Fairchild Semiconductor and/or its global subsidiaries, and is not intended to be an exhaustive list of all such trademarks.

- |   |   |   |   |
|---|---|---|---|
| AccuPower™  | F-PFS™  | OPTOPLANAR®   |   |
| AttitudeEngine™   | FRFET®  |  |   |
| Awinda®   | Global Power Resource™                          |   |   |
| AX-CAP®*  | GreenBridge™                                    | Power Supply WebDesigner™   |  |
| BitSiC™   | Green FPS™                                      | PowerTrench®  | TinyBoost®  |
| Build it Now™   | Green FPS™ e-Series™                            | PowerXS™  | TinyBuck®   |
| CorePLUS™   | Gmax™   | Programmable Active Droop™  | TinyCalc™   |
| CorePOWER™  | GTO™  | QFET®   | TinyLogic®  |
| CROSSVOLT™  | IntelliMAX™                                     | QS™   | TINYOPTO™   |
| CTL™  | ISOPLANAR™                                      | Quiet Series™   | TinyPower™  |
| Current Transfer Logic™   | Marking Small Speakers Sound Louder and Better™ | RapidConfigure™   | TinyPWM™  |
| DEUXPEED®   | MegaBuck™                                       |  | TinyWire™   |
| Dual Cool™  | MICROCOUPLER™                                   | Saving our world, 1mW/W/kW at a time™   | TransSiC™   |
| EcoSPARK®   | MicroFET™                                       | SignalWise™   | TriFault Detect™  |
| EfficientMax™   | MicroPak™                                       | SmartMax™   | TRUECURRENT®*   |
| ESBC™   | MicroPak2™                                      | SMART START™  | µSerDes™  |
|  | MillerDrive™                                    | Solutions for Your Success™   |  |
| Fairchild®  | MotionMax™                                      | SPM®  | UHC®  |
| Fairchild Semiconductor®  | MotionGrid®                                     | STEALTH™  | Ultra FRFET™  |
| FACT Quiet Series™  | MTI®  | SuperFET®   | UniFET™   |
| FACT®   | MTx®  | SuperSOT™-3   | VCX™  |
| FastvCore™  | MVN®  | SuperSOT™-6   | VisualMax™  |
| FETBench™   | mWSaver®  | SuperSOT™-8   | VoltagePlus™  |
| FPS™  | OptoHiT™  | SupreMOS®   | XS™   |
|   | OPTOLOGIC®                                      | SyncFET™  | Xsens™  |
|   |   | Sync-Lock™  | 仙童®   |

\*Trademarks of System General Corporation, used under license by Fairchild Semiconductor.

**DISCLAIMER**

FAIRCHILD SEMICONDUCTOR RESERVES THE RIGHT TO MAKE CHANGES WITHOUT FURTHER NOTICE TO ANY PRODUCTS HEREIN TO IMPROVE RELIABILITY, FUNCTION, OR DESIGN. TO OBTAIN THE LATEST, MOST UP-TO-DATE DATASHEET AND PRODUCT INFORMATION, VISIT OUR WEBSITE AT <http://www.fairchildsemi.com>. FAIRCHILD DOES NOT ASSUME ANY LIABILITY ARISING OUT OF THE APPLICATION OR USE OF ANY PRODUCT OR CIRCUIT DESCRIBED HEREIN; NEITHER DOES IT CONVEY ANY LICENSE UNDER ITS PATENT RIGHTS, NOR THE RIGHTS OF OTHERS. THESE SPECIFICATIONS DO NOT EXPAND THE TERMS OF FAIRCHILD'S WORLDWIDE TERMS AND CONDITIONS, SPECIFICALLY THE WARRANTY THEREIN, WHICH COVERS THESE PRODUCTS.

**AUTHORIZED USE**

Unless otherwise specified in this data sheet, this product is a standard commercial product and is not intended for use in applications that require extraordinary levels of quality and reliability. This product may not be used in the following applications, unless specifically approved in writing by a Fairchild officer: (1) automotive or other transportation, (2) military/aerospace, (3) any safety critical application – including life critical medical equipment – where the failure of the Fairchild product reasonably would be expected to result in personal injury, death or property damage. Customer's use of this product is subject to agreement of this Authorized Use policy. In the event of an unauthorized use of Fairchild's product, Fairchild accepts no liability in the event of product failure. In other respects, this product shall be subject to Fairchild's Worldwide Terms and Conditions of Sale, unless a separate agreement has been signed by both Parties.

**ANTI-COUNTERFEITING POLICY**

Fairchild Semiconductor Corporation's Anti-Counterfeiting Policy. Fairchild's Anti-Counterfeiting Policy is also stated on our external website, [www.fairchildsemi.com](http://www.fairchildsemi.com), under Terms of Use

Counterfeiting of semiconductor parts is a growing problem in the industry. All manufacturers of semiconductor products are experiencing counterfeiting of their parts. Customers who inadvertently purchase counterfeit parts experience many problems such as loss of brand reputation, substandard performance, failed applications, and increased cost of production and manufacturing delays. Fairchild is taking strong measures to protect ourselves and our customers from the proliferation of counterfeit parts. Fairchild strongly encourages customers to purchase Fairchild parts either directly from Fairchild or from Authorized Fairchild Distributors who are listed by country on our web page cited above. Products customers buy either from Fairchild directly or from Authorized Fairchild Distributors are genuine parts, have full traceability, meet Fairchild's quality standards for handling and storage and provide access to Fairchild's full range of up-to-date technical and product information. Fairchild and our Authorized Distributors will stand behind all warranties and will appropriately address and warranty issues that may arise. Fairchild will not provide any warranty coverage or other assistance for parts bought from Unauthorized Sources. Fairchild is committed to combat this global problem and encourage our customers to do their part in stopping this practice by buying direct or from authorized distributors.

**PRODUCT STATUS DEFINITIONS**

**Definition of Terms**

Datasheet Identification	Product Status	Definition
Advance Information	Formative / In Design	Datasheet contains the design specifications for product development. Specifications may change in any manner without notice.
Preliminary	First Production	Datasheet contains preliminary data; supplementary data will be published at a later date. Fairchild Semiconductor reserves the right to make changes at any time without notice to improve design.
No Identification Needed	Full Production	Datasheet contains final specifications. Fairchild Semiconductor reserves the right to make changes at any time without notice to improve the design.
Obsolete	Not In Production	Datasheet contains specifications on a product that is discontinued by Fairchild Semiconductor. The datasheet is for reference information only.

ON Semiconductor and  are trademarks of Semiconductor Components Industries, LLC dba ON Semiconductor or its subsidiaries in the United States and/or other countries. ON Semiconductor owns the rights to a number of patents, trademarks, copyrights, trade secrets, and other intellectual property. A listing of ON Semiconductor's product/patent coverage may be accessed at [www.onsemi.com/site/pdf/Patent-Marking.pdf](http://www.onsemi.com/site/pdf/Patent-Marking.pdf). ON Semiconductor reserves the right to make changes without further notice to any products herein. ON Semiconductor makes no warranty, representation or guarantee regarding the suitability of its products for any particular purpose, nor does ON Semiconductor assume any liability arising out of the application or use of any product or circuit, and specifically disclaims any and all liability, including without limitation special, consequential or incidental damages. Buyer is responsible for its products and applications using ON Semiconductor products, including compliance with all laws, regulations and safety requirements or standards, regardless of any support or applications information provided by ON Semiconductor. "Typical" parameters which may be provided in ON Semiconductor data sheets and/or specifications can and do vary in different applications and actual performance may vary over time. All operating parameters, including "Typicals" must be validated for each customer application by customer's technical experts. ON Semiconductor does not convey any license under its patent rights nor the rights of others. ON Semiconductor products are not designed, intended, or authorized for use as a critical component in life support systems or any FDA Class 3 medical devices or medical devices with a same or similar classification in a foreign jurisdiction or any devices intended for implantation in the human body. Should Buyer purchase or use ON Semiconductor products for any such unintended or unauthorized application, Buyer shall indemnify and hold ON Semiconductor and its officers, employees, subsidiaries, affiliates, and distributors harmless against all claims, costs, damages, and expenses, and reasonable attorney fees arising out of, directly or indirectly, any claim of personal injury or death associated with such unintended or unauthorized use, even if such claim alleges that ON Semiconductor was negligent regarding the design or manufacture of the part. ON Semiconductor is an Equal Opportunity/Affirmative Action Employer. This literature is subject to all applicable copyright laws and is not for resale in any manner.

## PUBLICATION ORDERING INFORMATION

### LITERATURE FULFILLMENT:

Literature Distribution Center for ON Semiconductor  
19521 E. 32nd Pkwy, Aurora, Colorado 80011 USA  
**Phone:** 303-675-2175 or 800-344-3860 Toll Free USA/Canada  
**Fax:** 303-675-2176 or 800-344-3867 Toll Free USA/Canada  
**Email:** [orderlit@onsemi.com](mailto:orderlit@onsemi.com)

**N. American Technical Support:** 800-282-9855 Toll Free  
USA/Canada  
**Europe, Middle East and Africa Technical Support:**  
Phone: 421 33 790 2910  
**Japan Customer Focus Center**  
Phone: 81-3-5817-1050

**ON Semiconductor Website:** [www.onsemi.com](http://www.onsemi.com)  
**Order Literature:** <http://www.onsemi.com/orderlit>  
For additional information, please contact your local  
Sales Representative