

Features

- Low gate charge
- 100% avalanche tested
- Improved dv/dt capability
- RoHS compliant
- Halogen free package
- JEDEC Qualification
- Improved ESD performance

N-channel MOSFET

BV_{DSS}	I_D	$R_{DS(on)}$
600V	4.2A	< 2.1 Ω

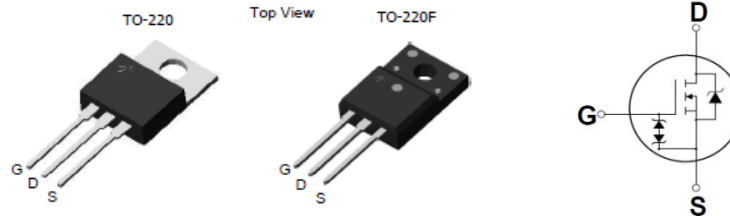

Device	Package	Marking	Remark
GP2M005A060HG	TO-220	GP2M005A060HG	RoHS
GP2M005A060FG	TO-220F	GP2M005A060FG	RoHS

Absolute Maximum Ratings

Parameter	Symbol	GP2M005A060HG	GP2M005A060FG	Unit
Drain-Source Voltage	V_{DSS}	600		V
Gate-Source Voltage	V_{GS}	± 30		V
Continuous Drain Current	$T_C = 25\text{ }^\circ\text{C}$	4.2	4.2 *	A
	$T_C = 100\text{ }^\circ\text{C}$	2.71	2.71 *	A
Pulsed Drain Current (Note 1)	I_{DM}	16.8	16.8 *	A
Single Pulse Avalanche Energy (Note 2)	E_{AS}	217		mJ
Repetitive Avalanche Current (Note 1)	I_{AR}	4.2		A
Repetitive Avalanche Energy (Note 1)	E_{AR}	9.84		mJ
Power Dissipation	$T_C = 25\text{ }^\circ\text{C}$	98.4	32.8	W
	Derate above 25 $^\circ\text{C}$	0.787	0.263	W/ $^\circ\text{C}$
Peak Diode Recovery dv/dt (Note 3)	dv/dt	4.5		V/ns
Operating Junction and Storage Temperature Range	T_J, T_{STG}	-55~150		$^\circ\text{C}$
Maximum lead temperature for soldering purposes, 1/8" from case for 5 seconds	T_L	300		$^\circ\text{C}$

* Limited only by maximum junction temperature

Thermal Characteristics

Parameter	Symbol	GP2M005A060HG	GP2M005A060FG	Unit
Maximum Thermal resistance, Junction-to-Case	$R_{\theta JC}$	1.27	3.8	$^\circ\text{C/W}$
Maximum Thermal resistance, Junction-to-Ambient	$R_{\theta JA}$	62.5	62.5	$^\circ\text{C/W}$

Electrical Characteristics : $T_C=25^\circ\text{C}$, unless otherwise noted

Parameter	Symbol	Test condition	Min	Typ	Max	Units
OFF						
Drain-Source Breakdown Voltage	BV_{DSS}	$V_{GS} = 0\text{ V}, I_D = 250\ \mu\text{A}$	600	--	--	V
Zero Gate Voltage Drain Current	I_{DSS}	$V_{DS} = 600\text{ V}, V_{GS} = 0\text{ V}$	--	--	1	μA
		$V_{DS} = 480\text{ V}, T_C = 125^\circ\text{C}$	--	--	10	μA
Forward Gate-Source Leakage Current	I_{GSSF}	$V_{GS} = 30\text{ V}, V_{DS} = 0\text{ V}$	--	--	100	μA
Reverse Gate-Source Leakage Current	I_{GSSR}	$V_{GS} = -30\text{ V}, V_{DS} = 0\text{ V}$	--	--	-100	μA
ON						
Gate Threshold Voltage	$V_{GS(th)}$	$V_{DS} = V_{GS}, I_D = 250\ \mu\text{A}$	3	--	5	V
Drain-Source On-Resistance	$R_{DS(on)}$	$V_{GS} = 10\text{ V}, I_D = 2.1\text{ A}$	--	1.7	2.1	Ω
Forward Transconductance ^(Note 4)	g_{FS}	$V_{DS} = 30\text{ V}, I_D = 2.1\text{ A}$	--	5	--	S
DYNAMIC						
Input Capacitance	C_{iss}	$V_{DS} = 25\text{ V}, V_{GS} = 0\text{ V},$ $f = 1.0\text{ MHz}$	--	658	--	pF
Output Capacitance	C_{oss}		--	72	--	pF
Reverse Transfer Capacitance	C_{rss}		--	9	--	pF
SWITCHING						
Turn-On Delay Time ^(Note 4,5)	$t_{d(on)}$	$V_{DD} = 300\text{ V}, I_D = 4.2\text{ A},$ $R_G = 25\ \Omega, V_{GS} = 10\text{ V}$	--	19	--	ns
Turn-On Rise Time ^(Note 4,5)	t_r		--	25	--	ns
Turn-Off Delay Time ^(Note 4,5)	$t_{d(off)}$		--	34	--	ns
Turn-Off Fall Time ^(Note 4,5)	t_f		--	19	--	ns
Total Gate Charge ^(Note 4,5)	Q_g	$V_{DS} = 480\text{ V}, I_D = 4.2\text{ A},$ $V_{GS} = 10\text{ V}$	--	14	--	nC
Gate-Source Charge ^(Note 4,5)	Q_{gs}		--	3	--	nC
Gate-Drain Charge ^(Note 4,5)	Q_{gd}		--	7	--	nC
SOURCE DRAIN DIODE						
Maximum Continuous Drain-Source Diode Forward Current	I_S	----	--	--	4.2	A
Maximum Pulsed Drain-Source Diode Forward Current	I_{SM}	----	--	--	16.8	A
Drain-Source Diode Forward Voltage	V_{SD}	$V_{GS} = 0\text{ V}, I_S = 4.2\text{ A}$	--	--	1.5	V
Reverse Recovery Time ^(Note 4)	t_{rr}	$V_{GS} = 0\text{ V}, I_S = 4.2\text{ A}$ $di_F / dt = 100\text{ A}/\mu\text{s}$	--	283	--	ns
Reverse Recovery Charge ^(Note 4)	Q_{rr}		--	1.6	--	μC

Note :

1. Repeated rating : Pulse width limited by safe operating area
2. $L=22.6\text{mH}, I_{AS} = 4.2\text{A}, V_{DD} = 50\text{V}, R_G = 25\ \Omega,$ Starting $T_J = 25^\circ\text{C}$
3. $I_{SD} \leq 4.2\text{A}, di/dt \leq 200\text{A}/\mu\text{s}, V_{DD} \leq BV_{DS},$ Starting $T_J = 25^\circ\text{C}$
4. Pulse Test : Pulse width $\leq 300\ \mu\text{s},$ Duty Cycle $\leq 2\%$
5. Essentially Independent of Operating Temperature Typical Characteristics

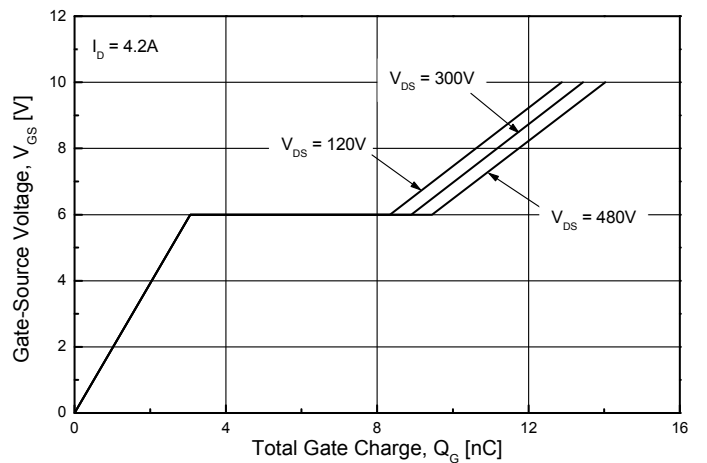
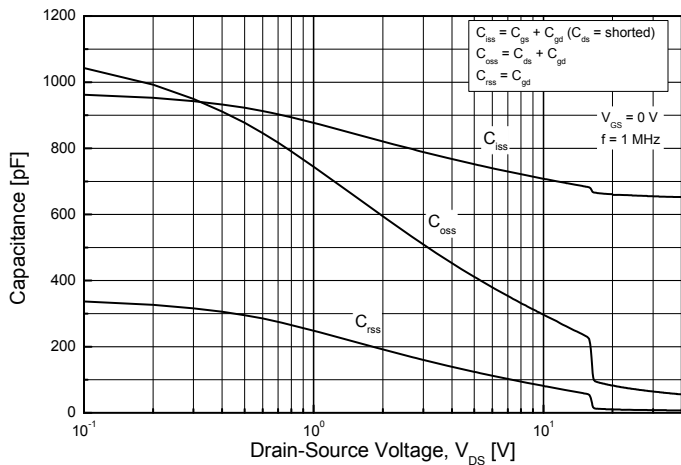
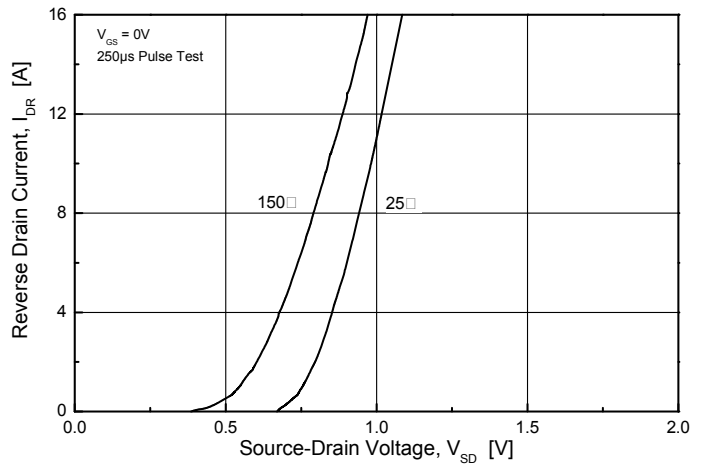
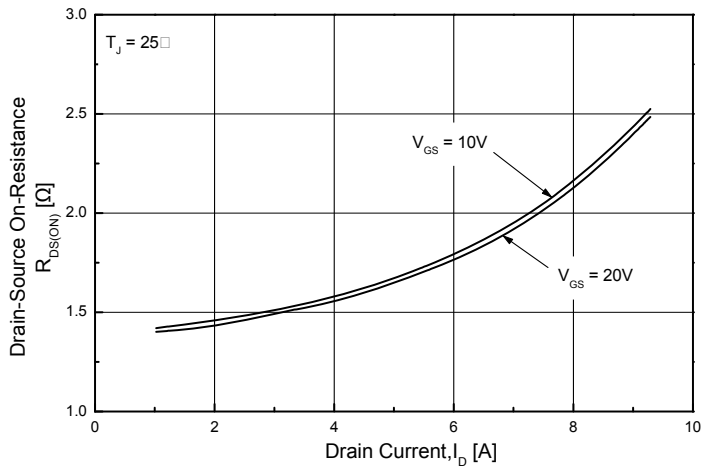
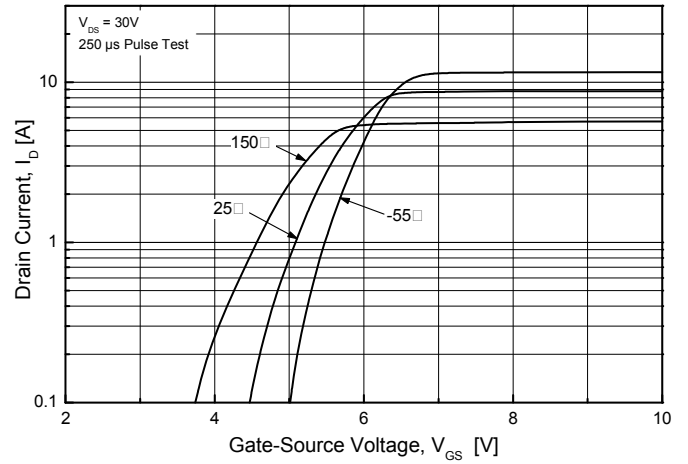
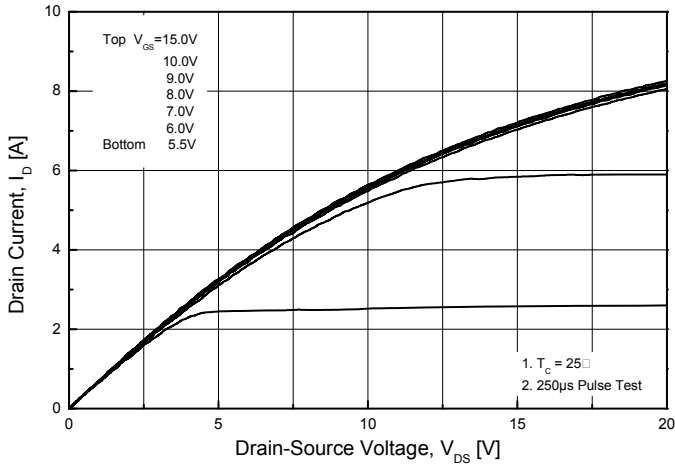

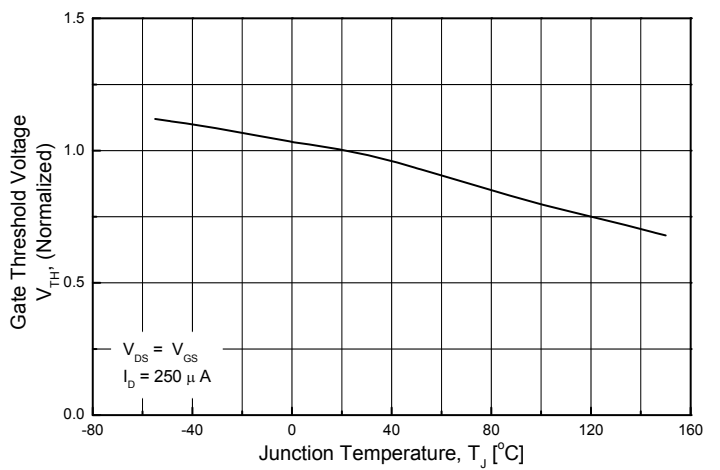
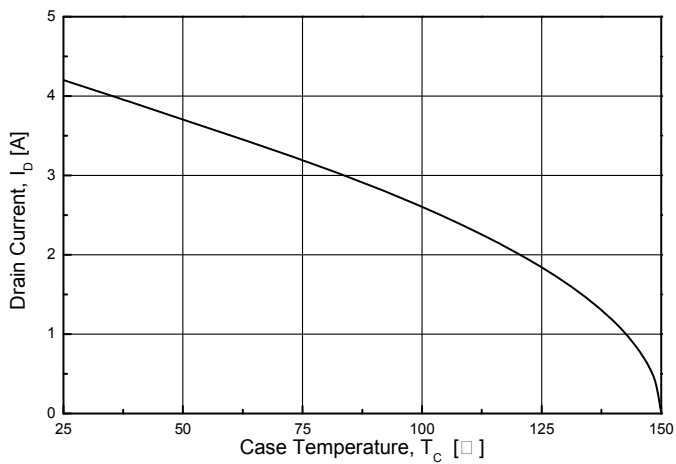
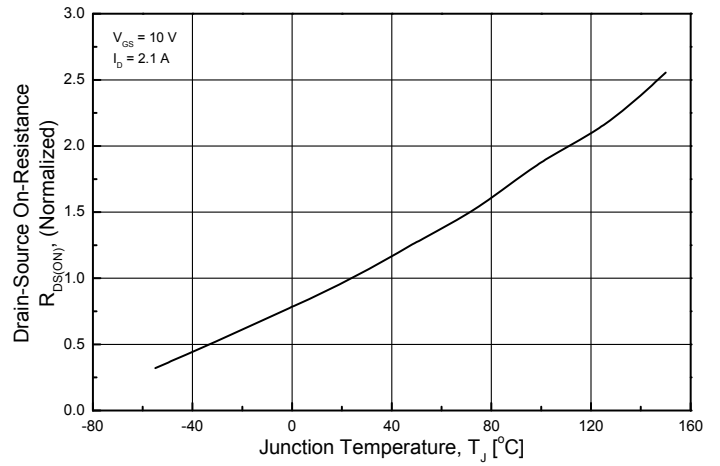
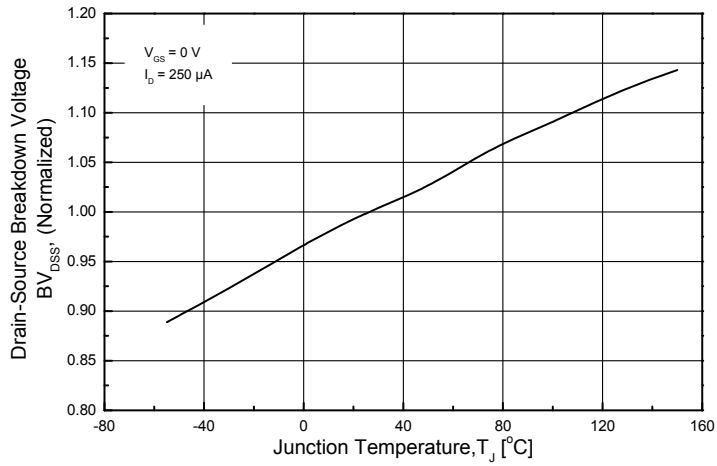

GP2M005A060HG

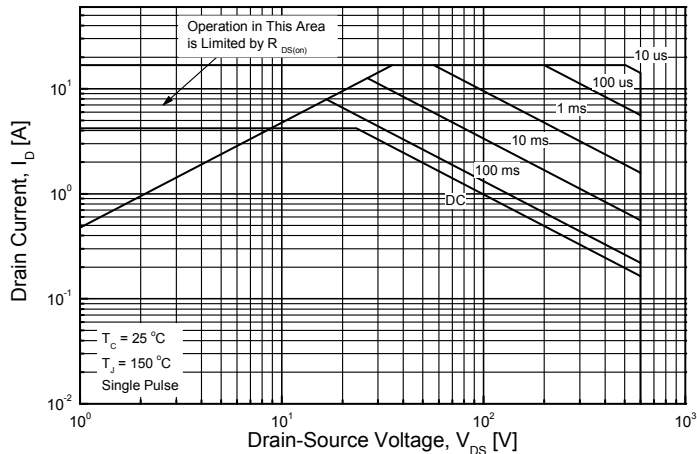

GP2M005A060FG

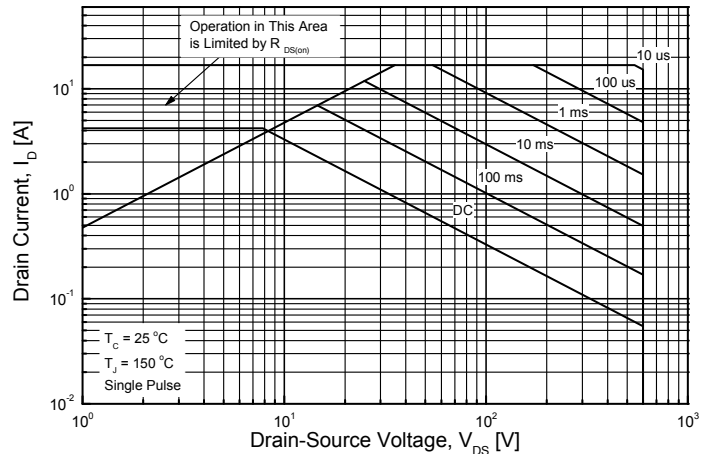

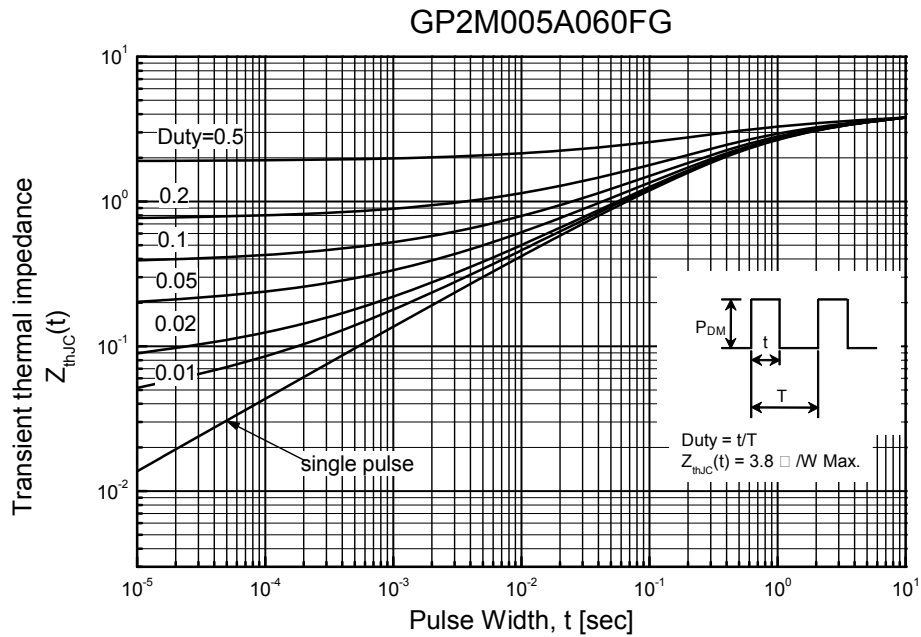
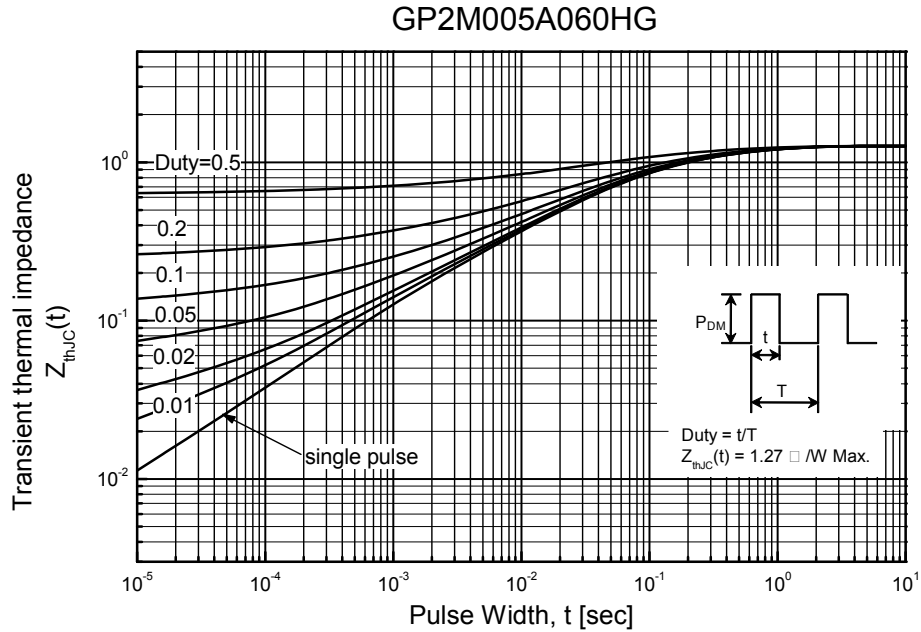

TO-220AB-3L MECHANICAL DATA

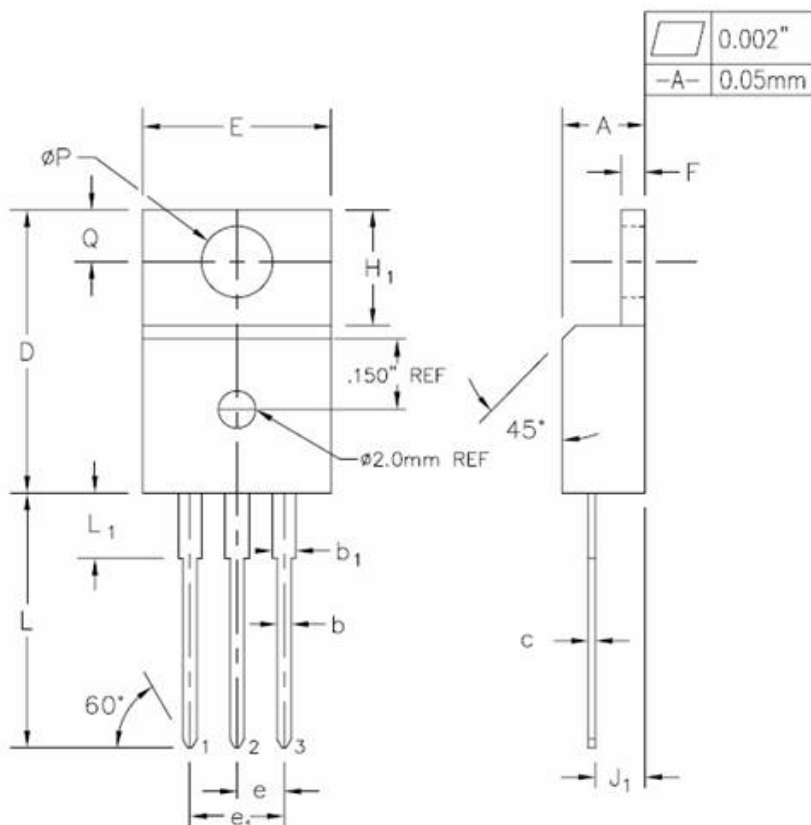

SYMBOL	INCHES		MILLIMETERS		NOTES
	MIN.	MAX.	MIN.	MAX.	
A	0.170	0.180	4.32	4.57	
b	0.028	0.036	0.71	0.91	
b ₁	0.045	0.055	1.15	1.39	
c	0.014	0.021	0.36	0.53	
D	0.590	0.610	14.99	15.49	
E	0.395	0.410	10.04	10.41	
e	0.100 TYP.		2.54 TYP.		
e ₁	0.200 BSC		5.08 BSC		
F	0.048	0.054	1.22	1.37	
H ₁	0.235	0.255	5.97	6.47	
J ₁	0.100	0.110	2.54	2.79	
L	0.530	0.550	13.47	13.97	
L ₁	0.130	0.150	3.31	3.81	2
∅P	0.149	0.153	3.79	3.88	
Q	0.102	0.112	2.60	2.84	

TO-220F-3L MECHANICAL DATA

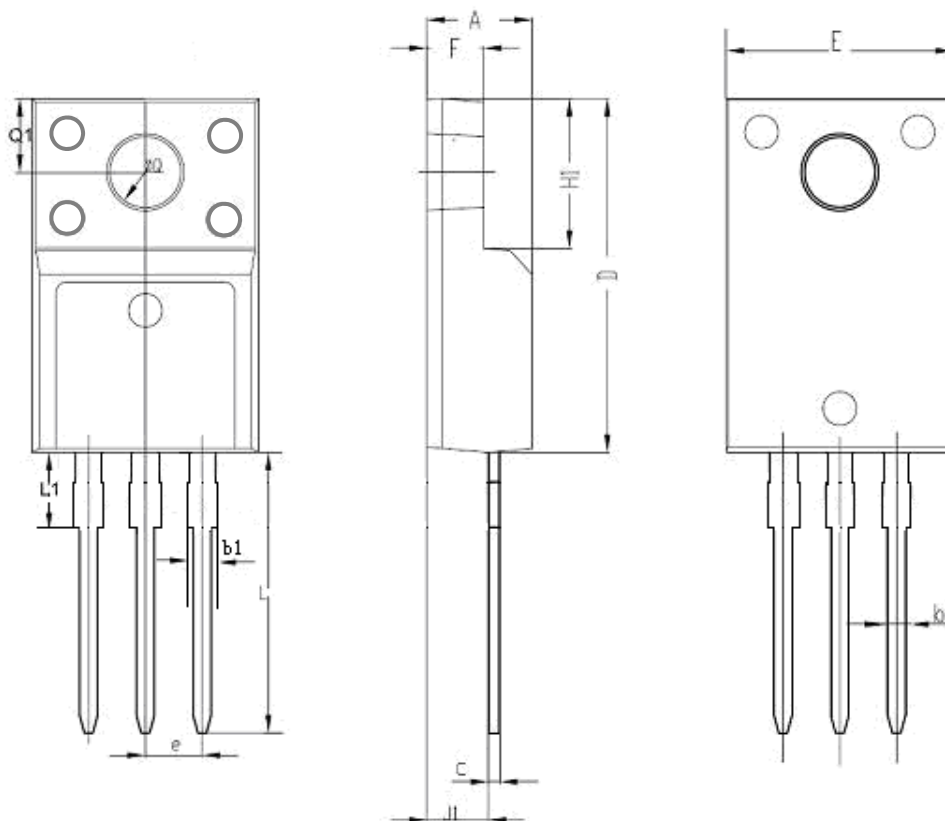

SYMBOL	INCHES		MILLIMETERS		NOTES
	MIN	MAX	MIN	MAX	
A	0.178	0.194	4.53	4.93	
b	0.028	0.036	0.71	0.91	
C	0.018	0.024	0.45	0.60	
D	0.617	0.633	15.67	16.07	
E	0.392	0.408	9.96	10.36	
e	0.100 TYP.		2.54TYP.		
H1	0.256	0.272	6.50	6.90	
J1	0.101	0.117	2.56	2.96	
L	0.503	0.519	12.78	13.18	
φQ	0.117	0.133	2.98	3.38	
b1	0.045	0.055	1.15	1.39	
L1	0.114	0.130	2.9	3.3	
Q1	0.122	0.138	3.10	3.50	
F	0.092	0.108	2.34	2.74	