

**User Guide for
FEBFSL3276ALR_IO01U25A
Evaluation Board**

**Integrated Controller
FSL3276ALRN
0.25 W Auxiliary Power Supply**

**Featured Fairchild Product:
FSL3276ALRN**

*Direct questions or comments
about this evaluation board to:
“Worldwide Direct Support”*

Fairchild Semiconductor.com

Table of Contents

1. Introduction.....	3
1.1. General Description	3
1.2. Features.....	3
2. Specifications.....	4
3. Photographs	5
4. PCB Layout.....	6
5. Test Conditions	7
6. Performance of Evaluation Board.....	8
6.1. Startup Performance.....	8
6.2. Normal Operation	9
6.3. Voltage Stress of Drain and Freewheeling Diode.....	10
6.4. Output Ripple and Noise.....	11
6.5. Step Load Response.....	13
6.6. Output Line & Load Regulation	14
6.7. Temperature Measurement	14
6.8. Efficiency Test Result.....	15
6.9. Standby Power Consumption.....	15
6.10. Conducted EMI Measurement	16
7. Schematic.....	17
8. Bill of Materials	17
9. Revision History	18

This user guide supports the evaluation kit for the FSL3276ALRN. It should be used in conjunction with the FSL3276ALRN datasheet as well as Fairchild's application notes and technical support team. Please visit Fairchild's website at www.fairchildsemi.com.

1. Introduction

This document is an engineering report describing measured performance of the FSL3276ALRN evaluation board.

1.1. General Description

The FSL3276ALRN is ideal to be configured as a non-isolated high voltage buck switch for low power applications. Its peak current is adjustable down to 70 mA which enables optimum inductor size selection. The modulation control is designed to reduce standby power to 25 mW at 230 V_{AC} input. Though the Pulse Width Modulator (PWM) and SenseFET are ideally integrated for high-performance offline buck, it can also be configured as a buck-boost or non-isolated flyback with minimal external components. This device integrates a high-voltage power regulator that enables operation without an auxiliary bias winding. An internal transconductance amplifier reduces external components for the feedback compensation circuit.

The integrated PWM controller includes: 10 V regulator for no external bias circuit, Under-Voltage Lockout (UVLO), Leading-Edge Blanking (LEB), an optimized gate turn-on / turn-off driver, EMI attenuator, Thermal Shutdown (TSD), temperature-compensated precision current sources for loop compensation, and fault-protection circuitry. Protections include: Overload Protection (OLP), Over-Voltage Protection (OVP), Open Feedback Loop Protection (OFLP), and Abnormal Over-Current Protection (AOCP). FSL3276ALRN offers good soft-start performance during startup.

The internal high-voltage startup switch and the Burst-Mode operation with very low operating current reduce the power loss in Standby Mode. As the result, it is possible to reach power loss of 120 mW below (including dummy load: 1 k Ω) without external bias when input voltage is 145 V_{AC}.

1.2. Features

- Built-in Avalanche-Rugged SenseFET: 650 V
- Fixed Operating Frequency: 50 kHz
- No-Load Power Consumption: <25 mW at 230 V_{AC} with External Bias; <120 mW at 230 V_{AC} without External Bias
- No Need for Auxiliary Bias Winding
- Frequency Modulation for Attenuating EMI
- Pulse-by-Pulse Current Limiting
- Ultra-Low Operating Current: 250 μ A
- Built-in Soft-Start and Startup Circuit
- Adjustable Peak Current Limit
- Built-in Transconductance (Error) Amplifier
- Various Protections: Overload Protection (OLP), Over-Voltage Protection (OVP), Open Feedback Loop Protection (OFLP), AOCP (Abnormal Over-Current Protection), Thermal Shutdown (TSD)
- Fixed 650 ms Restart Time for Safe Auto-Restart Mode of All Protections

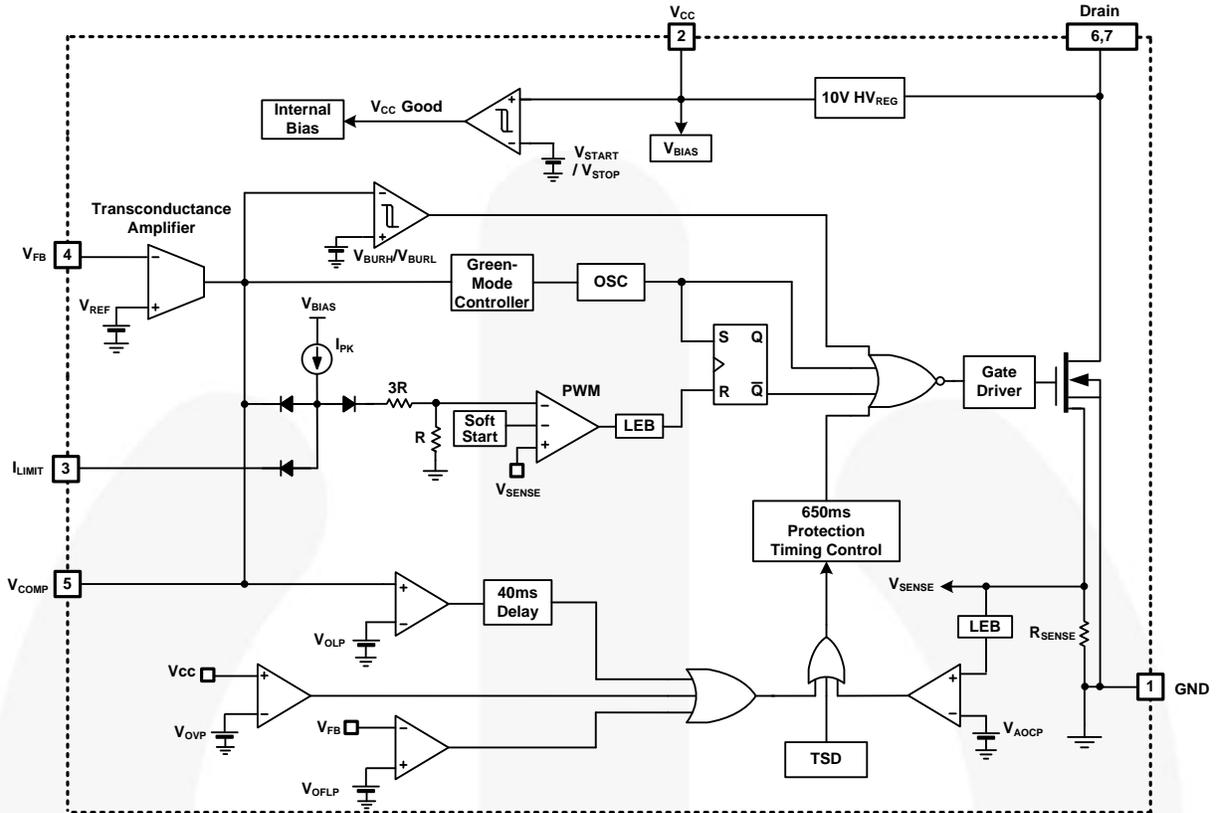

Figure 1. Internal Block Diagram

2. Specifications

Table 1. Evaluation Board Specifications

Fairchild Device	FSL3276ALRN
Input Voltage Range	85 ~ 145 V _{AC}
Frequency	60 Hz
Maximum Output Power	0.25 W
Output Full-Load Condition	5 V / 50 mA

3. Photographs



Figure 2. Top View (Dimension 18 x 18 [mm²])

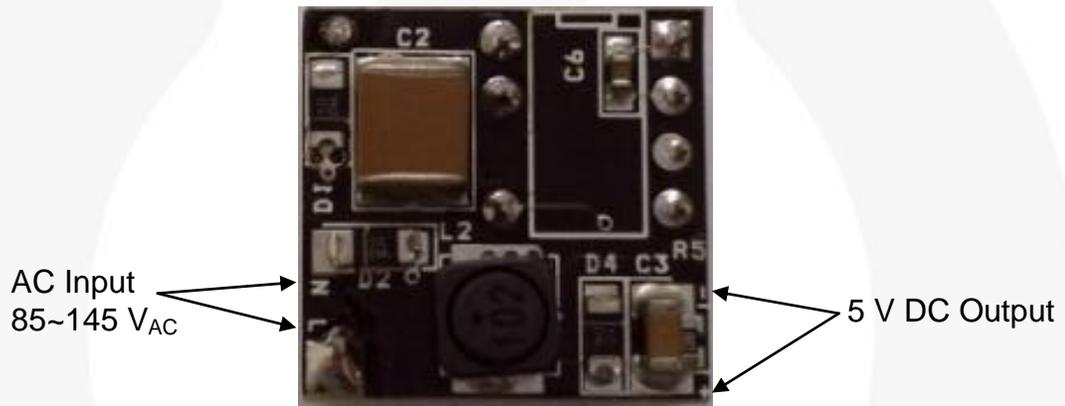

Figure 3. Bottom View (Dimension 18 x 18 [mm²])

4. PCB Layout

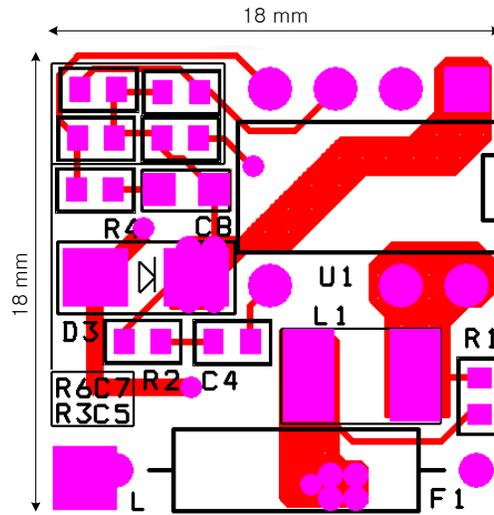

Figure 4. Top Overlay

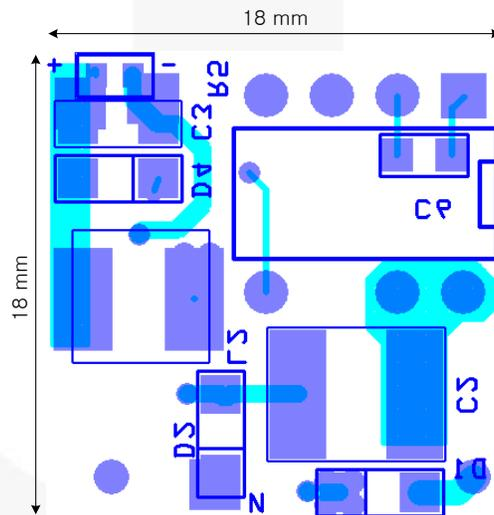

Figure 5. Bottom Overlay

5. Test Conditions

Evaluation Board #	FEBFSL3276ALRN
Test Date	JANUARY 8, 2016
Test Equipment	AC Source: 6800 Series Electronic Load: Fujitsu EML-05B & Actual Resistor Load Oscilloscope: LeCroy 104Xi-A Power Meter: Yokogawa PZ4000
Test Items	<ol style="list-style-type: none">1. Startup Performance2. Normal Operation3. Voltage Stress of Drain and Freewheeling Diode4. Output Ripple and Noise5. Step Load Response6. Output Line & Load Regulation7. Temperature Measurement8. Efficiency Test Result9. Standby Power Consumption10. Conducted EMI Measurement

6. Performance of Evaluation Board

6.1. Startup Performance

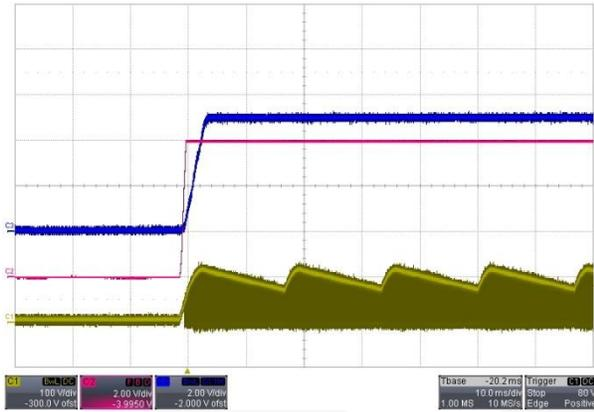

Figure 6. 85 V_{AC}, Full-Load Condition (CH1: V_{DS} (100 V/div), CH2: V_{CC} (2 V/div), CH3: 5 V_{OUT} (2 V/div), Time: 10 ms/div)

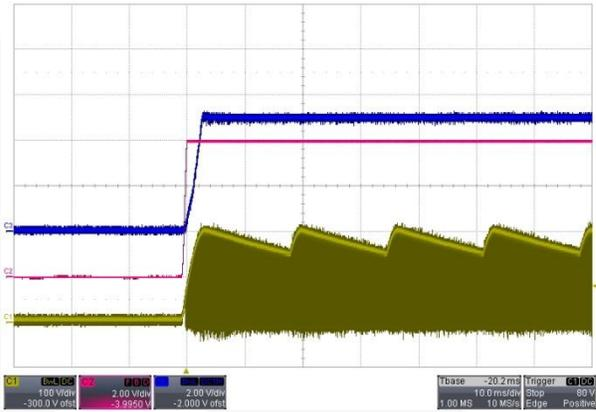

Figure 7. 145 V_{AC}, Full-Load Condition (CH1: V_{DS} (100 V/div), CH2: V_{CC} (2 V/div), CH3: 5 V_{OUT} (2 V/div), Time: 10 ms/div)

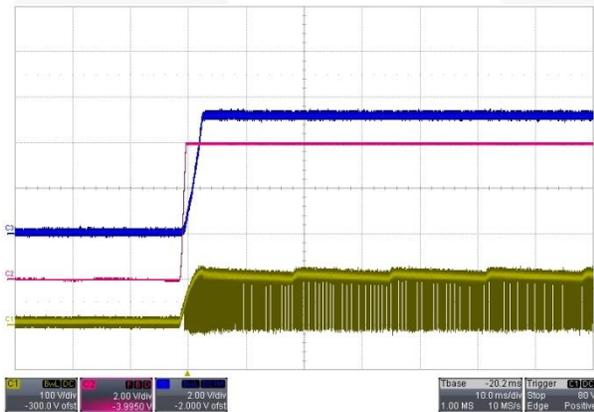

Figure 8. 85 V_{AC}, No-Load Condition (CH1: V_{DS} (100 V/div), CH2: V_{CC} (2 V/div), CH3: 5 V_{OUT} (2 V/div), Time: 10 ms/div)

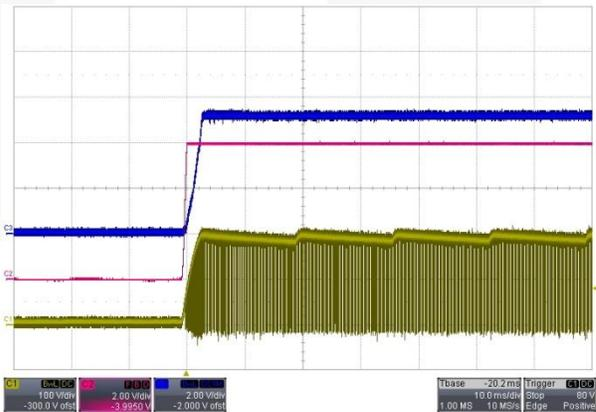

Figure 9. 145 V_{AC}, No-Load Condition (CH1: V_{DS} (100 V/div), CH2: V_{CC} (2 V/div), CH3: 5 V_{OUT} (2 V/div), Time: 10 ms/div)

6.2. Normal Operation

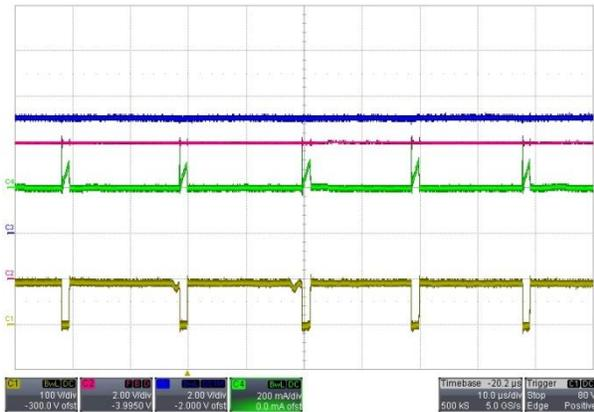

Figure 10. Full-Load Condition, 85 V_{AC}, (CH1: V_{DS} (100 V/div), CH2: V_{CC} (2 V/div), CH3: 5 V_{OUT} (2 V/div), CH4: I_{DS} (200 mA/div), Time: 10 μs/div)

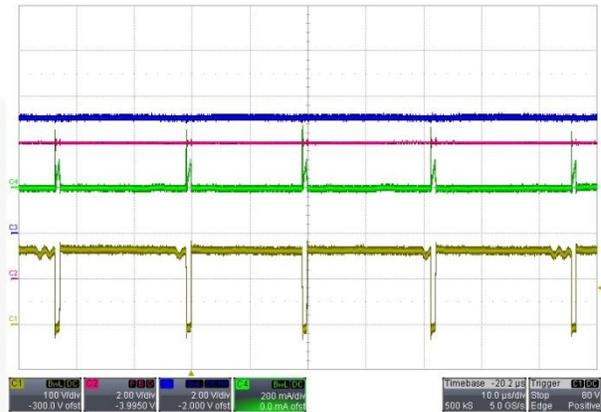

Figure 11. Full-Load Condition, 145 V_{AC}, (CH1: V_{DS} (100 V/div), CH2: V_{CC} (2 V/div), CH3: 5 V_{OUT} (2 V/div), CH4: I_{DS} (200 mA/div), Time: 10 μs/div)

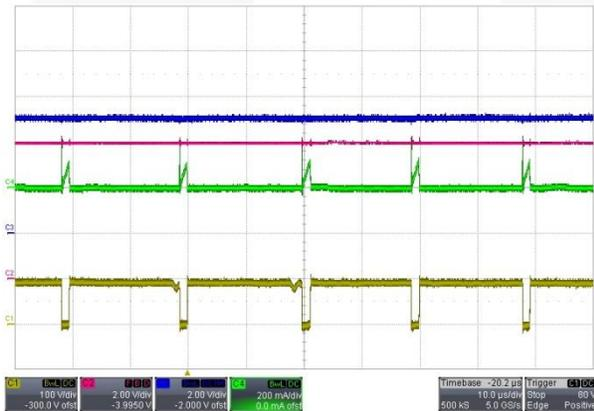

Figure 12. No-Load Condition, 85 V_{AC}, (CH1: V_{DS} (100 V/div), CH2: V_{CC} (2 V/div), CH3: 5 V_{OUT} (2 V/div), CH4: I_{DS} (200 mA/div), Time: 10 μs/div)

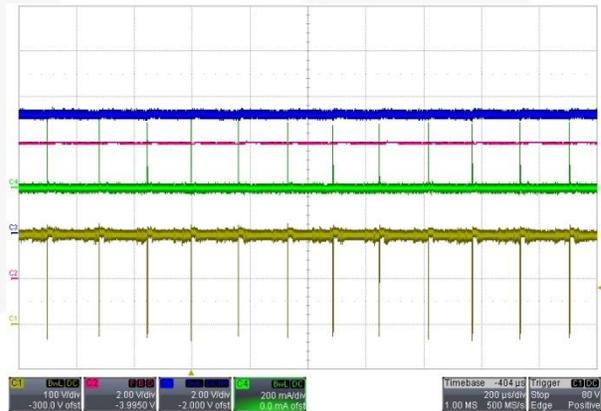

Figure 13. No-Load Condition, 145 V_{AC}, (CH1: V_{DS} (100 V/div), CH2: V_{CC} (2 V/div), CH3: 5 V_{OUT} (2 V/div), CH4: I_{DS} (200 mA/div), Time: 200 μs/div)

6.3. Voltage Stress of Drain and Freewheeling Diode

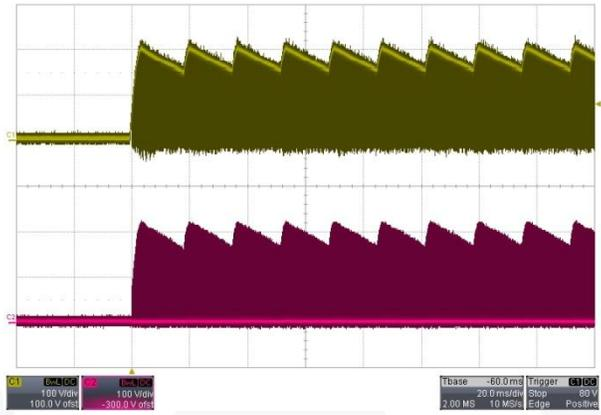

Figure 14. $V_{DS}=213\text{ V}$, $V_{DIODE}=226\text{ V}$, Startup Condition, Full-Load Condition, 145 V_{AC} ,
(CH1: V_{DS} (100 V/div), CH2: V_{DIODE} (100 V/div), Time: 20 ms/div)

6.4. Output Ripple and Noise

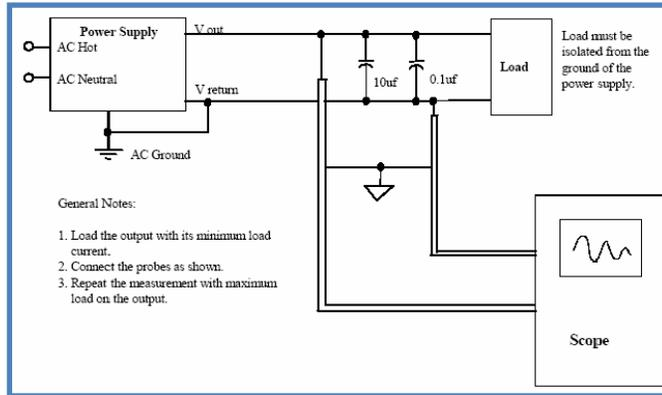

Figure 15. Recommended Test Setup

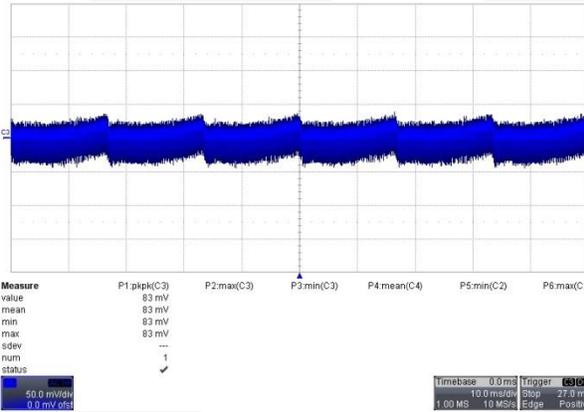

Figure 16. $5 V_{OUT_RIPPLE} = 83$ mV, Output Voltage Ripple with $85 V_{AC}$ and Full-Load Condition, CH3: $5 V_{OUT}$ (50 mV/div), Time: 10 ms/div

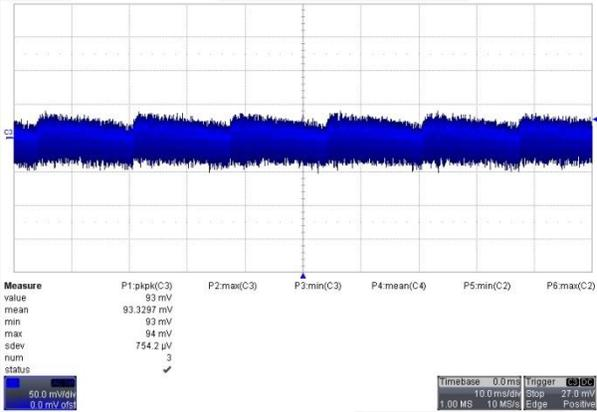

Figure 17. $5 V_{OUT_RIPPLE} = 94$ mV, Output Voltage Ripple with $145 V_{AC}$ and Full-Load Condition, CH3: $5 V_{OUT}$ (50 mV/div), Time: 10 ms/div

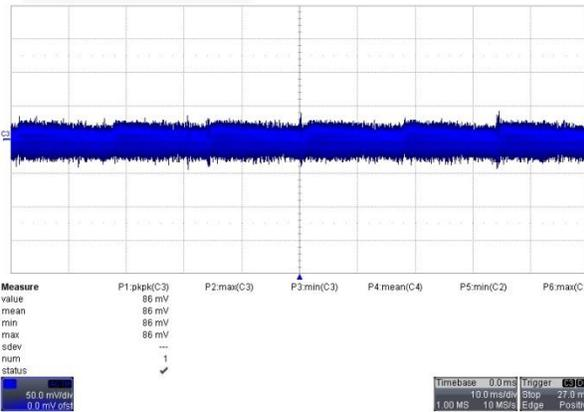

Figure 18. $5 V_{OUT_RIPPLE} = 86$ mV, Output Voltage Ripple with $85 V_{AC}$ and Half-Load Condition, CH3: $5 V_{OUT}$ (50 mV/div), Time: 10 ms/div

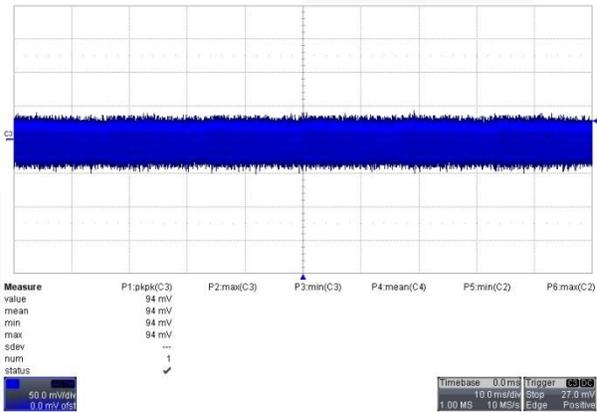

Figure 19. $5 V_{OUT_RIPPLE} = 94$ mV, Output Voltage Ripple with $145 V_{AC}$ and Half-Load Condition, CH3: $5 V_{OUT}$ (50 mV/div), Time: 10 ms/div

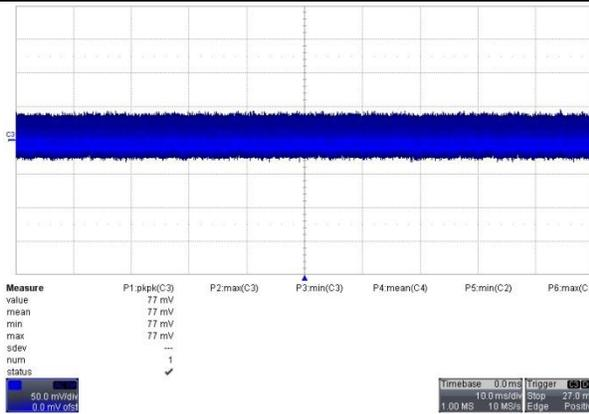

Figure 20. 5 V_{OUT_RIPPLE} = 77 mV, Output Voltage Ripple with 85 V_{AC} and No-Load Condition, CH3: 5 V_{OUT} (50 mV/div), Time: 10 ms/div

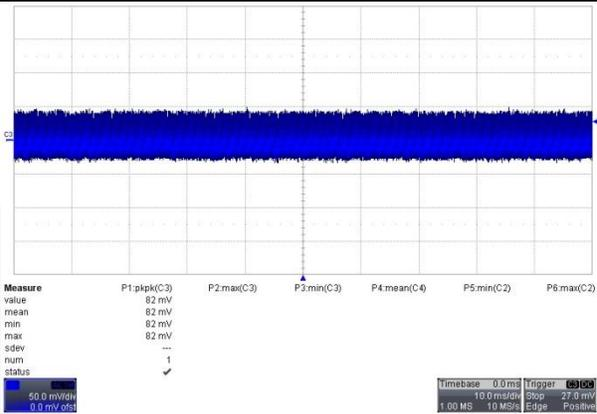

Figure 21. 5 V_{OUT_RIPPLE} = 82 mV, Output Voltage Ripple with 145 V_{AC} and No-Load Condition, CH3: 5 V_{OUT} (50 mV/div), Time: 10 ms/div

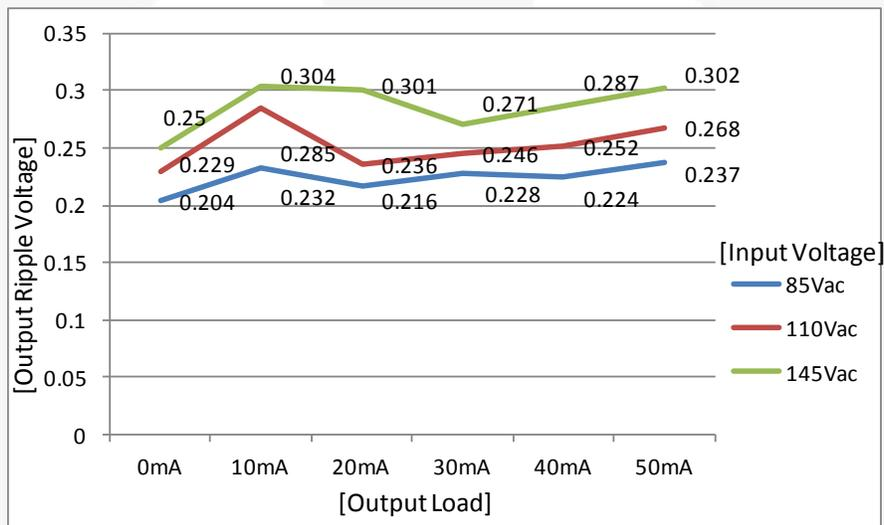

Figure 22. 5 V Output Ripple according to the Input Voltage variation

6.5. Step Load Response

Test Slew Rate (250 mA/ μ s)

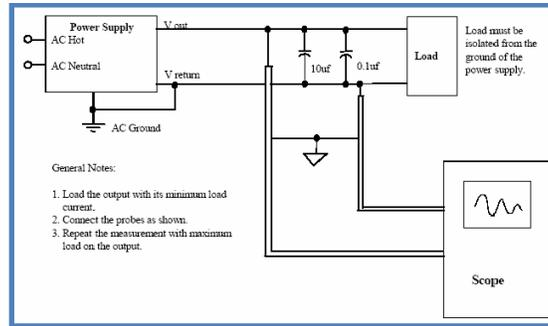

Figure 23. Recommended Test Setup

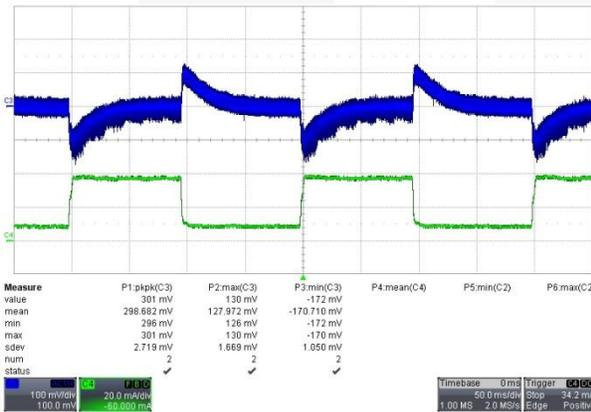

Figure 24. Overshoot = 130 mV, Undershoot = 172 mV, 5 V Output Step Load with 85 V_{AC}, 80% Load \leftrightarrow 20% Load (CH3: 5 V_{OUT} (100 mV/div), CH4: I_{OUT} (20 mA/div) Time: 50 ms/div)

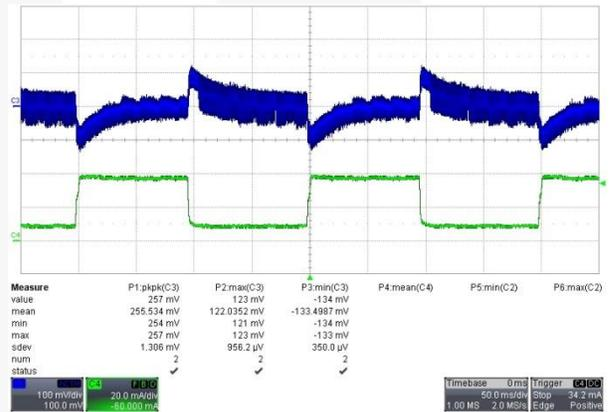

Figure 25. Overshoot = 123 mV, Undershoot = 134 mV, 5 V Output Step Load with 110 V_{AC}, 80% Load \leftrightarrow 20% Load (CH3: 5 V_{OUT} (100 mV/div), CH4: I_{OUT} (20 mA/div) Time: 50 ms/div)

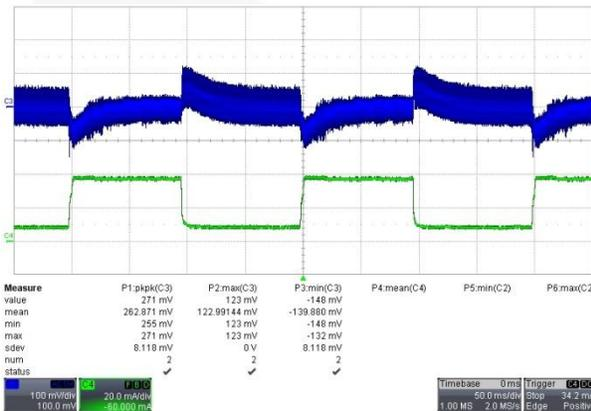

Figure 26. Overshoot = 123 mV, Undershoot = 148 mV, 5 V Output Step Load with 145 V_{AC}, 80% Load \leftrightarrow 20% Load (CH3: 5 V_{OUT} (100 mV/div), CH4: I_{OUT} (20 mA/div) Time: 50 ms/div)

6.6. Output Line & Load Regulation

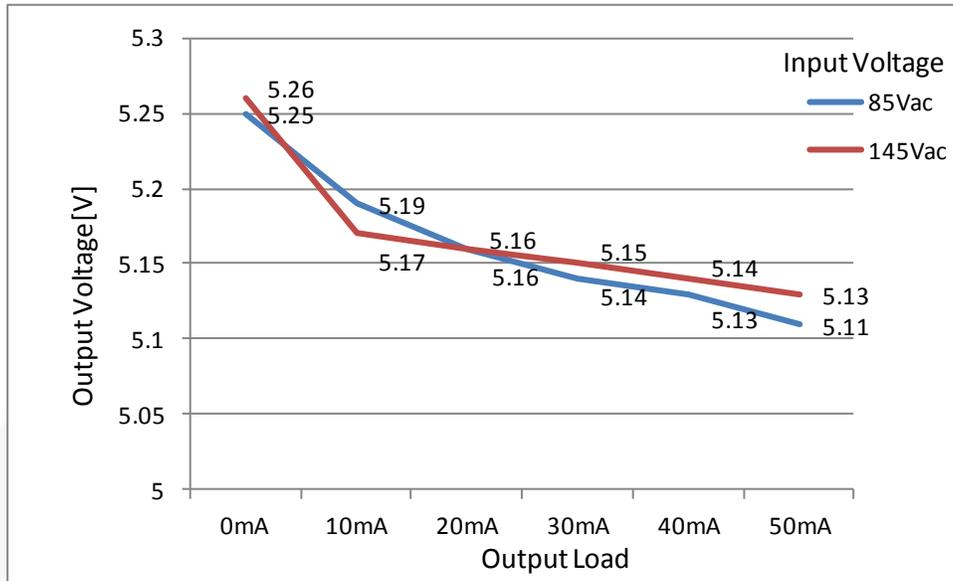

Figure 27. 5 V Output & Load Regulation

6.7. Temperature Measurement

Table 2. Temperature Test Result

Input Voltage		85 V _{AC}	110 V _{AC}	145 V _{AC}
Temperature	IC (FSL3276ALRN)	< 30°C		
	Freewheeling Diode (ES1J)			
	Inductor (PKS0807-681K-TF)			
Room Temperature		25°C		

6.8. Efficiency Test Result

- Test Method:
 - Test after 10 minutes aging.
 - Test from heavy load to light-load.

Table 3. Efficiency Test Result

Input Condition	Load Variation, Full Load: 5 V, 50 mA			
	100%	75%	50%	25%
85 V _{AC}	53.53%	50.72%	44.21%	33.65%
110 V _{AC}	51.40%	48.00%	41.47%	30.39%
145 V _{AC}	47.69%	43.88%	37.65%	28.33%

6.9. Standby Power Consumption

V _{IN} Condition	85 V _{AC}	110 V _{AC}	145 V _{AC}
With 1 k Ω Dummy Load	84 mW	98 mW	116 mW

6.10. Conducted EMI Measurement

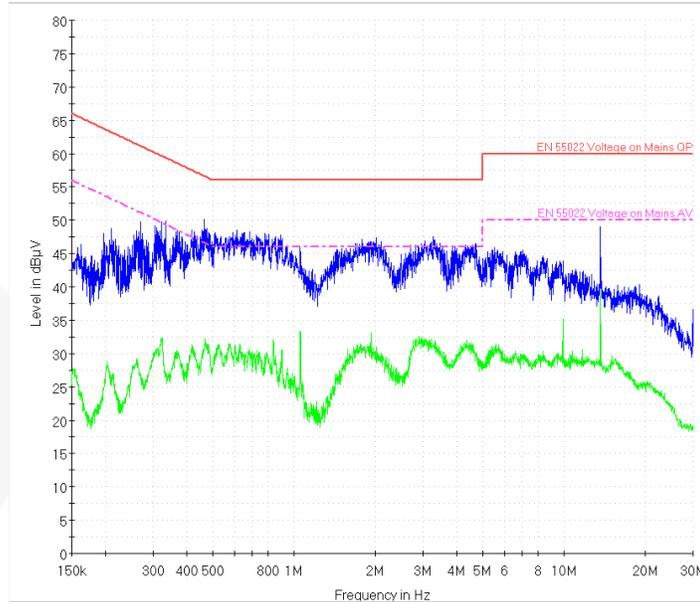

Figure 28. 110 V_{AC} <L> & 5 V / 50 mA

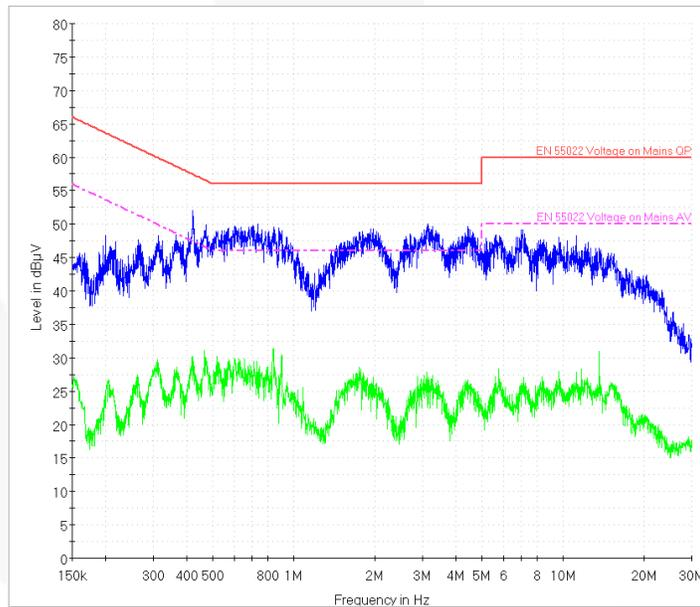

Figure 29. 110 V_{AC} <N> & 5 V / 50 mA

7. Schematic

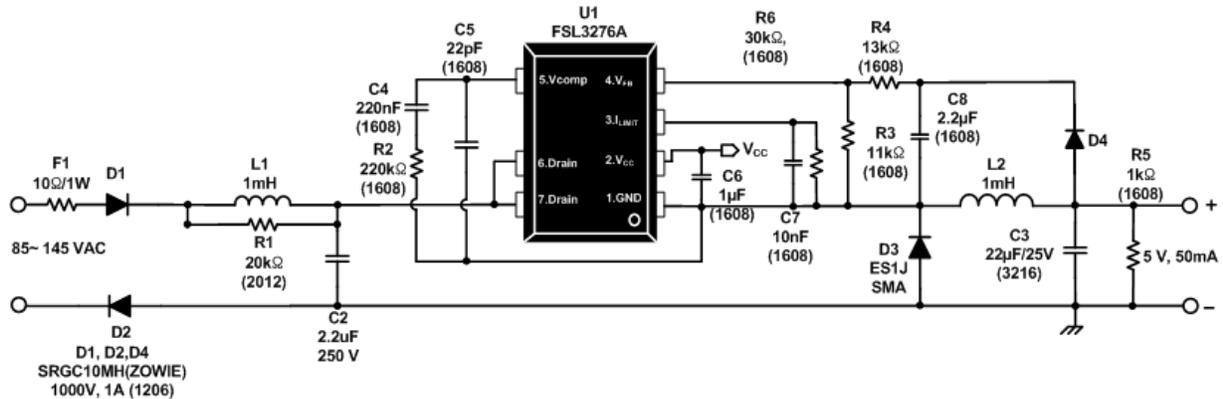

Figure 30. Schematic and Bill of Materials

8. Bill of Materials

Component	Qty.	Part No.	Manufacturer	Reference
Chip Resistor 0805 1 kΩ ±5%	1			R2
Chip Resistor 0805 3.3 kΩ ±5%	1			R7
Chip Resistor 0805 11.5 kΩ ±1%	1			R4
Chip Resistor 0805 13 kΩ ±1%	1			R3
Chip Resistor 0805 180 kΩ ±5%	1			R5
0805 MLCC X7R ±10% 47P (47 pF) 50 V	1			C9
0805 MLCC X7R ±10% 103P (10 nF) 50 V	1			C7
0805 MLCC X7R ±10% 104P (100 nF) 50 V	2			C5, C6
0805 MLCC X7R ±10% 224P (220 nF) 50 V	1			C8
0805 MLCC X7R ±10% 225P (2.2 μF) 50 V	1			C4
Ceramic Capacitor 2.2 μF 250 V	1	C5750X7T2E225M250KE	TDK	C2
1206 MLCC ±10% 226P 22 μF 25 V	1			C3
Fixed Inductor 1 mH ±10%	1	EC36-102K	SYNTON	L1
Inductor DR8X7 1 mH	1	PKS0807-102K-TF	3L Electronic	L2
General Diode 1 A / 600 V SMA	2	S1J	Fairchild Semiconductor	D1, D2
Fast Recovery Diode 1 A / 600 V SMA	1	RS1J	Fairchild Semiconductor	D4
Super Fast Diode 1 A / 600 V SMA	1	ES1J	Fairchild Semiconductor	D3
IC SMPS Power Switch	1	FSL3276ALRN	Fairchild Semiconductor	U1
Wire Wound Resistor 1 W 10R ±5%	1			RF



9. Revision History

Rev.	Date	Description
1.0	March 21,2016	Initial Release

WARNING AND DISCLAIMER

Replace components on the Evaluation Board only with those parts shown on the parts list (or Bill of Materials) in the Users' Guide. Contact an authorized Fairchild representative with any questions.

This board is intended to be used by certified professionals, in a lab environment, following proper safety procedures. Use at your own risk. The Evaluation board (or kit) is for demonstration purposes only and neither the Board nor this User's Guide constitute a sales contract or create any kind of warranty, whether express or implied, as to the applications or products involved. Fairchild warrants that its products meet Fairchild's published specifications, but does not guarantee that its products work in any specific application. Fairchild reserves the right to make changes without notice to any products described herein to improve reliability, function, or design. Either the applicable sales contract signed by Fairchild and Buyer or, if no contract exists, Fairchild's standard Terms and Conditions on the back of Fairchild invoices, govern the terms of sale of the products described herein.

DISCLAIMER

FAIRCHILD SEMICONDUCTOR RESERVES THE RIGHT TO MAKE CHANGES WITHOUT FURTHER NOTICE TO ANY PRODUCTS HEREIN TO IMPROVE RELIABILITY, FUNCTION, OR DESIGN. FAIRCHILD DOES NOT ASSUME ANY LIABILITY ARISING OUT OF THE APPLICATION OR USE OF ANY PRODUCT OR CIRCUIT DESCRIBED HEREIN; NEITHER DOES IT CONVEY ANY LICENSE UNDER ITS PATENT RIGHTS, NOR THE RIGHTS OF OTHERS.

LIFE SUPPORT POLICY

FAIRCHILD'S PRODUCTS ARE NOT AUTHORIZED FOR USE AS CRITICAL COMPONENTS IN LIFE SUPPORT DEVICES OR SYSTEMS WITHOUT THE EXPRESS WRITTEN APPROVAL OF THE PRESIDENT OF FAIRCHILD SEMICONDUCTOR CORPORATION.

As used herein:

1. Life support devices or systems are devices or systems which, (a) are intended for surgical implant into the body, or (b) support or sustain life, or (c) whose failure to perform when properly used in accordance with instructions for use provided in the labeling, can be reasonably expected to result in significant injury to the user.
2. A critical component is any component of a life support device or system whose failure to perform can be reasonably expected to cause the failure of the life support device or system, or to affect its safety or effectiveness.

ANTI-COUNTERFEITING POLICY

Fairchild Semiconductor Corporation's Anti-Counterfeiting Policy. Fairchild's Anti-Counterfeiting Policy is also stated on our external website, www.fairchildsemi.com, under Sales Support.

Counterfeiting of semiconductor parts is a growing problem in the industry. All manufacturers of semiconductor products are experiencing counterfeiting of their parts. Customers who inadvertently purchase counterfeit parts experience many problems such as loss of brand reputation, substandard performance, failed applications, and increased cost of production and manufacturing delays. Fairchild is taking strong measures to protect ourselves and our customers from the proliferation of counterfeit parts. Fairchild strongly encourages customers to purchase Fairchild parts either directly from Fairchild or from Authorized Fairchild Distributors who are listed by country on our web page cited above. Products customers buy either from Fairchild directly or from Authorized Fairchild Distributors are genuine parts, have full traceability, meet Fairchild's quality standards for handling and storage and provide access to Fairchild's full range of up-to-date technical and product information. Fairchild and our Authorized Distributors will stand behind all warranties and will appropriately address any warranty issues that may arise. Fairchild will not provide any warranty coverage or other assistance for parts bought from Unauthorized Sources. Fairchild is committed to combat this global problem and encourage our customers to do their part in stopping this practice by buying direct or from authorized distributors.

EXPORT COMPLIANCE STATEMENT

These commodities, technology, or software were exported from the United States in accordance with the Export Administration Regulations for the ultimate destination listed on the commercial invoice. Diversion contrary to U.S. law is prohibited.

U.S. origin products and products made with U.S. origin technology are subject to U.S Re-export laws. In the event of re-export, the user will be responsible to ensure the appropriate U.S. export regulations are followed.