



xsens

MTi 1-series Development Kit

MTi-3-DK and MTi-7-DK User Manual

Document MT0513P, Revision D, 24 March 2018

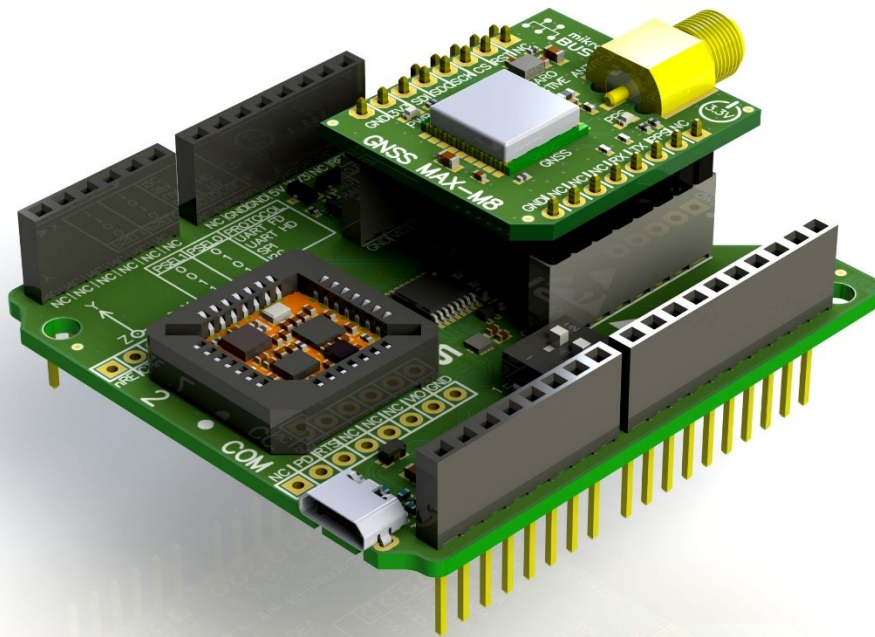

Xsens Technologies B.V.

Pantheon 6a
P.O. Box 559
7500 AN Enschede
The Netherlands

phone +31 (0)88 973 67 00
fax +31 (0)88 973 67 01
e-mail info@xsens.com
internet www.xsens.com

Xsens North America, Inc.

10557 Jefferson Blvd,
Suite C
CA-90232 Culver City
USA

phone 310-481-1800
fax 310-416-9044
e-mail info@xsens.com
internet www.xsens.com



Revisions

| Revision | Date | By | Changes |
|----------|---------------|-----|---|
| A | 8 July 2015 | MHA | Initial release |
| ... | ... | ... | ... |
| D | 24 March 2018 | AVY | Document caters only to <ul style="list-style-type: none">- MTi-3-DK (HW version \geq 2.0)- MTi-7-DK (New release, HW version \geq 2.0) Removed any references to previous version of the DK (MTi-3-8A7G6x, HW \leq 1.1) |

© 2005-2018, Xsens Technologies B.V. All rights reserved. Information in this document is subject to change without notice. Xsens, MVN, MotionGrid, MTi, MTx and Awinda are registered trademarks or trademarks of Xsens Technologies B.V. and/or its parent, subsidiaries and/or affiliates in The Netherlands, the USA and/or other countries. All other trademarks are the property of their respective owners.



Table of Contents

| | | |
|----------|--|----------|
| 1 | GENERAL INFORMATION | 1 |
| 1.1 | PACKAGE INFORMATION | 1 |
| 1.2 | ORDERING INFORMATION..... | 2 |
| 2 | INTRODUCTION | 3 |
| 2.1 | KIT CONTENTS AND FEATURES | 3 |
| 2.2 | SOFTWARE AND DOCUMENTATION..... | 4 |
| 2.2.1 | <i>Embedded examples</i> | 4 |
| 3 | GETTING STARTED | 5 |
| 3.1 | INSTALLING MT SOFTWARE SUITE | 5 |
| 3.2 | DISPLAYING DATA IN MT MANAGER..... | 6 |
| 3.3 | CONFIGURING THE MTi 1-SERIES..... | 7 |
| 4 | SHIELD BOARD | 8 |
| 4.1 | CONNECTIONS AND PERIPHERAL SWITCH..... | 8 |
| 4.2 | PIN DESCRIPTIONS..... | 12 |
| 4.3 | ELECTRICAL SPECIFICATIONS | 13 |
| 4.4 | ABSOLUTE MAXIMUM RATINGS | 13 |
| 4.5 | PACKAGE DRAWING | 14 |



List of Tables

| | |
|--|----|
| Table 1: Package contents for 1-series Development Kits | 1 |
| Table 2: Ordering information for 1-series Development Kits | 2 |
| Table 3: Connections on external power header (J100 in Figure 7) | 9 |
| Table 4: Connections on Arduino-compatible header (P100, P101, P102 and P103 in Figure 7)..... | 9 |
| Table 5: Connections on UART communication extension sockets (P202 and P203 in Figure 7) | 10 |
| Table 6: Switch positions to enable interfaces on Shield Board (SW200 in Figure 7)..... | 10 |
| Table 7: Connections on auxiliary sensor extension sockets (P200 and P201 in Figure 7) | 11 |
| Table 8: Pin descriptions Shield Board | 12 |
| Table 9: System specification Shield Board | 13 |
| Table 10: Absolute maximum ratings Shield Board | 13 |

List of Figures





| | |
|---|----|
| Figure 1: Exploded view of the MTi 1-series Shield board | 3 |
| Figure 2: Start up screen for MT Software Suite installer | 5 |
| Figure 3: Software components installation | 5 |
| Figure 4: Successful installation screen | 6 |
| Figure 5: MT Manager overview..... | 6 |
| Figure 6: Output configuration dialog in MT Manager using an MTi-7-DK..... | 7 |
| Figure 7: MTi 1-series Shield Board with connector designators..... | 8 |
| Figure 8: Top view (left) and the bottom view (right) of the GNSS daughter card | 11 |
| Figure 9: MTi 1-series Shield Board package drawing (Top and Side view) | 14 |

1 General information

This document provides information on the contents and usage of the MTi 1-series Development Kits. The MTi 1-series module (MTi 1-s) is a fully functional, self-contained module that is easy to design-in. The MTi 1-s can be connected to a host through I²C, SPI or UART interfaces. The MTi-3 Development Kit (MTi-3-DK) enables users to evaluate features for the MTi-3 (AHRS), MTi-2 (VRU) and MTi-1 (IMU) modules. The MTi-7 Development Kit (MTi-7-DK) enables users to evaluate features of the MTi-7 (external-GNSS/INS). In addition to the MTi 1-s interfaces, both Development Kits include a USB interface.

1.1 Package information

Table 1: Package contents for 1-series Development Kits

| Component | Name |
|---|---------------------------------|
|  | Shield board |
|  | MTi 1-series module (MTi 1-s) |
|  | GNSS daughter card ¹ |
|  | GNSS antenna ¹ |
|  | USB cable |

¹ Only with MTi-7-DK



1.2 Ordering information

Table 2: Ordering information for 1-series Development Kits

| Kit | Description | Package contents | Packing Method |
|----------|---|---|----------------|
| MTi-7-DK | Development kit for MTi-7 (external-GNSS-aided-AHRS) | <ul style="list-style-type: none">- Shield board- MTi-7 module (in the socket)- GNSS daughter card- GNSS antenna- USB cable | Single unit |
| MTi-3-DK | Development kit for MTi-1 (IMU), MTi-2 (VRU) and MTi-3 (AHRS) | <ul style="list-style-type: none">- Shield board- MTi-3 module (in the socket)- USB cable | Single unit |

2 Introduction

2.1 Kit contents and features

The MTi 1-series Development Kit contains

- Shield board
- MTi-3 or MTi-7 mounted in the socket
- GNSS daughter card (only with MTi-7-DK)
- GNSS antenna (only with MTi-7-DK)
- USB cable

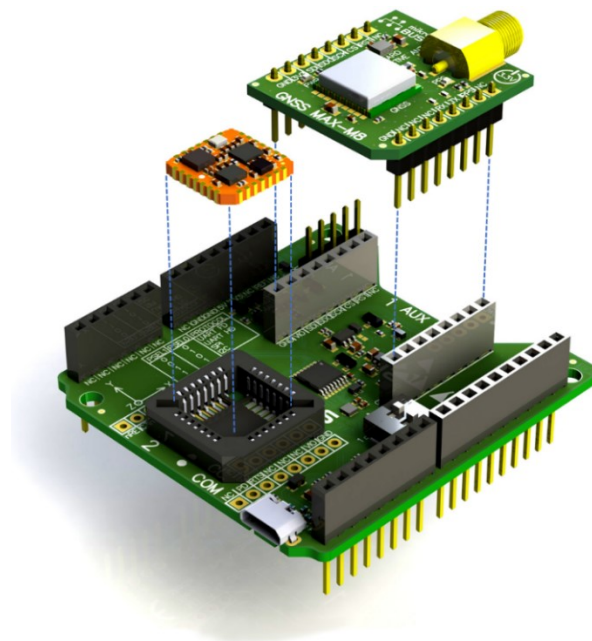

Figure 1: Exploded view of the MTi 1-series Shield board

The Shield Board, the MTi 1-s (orange module) and the GNSS daughter card (with the SMA connector) are shown in Figure 1. The features of the Shield Board include:

- 3.3 V compatible I/O
- Power indicator LEDs
- Arduino-compatible headers
- External power pin header
- Manual peripheral selection switch for MTi 1-series
- Switching between UART and I²C on Arduino-compatible headers based on PSEL switch setting
- USB to UART converter
- Auxiliary extension socket
- Optional socket connections for mikroBUS™ RS232/RS485 click boards™

See Section 4 for more details.



2.2 Software and documentation

The MTi 1-series Development Kit is supported by the MT Software Suite, which includes the following software components:

- MT Manager
- Magnetic Field Mapper
- MT SDK with documentation

Additionally, the latest firmware for the MTi-3 or the MTi-7 module can be downloaded and updated using the Firmware Updater that is also available on our website.

The Software components can be downloaded from the Xsens website – www.xsens.com.

Along with the SDK documentation that is part of the MT Software Suite installer package, the MTi 1-series Development Kit is supported by the following additional documents²

- Hardware Integration Manual: MTi 1-series (MT1503)
- Datasheet: MTi 1-series (MT0512P)
- MT Low Level Communication Protocol (MT0101P)
- MT Manager User Manual (MT0216P)
- MT Magnetic Field Mapper Documentation (MT0202P)
- Product Change Notification
 - o *MTi 1-series: Components placement change*

2.2.1 Embedded examples

The MTi 1-series is designed for easy integration in embedded systems. To aid in development, example code is provided for the ARM® Mbed™ platform.

An example implementation of the Xbus Low Level Communication Protocol is provided as generic C99 compliant source code³, while an ARM® Mbed™ specific application demonstrates the use of the Xbus library to communicate with an MTi 1-series development kit using UART communications.

The example code has been tested with the following ARM® Mbed™ compatible boards:

- ST Nucleo F302R8 – Cortex M4
- FreeScale FRDM-KL46Z – Cortex M0+
- NXP EA LPC 4088 – Cortex M4

The example code is available at <http://www.mbed.org/teams/Xsens>. Documentation on how to use the project is provided on the description page and in the code. Note that these examples are provided as is and are not supported by the Xsens support team. The examples are licensed under the [Apache Licence version 2.0](#).

It is easy to extend the program with commands from the Xsens Low Level Communication Protocol (LLCP). This protocol is documented in detail in the Low Level Communication Protocol Documentation.

² The MT SDK and other documentation links can be found here 'C:\Program Files\Xsens\MT Software Suite x.x.x\Documentation'.

³ Xbus example code is not specific to ARM processors and should be compatible with other embedded architectures.

3 Getting started

3.1 Installing MT Software Suite

The MT Software Suite is available from the Xsens website (www.xsens.com/mt-software-suite).

The installation procedure consists of a set of several installers and starts with the GUI as shown in Figure 2.

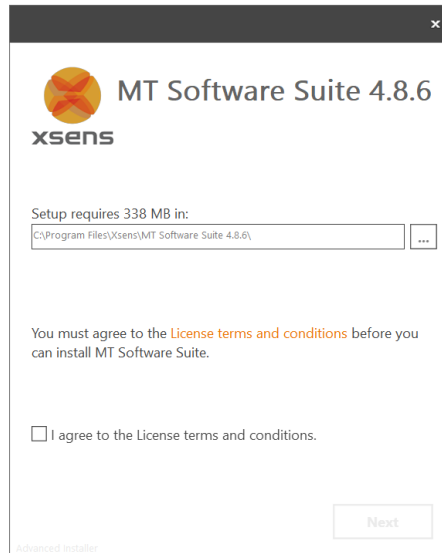

Figure 2: Start up screen for MT Software Suite installer

It is possible to choose the components that you need to install (Figure 3).

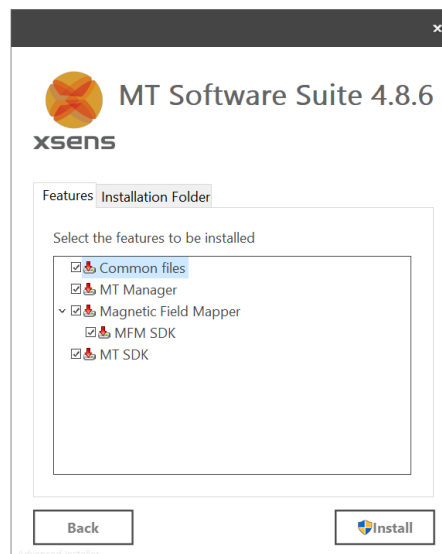

Figure 3: Software components installation

When you cancel the installation of a particular component, the installer will continue with the next component. Make sure to accept the End-User License agreement and Software License Agreements, and then wait for the successful installation screen to appear as shown in Figure 4.

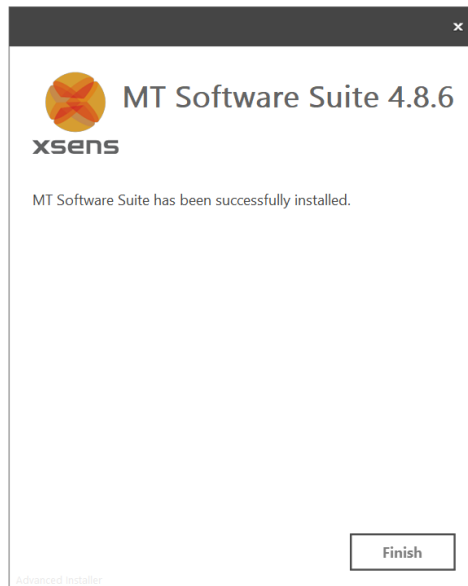





Figure 4: Successful installation screen

3.2 Displaying data in MT Manager

When the MTi 1-series Shield Board is connected in MT Manager, the device description is shown in the “Device List” (Figure 5). To see a real time 3D orientation of the MTi click the 3D View icon . The inertial data , orientation data in Euler angles  and the status data  can be visualized by clicking their respective icons in Figure 5.

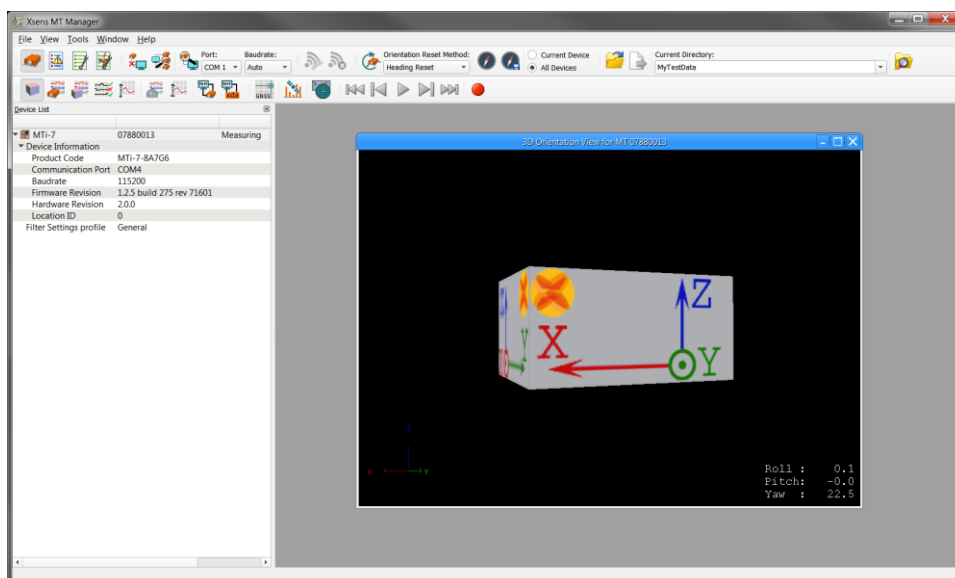



Figure 5: MT Manager overview

3.3 Configuring the MTi 1-series

The MTi-1s can be directly configured by means of MT Manager. Click the Output Configuration button  to open the Output Configuration dialog (Figure 6).

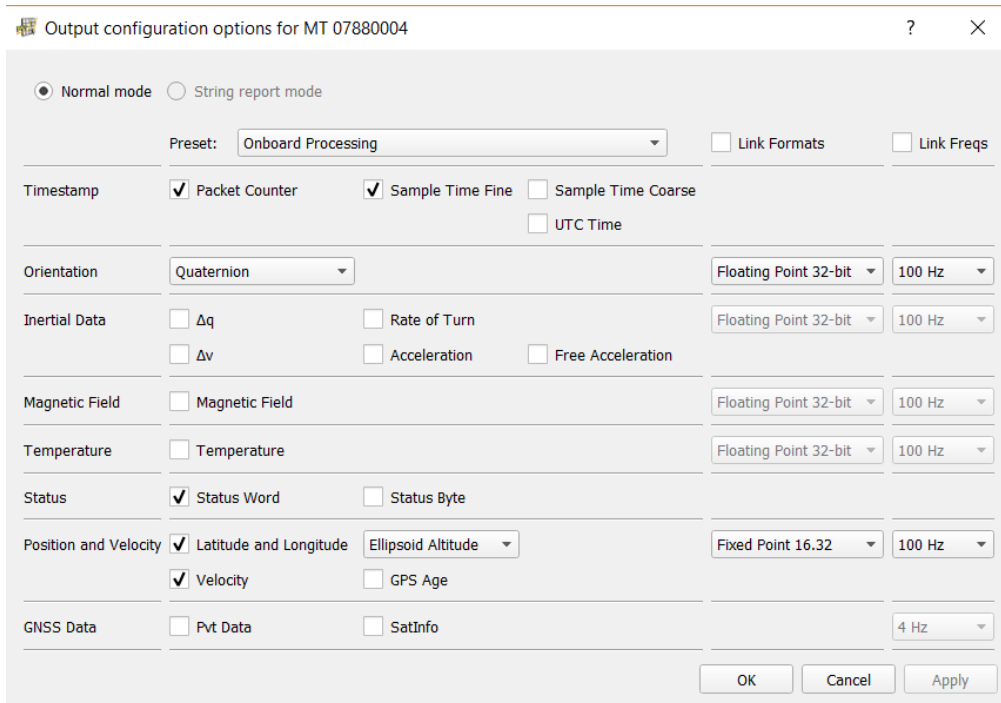

Figure 6: Output configuration dialog in MT Manager using an MTi-7-DK

By default, the output of the MTi-3 and MTi-7 is set to the 'Onboard Processing' preset, whereas the MTi-1 module is set to 'XDA processing' preset. Click "Inertial Data" ($\Delta q/\Delta v$ or Rate of Turn/Acceleration) and "Magnetic Field" to be able to show this data in MT Manager.

With MT Manager, it is possible to record data and export that data for use in other programs, set alignment matrices, configure synchronization options and to review the test and calibration report. More information on the functions and features can be found in the MT Manager User Manual. The MT Manager User Manual can be found via Help → Documentation.

4 Shield board

The MTi 1-s modules are available with a development kit. An MTi-3 AHRS or an MTi-7 external-GNSS/INS is mounted in a PLCC-28 socket and connected to USB, UART, I²C and SPI. The Shield Board exposes the pins of the MTi 1-s module making it easier for the user to test all the features and the peripherals offered by the MTi 1-s. This chapter discusses in more detail the connections and peripherals available on the MTi 1-s Shield Board.

4.1 Connections and peripheral switch

The MTi 1-series Shield Board has the following connections as shown in Figure 7:

- External power pin header (J100)
- Arduino-compatible headers (P100, P101, P102 and P103)
- UART communication extension socket, not placed by default (P202 and P203)
- Micro USB (J102)
- Peripheral selection switch (SW200)
- Auxiliary sensor extension socket (P200 and P201) used for GNSS daughter card
- MTi 1-series module placed in J101

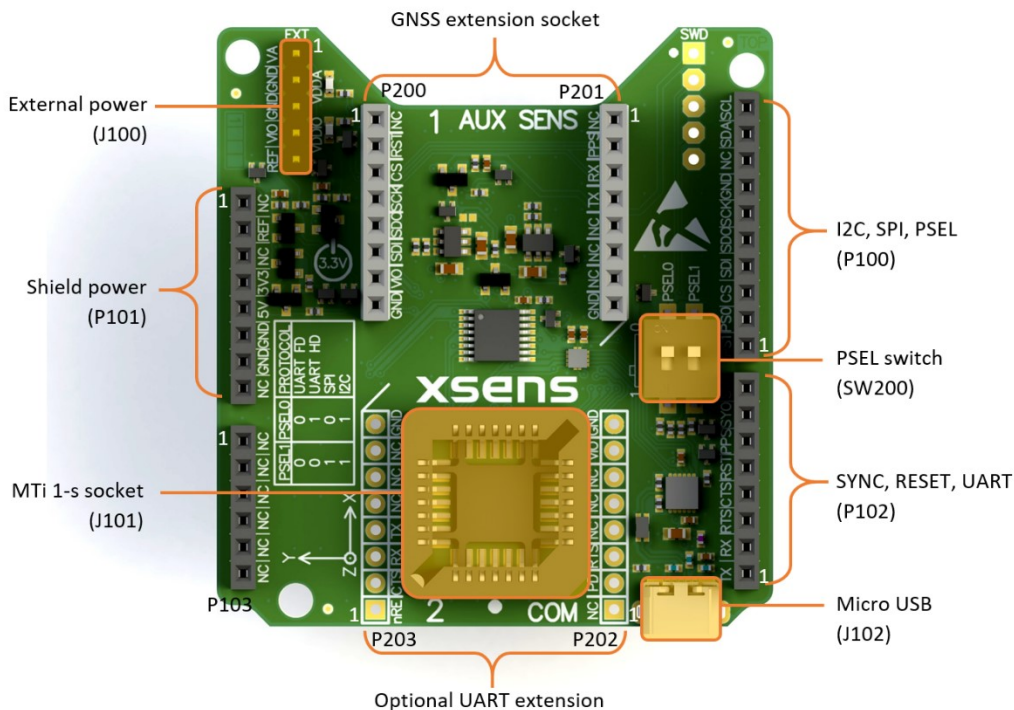

Figure 7: MTi 1-series Shield Board with connector designators

The *External power pin header* J100 can be used to directly supply the VDDIO and/or VDDA supplies for the MTi 1-s module (Table 3). The IOREF pin on this connector can be used to override the default 3.3 V VDDIO by placing a jumper from this pin to the adjacent VDDIO pin.

Table 3: Connections on external power header (J100 in Figure 7)

| Pin | Description |
|-----|-------------|
| 1 | VDDA |
| 2 | GND |
| 3 | GND |
| 4 | VDDIO |
| 5 | IOREF |

The connections for *Arduino-compatible headers* with a pitch of 2.54 mm (0.1 inch) are shown in Table 4. The MTi 1-series Shield Board does not support Arduino-compatible boards with an IOREF of 5V as the maximum VDDIO is 3.6V for the MTi 1-s module. Therefore, the VDDIO is by default set to 3.3V. This default VDDIO voltage can be overruled by placing a jumper on the external power header, but only for voltages within the operational VDDIO range of the MTi 1-s module. For information on the connections, refer to the pin description in Section 4.2. Refer to Table 6 on how to enable the various interfaces on the Shield Board.

Table 4: Connections on Arduino-compatible header (P100, P101, P102 and P103 in Figure 7)

| Pin | Arduino | Shield Board | Pin | Arduino | Shield Board |
|--------|---------|--------------|---------|----------|--------------|
| | | | P100-10 | SCL/D15 | SCL |
| | | | P100-9 | SDA/D14 | SDA |
| | | | P100-8 | AVDD | NC |
| P101-1 | NC | NC | P100-7 | GND | GND |
| P101-2 | IOREF | IOREF | P100-6 | SCK/D13 | SCK/ADD0 |
| P101-3 | NRST | NC | P100-5 | MISO/D12 | MISO/ADD1 |
| P101-4 | 3V3 | 3V3 | P100-4 | MOSI/D11 | MOSI/ADD2 |
| P101-5 | 5V | 5V | P100-3 | CS/D10 | nCS |
| P101-6 | GND | GND | P100-2 | D9 | PSEL0 |
| P101-7 | GND | GND | P100-1 | D8 | PSEL1 |
| P101-8 | VIN | NC | P102-8 | D7 | SYNC_IN |
| | | | P102-7 | D6 | SYNC_OUT |
| P103-1 | A0 | NC | P102-6 | D5 | SYNC_PPS |
| P103-2 | A1 | NC | P102-5 | D4 | RESET |
| P103-3 | A2 | NC | P102-4 | D3 | DRDY/CTS/nRE |
| P103-4 | A3 | NC | P102-3 | D2 | RTS/DE |
| P103-5 | A4 | NC | P102-2 | TX/D1 | RxD |
| P103-6 | A5 | NC | P102-1 | RX/D0 | TxD |

The *UART communication extension socket* is not placed by default. When the socket is placed, it can be used to directly plug an UART transceiver module of MikroElektronika like the 'RS232 click' or 'RS485

click 3.3V'. This UART communication extension socket uses (only) the 3.3V supply pin, which is connected to VDDIO. We recommend to place low profile sockets (like the *CES-108-01-T-S*) to make sure that the MTi 1-s module is still easily accessible. The pin description of these headers is shown in Table 5.

Table 5: Connections on UART communication extension sockets (P202 and P203 in Figure 7)

| Pin | Mikro BUS | MTi 1-s | Pin | Mikro BUS | MTi 1-s |
|--------|-----------|-----------|--------|-----------|--------------|
| P202-1 | AN | NC | P203-1 | PWM | DRDY/CTS/nRE |
| P202-2 | RST | Pull-down | P203-2 | INT | DRDY/CTS/nRE |
| P202-3 | CS | RTS/DE | P203-3 | TX | RxD |
| P202-4 | SCK | NC | P203-4 | RX | TxD |
| P202-5 | MISO | NC | P203-5 | SCL | NC |
| P202-6 | MOSI | NC | P203-6 | SDA | NC |
| P202-7 | 3.3V | VDDIO | P203-7 | 5V | NC |
| P202-8 | GND | GND | P203-8 | GND | GND |

The MTi 1-series Shield Board has a *Micro USB* connection that can be connected directly to a USB port on a PC or laptop. **Note:** Make sure to disconnect any other power supply, as this will overrule the USB connection.

The *Peripheral selection switch* sets the interface configuration of the MTi 1-s module in the socket. The switch connects the PSEL lines (Table 6) to GND with a 5 k Ω pull-down when set to ON. Otherwise, the PSEL lines are pulled-up with a 100 k Ω resistor. The PSEL pins on the Arduino-compatible headers can be used to overrule these lines.

Table 6: Switch positions to enable interfaces on Shield Board (SW200 in Figure 7)

| PSEL1 | PSEL0 | Interface | Comments |
|-------|-------|------------------|---|
| 0 | 0 | UART full-duplex | This interface uses the flow control lines RTS and CTS. The UART full-duplex communications mode can be used without hardware flow control. In this case the CTS line needs to be tied low (GND) to make the MTi device transmit. |
| 0 | 1 | UART half-duplex | The UART itself is still full duplex but the DE and nRE lines are used to control a half-duplex transceiver |
| 1 | 0 | SPI | |
| 1 | 1 | I ² C | When I ² C interface is selected, it is required to set the address on the Arduino-compatible headers (see MTi 1-series Data Sheet for the I ² C-addresses table) |

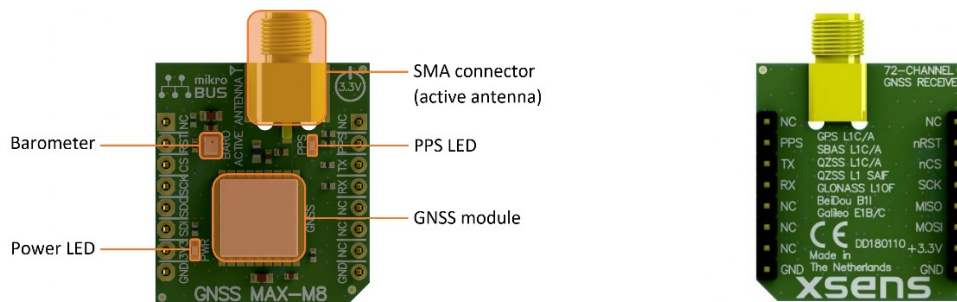

Figure 8: Top view (left) and the bottom view (right) of the GNSS daughter card

The MTi-7-DK comes with the GNSS daughter card installed in the *auxiliary sensor extension sockets* (P200 and P201). As shown in Figure 8, the GNSS daughter card consists of a GNSS and a barometer sensor component. The LEDs (Power and PPS) give indication of proper functioning of the GNSS daughter card. The supplied GNSS antenna can be connected to the SMA connector.

The *auxiliary sensor extension socket* has mikroBUS™ compatible pinning. This enables the user to connect alternate GNSS daughter card modules with mikroBUS™ pinning to the MTi 1-series Shield board. The pinning connections for the auxiliary sensor extension socket are listed in Table 7. This extension only uses the 3.3V supply pin, which is connected to VDDIO. Therefore, make sure that the VDDIO is within the required voltage range of the GNSS module.

Table 7: Connections on auxiliary sensor extension sockets (P200 and P201 in Figure 7)

| Pin | Mikro BUS | MTi 1-s | Pin | Mikro BUS | MTi 1-s |
|--------|-----------|----------|--------|-----------|----------|
| P200-1 | AN | NC | P201-1 | PWM | NC |
| P200-2 | RST | nRST | P201-2 | INT | SYNC_PPS |
| P200-3 | CS | AUX_nCS | P201-3 | TX | AUX_RxD |
| P200-4 | SCK | AUX_SCK | P201-4 | RX | AUX_TxD |
| P200-5 | MISO | AUX_MISO | P201-5 | SCL | NC |
| P200-6 | MOSI | AUX_MOSI | P201-6 | SDA | NC |
| P200-7 | 3.3V | VDDIO | P201-7 | 5V | NC |
| P200-8 | GND | GND | P201-8 | GND | GND |



4.2 Pin descriptions

Table 8: Pin descriptions Shield Board

| Name | Type | Description |
|-----------------------------|--------------------------|--|
| Power Interface | | |
| VDDA | Power | Power supply voltage for sensing elements |
| VDDIO | Power | Digital I/O supply voltage |
| Controls | | |
| PSEL0 | Selection pins | These pins determine the signal interface. Note that when the PSEL0/PSEL1 is not connected, its logic value is 1. When PSEL0/PSEL1 is connected to GND, its logic value is 0 |
| PSEL1 | | |
| RESET | | Active high reset pin, connect to GND if not used |
| Peripheral Interface | | |
| SDA | I2C interface | I2C serial data |
| SCL | | I2C serial clock |
| ADD[0..2] | | I2C address selection pins |
| nCS | SPI interface | SPI chip select |
| MOSI | | SPI serial data input (slave) |
| MISO | | SPI serial data output (slave) |
| SCK | | SPI serial clock |
| RTS | UART interface | Hardware flow control in UART full-duplex mode (Ready-to-Send) |
| CTS | | Hardware flow control in UART full-duplex mode (Clear-to-Send) |
| nRE | | Receiver control signal in UART half-duplex mode |
| DE | | Transmitter control signal in UART half-duplex mode |
| RxD | | Receiver data input |
| TxD | | Transmitter data output |
| DRDY | Data ready | Data ready pin indicates that data is available (SPI / I2C) |
| SYNC_IN | Sync interface | Accepts a trigger input to request the latest available data message |
| SYNC_OUT | | N/A |
| SYNC_PPS | | Pulse Per Second output of GNSS module |
| AUX_RxD | Auxiliary UART interface | Auxiliary UART data input |
| AUX_TxD | | Auxiliary UART data output |
| AUX_nCS | Auxiliary SPI interface | Auxiliary SPI chip select |
| AUX_MOSI | | Auxiliary SPI serial data output (master) |
| AUX_MISO | | Auxiliary SPI serial data input (master) |
| AUX_SCK | | Auxiliary SPI serial clock |

4.3 Electrical specifications

The Shield Board has the same communication protocol as the MTi 1-s module. Table 9 shows the electrical specifications for the Shield Board.

Table 9: System specification Shield Board

| | | Min | Typ | Max | Unit |
|-----------------|-----------------|--------------|-----|--------------|------|
| VDDA | | 2.16 | 3.3 | 3.6 | V |
| VDDIO | | 1.8 | 3.3 | 3.6 | V |
| V _{IO} | V _{IH} | 0.75 * VDDIO | | | V |
| | V _{IL} | | | 0.25 * VDDIO | V |

4.4 Absolute maximum ratings

Table 10: Absolute maximum ratings Shield Board

| Parameter | Min | Max | Unit | Comments |
|---|------|-------------|------|---|
| Storage temperature | -50 | +125 | °C | |
| Operating temperature | -40 | +85 | °C | |
| VDD | -0.3 | 4.0 | V | Specification for the external power header J100. |
| 5V on P101 and J102 | -0.3 | 6.0 | V | Specification for the Arduino and USB. |
| VDDIO | -0.3 | 4.0 | V | Specification for the external power header J100. |
| V _{UART, PSEL, I²C} | -0.3 | VDDIO + 0.3 | V | |
| V _{RESET, SYNC, SPI} | -0.3 | VDDIO + 4.0 | V | |
| Acceleration ⁴ | | 10,000 | g | Any axis, unpowered, for 0.2 ms |
| ESD protection ⁵ | | ±2000 | V | Human body model |

Stresses beyond those listed under “Absolute Maximum Ratings” may cause permanent damage to the device. These are stress ratings only. Functional operation of the device at these or any other conditions beyond those indicated in the operational sections of the specifications is not implied. Exposure to absolute maximum rating conditions for extended periods may affect device reliability. Make sure not to apply force on the components of the MTi 1-s module, especially when placing the MTi 1-s module in a PLCC socket.

⁴ Δ This is a mechanical shock (g) sensitive device. Proper handling is required to prevent damage to the part.

⁵ \blacklightning This is an ESD-sensitive device. Proper handling is required to prevent damage to the part.

4.5 Package drawing

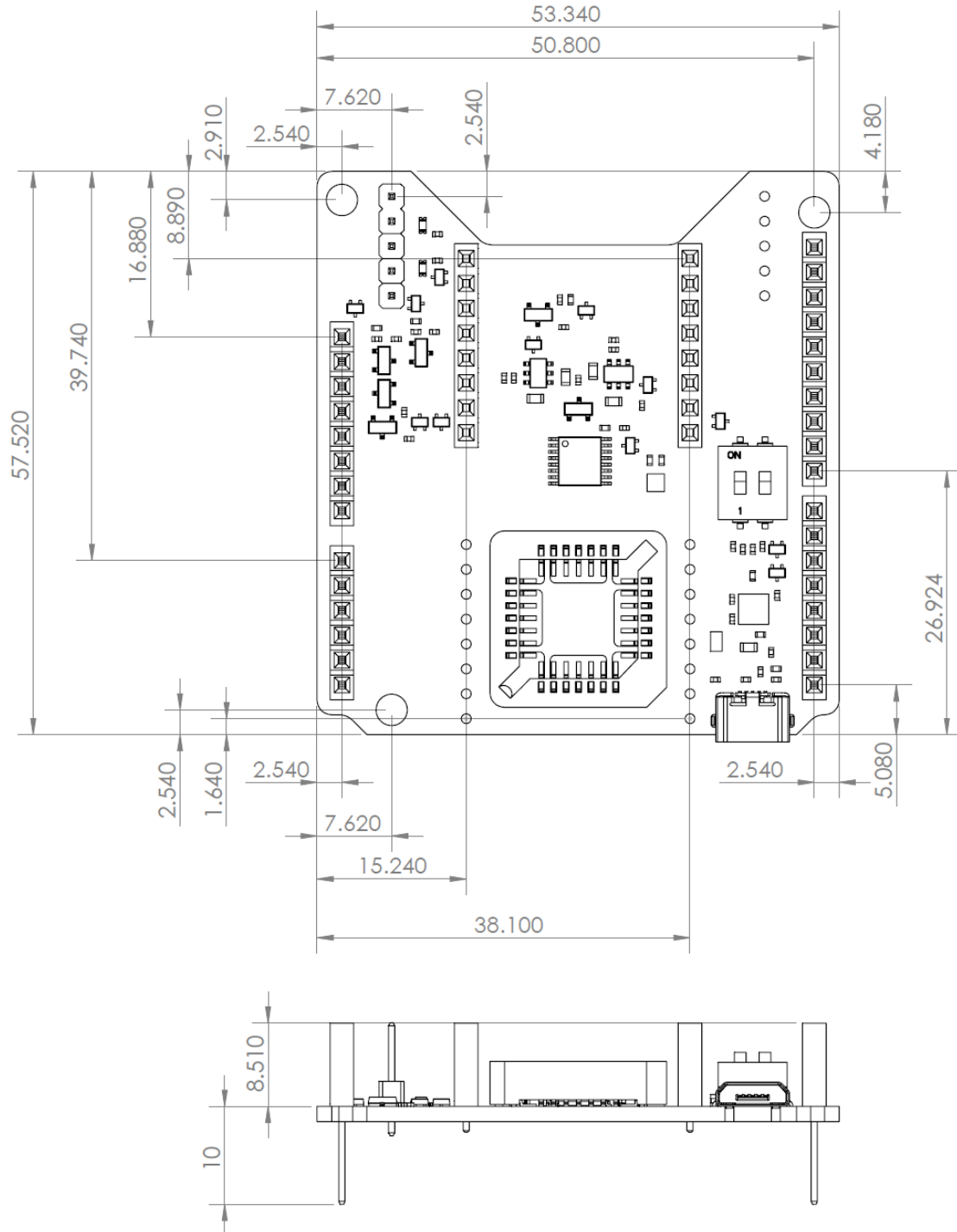

Figure 9: MTi 1-series Shield Board package drawing (Top and Side view)