



POWER SUPPLY

- AC 100-240V Wide-range Input
- Width only 65mm
- Efficiency up to 94.3%
- ATEX and IECEx Approved
- Excellent Partial Load Efficiency
- 20% Output Power Reserves
- Safe Hiccup^{PLUS} Overload Mode
- Easy Fuse Breaking due to High Overload Current (typ. 45A for 15ms)
- Active Power Factor Correction (PFC)
- Minimal Inrush Current Surge
- Full Power Between -25°C and +60°C
- DC-OK Relay Contact
- Current Sharing Feature for Parallel Use
- 3 Year Warranty

GENERAL DESCRIPTION

The Dimension C-Series are cost optimized power supplies without compromising quality, reliability and performance. The C-Series is part of the DIMENSION power supply family. The most outstanding features of CPS20.361 are the high efficiency, electronic inrush current limitation, active PFC, wide operational temperature range. The small size is achieved by a synchronous rectification and further technological design details.

The C-Series includes all the essential basic functions. The devices have a power reserve of 20% included, which may even be used continuously at temperatures up to +45°C. Additionally, the CPS20.361 can deliver about 3.5 times the nominal output current for 15ms which helps to trip fuses on faulty output branches.

High immunity to transients and power surges as well as low electromagnetic emission, a DC-OK relay contact and a large international approval package for a variety of applications makes this unit suitable for nearly every situation.

SHORT-FORM DATA

Output voltage	DC 36V	
Adjustment range	36 - 42V	
Output current	13.3A	at 36V, amb <60°C
	16A	at 36V, amb <45°C
	11.4A	at 42V, amb <60°C
	13.7A	at 42V, amb <45°C
Output power	480W	ambient <60°C
	576W	ambient <45°C
Output ripple	< 100mVpp	20Hz to 20MHz
AC Input voltage	AC 100-240V	-15%/+10%
Mains frequency	50-60Hz	±6%
AC Input current	4.36 / 2.33A	at 120 / 230Vac
Power factor	0.99 / 0.95	at 120 / 230Vac
AC Inrush current	typ. 9 / 7A peak	at 120 / 230Vac
Efficiency	93.0 / 94.3%	at 120 / 230Vac
Losses	36.1 / 29.0W	at 120 / 230Vac
Temperature range	-25°C to +70°C	operational
	Derating *)	+60 to +70°C
Hold-up time	typ. 26 / 26ms	at 120 / 230Vac
Dimensions	65x124x127mm	WxHxD
	1000g / 2.2lb	1000g / 2.2lb

*) between 100-85Vac see chapter 15

ORDER NUMBERS

Power Supply	CPS20.361	36-42V Standard unit
Accessory	ZM2.WALL	Wall mount bracket
	ZM13.SIDE	Side mount bracket
	YR40.482	Redundancy module

MARKINGS



INDEX

	Page		Page
1. Intended Use	3	20. Physical Dimensions and Weight	18
2. Installation Requirements.....	3	21. Accessories	19
3. AC-Input.....	4	21.1. ZM2.WALL - Wall Mounting Bracket.....	19
4. DC-Input.....	5	21.2. ZM13.SIDE - Side Mounting Bracket.....	19
5. Input Inrush Current	5	21.3. Redundancy Modules	20
6. Output	6	22. Application Notes.....	21
7. Hold-up Time.....	8	22.1. Peak Current Capability	21
8. DC-OK Relay Contact	8	22.2. Back-feeding Loads	21
9. Efficiency and Power Losses.....	9	22.3. External Input Protection.....	22
10. Lifetime Expectancy and MTBF.....	10	22.4. Output Circuit Breakers.....	22
11. Functional Diagram.....	10	22.5. Parallel Use to Increase Output Power....	23
12. Terminals and Wiring.....	11	22.6. Parallel Use for Redundancy	23
13. Front Side and User Elements.....	12	22.7. Series Operation	24
14. EMC.....	13	22.8. Inductive and Capacitive Loads.....	24
15. Environment.....	14	22.9. Charging of Batteries	24
16. Protection Features	15	22.10. Operation on Two Phases	25
17. Safety Features	15	22.11. Use in a Tightly Sealed Enclosure	25
18. Dielectric Strength	16	22.12. Mounting Orientations	26
19. Approvals.....	17		

The information presented in this document is believed to be accurate and reliable and may change without notice. No part of this document may be reproduced or utilized in any form without permission in writing from the publisher.

TERMINOLOGY AND ABBREVIATIONS

PE and \oplus symbol	PE is the abbreviation for Protective Earth and has the same meaning as the symbol \oplus .
Earth, Ground	This document uses the term "earth" which is the same as the U.S. term "ground".
T.b.d.	To be defined, value or description will follow later.
AC 230V	A figure displayed with the AC or DC before the value represents a nominal voltage with standard tolerances (usually $\pm 15\%$) included. E.g.: DC 12V describes a 12V battery disregarding whether it is full (13.7V) or flat (10V)
230Vac	A figure with the unit (Vac) at the end is a momentary figure without any additional tolerances included.
50Hz vs. 60Hz	As long as not otherwise stated, AC 230V parameters are valid at 50Hz mains frequency.
may	A key word indicating flexibility of choice with no implied preference.
shall	A key word indicating a mandatory requirement.
should	A key word indicating flexibility of choice with a strongly preferred implementation.

1. INTENDED USE

This device is designed for installation in an enclosure and is intended for the general professional use such as in industrial control, office, communication, and instrumentation equipment.

Do not use this power supply in equipment, where malfunction may cause severe personal injury or threaten human life.

This device is designed for use in hazardous, non-hazardous, ordinary or unclassified locations.

2. INSTALLATION REQUIREMENTS

This device may only be installed and put into operation by qualified personnel.

This device does not contain serviceable parts. The tripping of an internal fuse is caused by an internal defect.

If damage or malfunction should occur during installation or operation, immediately turn power off and send unit to the factory for inspection.

Mount the unit on a DIN-rail so that the terminals are located on the bottom of the unit. For other mounting orientations see de-rating requirements in this document. See chapter 24.13.

This device is designed for convection cooling and does not require an external fan. Do not obstruct airflow and do not cover ventilation grid (e.g. cable conduits) by more than 15%!

Keep the following installation clearances: 40mm on top, 20mm on the bottom, 5mm on the left and right sides are recommended when the device is loaded permanently with more than 50% of the rated power. Increase this clearance to 15mm in case the adjacent device is a heat source (e.g. another power supply).

A disconnecting means shall be provided for the output of the power supplies when used in applications according to CSA C22.2 No 107.1-01.

⚠ WARNING Risk of electrical shock, fire, personal injury or death.

- Do not use the power supply without proper grounding (Protective Earth). Use the terminal on the input block for earth connection and not one of the screws on the housing.
- Turn power off before working on the device. Protect against inadvertent re-powering.
- Make sure that the wiring is correct by following all local and national codes.
- Do not modify or repair the unit.
- Do not open the unit as high voltages are present inside.
- Use caution to prevent any foreign objects from entering the housing.
- Do not use in wet locations or in areas where moisture or condensation can be expected.
- Do not touch during power-on, and immediately after power-off. Hot surfaces may cause burns.

Notes for use in hazardous location areas:

The power supply is suitable for use in Class I Division 2 Groups A, B, C, D locations and for use in Group II Category 3 (Zone 2) environments and are evaluated according to EN 60079-0:2012 and EN 60079-15:2010.

WARNING EXPLOSION HAZARDS!

Substitution of components may impair suitability for this environment. Do not disconnect the unit or operate the voltage adjustment or S/P jumper unless power has been switched off or the area is known to be non-hazardous.

A suitable enclosure must be provided for the end product which has a minimum protection of IP54 and fulfils the requirements of the EN 60079-15:2010.

3. AC-INPUT

AC input	nom.	AC 100-240V	suitable for TN-, TT- and IT mains networks
AC input range	min.	100-264Vac	continuous operation
	min.	85-100Vac	short term or with output derating (1%/V) or with reduced ambient temperature, see Fig. 15-1, no damage between 0 and 85Vac
	min.	264-300Vac	< 500ms
Allowed voltage L or N to earth	max.	300Vac	continuous, IEC 62103
Input frequency	nom.	50–60Hz	±6%
Turn-on voltage	typ.	84Vac	steady-state value, see Fig. 3-1
Shut-down voltage	typ.	39Vac	steady-state value at 3.3A load, see Fig. 3-1
	typ.	53Vac	steady-state value at 6.7A load, see Fig. 3-1
	typ.	74Vac	steady-state value at 13.3A load, see Fig. 3-1

		AC 100V	AC 120V	AC 230V	
Input current	typ.	5.25A	4.36A	2.33A	at 36V, 13.3A, see Fig. 3-3
		6.33A	5.23A	2.8A	at 36V, 16A, see Fig. 3-3
Power factor ^{*)}	typ.	0.99	0.99	0.95	at 36V, 13.3A, see Fig. 3-4
Crest factor ^{**)}	typ.	1.5	1.5	1.65	at 36V, 13.3A
Start-up delay	typ.	900ms	850ms	700ms	see Fig. 3-2
Rise time	typ.	90ms	90ms	90ms	at 36V, 13.3A const. current load, 0mF load capacitance, see Fig. 3-2
	typ.	200ms	200ms	200ms	at 36V, 13.3A const. current load, 15mF load capacitance, see Fig. 3-2
Turn-on overshoot	max.	1V	1V	1V	see Fig. 3-2

*) The power factor is the ratio of the true (or real) power to the apparent power in an AC circuit.

***) The crest factor is the mathematical ratio of the peak value to RMS value of the input current waveform.

Fig. 3-1 Input voltage range

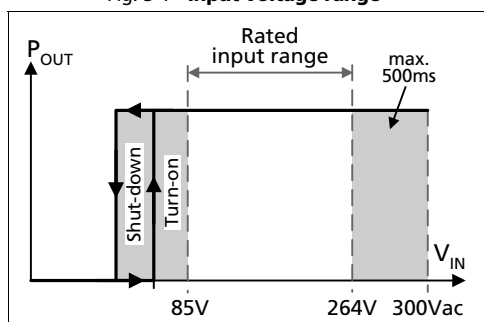

Fig. 3-2 Turn-on behavior, definitions

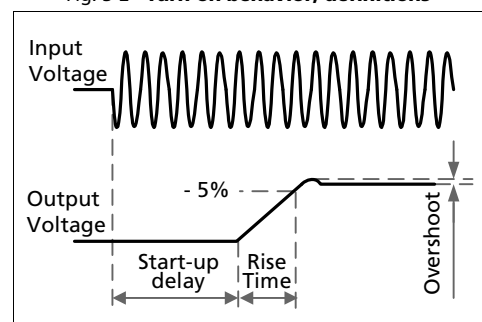

Fig. 3-3 Input current vs. output current

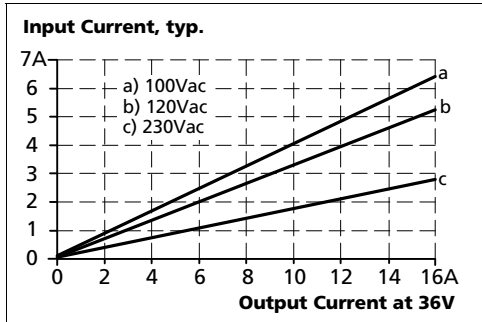
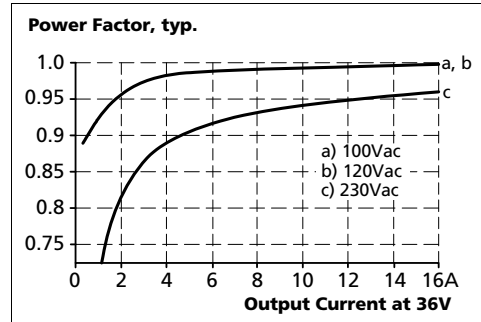

Fig. 3-4 Power factor vs. output current



4. DC-INPUT

Do not operate this power supply with DC-input voltage.

5. INPUT INRUSH CURRENT

An active inrush limitation circuit limits the input inrush current after turn-on of the input voltage and after short input voltage interruptions.

The charging current into EMI suppression capacitors is disregarded in the first microseconds after switch-on.

		AC 100V	AC 120V	AC 230V	
Inrush current ^{*)}	max.	13A _{peak}	13A _{peak}	13A _{peak}	temperature independent
	typ.	11A _{peak}	9A _{peak}	7A _{peak}	temperature independent
Inrush energy ^{*)}	max.	2A ² s	2.5A ² s	0.5A ² s	temperature independent

*) Mains interruptions > 500ms

Fig. 5-1 Typical input inrush current behaviour at nominal load and 25°C ambient

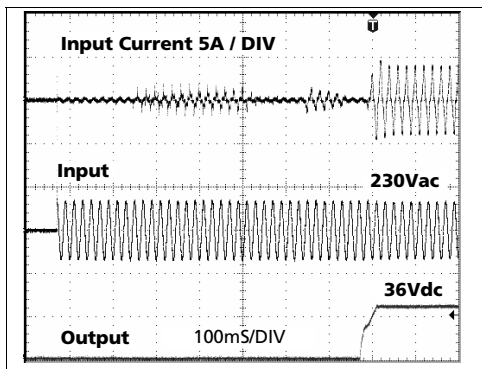

6. OUTPUT

Output voltage	nom.	36V	
Adjustment range	min.	36-42V	guaranteed
	max.	44V ^{****)}	at clockwise end position of potentiometer
Factory settings	typ.	36.0V	±0.2%, at full load, cold unit, in "single use" mode
	typ.	36.0V	±0.2%, at full load, cold unit, in "parallel use" mode
	typ.	37.5V	at no load, cold unit, in "parallel use" mode
Line regulation	max.	10mV	85-300Vac
Load regulation	max.	150mV	in "single use" mode: static value, 0A → 13.3A; see Fig. 6-1
	typ.	1500mV	in "parallel use" mode: static value, 0A → 13.3A, see Fig. 6-2
Ripple and noise voltage	max.	100mVpp	20Hz to 20MHz, 50Ohm
Output current	nom.	13.3A	at 36V, ambient temperature <60°C, see Fig. 6-1
	nom.	16A ^{*)}	at 36V, ambient temperature <45°C, see Fig. 6-1
	nom.	11.4A	at 42V, ambient temperature <60°C, see Fig. 6-1
	nom.	13.7A ^{*)}	at 42V, ambient temperature <45°C, see Fig. 6-1
	typ.	45A	up to 15ms, output voltage stays above 30V, see Fig. 6-4, This peak current is available once every five seconds. See chapter 22.1 for more peak current measurements.
Output power	nom.	480W	continuously available
	nom.	576W ^{*)}	Power Boost ^{*)}
Overload behaviour		cont. current	output voltage > 20Vdc, see Fig. 6-1
		Hiccup ^{PLUS} mode ^{**)}	output voltage < 20Vdc, see Fig. 6-1
Short-circuit current	min.	22A ^{***)}	load impedance <10mOhm, see Fig. 6-3
	max.	30A ^{***)}	load impedance <10mOhm, see Fig. 6-3
	max.	9.5A ^{***)}	average (R.M.S.) current, load impedance 50mOhm, see Fig. 6-3
	min.	45A	up to 15ms, load impedance <10mOhm, see Fig. 6-4
	typ.	52A	up to 15ms, load impedance <10mOhm, see Fig. 6-4
Output capacitance	typ.	3 800µF	included inside the power supply

***) Power Boost**

This power/ current is continuously allowed up to an ambient temperature of 45°C. Above 45°C, do not use this power/ current longer than a duty cycle of 10% and/ or not longer than 1 minute every 10 minutes.

*****) Hiccup^{PLUS} Mode**

At heavy overloads (when output voltage falls below 20V), the power supply delivers continuous output current for 2s. After this, the output is switched off for approx. 18s before a new start attempt is automatically performed. This cycle is repeated as long as the overload exists. If the overload has been cleared, the device will operate normally. See Fig. 6-3.

******)** Discharge current of output capacitors is not included.

*******)** This is the maximum output voltage which can occur at the clockwise end position of the potentiometer due to tolerances. It is not guaranteed value which can be achieved. The typical value is about 42.7V (in "single use" mode).

Fig. 6-1 **Output voltage vs. output current, typ.**

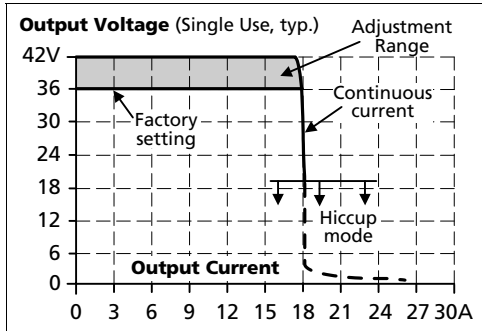

Fig. 6-2 **Output voltage in "parallel use" mode, typ.**

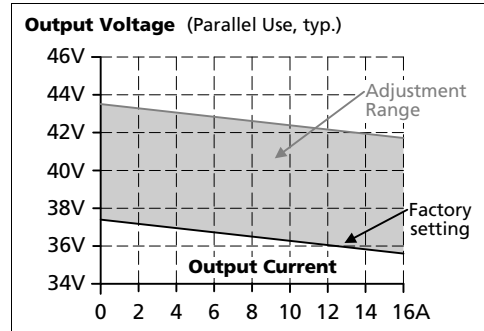

Fig. 6-3 **Short-circuit on output, Hiccup^{plus} mode, typ.**

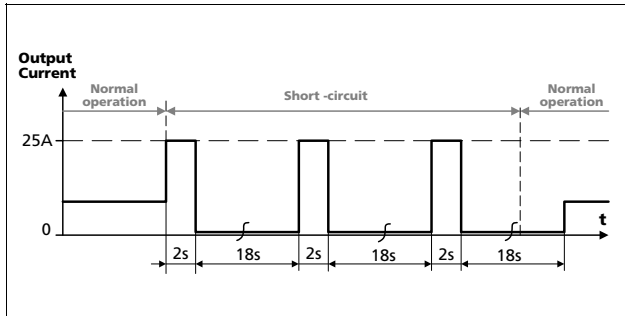
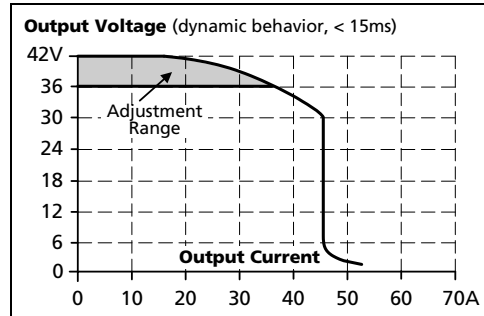

Fig. 6-4 **Dynamic overcurrent capability, typ.**



7. HOLD-UP TIME

		AC 100V	AC 120V	AC 230V	
Hold-up Time	typ.	65ms	65ms	65ms	at 36V, 6.7A, see Fig. 7-1
	min.	54ms	54ms	54ms	at 36V, 6.7A, see Fig. 7-1
	typ.	26ms	26ms	26ms	at 36V, 13.3A, see Fig. 7-1
	min.	21ms	21ms	21ms	at 36V, 13.3A, see Fig. 7-1

Fig. 7-1 Hold-up time vs. input voltage

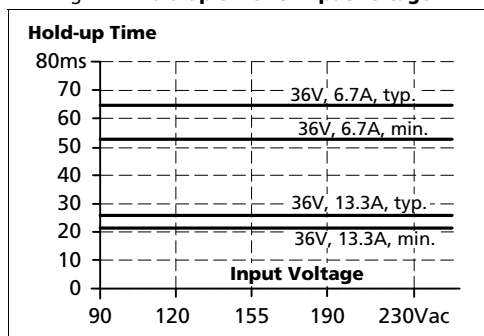
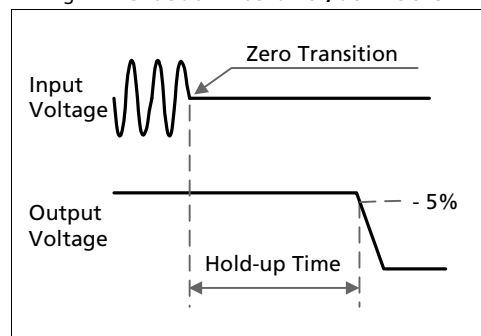

Fig. 7-2 Shut-down behavior, definitions



8. DC-OK RELAY CONTACT

This feature monitors the output voltage, which is produced by the power supply itself. It is independent of a back-fed voltage from a unit connected in parallel to the power supply output.

Contact closes	As soon as the output voltage reaches 90% of the adjusted output voltage level.		
Contact opens	As soon as the output voltage dips more than 10% below the adjusted output voltage. Short dips will be extended to a signal length of 100ms. Dips shorter than 1ms will be ignored.		
Contact ratings	max.	60Vdc 0.3A, 30Vdc 1A, 30Vac 0.5A	resistive load
	min.	1mA at 5Vdc	min. permissible load
Isolation voltage	See dielectric strength table in section 18.		

Fig. 8-1 DC-ok relay contact behavior

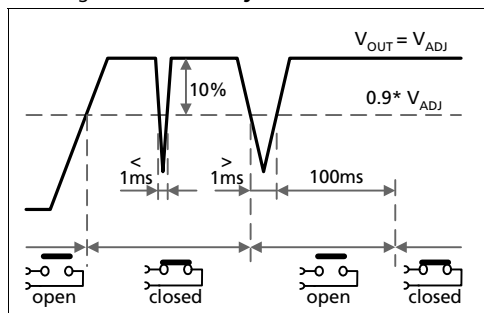

9. EFFICIENCY AND POWER LOSSES

		AC 100V	AC 120V	AC 230V	
Efficiency	typ.	92.4%	93.0%	94.3%	at 36V, 13.3A
	typ.	91.9%	92.7%	94.1%	at 36V, 16A (Power Boost)
Average efficiency*)	typ.	91.4%	91.8%	93.2%	25% at 3.3A, 25% at 6.7A, 25% at 10A, 25% at 13.3A
Power losses	typ.	6.8W	5.8W	2.8W	at 36V, 0A
	typ.	21.0W	20.0W	16.5W	at 36V, 6.7A (=50%)
	typ.	39.5W	36.1W	29.0W	at 36V, 13.3A
	typ.	50.8W	45.4W	36.1W	at 36V, 16A (Power Boost)

*) The average efficiency is an assumption for a typical application where the power supply is loaded with 25% of the nominal load for 25% of the time, 50% of the nominal load for another 25% of the time, 75% of the nominal load for another 25% of the time and with 100% of the nominal load for the rest of the time.

Fig. 9-1 Efficiency vs. output current at 36V, typ.

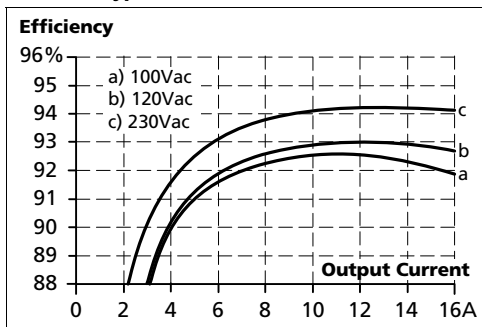

Fig. 9-2 Losses vs. output current at 36V, typ.

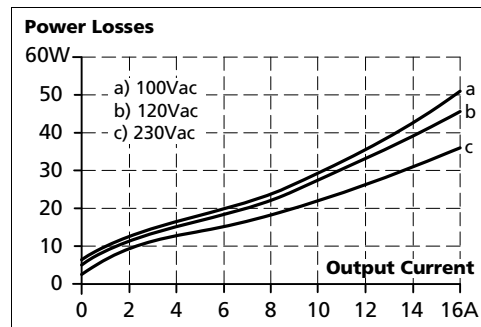

Fig. 9-3 Efficiency vs. input voltage at 36V, 13.3A, typ.

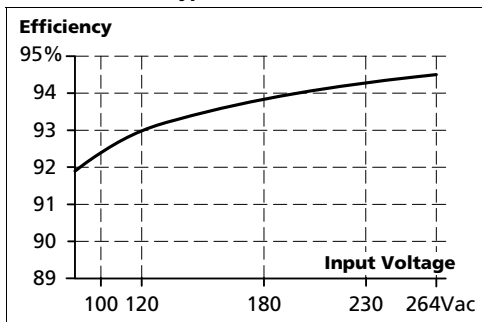
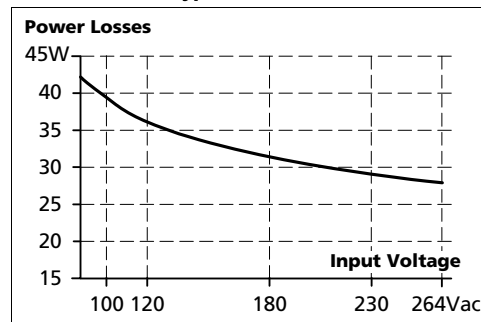

Fig. 9-4 Losses vs. input voltage at 36V, 13.3A, typ.



10. LIFETIME EXPECTANCY AND MTBF

	AC 100V	AC 120V	AC 230V	
Lifetime expectancy*)	153 000h*)	162 000h*)	183 000h*)	at 36V, 6.7A and 40°C
	434 000h*)	459 000h*)	516 000h*)	at 36V, 6.7A and 25°C
	77 000h	85 000h	101 000h	at 36V, 13.3A and 40°C
	219 000h*)	239 000h*)	286 000h*)	at 36V, 13.3A and 25°C
	52 000h	58 000h	75 000h	at 36V, 16A and 40°C
	146 000h*)	164 000h*)	211 000h*)	at 36V, 16A and 25°C
MTBF**) SN 29500, IEC 61709	468 000h	484 000h	537 000h	at 36V, 13.3A and 40°C
	770 000h	796 000h	882 000h	at 36V, 13.3A and 25°C
MTBF**) MIL HDBK 217F	254 000h	261 000h	290 000h	at 36V, 13.3A and 40°C; Ground Benign GB40
	355 000h	361 000h	395 000h	at 36V, 13.3A and 25°C; Ground Benign GB25
	56 000h	57 000h	64 000h	at 36V, 13.3A and 40°C; Ground Fixed GF40
	75 000h	77 000h	86 000h	at 36V, 13.3A and 25°C; Ground Fixed GF25

- *) The **Lifetime expectancy** shown in the table indicates the minimum operating hours (service life) and is determined by the lifetime expectancy of the built-in electrolytic capacitors. Lifetime expectancy is specified in operational hours and is calculated according to the capacitor's manufacturer specification. The manufacturer of the electrolytic capacitors only guarantees a maximum life of up to 15 years (131 400h). Any number exceeding this value is a calculated theoretical lifetime which can be used to compare devices.
- **) **MTBF** stands for **Mean Time Between Failure**, which is calculated according to statistical device failures, and indicates reliability of a device. It is the statistical representation of the likelihood of a unit to fail and does not necessarily represent the life of a product. The MTBF figure is a statistical representation of the likelihood of a device to fail. A MTBF figure of e.g. 1 000 000h means that statistically one unit will fail every 100 hours if 10 000 units are installed in the field. However, it can not be determined if the failed unit has been running for 50 000h or only for 100h.

11. FUNCTIONAL DIAGRAM

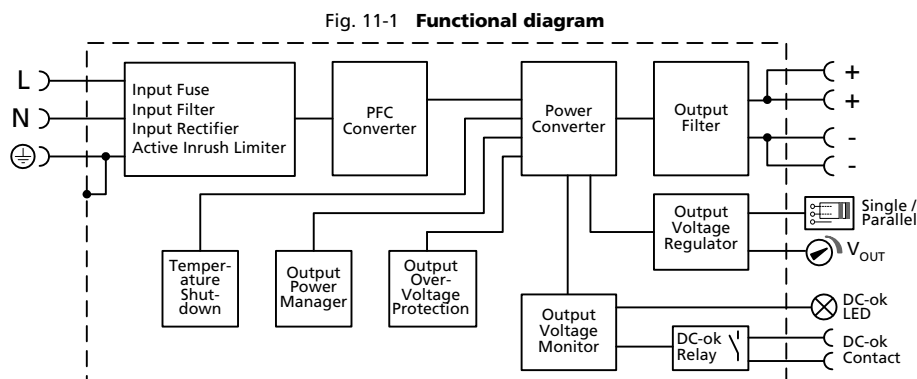

12. TERMINALS AND WIRING

The terminals are IP20 Finger safe constructed and suitable for field- and factory wiring.

	Input and output	DC-OK-Signal
Type	screw terminals	spring-clamp terminals
Solid wire	0.5-6mm ²	0.15-1.5mm ²
Stranded wire	0.5-4mm ²	0.15-1.5mm ²
American Wire Gauge	AWG20-10	AWG26-14
Max. wire diameter	2.8mm (including ferrules)	1.5mm (including ferrules)
Wire stripping length	7mm / 0.28inch	7mm / 0.28inch
Screwdriver	3.5mm slotted or cross-head No 2	3.5mm slotted (to open the spring)
Recommended tightening torque	1Nm, 9lb.in	not applicable

Instructions:

- Use appropriate copper cables that are designed for minimum operating temperatures of:
60°C for ambient up to 45°C and
75°C for ambient up to 60°C minimum
90°C for ambient up to 70°C minimum.
- Follow national installation codes and installation regulations!
- Ensure that all strands of a stranded wire enter the terminal connection!
- Do not use the unit without PE connection.
- Unused terminal compartments should be securely tightened.
- Ferrules are allowed.

Daisy chaining:

Daisy chaining (jumping from one power supply output to the next) is allowed as long as the average output current through one terminal pin does not exceed 25A. If the current is higher, use a separate distribution terminal block as shown in Fig. 12-2.

Fig. 12-1 Daisy chaining of outputs

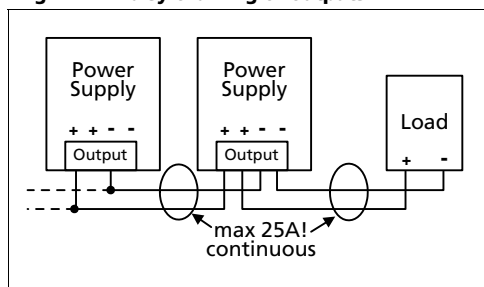
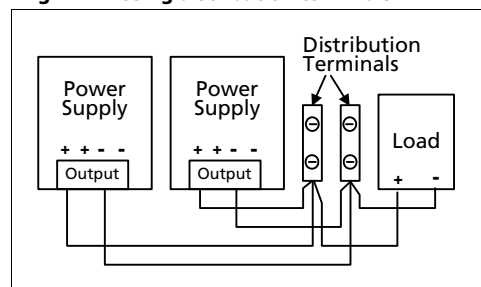
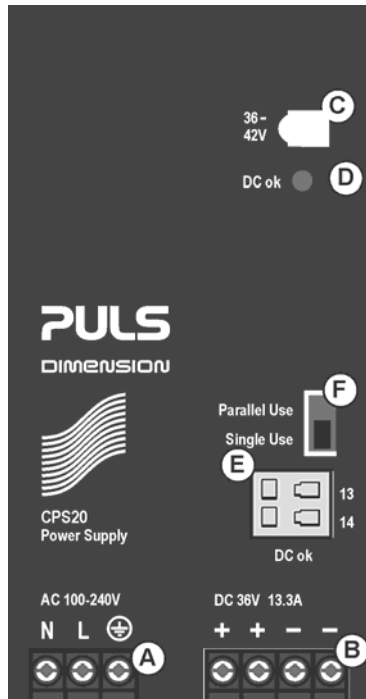

Fig. 12-2 Using distribution terminals



13. FRONT SIDE AND USER ELEMENTS

Fig. 13-1 Front side



A Input Terminals (screw terminals)

- N, L** Line input
- ⊕ PE (Protective Earth) input

B Output Terminals (screw terminals, two pins per pole)

- +** Positive output
- Negative (return) output

C Output voltage potentiometer

Open the flap to adjust the output voltage. Factory set: 36.0V

D DC-OK LED (green)

On, when the output voltage is >90% of the adjusted output voltage

E DC-OK Relay Contact (quick-connect spring-clamp terminals)

The DC-OK relay contact is synchronized with the DC-OK LED. See chapter 8 for details.

F "Parallel Use" "Single Use" selector

Set jumper to "Parallel Use" when power supplies are connected in parallel to increase the output power. In order to achieve a sharing of the load current between the individual power supplies, the "parallel use" regulates the output voltage in such a manner that the voltage at no load is approx. 4% higher than at nominal load. See also chapter 22.5. A missing jumper is equal to a "Single Use" mode.

14. EMC

The power supply is suitable for applications in industrial environment as well as in residential, commercial and light industry environment without any restrictions. A detailed EMC report is available on request.

EMC Immunity		According generic standards: EN 61000-6-1 and EN 61000-6-2		
Electrostatic discharge	EN 61000-4-2	contact discharge air discharge	8kV 15kV	Criterion A Criterion A
Electromagnetic RF field	EN 61000-4-3	80MHz-2.7GHz	20V/m	Criterion A
Fast transients (Burst)	EN 61000-4-4	input lines output lines DC-OK signal (coupling clamp)	4kV 2kV 2kV	Criterion A Criterion A Criterion A
Surge voltage on input	EN 61000-4-5	L → N L → PE, N → PE	2kV 4kV	Criterion A Criterion A
Surge voltage on output	EN 61000-4-5	+ → - + / - → PE	1kV 2kV	Criterion A Criterion A
Surge voltage on DC-OK	EN 61000-4-5	DC-OK signal → PE	1kV	Criterion A
Conducted disturbance	EN 61000-4-6	0.15-80MHz	20V	Criterion A
Mains voltage dips	EN 61000-4-11	0% of 100Vac 40% of 100Vac 70% of 100Vac 0% of 200Vac 40% of 200Vac 70% of 200Vac	0Vac, 20ms 40Vac, 200ms 70Vac, 500ms 0Vac, 20ms 80Vac, 200ms 140Vac, 500ms	Criterion A Criterion C Criterion A Criterion A Criterion A Criterion A
Voltage interruptions	EN 61000-4-11	0% of 200Vac (=0V)	5000ms	Criterion C
Voltage sags	SEMI F47 0706	dips on the input voltage according to SEMI F47 standard 80% of 120Vac (96Vac) 70% of 120Vac (84Vac) 50% of 120Vac (60Vac)	1000ms 500ms 200ms	Criterion A Criterion A Criterion A
Powerful transients	VDE 0160	over entire load range	750V, 1.3ms	Criterion A

Criteria:

- A:** Power supply shows normal operation behavior within the defined limits.
- C:** Temporary loss of function is possible. Power supply may shut-down and restarts by itself. No damage or hazards for the power supply will occur.

EMC Emission		According generic standards: EN 61000-6-3 and EN 61000-6-4	
Conducted emission input lines	EN 55011, EN 55022, FCC Part 15, CISPR 11, CISPR 22	Class B	
Conducted emission output lines**)	IEC/CISPR 16-1-2, IEC/CISPR 16-2-1	limits for DC power port according EN 61000-6-3 fulfilled	
Radiated emission	EN 55011, EN 55022	Class B	
Harmonic input current	EN 61000-3-2	fulfilled for class A equipment	
Voltage fluctuations, flicker	EN 61000-3-3	fulfilled*)	

This device complies with FCC Part 15 rules.

Operation is subjected to following two conditions: (1) this device may not cause harmful interference, and (2) this device must accept any interference received, including interference that may cause undesired operation.

- *) tested with constant current loads, non pulsing
- **) for information only, not mandatory for EN 61000-6-3

Switching Frequencies	The power supply has two converters with two different switching frequencies included.	
Switching frequency 1	70kHz to 140kHz	PFC converter, input voltage and output power dependent
Switching frequency 2	80kHz to 150kHz	Main converter, output power dependent

15. ENVIRONMENT

Operational temperature *)	-25°C to +70°C (-13°F to 158°F)	reduce output power according Fig. 15-1
Storage temperature	-40 to +85°C (-40°F to 185°F)	for storage and transportation
Output de-rating	6.4W/°C 12W/°C	45°C to 60°C (113°F to 140°F) 60°C to 70°C (140°F to 158°F)
Humidity **)	5 to 95% r.h.	IEC 60068-2-30
Vibration sinusoidal	2-17.8Hz: ±1.6mm; 17.8-500Hz: 2g***) 2 hours / axis	IEC 60068-2-6
Shock	30g 6ms, 20g 11ms***) 3 bumps / direction, 18 bumps in total	IEC 60068-2-27
Altitude	0 to 2000m (0 to 6 560ft) 2000 to 6000m (6 560 to 20 000ft)	without any restrictions reduce output power or ambient temperature, see Fig. 15-2 IEC 62103, EN 50178, overvoltage category II
Altitude de-rating	30W/1000m or 5°C/1000m	> 2000m (6500ft), see Fig. 15-2
Over-voltage category	III II	IEC 62103, EN 50178, altitudes up to 2000m altitudes from 2000m to 6000m
Degree of pollution	2	IEC 62103, EN 50178, not conductive
LABS compatibility	The unit does not release any silicone or other LABS-critical substances and is suitable for use in paint shops.	
Audible noise	At load currents below 2A some audible noise will be emitted from the power supply	

*) Operational temperature is the same as the ambient temperature and is defined as the air temperature 2cm below the unit.

**) Do not energize while condensation is present

***) Tested in combination with DIN-Rails according to EN 60715 with a height of 15mm and a thickness of 1.3mm and standard orientation. Higher levels allowed when using the wall mounting bracket ZM2.WALL

Fig. 15-1 Output current vs. ambient temp.

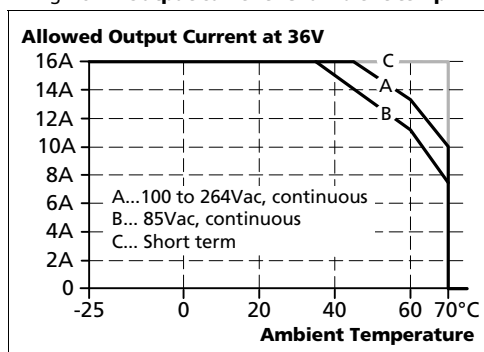
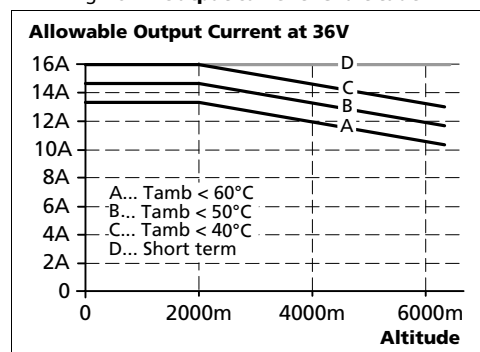

Fig. 15-2 Output current vs. altitude



See chapter 3 for de-rating requirements for input voltages between 85Vac and 100Vac.

16. PROTECTION FEATURES

Output protection	Electronically protected against overload, no-load and short-circuits ^{*)}	
Output over-voltage protection	typ. 48.5Vdc max. 50Vdc	In case of an internal power supply defect, a redundant circuit limits the maximum output voltage. The output shuts down and automatically attempts to restart.
Degree of protection	IP 20	EN/IEC 60529 Caution: For use in a controlled environment according to CSA 22.2 No 107.1-01.
Penetration protection	> 5mm	e.g. screws, small parts
Over-temperature protection	yes	Output shut-down with automatic restart
Input transient protection	MOV (Metal Oxide Varistor)	
Internal input fuse	included	not user replaceable

^{*)} In case of a protection event, audible noise may occur.

17. SAFETY FEATURES

Input / output separation ^{*)}	SELV PELV double or reinforced insulation	IEC/EN 60950-1 IEC/EN 60204-1, EN 50178, IEC 62103, IEC 60364-4-41
Class of protection	I	PE (Protective Earth) connection required
Isolation resistance	> 5MΩ	input to output, 500Vdc
PE resistance	< 0.1Ω	
Touch current (leakage current)	typ. 0.14mA / 0.37mA typ. 0.20mA / 0.55mA typ. 0.35mA / 0.87mA max. 0.17mA / 0.46mA max. 0.26mA / 0.67mA max. 0.46mA / 1.08mA	100Vac, 50Hz, TN-,TT-mains / IT-mains 120Vac, 60Hz, TN-,TT-mains / IT-mains 230Vac, 50Hz, TN-,TT-mains / IT-mains 110Vac, 50Hz, TN-,TT-mains / IT-mains 132Vac, 60Hz, TN-,TT-mains / IT-mains 264Vac, 50Hz, TN-,TT-mains / IT-mains

^{*)} double or reinforced insulation

18. DIELECTRIC STRENGTH

The output voltage is floating and has no ohmic connection to the ground. Type and factory tests are conducted by the manufacturer. Field tests may be conducted in the field using the appropriate test equipment which applies the voltage with a slow ramp (2s up and 2s down). Connect all input-terminals together as well as all output poles before conducting the test. When testing, set the cut-off current settings to the value in the table below.

Fig. 18-1 Dielectric strength

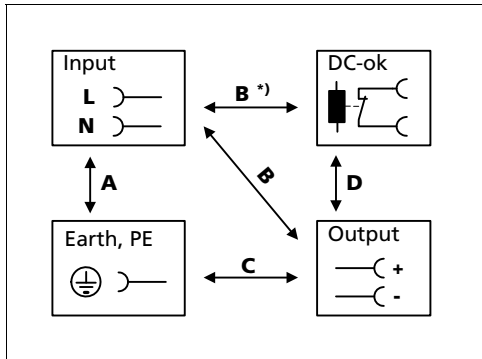









B*) When testing input to DC-OK ensure that the max. voltage between DC-OK and the output is not exceeded (column D). We recommend connecting DC-OK pins and the output pins together when performing the test.

		A	B	C	D
Type test	60s	2500Vac	3000Vac	1000Vac	500Vac
Factory test	5s	2500Vac	2500Vac	500Vac	500Vac
Field test	5s	2000Vac	2000Vac	500Vac	500Vac
Cut-off current setting		> 15mA	> 15mA	> 20mA	> 1mA

To fulfil the PELV requirements according to EN60204-1 § 6.4.1, we recommend that either the + pole, the – pole or any other part of the output circuit shall be connected to the protective earth system. This helps to avoid situations in which a load starts unexpectedly or can not be switched off when unnoticed earth faults occur.

19. APPROVALS

EC Declaration of Conformity		The CE mark indicates conformance with the - EMC directive 2004/108/EC, - Low-voltage directive (LVD) 2006/95/EC, - RoHS directive 2011/65/EU and the - ATEX directive 94/9/EC (for use in explosive atmospheres).
IEC 60950-1 2 nd Edition		CB Scheme, Information Technology Equipment
UL 508		Listed for use as Industrial Control Equipment; U.S.A. (UL 508) and Canada (C22.2 No. 107-1-01); E-File: E198865
UL 60950-1 2 nd Edition		Recognized for use as Information Technology Equipment, Level 5; U.S.A. (UL 60950-1) and Canada (C22.2 No. 60950-1); E-File: E137006 Applicable for altitudes up to 2000m.
ANSI / ISA 12.12.01-2007 Class I Div 2		Recognized for use in Hazardous Location Class I Div 2 T3 Groups A,B,C,D systems; U.S.A. (ANSI / ISA 12.12.01-2007) and Canada (C22.2 No. 213-M1987)
EN 60079-0, EN 60079-15 ATEX	 II 3G Ex nA nC II T3 Gc	Approval for use in hazardous locations Zone 2 Category 3G. Number of ATEX certificate: EPS 13 ATEX 1 555 X The power supply must be built-in in an IP54 enclosure.
IEC 60079-0, IEC 60079-15		Suitable for use in Class 1 Zone 2 Groups IIa, IIb and IIc locations. Number of IECEX certificate: IECEX EPS 13.0016X
Marine		GL (Germanischer Lloyd) classified Environmental category: C, EMC2 Marine and offshore applications
GOST R		Certificate of Conformity for Russia and other GUS countries

20. PHYSICAL DIMENSIONS AND WEIGHT

Weight	1000g / 2.2lb
DIN-Rail	Use 35mm DIN-rails according to EN 60715 or EN 50022 with a height of 7.5 or 15mm. The DIN-rail height must be added to the unit depth (127mm) to calculate the total required installation depth.
Installation Clearances	See chapter 2

Fig. 20-1 **Front view**

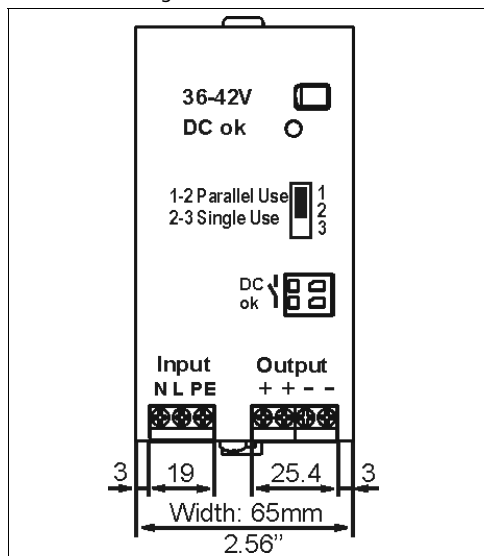
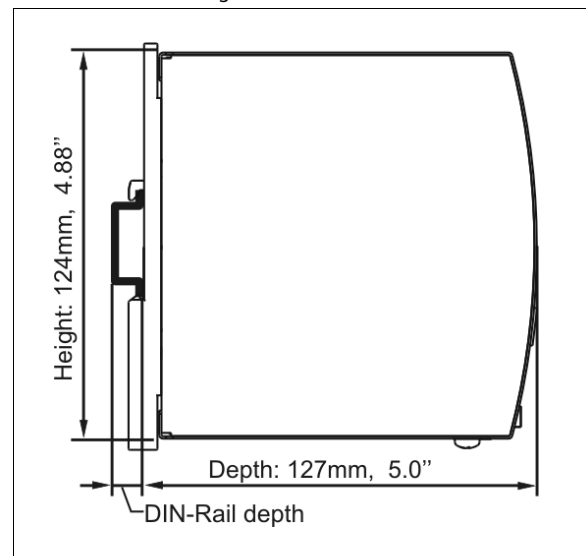

Fig. 20-2 **Side view**



21. ACCESSORIES

21.1. ZM2.WALL - WALL MOUNTING BRACKET

This bracket is used to mount the power supply onto a flat surface without utilizing a DIN-Rail.

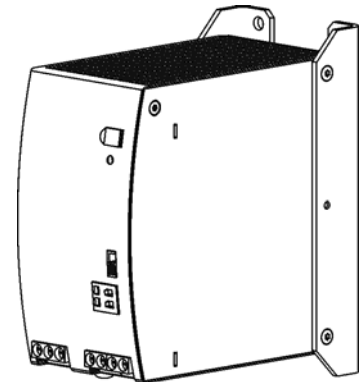
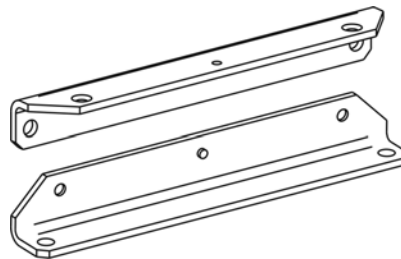

21.2. ZM13.SIDE - SIDE MOUNTING BRACKET

This bracket is used to mount DIMENSION units sideways with or without utilizing a DIN-Rail. The two aluminum brackets and the black plastic slider of the unit have to be detached, so that the steel brackets can be mounted.

For sideways DIN-rail mounting, the removed aluminum brackets and the black plastic slider need to be mounted on the steel bracket.

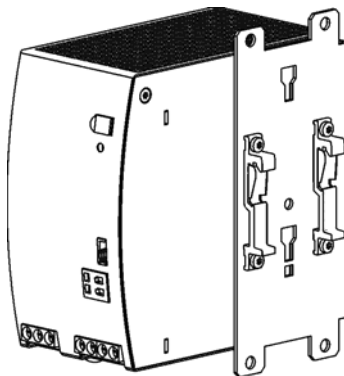

Side mounting with DIN-rail brackets

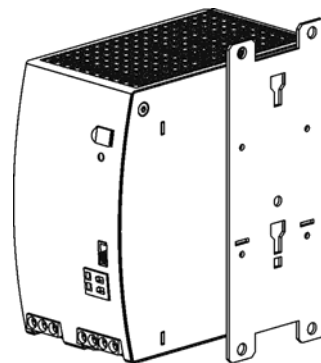

Side mounting without DIN-rail brackets

21.3. REDUNDANCY MODULES

YR40.482 – (2x 20A Inputs, 1x 40A output)



The YR40.482 is equipped with two input channels, which are individually decoupled by utilizing mosfet technology. Using mosfets instead of diodes reduces the heat generation and the voltage drop between input and output. The YR40.482 does not require an additional auxiliary voltage and is self-powered even in case of a short circuit across the output.

Due to the low power losses, the unit is very slender and only requires 46mm width on the DIN-rail.

Fig. 21-1 **Typical 1+1 Redundant configuration for 36V, 13.3A with a dual redundancy module**

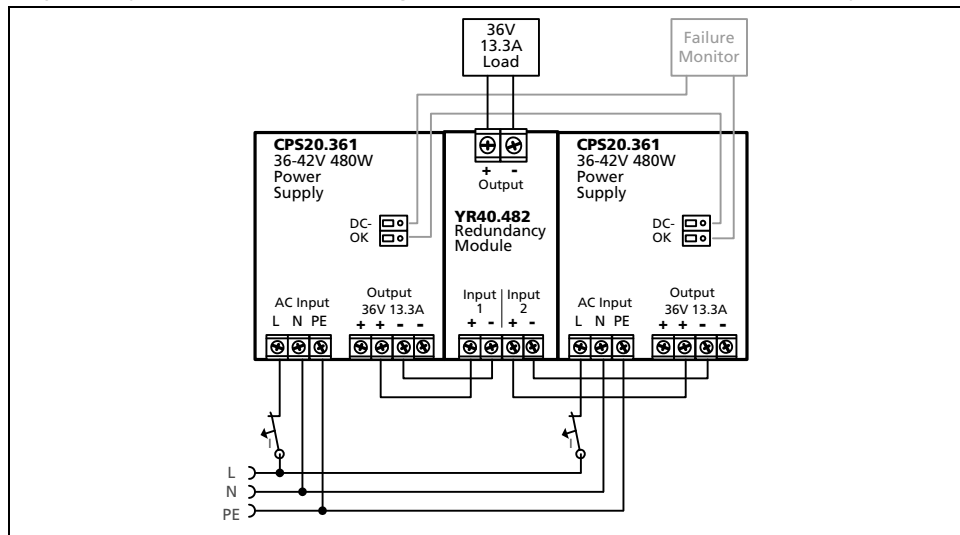

22. APPLICATION NOTES

22.1. PEAK CURRENT CAPABILITY

The power supply can deliver peak currents (up to several milliseconds) which are higher than the specified short term currents.

This helps to start current demanding loads. Solenoids, contactors and pneumatic modules often have a steady state coil and a pick-up coil. The inrush current demand of the pick-up coil is several times higher than the steady-state current and usually exceeds the nominal output current (including the PowerBoost). The same situation applies when starting a capacitive load.

The peak current capability also ensures the safe operation of subsequent circuit breakers of load circuits. The load branches are often individually protected with circuit breakers or fuses. In case of a short or an overload in one branch circuit, the fuse or circuit breaker need a certain amount of over-current to open in a timely manner. This avoids voltage loss in adjacent circuits.

The extra current (peak current) is supplied by the power converter and the built-in large sized output capacitors of the power supply. The capacitors get discharged during such an event, which causes a voltage dip on the output. The following two examples show typical voltage dips:

Fig. 22-1 **Peak load with 2x the nominal current for 50ms, typ.**

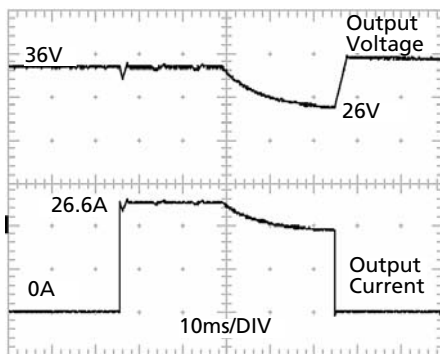

26.6A Peak load (resistive) for 50ms
Output voltage dips from 36V to 26V.

Fig. 22-2 **Peak load with 5x the nominal current for 5ms, typ.**

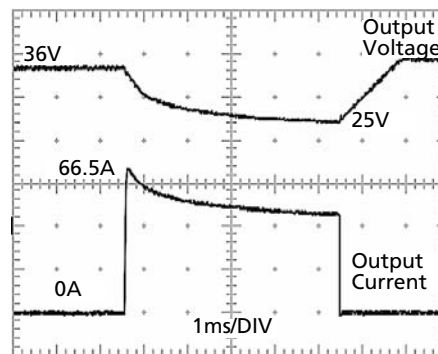

66.5A Peak load (resistive) for 5ms
Output voltage dips from 36V to 25V.

Peak current voltage dips	typ.	from 36V to 26V	at 26.6A for 50ms, resistive load
	typ.	from 36V to 26V	at 66.5A for 2ms, resistive load
	typ.	from 36V to 25V	at 66.5A for 5ms, resistive load

22.2. BACK-FEEDING LOADS

Loads such as decelerating motors and inductors can feed voltage back to the power supply. This feature is also called return voltage immunity or resistance against Back- E.M.F. (Electro Magnetic Force).

This power supply is resistant and does not show malfunctioning when a load feeds back voltage to the power supply. It does not matter whether the power supply is on or off.

The maximum allowed feed-back-voltage is 50Vdc. The absorbing energy can be calculated according to the built-in large sized output capacitor which is specified in chapter 6.

22.3. EXTERNAL INPUT PROTECTION

The unit is tested and approved for branch circuits up to 30A (UL) and 32A (IEC). An external protection is only required if the supplying branch has an ampacity greater than this. Check also local codes and local requirements. In some countries local regulations might apply.

If an external fuse is necessary or utilized, minimum requirements need to be considered to avoid nuisance tripping of the circuit breaker. A minimum value of 10A B- or C-Characteristic breaker should be used.

22.4. OUTPUT CIRCUIT BREAKERS

Standard miniature circuit breakers (MCB's or UL 1077 circuit breakers) are commonly used for AC-supply systems and may also be used on 36V branches.

MCB's are designed to protect wires and circuits. If the ampere value and the characteristics of the MCB are adapted to the wire size that is used, the wiring is considered as thermally safe regardless of whether the MCB opens or not.

To avoid voltage dips and under-voltage situations in adjacent 36V branches which are supplied by the same source, a fast (magnetic) tripping of the MCB is desired. A quick shutdown within 10ms is necessary corresponding roughly to the ride-through time of PLC's. This requires power supplies with high current reserves and large output capacitors. Furthermore, the impedance of the faulty branch must be sufficiently small in order for the current to actually flow. The best current reserve in the power supply does not help if Ohm's law does not permit current flow. The following table has typical test results showing which B- and C-Characteristic MCBs magnetically trip depending on the wire cross section and wire length.

Fig. 22-3 Test circuit

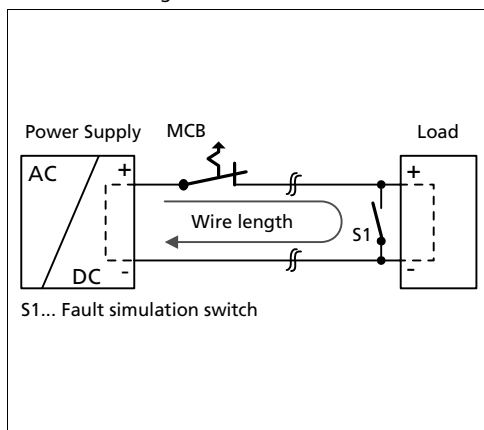

Maximal wire length^{*)} for a fast (magnetic) tripping:

	0.75mm ²	1.0mm ²	1.5mm ²	2.5mm ²
C-2A	51m	69m	100m	153m
C-3A	43m	57m	83m	128m
C-4A	32m	44m	64m	99m
C-6A	8m	13m	19m	31m
C-8A	3m	5m	7m	10m
C-10A	2m	4m	6m	8m
C-13A	-	1m	2m	5m
B-6A	29m	39m	54m	79m
B-10A	8m	11m	19m	24m
B-13A	7m	9m	14m	23m
B-16A	1m	1m	2m	4m

*) Don't forget to consider twice the distance to the load (or cable length) when calculating the total wire length (+ and - wire).

22.5. PARALLEL USE TO INCREASE OUTPUT POWER

CPS20.361 power supplies can be paralleled to increase the output power. The output voltage of all power supplies shall be adjusted to the same value ($\pm 100\text{mV}$) in "Single use" mode with the same load conditions on all units, or the units can be left with the factory settings. After the adjustments, the jumper on the front of the unit shall be moved from "Single use" to "Parallel use", in order to achieve load sharing. The "Parallel use" mode regulates the output voltage in such a manner that the voltage at no load is approx. 4% higher than at nominal load. See also chapter 6. If no jumper is plugged in, the unit is in "Single use" mode. Factory setting is "Single use" mode.

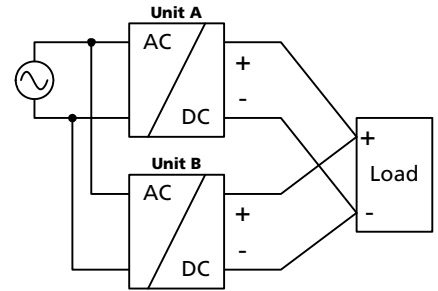

If more than three units are connected in parallel, a fuse or circuit breaker with a rating of 20A is required on each output. Alternatively, a diode or redundancy module can also be utilized.

Energize all units at the same time to avoid the overload Hiccup^{PLUS} mode. It also might be necessary to cycle the input power (turn-off for at least five seconds), if the output was in Hiccup^{PLUS} mode due to overload or short circuits and the required output current is higher than the current of one unit.

Keep an installation clearance of 15mm (left / right) between two power supplies and avoid installing the power supplies on top of each other. Do not use power supplies in parallel in mounting orientations other than the standard mounting orientation (terminals on bottom of the unit) or in any other condition where a derating of the output current is required (e.g. altitude, above 60°C, ...).

Pay attention that leakage current, EMI, inrush current, harmonics will increase when using multiple power supplies.

22.6. PARALLEL USE FOR REDUNDANCY

Power supplies can be paralleled for redundancy to gain higher system availability. Redundant systems require a certain amount of extra power to support the load in case one power supply unit fails. The simplest way is to put two power supplies in parallel. This is called a 1+1 redundancy. In case one power supply unit fails, the other one is automatically able to support the load current without any interruption. Redundant systems for a higher power demand are usually built in a N+1 method. E.g. five power supplies, each rated for 13.3A are paralleled to build a 53A redundant system. For N+1 redundancy the same restrictions apply as for increasing the output power, see also section 22.5.

Please note: This simple way to build a redundant system does not cover failures such as an internal short circuit in the secondary side of the power supply. In such a case, the defective unit becomes a load for the other power supplies and the output voltage can not be maintained any more. This can be avoided by utilizing redundancy modules, which have decoupling devices (diodes or mosfets) included. Further information and wiring configurations can be found in chapter 21.3.

Recommendations for building redundant power systems:

- a) Use separate input fuses for each power supply.
- b) Set the power supply into "Parallel use" mode.
- c) Monitor the individual power supply units. Therefore, use the DC-OK relay contact of the CPS20 power supply.
- d) It is desirable to set the output voltages of all units to the same value ($\pm 100\text{mV}$) or leave it at the factory setting.

22.7. SERIES OPERATION

Power supplies of the same type can be connected in series for higher output voltages. It is possible to connect as many units in series as needed, providing the sum of the output voltage does not exceed 150Vdc. Voltages with a potential above 60Vdc are not SELV any more and can be dangerous. Such voltages must be installed with a protection against touching.

Earthing of the output is required when the sum of the output voltage is above 60Vdc.

Avoid return voltage (e.g. from a decelerating motor or battery) which is applied to the output terminals.

Keep an installation clearance of 15mm (left / right) between two power supplies and avoid installing the power supplies on top of each other. Do not use power supplies in series in mounting orientations other than the standard mounting orientation (terminals on bottom of the unit).

Pay attention that leakage current, EMI, inrush current, harmonics will increase when using multiple power supplies.

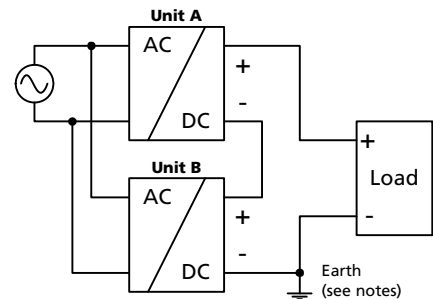

22.8. INDUCTIVE AND CAPACITIVE LOADS

The unit is designed to supply any kind of loads, including capacitive and inductive loads. If extreme large capacitors, such as EDLCs (electric double layer capacitors or "UltraCaps") with a capacitance > 0.15F are connected to the output, the unit might charge the capacitor in the Hiccup^{PLUS} mode (see chapter 6).

22.9. CHARGING OF BATTERIES

The power supply can be used to charge lead-acid or maintenance free batteries. (Three 12V batteries in series)

Instructions for charging batteries:

- Set output voltage (measured at no load and at the battery end of the cable) very precisely to the end-of-charge voltage.

End-of-charge voltage	41.7V	41.25V	40.8V	40.35V
Battery temperature	10°C	20°C	30°C	40°C

- Use a 20A or 25A circuit breaker (or blocking diode) between the power supply and the battery.
- Ensure that the output current of the power supply is below the allowed charging current of the battery.
- Use only matched batteries when putting 12V types in series.
- The return current to the power supply (battery discharge current) is typ. 22mA when the power supply is switched off (except in case a blocking diode is utilized).

22.10. OPERATION ON TWO PHASES

The power supply can also be used on two-phases of a three-phase-system. Such a phase-to-phase connection is allowed as long as the supplying voltage is below $240V^{+10\%}$.

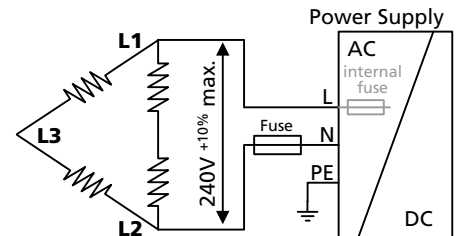

22.11. USE IN A TIGHTLY SEALED ENCLOSURE

When the power supply is installed in a tightly sealed enclosure, the temperature inside the enclosure will be higher than outside. In such situations, the inside temperature defines the ambient temperature for the power supply.

The following measurement results can be used as a reference to estimate the temperature rise inside the enclosure.

The power supply is placed in the middle of the box, no other heat producing items are inside the box

Enclosure:	Rittal Typ IP66 Box PK 9522 100, plastic, 254x180x165mm
Load:	36V, 10.6A; (=80%) load is placed outside the box
Input:	230Vac
Temperature inside enclosure:	52.6°C (in the middle of the right side of the power supply with a distance of 2cm)
Temperature outside enclosure:	24.0°C
Temperature rise:	28.6K

22.12. MOUNTING ORIENTATIONS

Mounting orientations other than all terminals on the bottom require a reduction in continuous output power or a limitation in the maximum allowed ambient temperature. The amount of reduction influences the lifetime expectancy of the power supply. Therefore, two different derating curves for continuous operation can be found below:

Curve A1 Recommended output current.

Curve A2 Max allowed output current (results in approximately half the lifetime expectancy of A1).

Fig. 22-4
Mounting Orientation A
(Standard orientation)

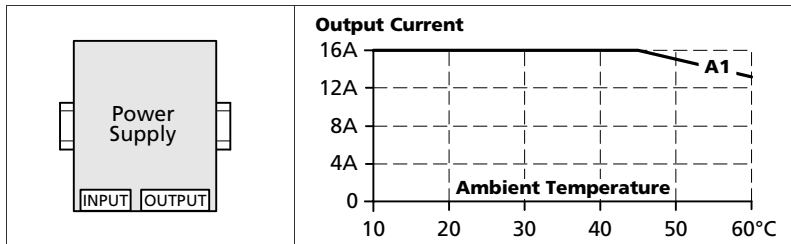

Fig. 22-5
Mounting Orientation B
(Upside down)

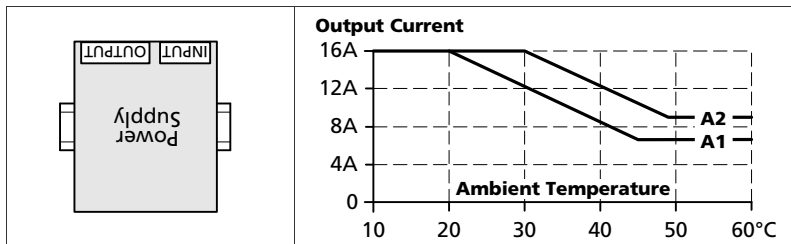

Fig. 22-6
Mounting Orientation C
(Table-top mounting)

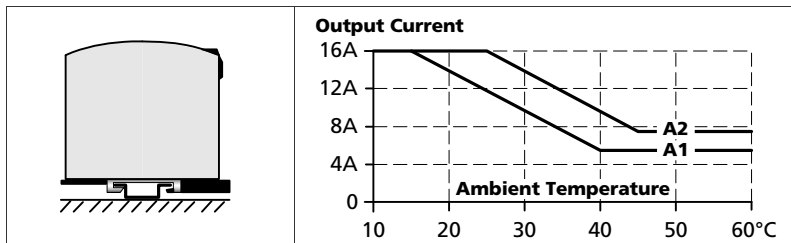

Fig. 22-7
Mounting Orientation D
(Horizontal cw)

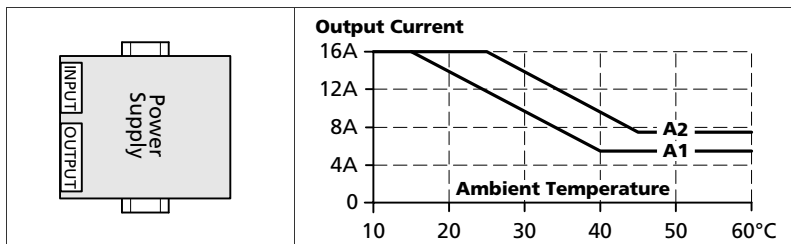

Fig. 22-8
Mounting Orientation E
(Horizontal ccw)

