

Single-Output LDO Regulator

1A Fixed Output LDO Regulators



BD80C0AFPS-M BD90C0AFPS-M

● **General Description**

The BD80C0AFPS-M and BD90C0AFPS-M are low-saturation regulators. These ICs have built in over current protection to protect the device when output is shorted and thermal shutdown circuit to protect the device during over load conditions.

● **Features**

- Output Current capability : 1A
- High Output Voltage Precision: ±1%
- Low saturation with PDMOS output
- Built-in over-current protection circuit that prevents the destruction of the IC due to output short circuits
- Built-in thermal shutdown circuit for protecting the IC from thermal damage due to overloading
- Low ESR Capacitor
- AEC-Q100 Qualified

● **Applications**

Audiovisual equipments, FPDs, televisions, personal computers or any other consumer device

● **Key Specification**

- Supply Voltage range: $V_{o+1.0V}$ to 26.5V
- Output voltage
BD80C0AFPS-M: 8.0V
BD90C0AFPS-M: 9.0V
- Output current: 1A
- Operating temperature range: $-40^{\circ}C \leq T_a \leq +105^{\circ}C$

● **Package**

TO252S-3 W (Typ.) x D (Typ.) x H (Max.)
6.50mm x 9.50mm x 1.30mm

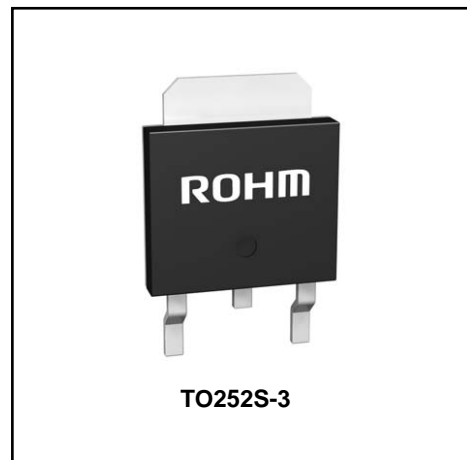

● **Typical Application Circuit**

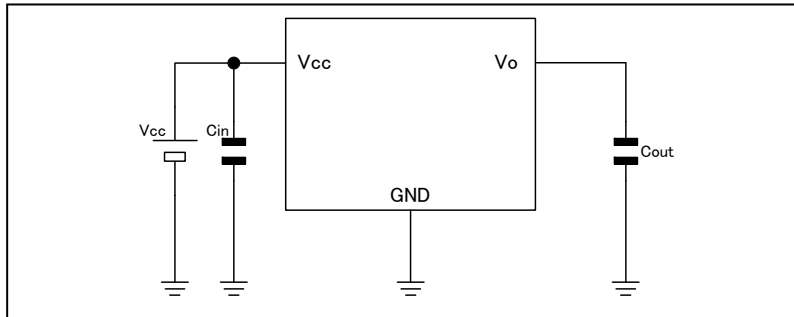
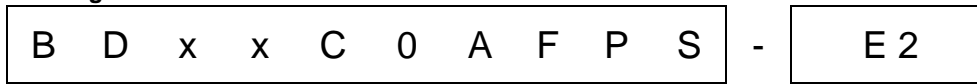

Figure 1. Typical Application Circuit

● **Ordering Information**



| | | | | |
|-------------|--|----------------------------|-------------------------|---|
| Part Number | Output Voltage 80:8.0V Output 90:9.0V Output | Current capacity C0A:1A | Package FPS:TO252S-3 | Packaging and forming specification E2: Embossed tape and reel |
|-------------|--|----------------------------|-------------------------|---|

● **Lineup**

| Maximum Output Current (Max.) | Output Voltage (Typ.) | Package | | Orderable Part Number |
|-------------------------------|-----------------------|----------|--------------|-----------------------|
| 1A | 8.0V | TO252S-3 | Reel of 2000 | BD80C0AFPS-M -E2 |
| | 9.0V | | | BD90C0AFPS-M -E2 |

○Product structure : Silicon monolithic integrated circuit ○This product is not designed protection against radioactive rays.

●Pin Configuration

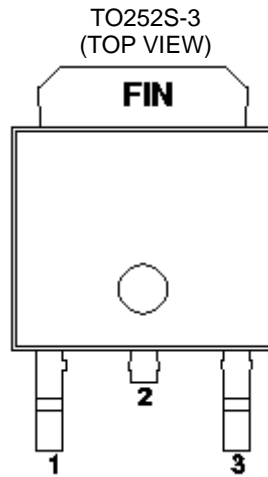

Figure 2. Pin Configuration

●Pin Description

| Pin No. | Symbol | Function |
|---------|--------|------------------|
| 1 | Vcc | Power Supply Pin |
| 2 | N.C. | N.C. Pin |
| 3 | Vo | Output Pin |
| FIN | GND | GND |

※N.C.Pin can be open. Because it isn't connect it inside of IC.

●Block Diagram

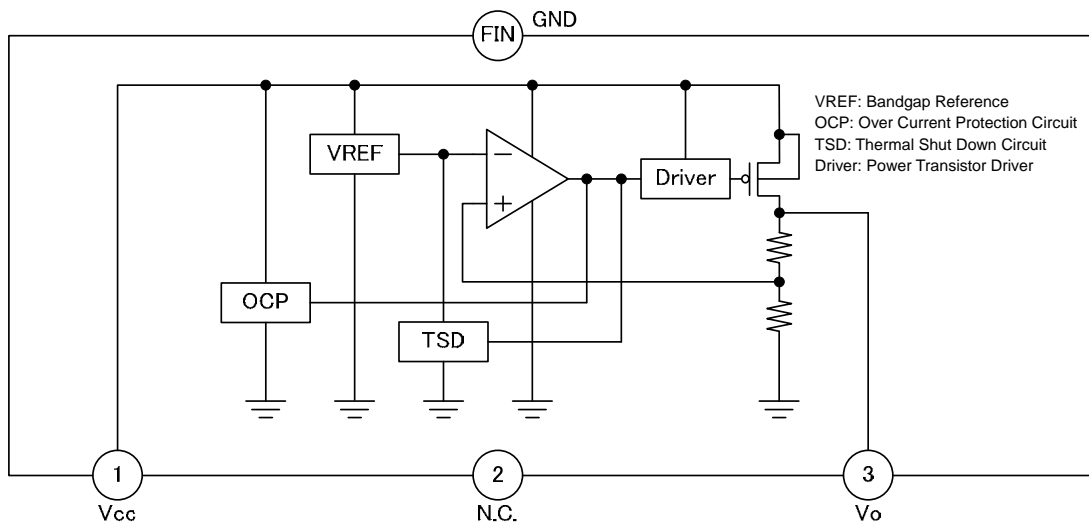

Figure 3. Block Diagram

● Absolute Maximum Ratings (Ta=25°C)

| Parameter | Symbol | Ratings | Unit |
|------------------------------|-------------------------------|---------------|------|
| Supply Voltage | V _{CC} ^{*1} | -0.3 to +35.0 | V |
| Power Dissipation | P _d ^{*2} | 1.2 | W |
| Operating Temperature Range | T _{opr} | -40 to +105 | °C |
| Storage Temperature Range | T _{stg} | -55 to +150 | °C |
| Maximum Junction Temperature | T _{jmax} | +150 | °C |

*1 Not to exceed P_d.

*2 TO252S-3: Reduced by 9.6mW / °C over Ta = 25°C, when mounted on glass epoxy board: 70mm × 70mm × 1.6mm.

● Recommended Operating Ratings (Ta=25°C)

■ BD80C0AFPS-M

| Parameter | Symbol | Min. | Max. | Unit |
|----------------|-----------------|------|------|------|
| Supply Voltage | V _{CC} | 9.0 | 26.5 | V |
| Output Current | I _o | 0 | 1.0 | A |

■ BD90C0AFPS-M

| Parameter | Symbol | Min. | Max. | Unit |
|----------------|-----------------|------|------|------|
| Supply Voltage | V _{CC} | 10.0 | 26.5 | V |
| Output Current | I _o | 0 | 1.0 | A |

● Electrical Characteristics

■ BD80C0AFPS-M (Unless otherwise specified, Ta=25°C, V_{CC}=13V, I_o=0mA)

| Parameter | Symbol | Guaranteed Limits | | | Unit | Conditions |
|---|--------------------|-------------------|-----------------------|-----------------------|------|--|
| | | Min. | Typ. | Max. | | |
| Circuit Current | I _b | — | 0.6 | 1.0 | mA | |
| Output Voltage | V _o | 7.92 | 8.00 | 8.08 | V | I _o =500mA |
| Dropout Voltage | ΔV _d | — | 0.3 | 0.5 | V | V _{CC} =V _o × 0.95, I _o =500mA |
| Ripple Rejection | R.R. | 40 | 50 | — | dB | f=120Hz, e _{in} ^{*1} =1Vrms, I _o =100mA |
| Line Regulation | Reg.I | — | 20 | 60 | mV | V _{CC} =9→25V |
| Load Regulation | Reg.L | — | V _o ×0.010 | V _o ×0.015 | V | I _o =5mA→1A |
| Temperature Coefficient of Output Voltage | T _{cv0.1} | — | +0.04 | — | %/°C | I _o =5mA, T _j =-40°C to -20°C |
| | T _{cv0.2} | — | ±0.005 | — | %/°C | I _o =5mA, T _j =-20°C to +105°C |

*1 e_{in}: Input Voltage Ripple

■ BD90C0AFPS-M (Unless otherwise specified, Ta=25°C, V_{CC}=14V, I_o=0mA)

| Parameter | Symbol | Guaranteed Limits | | | Unit | Conditions |
|---|--------------------|-------------------|-----------------------|-----------------------|------|--|
| | | Min. | Typ. | Max. | | |
| Circuit Current | I _b | — | 0.6 | 1.0 | mA | |
| Output Voltage | V _o | 8.91 | 9.00 | 9.09 | V | I _o =500mA |
| Dropout Voltage | ΔV _d | — | 0.3 | 0.5 | V | V _{CC} =V _o × 0.95, I _o =500mA |
| Ripple Rejection | R.R. | 40 | 50 | — | dB | f=120Hz, e _{in} ^{*1} =1Vrms, I _o =100mA |
| Line Regulation | Reg.I | — | 20 | 60 | mV | V _{CC} =10→25V |
| Load Regulation | Reg.L | — | V _o ×0.010 | V _o ×0.015 | V | I _o =5mA→1A |
| Temperature Coefficient of Output Voltage | T _{cv0.1} | — | +0.04 | — | %/°C | I _o =5mA, T _j =-40°C to -20°C |
| | T _{cv0.2} | — | ±0.005 | — | %/°C | I _o =5mA, T _j =-20°C to +105°C |

*1 e_{in}: Input Voltage Ripple

● Typical Performance Curves

BD80C0AFPS-M (Unless otherwise specified, $T_a=25^\circ\text{C}$, $V_{cc}=13\text{V}$, $I_o=0\text{mA}$)

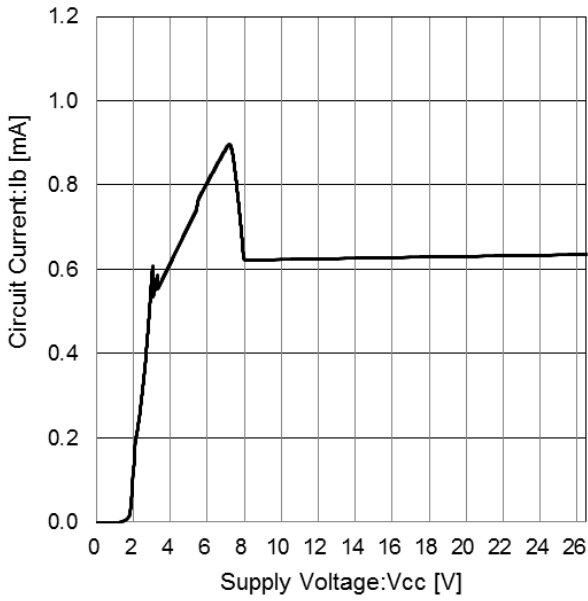

Figure 4. Circuit Current

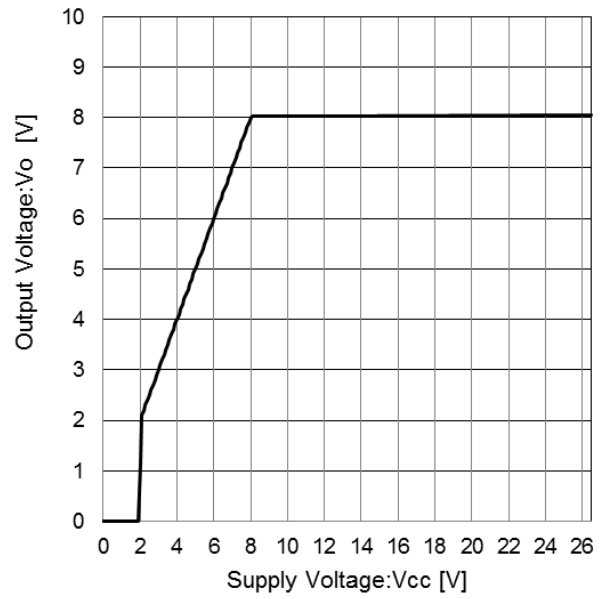

Figure 5. Line Regulation ($I_o=0\text{mA}$)

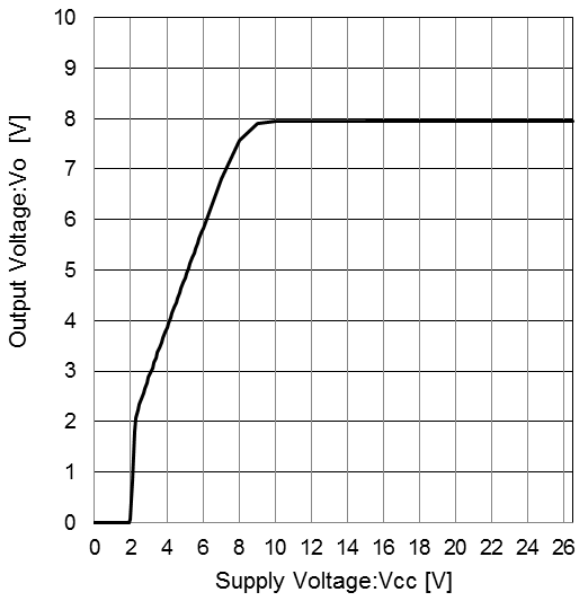

Figure 6. Line Regulation ($I_o=500\text{mA}$)

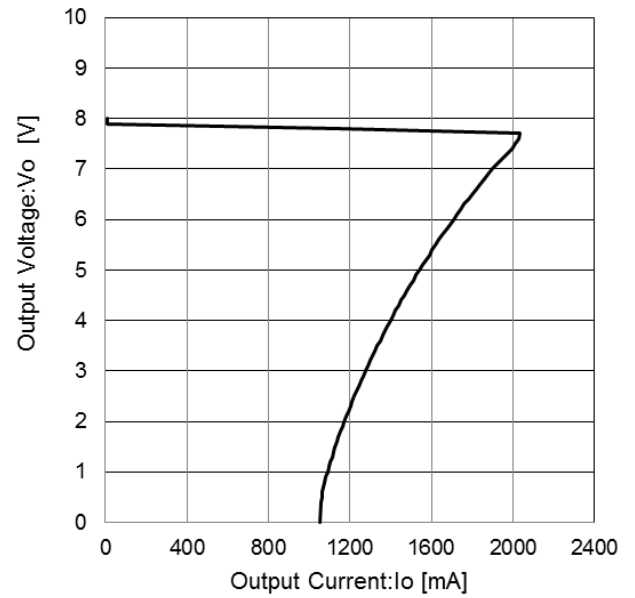

Figure 7. Load Regulation

● Typical Performance Curves - Continued

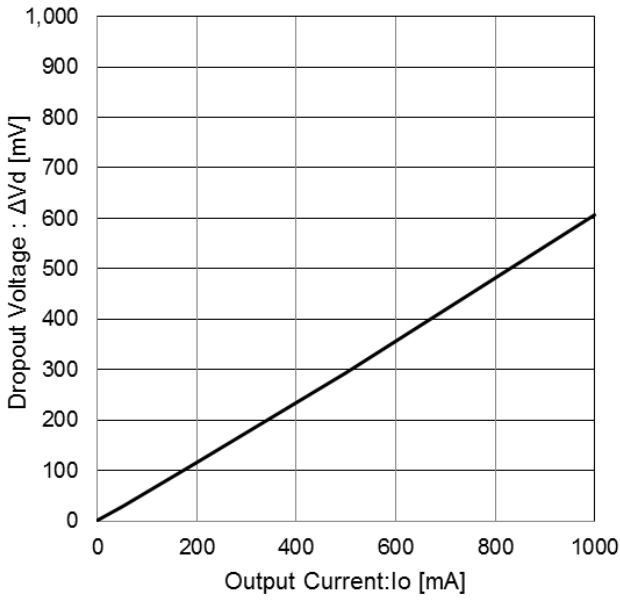

Figure 8. Dropout Voltage
 ($V_{cc}=V_o \times 0.95V$)
 ($I_o=0mA \rightarrow 1000mA$)

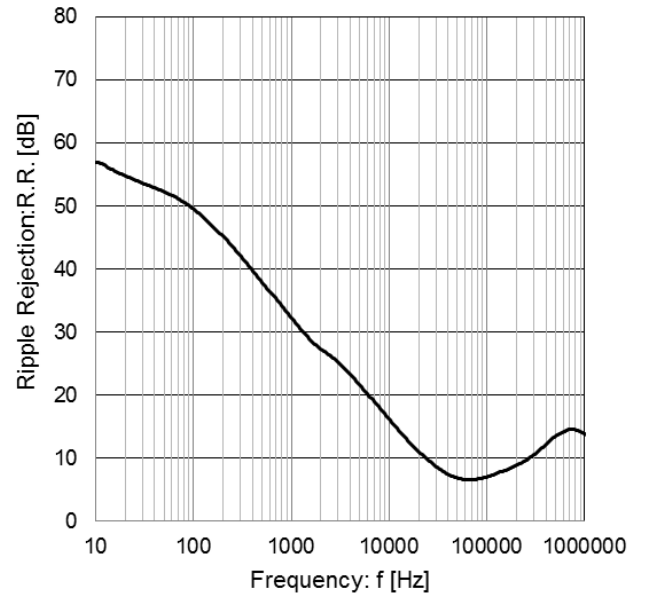

Figure 9. Ripple Rejection
 ($I_o = 100mA$)

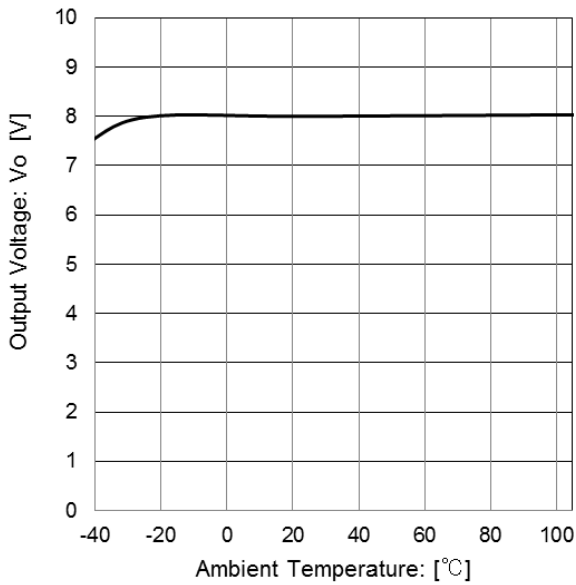

Figure 10. Output Voltage
 Temperature Characteristic

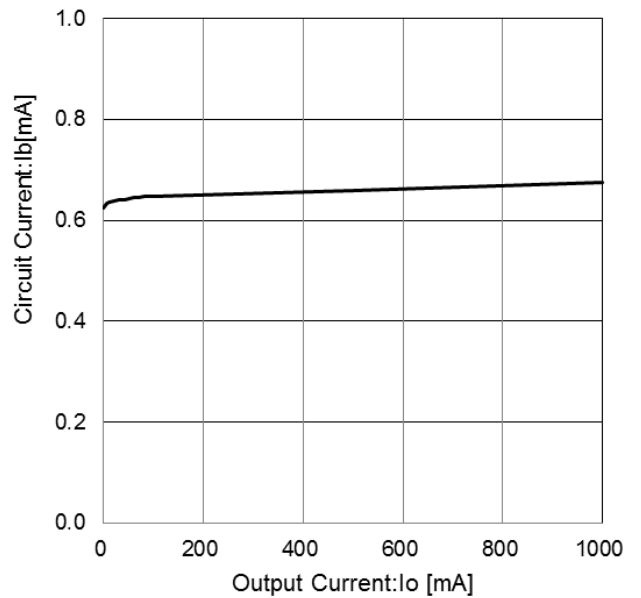

Figure 11. Circuit Current
 ($I_o=0mA \rightarrow 1000 mA$)

● Typical Performance Curves - Continued

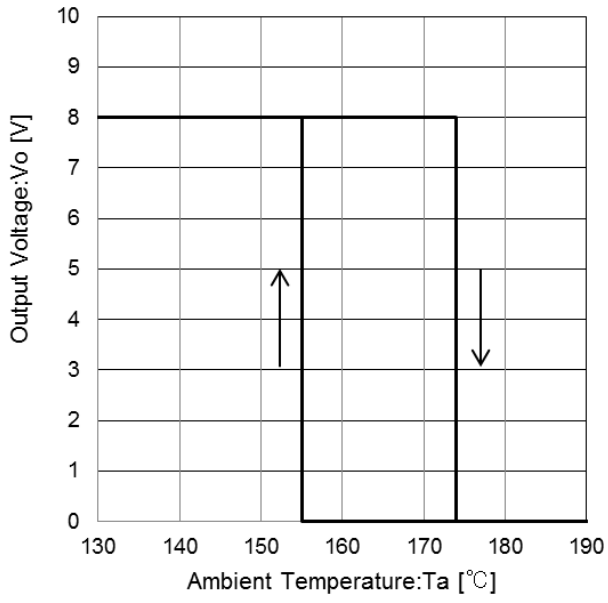

Figure 12. Thermal Shutdown Circuit Characteristic

● Typical Performance Curves - Continued

BD90C0AFPS-M (Unless otherwise specified, $T_a=25^\circ\text{C}$, $V_{cc}=14\text{V}$, $I_o=0\text{mA}$)

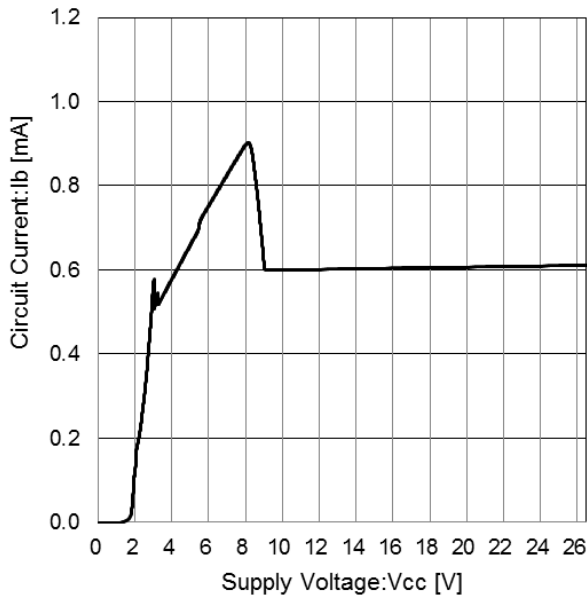

Figure 13. Circuit Current

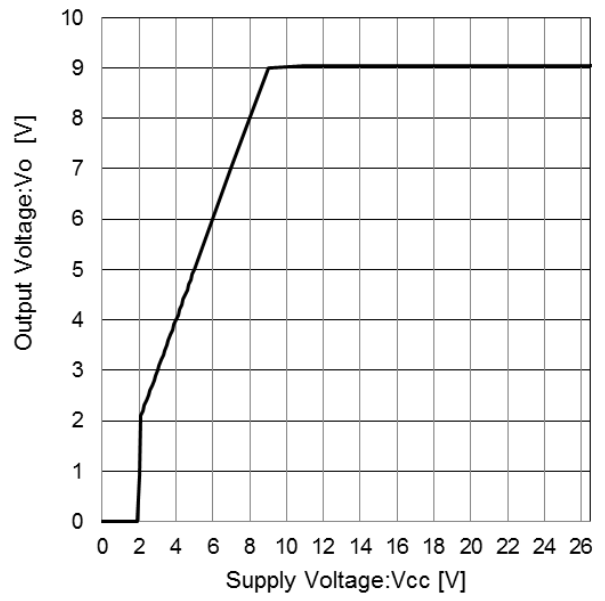

Figure 14. Line Regulation ($I_o=0\text{mA}$)

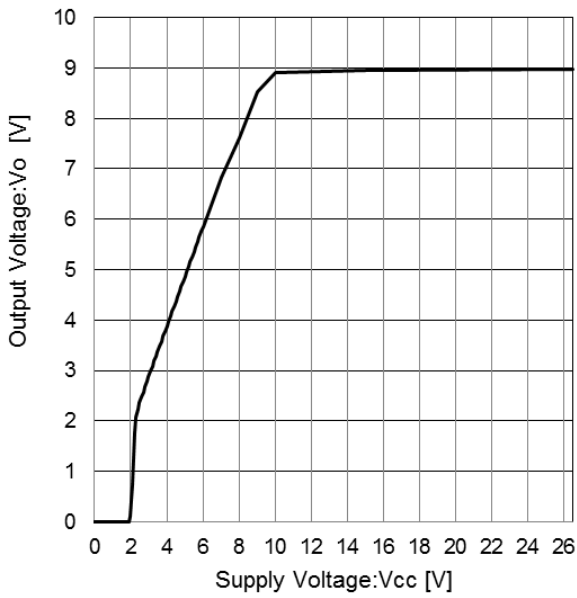

Figure 15. Line Regulation ($I_o=500\text{mA}$)

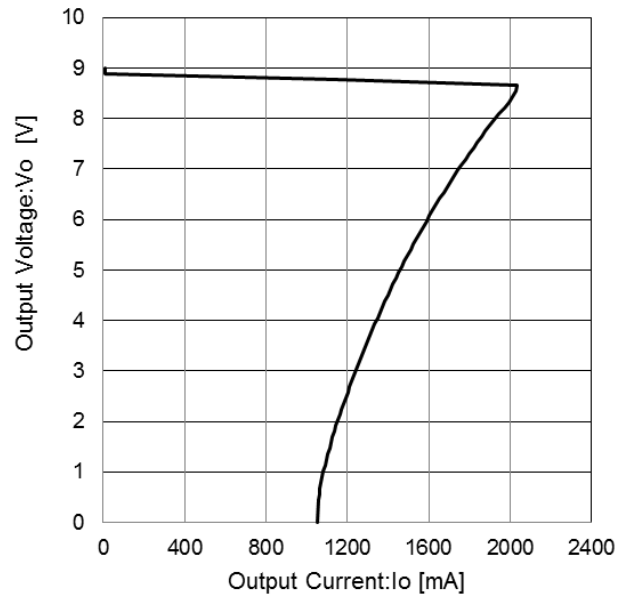

Figure 16. Load Regulation

● Typical Performance Curves - Continued

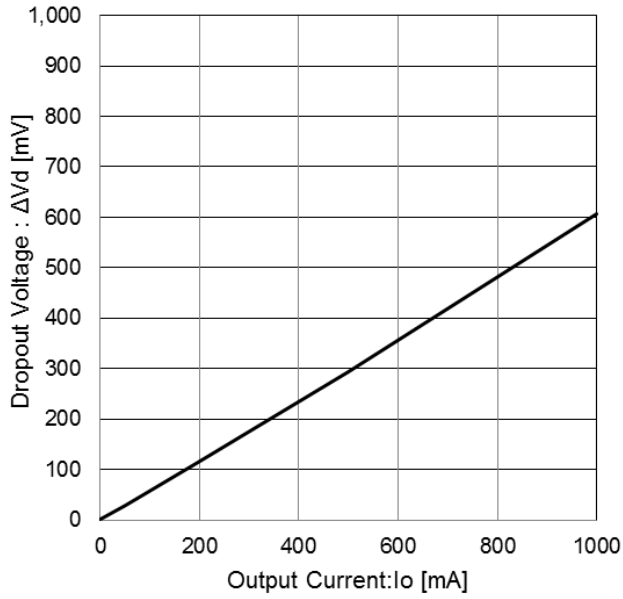

Figure 17. Dropout Voltage
($V_{CC}=V_o \times 0.95V$)
($I_o=0mA \rightarrow 1000mA$)

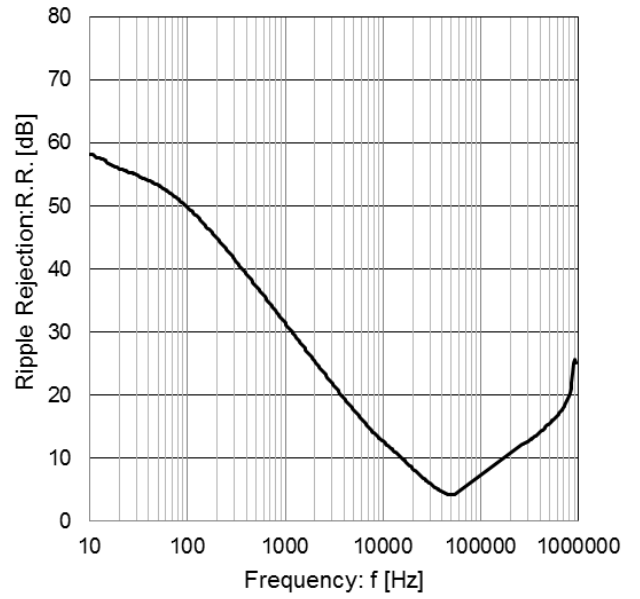

Figure 18. Ripple Rejection
($I_o=100mA$)

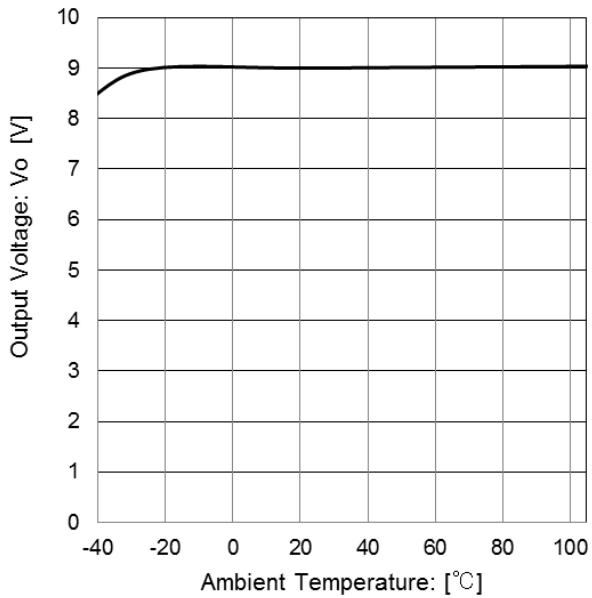

Figure 19. Output Voltage
Temperature Characteristic

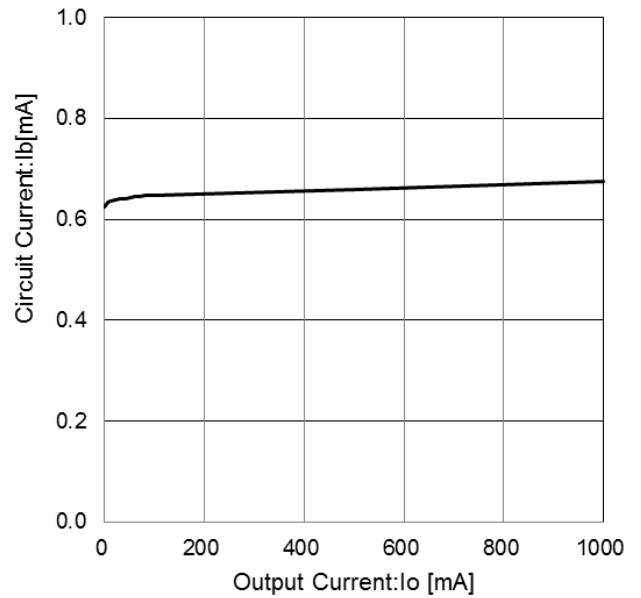

Figure 20. Circuit Current
($I_o=0mA \rightarrow 1000 mA$)

● Typical Performance Curves - Continued

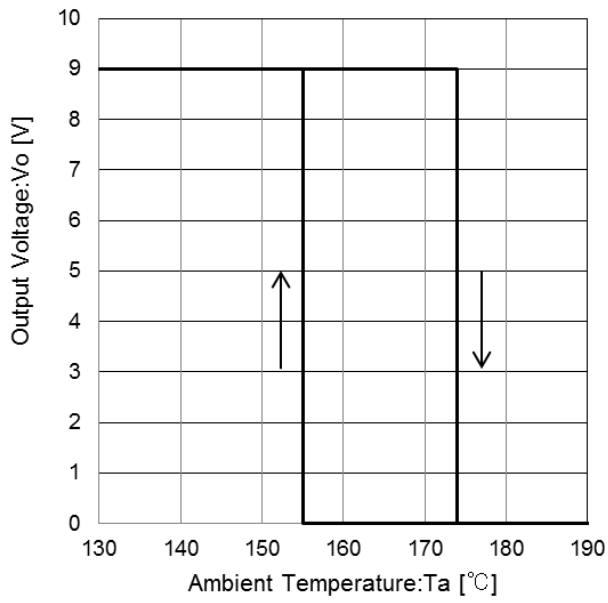
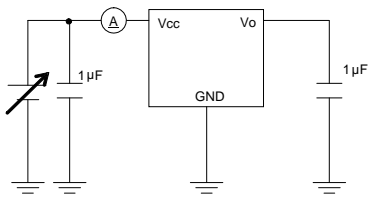
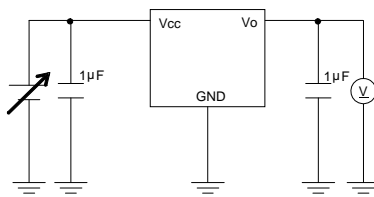

Figure 21. Thermal Shutdown Circuit Characteristic

● Measurement Circuit for Typical Performance Curves (BD80C0AFPS-M and BD90C0AFPS-M)



Measurement Circuit of Figure 4 and Figure 13



Measurement Circuit of Figure 5 and Figure 14

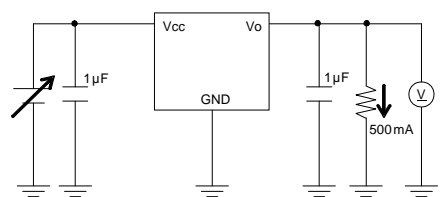

Measurement Circuit of Figure 6 and Figure 15

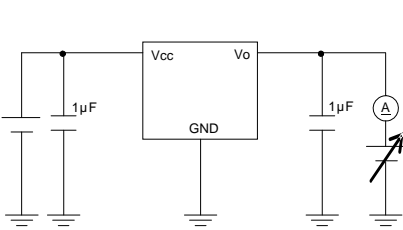

Measurement Circuit of Figure 7 and Figure 16

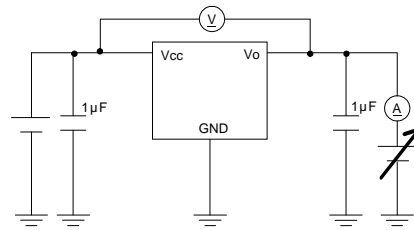

Measurement Circuit of Figure 8 and Figure 17

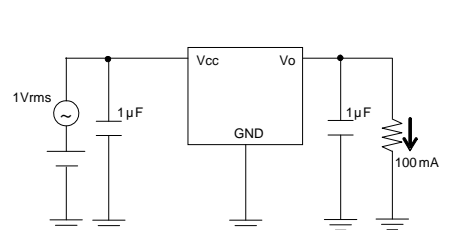

Measurement Circuit of Figure 9 and Figure 18

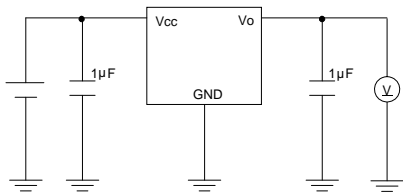

Measurement Circuit of Figure 10 and Figure 19

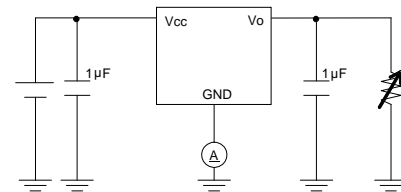

Measurement Circuit of Figure 11 and Figure 20

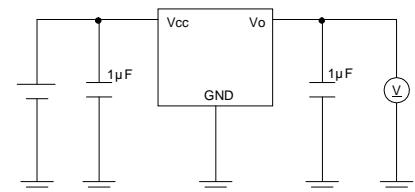

Measurement Circuit of Figure 12 and Figure 21

● Application Examples

- Positive voltage surges on V_{CC} pin

A power zener diode should be inserted between V_{CC} and GND for protection against voltage surges of more than 35V on the V_{CC} pin.

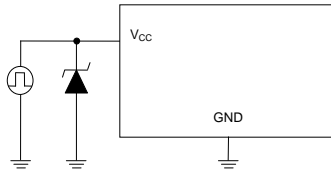

Figure 22.

- Negative voltage surges on V_{CC} pin

A schottky barrier diode should be inserted between V_{CC} and GND for protection against voltages lower than GND on the V_{CC} pin.

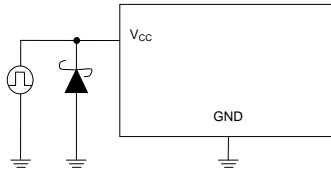

Figure 23.

- Output protection diode

Loads with large inductance components may cause reverse current flow during startup or shutdown. In such cases, a protection diode should be inserted on the output to protect the IC.

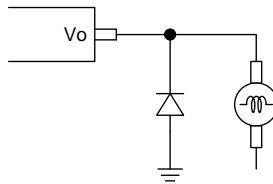

Figure 24.

●Power Dissipation

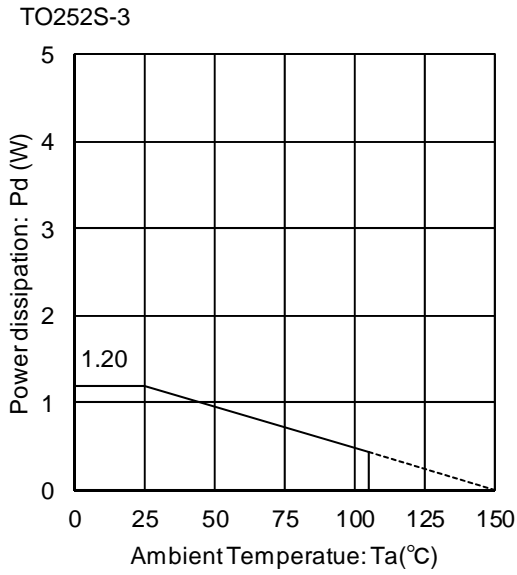

Figure 25.

Mounted on a Rohm standard board
 Board size : 70mm × 70 mm × 1.6 mm
 Copper foil area : 7mm × 7mm

TO252S-3 $\theta_{ja}=104.2(^{\circ}\text{C}/\text{W})$

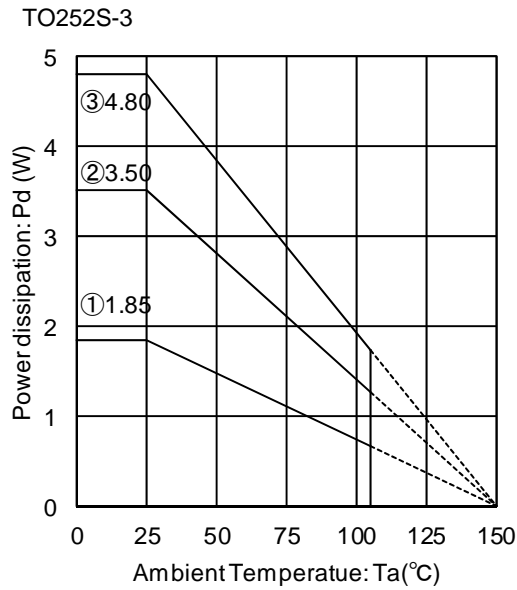

Figure 26.

IC mounted on a ROHM standard board
 Board size : 70mm×70mm×1.6mm
 Copper area : 7mm×7mm

- ①:2-layer PCB
 (Copper foil area on the reverse side of PCB:15mm×15mm)
- ②:2-layer PCB
 (Copper foil area on the reverse side of PCB:70mm×70mm)
- ③:4-layer PCB
 (Copper foil on the reverse side of PCB:70mm×70mm)

- ①: $\theta_{ja}=67.6^{\circ}\text{C}/\text{W}$
- ②: $\theta_{ja}=35.7^{\circ}\text{C}/\text{W}$
- ③: $\theta_{ja}=26.0^{\circ}\text{C}/\text{W}$

When used at temperatures over $T_a=25^{\circ}\text{C}$, please refer to the power dissipation curve shown in Figure 25 and Figure 26. The IC characteristics are closely related to the temperature at which the IC is used, so it is necessary to operate the IC at temperatures less than the maximum junction temperature $T_{j\text{max}}$.

Figure 25 and Figure 26 show the acceptable power dissipation curve of the TO252S-3 package. Even when the ambient temperature T_a is at normal temperature (25°C), the chip (junction) temperature T_j may be quite high, so please operate the IC at temperature less than the acceptable power dissipation P_d .

The calculation method for power consumption $P_c(\text{W})$ is as follows : (Figure 26③)

$$P_c = (V_{cc} - V_o) \times I_o + V_{cc} \times I_b$$

Acceptable loss $P_d \geq P_c$

V_{cc} : Input voltage
 V_o : Output voltage
 I_o : Load current
 I_b : Circuit current
 I_{short} : Short current

Solving this for load current I_o in order to operate within the acceptable power dissipation,

$$I_o \leq \frac{P_d - V_{cc} \times I_b}{V_{cc} - V_o}$$

(Please refer to Figure 11, Figure 20 for I_b .)

It is then possible to find the maximum load current $I_{o\text{Max}}$ with respect to the applied voltage V_{cc} at the time of thermal design.

Calculation Example for BD80C0AFPS-M)

When $T_a=85^{\circ}\text{C}$, $V_{cc}=13\text{V}$, $V_o=8\text{V}$

$$I_o \leq \frac{2.496 - 13 \times I_b}{5}$$

(Figure 26③ : $\theta_{ja}=26.0^{\circ}\text{C/W} \rightarrow -38.4\text{mW}/^{\circ}\text{C}$
 $25^{\circ}\text{C}=4.80\text{W} \rightarrow 85^{\circ}\text{C}=2.496\text{W}$)

$$I_o \leq 497.6\text{mA} \quad (I_b: 0.6\text{mA})$$

Please refer to the above information and keep thermal designs within the scope of acceptable loss for all operating temperature ranges. The power consumption P_c of the IC when there is a short circuit (short between V_o and GND) is :

$$P_c = V_{cc} \times (I_b + I_{\text{short}}) \quad (\text{Please refer to Figure 7, Figure 16 for } I_{\text{short}}.)$$

● Input / Output Equivalent Circuit Diagrams

V_{cc} terminal

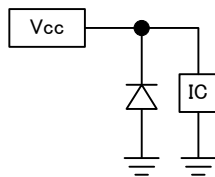

V_o terminal

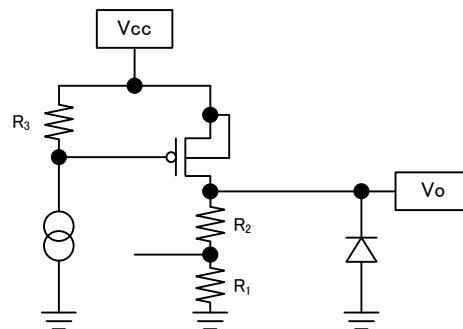

| | R_1 (k Ω) | R_2 (k Ω) | R_3 (k Ω) |
|--------------|------------------------|------------------------|------------------------|
| BD80C0AFPS-M | 5 | 48.3 | 20 |
| BD90C0AFPS-M | | 55 | |

●Operational Notes

1. Absolute maximum ratings
Exceeding the absolute maximum rating for supply voltage, operating temperature or other parameters can result in damages to or destruction of the chip. In this event it also becomes impossible to determine the cause of the damage (e.g. short circuit, open circuit, etc). Therefore, if any special mode is being considered with values expected to exceed the absolute maximum ratings, implementing physical safety measures, such as adding fuses, should be considered.
2. The electrical characteristics given in this specification may be influenced by conditions such as temperature, supply voltage and external components. Transient characteristics should be sufficiently verified..
3. GND electric potential
Keep the GND pin potential at the lowest (minimum) level under any operating condition. Furthermore, ensure that, including the transient, none of the pin's voltages are less than the GND pin voltage.
4. Ground wiring pattern
When both a small-signal GND and a high current GND are present, single-point grounding (at the set standard point) is recommended. This in order to separate the small-signal and high current patterns and to ensure that voltage changes stemming from the wiring resistance and high current do not cause any voltage change in the small-signal GND. Similarly, care must be taken to avoid wiring pattern fluctuations in any connected external component GND.
5. Inter-pin shorting and mounting errors
Ensure that when mounting the IC on the PCB the direction and position are correct. Incorrect mounting may result in damaging the IC. Also, shorts caused by dust entering between the output, input and GND pin may result in damaging the IC.
6. Operation Under Strong Electromagnetic Field
Operating the IC in the presence of a strong electromagnetic field may cause the IC to malfunction.
7. Inspection using the set board
The IC needs to be discharged after each inspection process as, while using the set board for inspection, connecting a capacitor to a low-impedance pin may cause stress to the IC. As a protection from static electricity, ensure that the assembly setup is grounded and take sufficient caution with transportation and storage. Also, make sure to turn off the power supply when connecting and disconnecting the inspection equipment.
8. Power dissipation (Pd)
Should by any chance the power dissipation rating be exceeded the rise in temperature of the chip may result in deterioration of the properties of the chip. The absolute maximum rating of the Pd stated in this specification is when the IC is mounted on a 70mm X 70mm X 1.6mm glass epoxy board. In case of exceeding this absolute maximum rating, increase the board size and copper area to prevent exceeding the Pd rating.
9. Thermal design
The power dissipation under actual operating conditions should be taken into consideration and a sufficient margin should be allowed for in the thermal design. On the reverse side of the package this product has an exposed heat pad for improving the heat dissipation. Use both the front and reverse side of the PCB to increase the heat dissipation pattern as far as possible. The amount of heat generated depends on the voltage difference across the input and output, load current, and bias current. Therefore, when actually using the chip, ensure that the generated heat does not exceed the Pd rating.

$$\left(\begin{array}{l} T_{jmax}: \text{Maximum junction temperature}=150[^\circ\text{C}], T_a: \text{Peripheral temperature } [^\circ\text{C}], \\ \theta_{ja} : \text{Thermal resistance of package-ambience}[^\circ\text{C}/\text{W}], P_d : \text{Package Power dissipation } [\text{W}], \\ P_c: \text{Power dissipation } [\text{W}], V_{cc}: \text{Input Voltage}, V_o: \text{Output Voltage}, I_o: \text{Load}, I_b : \text{Circuit Current} \end{array} \right)$$

Package Power dissipation : $P_d (W) = (T_{jmax}-T_a) / \theta_{ja}$
 Power dissipation : $P_c (W) = (V_{cc}-V_o) \times I_o + V_{cc} \times I_b$

10. Vcc pin
Insert a capacitor with a capacitance of 1μF or higher between the Vcc and GND pins. Choose the capacitance according to the line between the power smoothing circuit and the Vcc pin. Selection of the capacitance also depends on the application. Verify the application and allow for sufficient margins in the design. We recommend using a capacitor with excellent voltage and temperature characteristics.

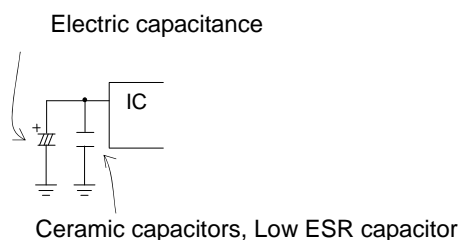

11. Output pin

In order to prevent oscillation, a capacitor needs to be placed between the output pin and GND pin. We recommend a capacitor with a capacitance of more than 1μF. Electrolytic, tantalum and ceramic capacitors can be used. When selecting the capacitor ensure that the capacitance of more than 1μF is maintained at the intended applied voltage and temperature range. Due to changes in temperature, the capacitance can fluctuate possibly resulting in oscillation. For selection of the capacitor refer to the Cout ESR vs. Io. The stable operation range given in the reference data is based on the standalone IC and resistive load. For actual applications the stable operating range is influenced by the PCB impedance, input supply impedance and load impedance. Therefore verification of the final operating environment is needed.

When selecting a ceramic type capacitor, we recommend using X5R, X7R or better with excellent temperature and DC-biasing characteristics and high voltage tolerance.

Also, in case of rapidly changing input voltage and load current, select the capacitance in accordance with verifying that the actual application meets with the required specification.

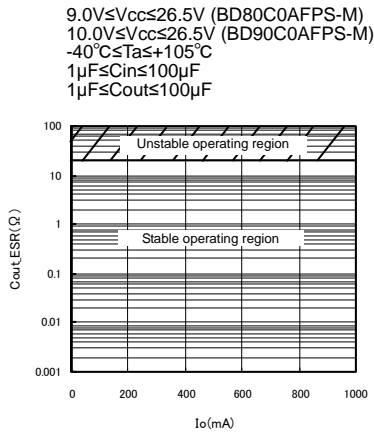

Cout_ESR vs Io(reference data)

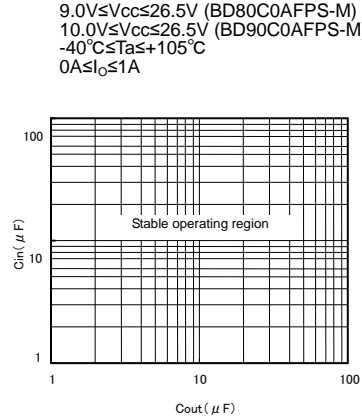

Cin vs Cout(reference data)

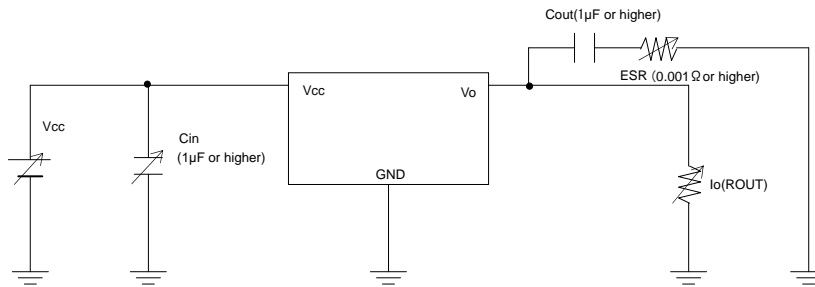

※Operation Note 11 Measurement circuit

12. Rapid variation in Vcc voltage and load current

In case of a rapidly changing input voltage, transients in the output voltage might occur due to the use of a MOSFET as output transistor. Although the actual application might be the cause of the transients, the IC input voltage, output current and temperature are also possible causes. In case problems arise within the actual operating range, use countermeasures such as adjusting the output capacitance.

13. Minute variation in output voltage

In case of using an application susceptible to minute changes to the output voltage due to noise, changes in input and load current, etc., use countermeasures such as implementing filters.

14. Over current protection circuit (OCP)

This IC incorporates an integrated overcurrent protection circuit that is activated when the load is shorted. This protection circuit is effective in preventing damage due to sudden and unexpected incidents. However, the IC should not be used in applications characterized by continuous operation or transitioning of the protection circuit.

15. Thermal shutdown circuit (TSD)

This IC incorporates an integrated thermal shutdown circuit to prevent heat damage to the IC. Normal operation should be within the power dissipation rating, if however the rating is exceeded for a continued period, the junction temperature (T_j) will rise and the TSD circuit will be activated and turn all output pins OFF. After the T_j falls below the TSD threshold the circuits are automatically restored to normal operation.

Note that the TSD circuit operates in a situation that exceeds the absolute maximum ratings and therefore, under no circumstances, should the TSD circuit be used in a set design or for any purpose other than protecting the IC from heat damage.

16. In some applications, the Vcc and pin potential might be reversed, possibly resulting in circuit internal damage or damage to the elements. For example, while the external capacitor is charged, the Vcc shorts to the GND. Use a capacitor with a capacitance with less than 1000 μ F. We also recommend using reverse polarity diodes in series or a bypass between all pins and the Vcc pin.

17. This monolithic IC contains P+ isolation and P substrate layers between adjacent elements in order to keep them isolated. P/N junctions are formed at the intersection of these P layers with the N layers of other elements to create a variety of parasitic elements.

For example, in case a resistor and a transistor are connected to the pins as shown in the figure below then:

- The P/N junction functions as a parasitic diode when $GND > \text{pin A}$ for the resistor, or $GND > \text{pin B}$ for the transistor.
- Also, when $GND > \text{pin B}$ for the transistor (NPN), the parasitic diode described above combines with the N layer of the other adjacent elements to operate as a parasitic NPN transistor.

Parasitic diodes inevitably occur in the structure of the IC. Their operation can result in mutual interference between circuits and can cause malfunctions and, in turn, physical damage to or destruction of the chip. Therefore do not employ any method in which parasitic diodes can operate such as applying a voltage to an input pin that is lower than the (P substrate) GND.

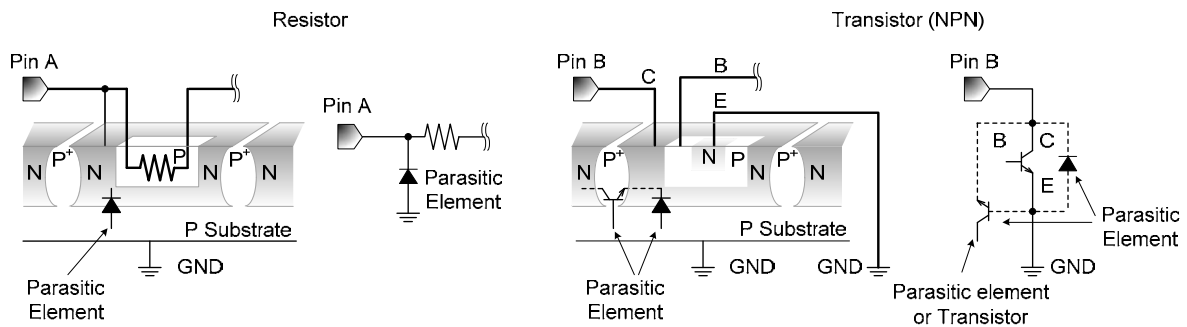

●Marking Diagrams

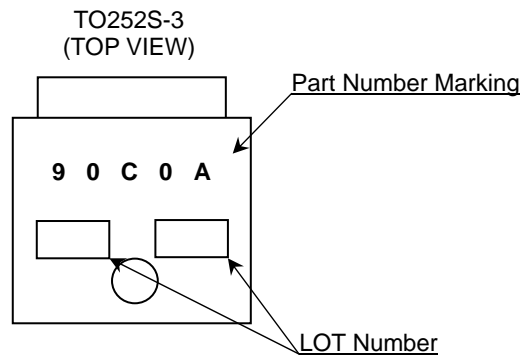
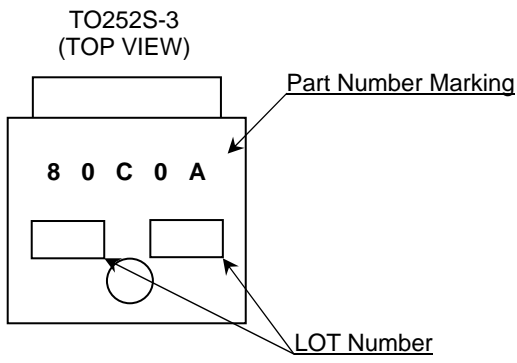

●Physical Dimension, Tape and Reel Information

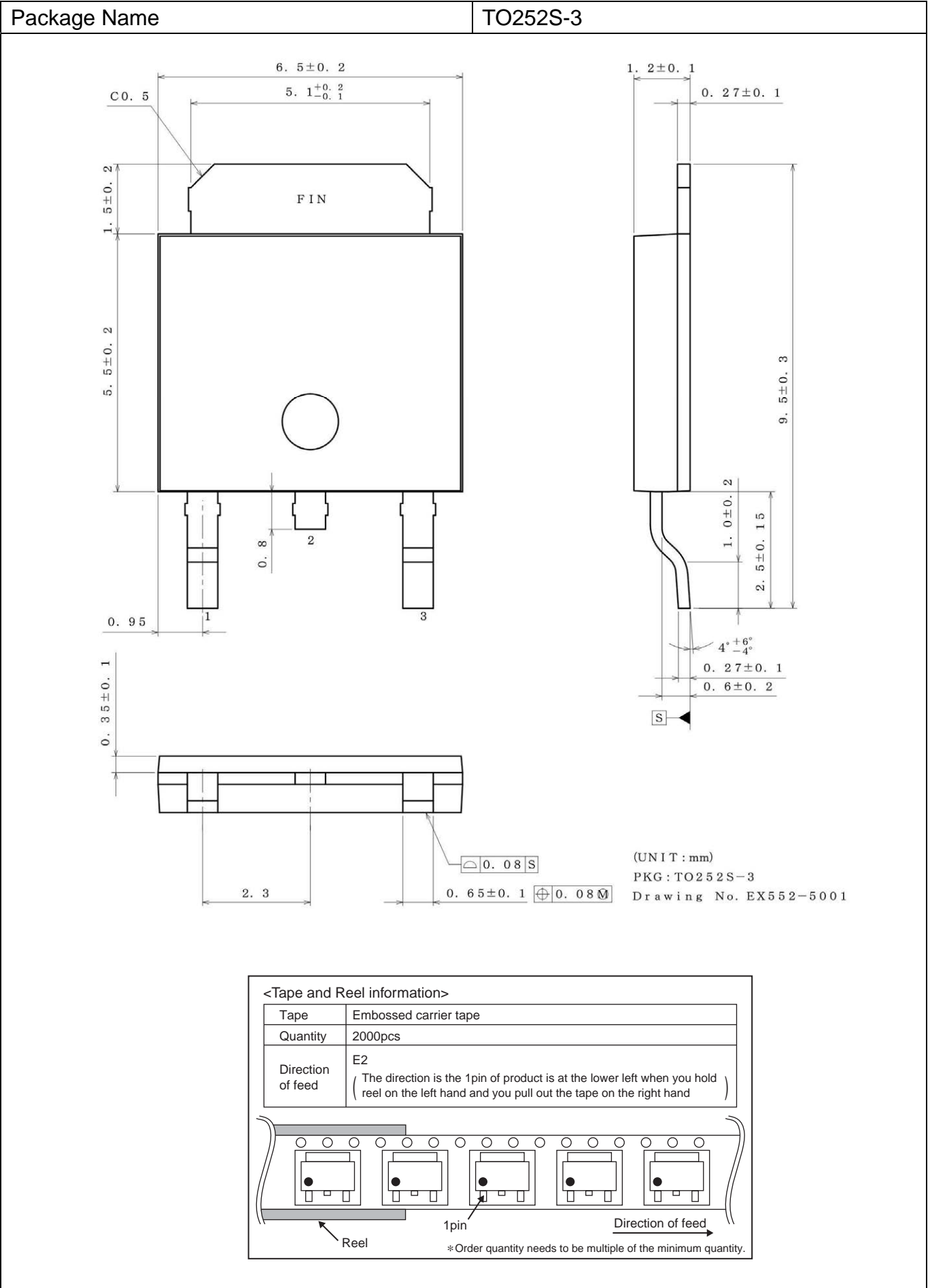

●Revision History

| Date | Revision | Changes |
|-------------|----------|-----------------------------|
| 21.Feb.2013 | 001 | New Release |
| 14.Nov.2013 | 002 | "AEC-Q100 Qualified" Added. |

Notice

Precaution on using ROHM Products

1. If you intend to use our Products in devices requiring extremely high reliability (such as medical equipment ^(Note 1), aircraft/spacecraft, nuclear power controllers, etc.) and whose malfunction or failure may cause loss of human life, bodily injury or serious damage to property ("Specific Applications"), please consult with the ROHM sales representative in advance. Unless otherwise agreed in writing by ROHM in advance, ROHM shall not be in any way responsible or liable for any damages, expenses or losses incurred by you or third parties arising from the use of any ROHM's Products for Specific Applications.

(Note1) Medical Equipment Classification of the Specific Applications

| JAPAN | USA | EU | CHINA |
|-----------|-----------|------------|-----------|
| CLASS III | CLASS III | CLASS II b | CLASS III |
| CLASS IV | | CLASS III | |

2. ROHM designs and manufactures its Products subject to strict quality control system. However, semiconductor products can fail or malfunction at a certain rate. Please be sure to implement, at your own responsibilities, adequate safety measures including but not limited to fail-safe design against the physical injury, damage to any property, which a failure or malfunction of our Products may cause. The following are examples of safety measures:
 - [a] Installation of protection circuits or other protective devices to improve system safety
 - [b] Installation of redundant circuits to reduce the impact of single or multiple circuit failure
3. Our Products are not designed under any special or extraordinary environments or conditions, as exemplified below. Accordingly, ROHM shall not be in any way responsible or liable for any damages, expenses or losses arising from the use of any ROHM's Products under any special or extraordinary environments or conditions. If you intend to use our Products under any special or extraordinary environments or conditions (as exemplified below), your independent verification and confirmation of product performance, reliability, etc, prior to use, must be necessary:
 - [a] Use of our Products in any types of liquid, including water, oils, chemicals, and organic solvents
 - [b] Use of our Products outdoors or in places where the Products are exposed to direct sunlight or dust
 - [c] Use of our Products in places where the Products are exposed to sea wind or corrosive gases, including Cl₂, H₂S, NH₃, SO₂, and NO₂
 - [d] Use of our Products in places where the Products are exposed to static electricity or electromagnetic waves
 - [e] Use of our Products in proximity to heat-producing components, plastic cords, or other flammable items
 - [f] Sealing or coating our Products with resin or other coating materials
 - [g] Use of our Products without cleaning residue of flux (even if you use no-clean type fluxes, cleaning residue of flux is recommended); or Washing our Products by using water or water-soluble cleaning agents for cleaning residue after soldering
 - [h] Use of the Products in places subject to dew condensation
4. The Products are not subject to radiation-proof design.
5. Please verify and confirm characteristics of the final or mounted products in using the Products.
6. In particular, if a transient load (a large amount of load applied in a short period of time, such as pulse. is applied, confirmation of performance characteristics after on-board mounting is strongly recommended. Avoid applying power exceeding normal rated power; exceeding the power rating under steady-state loading condition may negatively affect product performance and reliability.
7. De-rate Power Dissipation (Pd) depending on Ambient temperature (Ta). When used in sealed area, confirm the actual ambient temperature.
8. Confirm that operation temperature is within the specified range described in the product specification.
9. ROHM shall not be in any way responsible or liable for failure induced under deviant condition from what is defined in this document.

Precaution for Mounting / Circuit board design

1. When a highly active halogenous (chlorine, bromine, etc.) flux is used, the residue of flux may negatively affect product performance and reliability.
2. In principle, the reflow soldering method must be used; if flow soldering method is preferred, please consult with the ROHM representative in advance.

For details, please refer to ROHM Mounting specification

Precautions Regarding Application Examples and External Circuits

1. If change is made to the constant of an external circuit, please allow a sufficient margin considering variations of the characteristics of the Products and external components, including transient characteristics, as well as static characteristics.
2. You agree that application notes, reference designs, and associated data and information contained in this document are presented only as guidance for Products use. Therefore, in case you use such information, you are solely responsible for it and you must exercise your own independent verification and judgment in the use of such information contained in this document. ROHM shall not be in any way responsible or liable for any damages, expenses or losses incurred by you or third parties arising from the use of such information.

Precaution for Electrostatic

This Product is electrostatic sensitive product, which may be damaged due to electrostatic discharge. Please take proper caution in your manufacturing process and storage so that voltage exceeding the Products maximum rating will not be applied to Products. Please take special care under dry condition (e.g. Grounding of human body / equipment / solder iron, isolation from charged objects, setting of ionizer, friction prevention and temperature / humidity control).

Precaution for Storage / Transportation

1. Product performance and soldered connections may deteriorate if the Products are stored in the places where:
 - [a] the Products are exposed to sea winds or corrosive gases, including Cl₂, H₂S, NH₃, SO₂, and NO₂
 - [b] the temperature or humidity exceeds those recommended by ROHM
 - [c] the Products are exposed to direct sunshine or condensation
 - [d] the Products are exposed to high Electrostatic
2. Even under ROHM recommended storage condition, solderability of products out of recommended storage time period may be degraded. It is strongly recommended to confirm solderability before using Products of which storage time is exceeding the recommended storage time period.
3. Store / transport cartons in the correct direction, which is indicated on a carton with a symbol. Otherwise bent leads may occur due to excessive stress applied when dropping of a carton.
4. Use Products within the specified time after opening a humidity barrier bag. Baking is required before using Products of which storage time is exceeding the recommended storage time period.

Precaution for Product Label

QR code printed on ROHM Products label is for ROHM's internal use only.

Precaution for Disposition

When disposing Products please dispose them properly using an authorized industry waste company.

Precaution for Foreign Exchange and Foreign Trade act

Since our Products might fall under controlled goods prescribed by the applicable foreign exchange and foreign trade act, please consult with ROHM representative in case of export.

Precaution Regarding Intellectual Property Rights

1. All information and data including but not limited to application example contained in this document is for reference only. ROHM does not warrant that foregoing information or data will not infringe any intellectual property rights or any other rights of any third party regarding such information or data. ROHM shall not be in any way responsible or liable for infringement of any intellectual property rights or other damages arising from use of such information or data.:
2. No license, expressly or implied, is granted hereby under any intellectual property rights or other rights of ROHM or any third parties with respect to the information contained in this document.

Other Precaution

1. This document may not be reprinted or reproduced, in whole or in part, without prior written consent of ROHM.
2. The Products may not be disassembled, converted, modified, reproduced or otherwise changed without prior written consent of ROHM.
3. In no event shall you use in any way whatsoever the Products and the related technical information contained in the Products or this document for any military purposes, including but not limited to, the development of mass-destruction weapons.
4. The proper names of companies or products described in this document are trademarks or registered trademarks of ROHM, its affiliated companies or third parties.

General Precaution

1. Before you use our Products, you are requested to carefully read this document and fully understand its contents. ROHM shall not be in any way responsible or liable for failure, malfunction or accident arising from the use of any ROHM's Products against warning, caution or note contained in this document.
2. All information contained in this document is current as of the issuing date and subject to change without any prior notice. Before purchasing or using ROHM's Products, please confirm the latest information with a ROHM sales representative.
3. The information contained in this document is provided on an "as is" basis and ROHM does not warrant that all information contained in this document is accurate and/or error-free. ROHM shall not be in any way responsible or liable for any damages, expenses or losses incurred by you or third parties resulting from inaccuracy or errors of or concerning such information.