

### Intellimod™ Module Application Specific IPM 15 Amperes/1200 Volts

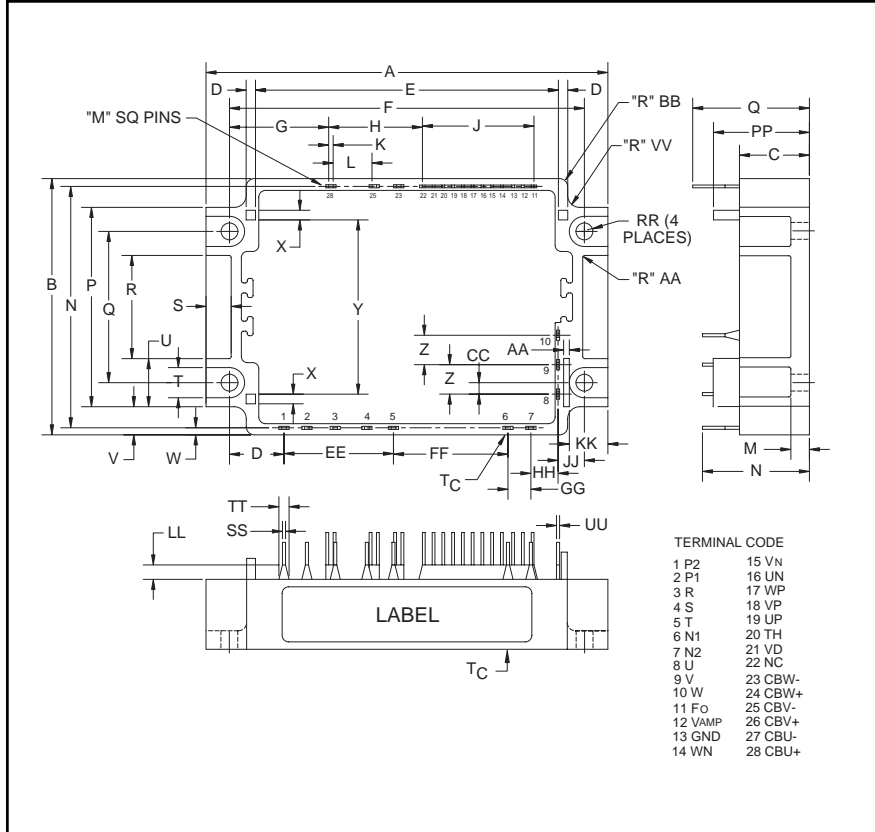

Outline Drawing and Circuit Diagram

| Dimensions | Inches        | Millimeters  |
|------------|---------------|--------------|
| A          | 4.06 +0/-0.02 | 103.0+0/-0.4 |
| B          | 2.87 +0/-0.02 | 73.0 +0/-0.4 |
| C          | 0.35          | 9.0          |
| D          | 0.10          | 2.5          |
| E          | 3.11          | 79.0         |
| F          | 3.74±0.01     | 95±0.2       |
| G          | 1.32          | 33.5         |
| H          | 0.95          | 24.0         |
| J          | 0.87          | 22.0         |
| K          | 0.08          | 2.0          |
| L          | 0.24          | 6.0          |
| M          | 0.02 Sq.      | 0.5 Sq.      |
| N          | 2.72          | 69.0         |
| P          | 2.13          | 54.0         |
| Q          | 1.54±0.01     | 39.0±0.2     |
| R          | 0.95          | 24.0         |
| S          | 0.26          | 6.5          |
| T          | 0.35          | 9.0          |
| U          | 0.59          | 15.0         |
| V          | 0.37          | 9.5          |
| W          | 0.08          | 2.0          |
| X          | 0.12          | 3.0          |

| Dimensions | Inches    | Millimeters |
|------------|-----------|-------------|
| Y          | 1.81      | 46.0        |
| Z          | 0.30      | 7.62        |
| AA         | 0.08 Rad. | 2.0 Rad.    |
| BB         | 0.04 Rad. | 1.0 Rad.    |
| CC         | 0.14      | 3.5         |
| DD         | 0.47      | 12.0        |
| EE         | 1.20      | 30.48       |
| FF         | 0.90      | 22.86       |
| GG         | 0.30      | 7.62        |
| HH         | 0.51      | 13.4        |
| JJ         | 0.35      | 9.0         |
| KK         | 0.34      | 8.5         |
| LL         | 0.08      | 2.0         |
| MM         | 0.12      | 3.0         |
| NN         | 0.67      | 17.0        |
| PP         | 0.49      | 12.5        |
| QQ         | 0.80      | 20.4        |
| RR         | 0.16      | 4.0         |
| SS         | 0.06      | 1.4         |
| TT         | 0.12      | 3.0         |
| UU         | 0.04      | 1.0         |
| VV         | 0.16      | 4.0         |

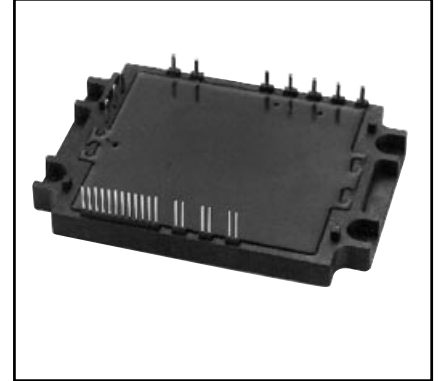

#### Description:

Powerex Application Specific IPMs (ASIPMs) are intelligent power modules that integrate power devices, gate drive and protection circuitry in a compact package for use in small inverter applications up to 20kHz. Use of application specific HVICs allow the designer to reduce inverter size and overall design time.

#### Features:

- Rectifier Bridge for 3-phase AC-to-DC Power Conversion
- 3-phase IGBT Inverter Bridge
- Integrated HVICs for Gate Drive, Protection and System Control Functions
- Built-in Thermistor
- Direct Connection to DSP/CPU

#### Applications:

- Smart Motors
- General Purpose Inverters
- Small Motor Control

#### Ordering Information:

PS12036 is a 1200V, 15 Ampere Application Specific Power Module.

**PS12036**  
**Intellimod™ Module**  
**Application Specific IPM**  
 15 Amperes/1200 Volts

### Absolute Maximum Ratings, $T_j = 25^\circ\text{C}$ unless otherwise specified

| Characteristics   | Symbol           | PS12036    | Units            |
|---|------------------|------------|------------------|
| Power Device Junction Temperature*                                | $T_j$            | -20 to 125 | $^\circ\text{C}$ |
| Storage Temperature   | $T_{\text{stg}}$ | -40 to 125 | $^\circ\text{C}$ |
| Case Operating Temperature (See $T_C$ Measure Point Illustration) | $T_C$            | -20 to 100 | $^\circ\text{C}$ |
| Mounting Torque, M3.5 Mounting Screws                             | —                | 11.25      | in-lb            |
| Module Weight (Typical)   | —                | 127        | Grams            |
| Isolation Voltage**   | $V_{\text{ISO}}$ | 2500       | Volts            |

\*The indicated values are specified considering the safe operation of all the parts within the ASIPM. The maximum rating for the ASIPM power chips (IGBT & FWDI) is  $T_j < 150$ .

\*\*60 Hz sinusoidal AC applied between all terminals and the base plate for 1 minute.

### IGBT Inverter Sector

|   |                            |                       |         |
|---|----------------------------|-----------------------|---------|
| Supply Voltage (Applied between P2 - N2)  | $V_{\text{CC}}$            | 900                   | Volts   |
| Supply Voltage, Surge (Applied between P2 - N2, Surge-Value)                                  | $V_{\text{CC(surge)}}$     | 1000                  | Volts   |
| Each IGBT Collector-Emitter Static Voltage (Applied between P2-U·V·W, U·V·W-N2)               | $V_P$ or $V_N$             | 1200                  | Volts   |
| Each IGBT Collector-Emitter Switching Voltage<br>(Applied between P2-U·V·W, U·V·W-N2 (Pulse)) | $V_{P(S)}$ or $V_{N(S)}$   | 1200                  | Volts   |
| Each IGBT Collector Current, $T_C = 25^\circ\text{C}$ , "( )" means $I_C$ Peak Value          | $\pm I_C$ ( $\pm I_{CP}$ ) | $\pm 15$ ( $\pm 30$ ) | Amperes |

### Converter Sector

|   |                  |      |                      |
|---|------------------|------|----------------------|
| Repetitive Peak Reverse Voltage   | $V_{\text{RRM}}$ | 1600 | Volts                |
| Recommended AC Input Voltage  | $E_a$            | 440  | Vrms                 |
| DC Output Current (3-phase Rectifying Circuit)                                      | $I_O$            | 12   | A                    |
| Surge (Non-repetitive) Forward Current (1 Cycle at 60Hz, Peak Value Non-repetitive) | $I_{\text{FSM}}$ | 120  | A                    |
| $I^2t$ for Fusing (Value for One Cycle of Surge Current)                            | $I^2t$           | 60   | $\text{A}^2\text{s}$ |

### Control Sector

|  |                      |            |       |
|--|----------------------|------------|-------|
| Supply Voltage                                 | $V_D, V_{\text{DB}}$ | -0.5 ~ 20  | Volts |
| Input Signal Voltage                           | $V_{\text{CIN}}$     | -0.5 ~ 7.5 | Volts |
| Fault Output Supply Voltage                    | $V_{\text{FO}}$      | -0.5 ~ 7.5 | Volts |
| Fault Output Current                           | $I_{\text{FO}}$      | 15         | mA    |
| DC-link IGBT Current Signal Amp Output Current | $I_{\text{AMP}}$     | 1          | mA    |

**PS12036**  
**Intellimod™ Module**  
**Application Specific IPM**  
 15 Amperes/1200 Volts

## Electrical and Mechanical Characteristics, $T_j = 25^\circ\text{C}$ unless otherwise specified

| Characteristics   | Symbol        | Test Conditions  | Min. | Typ. | Max. | Units   |
|---|---------------|--|------|------|------|---|
| <b>IGBT Inverter Sector</b>   |               |  |      |      |      |   |
| Collector-Emitter Saturation Voltage                                | $V_{CE(sat)}$ | $I_C = 15\text{A}$ , $T_j = 25^\circ\text{C}$ , $V_D = V_{DB} = 15\text{V}$ ,<br>Input = ON (Shunt Voltage Drop Not Included)  | —    | —    | 3.6  | Volts   |
| Diode Forward Voltage   | $V_{EC}$      | $T_j = 25^\circ\text{C}$ , $-I_C = 15\text{A}$   | —    | —    | 3.5  | Volts   |
| Converter Diode Voltage   | $V_{FR}$      | $T_j = 25^\circ\text{C}$ , $I_{FR} = 12\text{A}$   | —    | —    | 1.7  | Volts   |
| Converter Diode Reverse Current                                     | $I_{RRM}$     | $V_R = V_{RRM}$ , $T_j = 125^\circ\text{C}$  | —    | —    | 8.0  | mA  |
| Switching Times   | $t_{on}$      | 1/2 Bridge Inductive, Input = $5\text{V} \leftrightarrow 0\text{V}$ ,  | 0.3  | 1.2  | 2.0  | $\mu\text{S}$   |
|   | $t_{C(on)}$   | $V_{CC} = 600\text{V}$ , $I_C = 15\text{A}$ , $T_j = 125^\circ\text{C}$ ,  | —    | 0.5  | 1.4  | $\mu\text{S}$   |
|   | $t_{off}$     | $V_D = 15\text{V}$ , $V_{DB} = 15\text{V}$   | —    | 2.2  | 4.0  | $\mu\text{S}$   |
|   | $t_{C(off)}$  | Note: $t_{on}$ , $t_{off}$ include delay time of<br>the internal control circuit.  | —    | 0.9  | 1.6  | $\mu\text{S}$   |
| FWDi Reverse Recovery Time  | $t_{rr}$      |  | —    | 0.2  | —    | $\mu\text{S}$   |
| Short-circuit Endurance (Output, Arm, and Load Short-circuit Modes) |               | @ $V_{CC} \leq 800\text{V}$ , Input = $5\text{V} \rightarrow 0\text{V}$ (One-shot),<br>$-20^\circ\text{C} \leq T_{j(\text{start})} \leq 125^\circ\text{C}$ ,<br>$13.5\text{V} \leq V_D = V_{DB} \leq 16.5\text{V}$ |      |      |      | <ul style="list-style-type: none"> <li>• No Destruction</li> <li>• <math>F_O</math> Output by Protection Operation</li> </ul>               |
| Switching SOA   |               | @ $V_{CC} \leq 800\text{V}$ , Input = $5\text{V} \rightarrow 0\text{V}$ ,<br>$T_j \leq 150^\circ\text{C}$ , $I_C < \text{OC Trip Level}$ ,<br>$13.5\text{V} \leq V_D = V_{DB} \leq 16.5\text{V}$                   |      |      |      | <ul style="list-style-type: none"> <li>• No Destruction</li> <li>• No Protecting Operation</li> <li>• No <math>F_O</math> Output</li> </ul> |

$T_C$  Measure Point

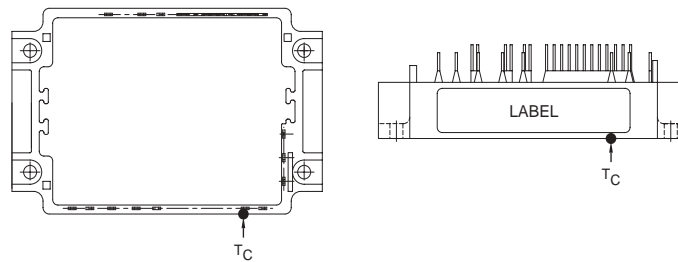

**PS12036**  
**Intellimod™ Module**  
**Application Specific IPM**  
 15 Amperes/1200 Volts

## Electrical and Mechanical Characteristics, $T_j = 25^\circ\text{C}$ unless otherwise specified

| Characteristics                  | Symbol          | Test Conditions   | Min. | Typ.  | Max.  | Units         |
|----------------------------------|-----------------|---|------|-------|-------|---------------|
| <b>Control Sector</b>            |                 |   |      |       |       |               |
| Circuit Current (Average)        | $I_D$           | $T_j = 25^\circ\text{C}, V_D = 15\text{V}, V_{IN} = 5\text{V}$                      | —    | —     | 50    | mA            |
|                                  | $I_{DB}$        | $T_j = 25^\circ\text{C}, V_D = V_{DB} = 15\text{V}, V_{IN} = 5\text{V}$             | —    | —     | 5     | mA            |
| Input ON Threshold Voltage       | $V_{th(on)}$    |   | 0.8  | 1.4   | 2.0   | Volts         |
| Input OFF Threshold Voltage      | $V_{th(off)}$   |   | 2.5  | 3.0   | 4.0   | Volts         |
| Input Pull-up Resistor           | $R_i$           | Applied between<br>Input Terminal-inside Power Supply                               | —    | 50    | —     | $k\Omega$     |
| PWM Input Frequency              | $f_{PWM}$       | $T_C \leq 100^\circ\text{C}, T_j \leq 125^\circ\text{C}$                            | —    | 10    | 15    | kHz           |
| Arm Shoot-through Blocking Time* | $t_{DEAD}$      | Relates to Corresponding Inputs<br>$T_C = -20^\circ\text{C} \sim 100^\circ\text{C}$ | 4.0  | —     | —     | $\mu\text{S}$ |
| Input Interlock Sensing          | $t_{int}$       | Relates to Corresponding Input  | —    | 100   | —     | ns            |
| Inverter DC-link IGBT Current    | $V_{amp} 100\%$ | $I_C = I_{OP(100\%)}, V_D = 15\text{V}, T_j = 25^\circ\text{C}$                     | 1.5  | 2.0   | 2.5   | Volts         |
| Sense Voltage Output Signal**    | $V_{amp} 200\%$ | $I_C = I_{OP(200\%)}, V_D = 15\text{V}, T_j = 25^\circ\text{C}$                     | 3.0  | 4.0   | 5.0   | Volts         |
| Inverter DC-link IGBT Current    | $V_{amp} 250\%$ | $I_C = I_{OP(250\%)}, V_D = 15\text{V}$   | 5.0  | —     | —     | Volts         |
| Sense Voltage Output Limit**     | $V_{amp} 0\%$   | $I_C = I_{OP(0\%)}, V_D = 15\text{V}$   | —    | 50    | 100   | mV            |
| Over-current Trip Level          | OC              |   | 23.3 | 28.3  | —     | Amperes       |
| Over-current Delay Time          | $t_{OC}$        | $T_j = 25^\circ\text{C}$  | —    | 10    | —     | $\mu\text{S}$ |
| Short-circuit Trip Level         | SC              |   | —    | 42.45 | —     | Amperes       |
| Short-circuit Delay Time         | $t_{SC}$        |   | —    | 2     | —     | $\mu\text{s}$ |
| Supply Circuit                   | Trip Level      | $UV_D$  | 11.0 | 12.0  | 12.75 | Volts         |
|                                  | Reset Level     | $UV_{Dr}$   | 11.5 | 12.5  | 13.25 | Volts         |
| Under-voltage                    | Trip Level      | $UV_{DB}$   | 10.1 | 10.8  | 11.6  | Volts         |
| Protection                       | Reset Level     | $UV_{DBr}$  | 10.6 | 11.3  | 12.1  | Volts         |
|                                  | Delay Time      | $t_{dV}$  | —    | 10    | —     | $\mu\text{S}$ |
| Fault Output Pulse Width***      | $t_{FO}$        | $T_j = 25^\circ\text{C}$  | 1.0  | 1.8   | —     | mS            |
| Fault Output Current***          | $I_{Fo(H)}$     | Open Collector Output   | —    | —     | 1     | $\mu\text{A}$ |
|                                  | $I_{Fo(L)}$     |   | —    | —     | 15    | mA            |
| Thermistor Resistance            | $R_{TO}$        | $T_O = 25^\circ\text{C} (298\text{K})$  | 9.5  | 10    | 10.5  | $k\Omega$     |
| Material Constant****            | $\beta$         | $T_1 = 25^\circ\text{C}, T_2 = 50^\circ\text{C}$                                    | —    | 3450  | —     | K             |

\* The dead-time has to be set externally by the CPU; it is not part of the ASIPM internal functions.

\*\*Refer to the graph on next page.

\*\*\*Fault output signalling is given only when the internal OC, SC, and UV protection circuits are activated. The OC, SC and UV protection (and fault output) operate for the lower arms only. The OC and SC protection fault output is given in a pulse format while that of UV protection is maintained throughout the duration of the under-voltage condition.

$$****T = \frac{1}{\frac{1}{\beta} \cdot \ln \left[ \frac{R_T}{R_{TO}} \right] + \frac{1}{T_O}}$$

**PS12036**  
**Intellimod™ Module**  
**Application Specific IPM**  
 15 Amperes/1200 Volts

## Thermal Characteristics

| Characteristic             | Symbol          | Condition   | Min. | Typ. | Max. | Units   |
|----------------------------|-----------------|---|------|------|------|---------|
| Junction to Case           | $R_{th(j-c)Q}$  | Each IGBT   | —    | —    | 2.1  | °C/Watt |
|                            | $R_{th(j-c)D}$  | Each FWDi   | —    | —    | 2.5  | °C/Watt |
|                            | $R_{th(j-c)DR}$ | Each Converter                                    | —    | —    | 2.5  | °C/Watt |
| Contact Thermal Resistance | $R_{th(c-f)}$   | Case to Fin Per Module.<br>Thermal Grease Applied | —    | —    | 0.05 | °C/Watt |

## Recommended Conditions for Use

| Characteristic                         | Symbol                | Condition  | Min. | Typ. | Value | Units |
|--|-----------------------|--|------|------|-------|-------|
| Supply Voltage                         | $V_{CC}$              | Applied across P2-N2 Terminals                           | —    | 600  | 800   | Volts |
| Control Supply Voltage                 | $V_D$                 | Applied between $V_D$ -GND                               | 13.5 | 15.0 | 16.5  | Volts |
|  | $V_{DB}$              | Applied between CBU+ & CBU-,<br>CBV+ & CBV-, CBW+ & CBW- | 13.5 | 15.0 | 16.5  | Volts |
| Control Supply dv/dt                   | $dV_D/dt, dV_{DB}/dt$ |  | -1   | —    | 1     | V/μs  |
| Input ON Voltage                       | $V_{CIN(on)}$         | Applied between  | 0    | —    | 0.8   | Volts |
| Input OFF Voltage                      | $V_{CIN(off)}$        | $U_P, V_P, W_P, U_N, V_N, W_N$ -GND                      | 4.0  | —    | 5.0   | Volts |
| Module Case Operating Temperature      | $T_C$                 |  | —    | —    | 100   | °C    |
| PWM Input Frequency                    | $f_{PWM}$             | $T_C \leq 100^\circ\text{C}, T_J \leq 125^\circ\text{C}$ | —    | —    | 15    | kHz   |
| Allowable Minimum Input On-pulse Width | $t_{XX}$              |  | 1    | —    | —     | μs    |
| Arm Shoot-through Blocking Time        | $t_{DEAD}$            | Relate to Corresponding Inputs                           | 4.0  | —    | —     | μs    |

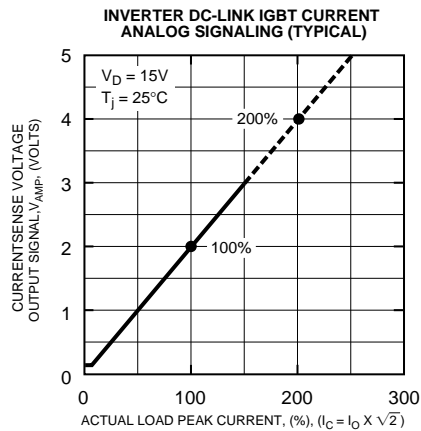

**PS12036**  
**Intellimod™ Module**  
**Application Specific IPM**  
 15 Amperes/1200 Volts

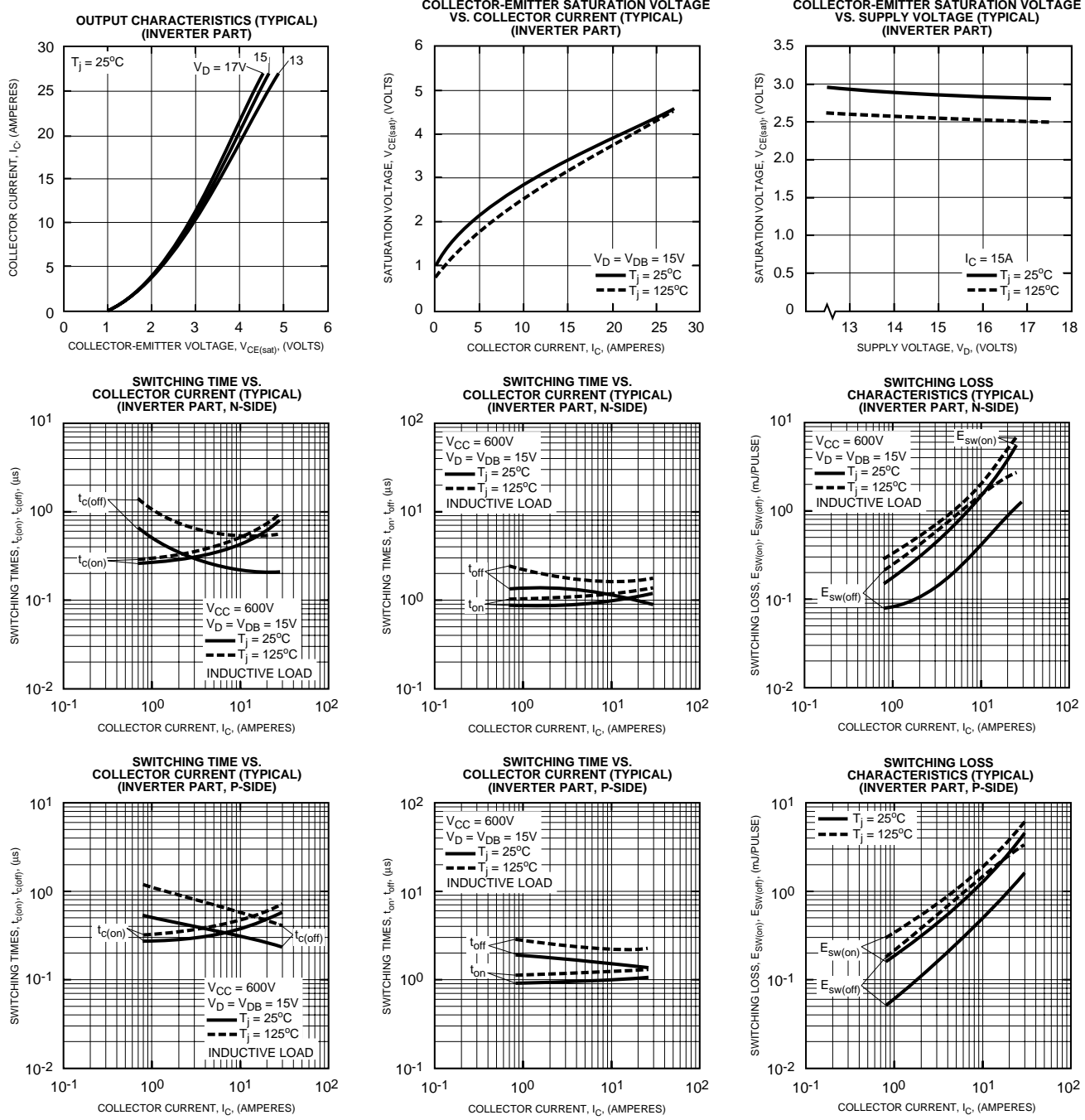

**PS12036**  
**Intellimod™ Module**  
**Application Specific IPM**  
 15 Amperes/1200 Volts

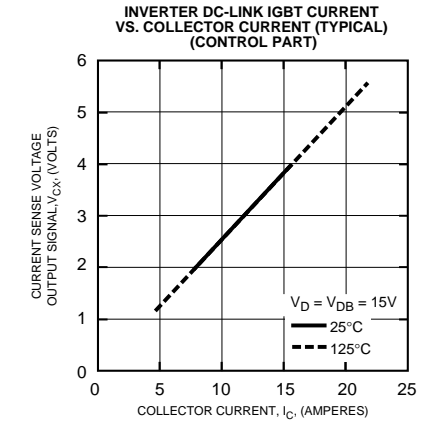
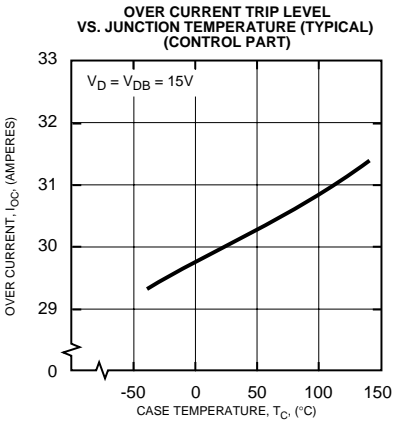
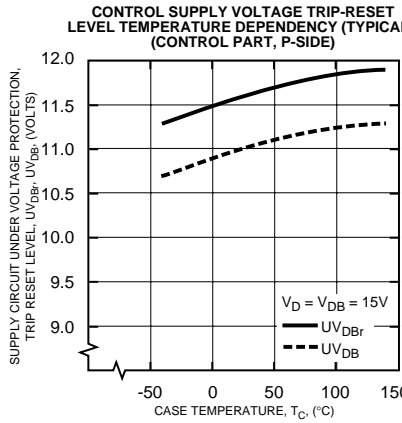
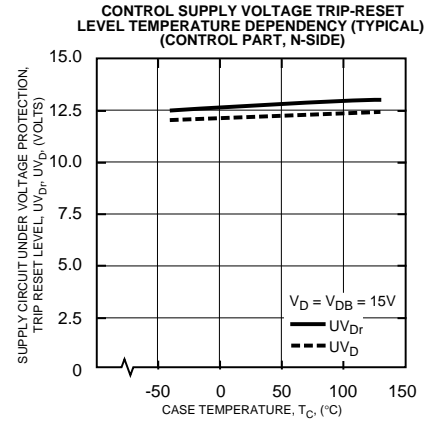
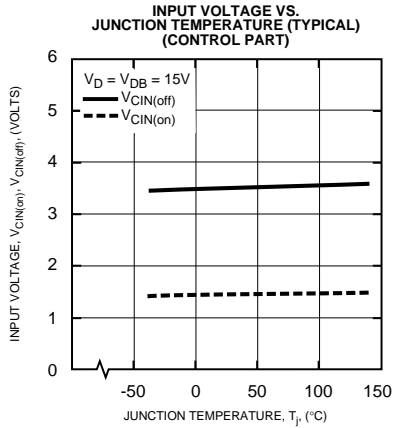
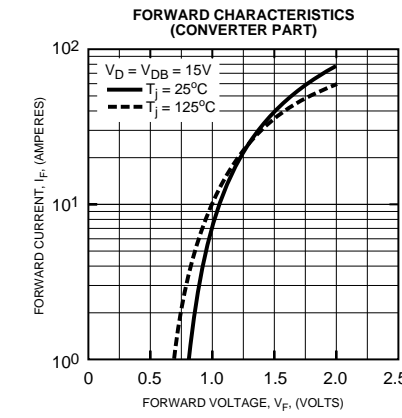
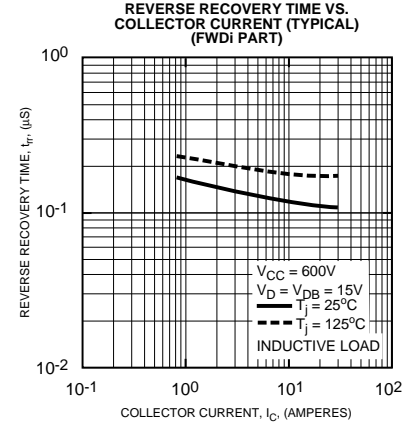
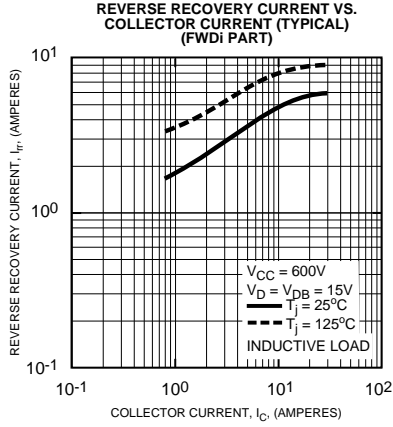
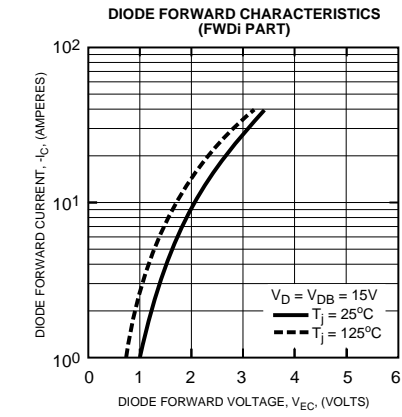

**PS12036**  
**Intellimod™ Module**  
**Application Specific IPM**  
 15 Amperes/1200 Volts

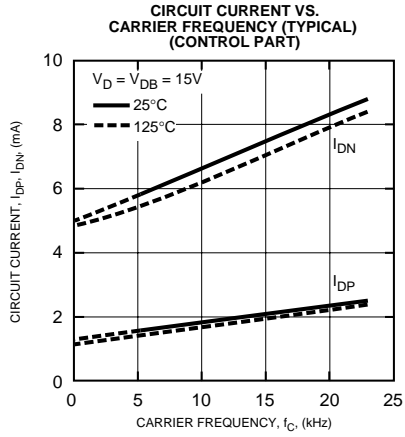

Functional Block Diagram

