

Replaced by MW6S010NR1/GNR1. There are no form, fit or function changes with this part replacement. N suffix indicates RoHS compliant part.

RF Power Field Effect Transistor

N-Channel Enhancement-Mode Lateral MOSFETs

Designed for Class A or Class AB base station applications with frequencies up to 1500 MHz. Suitable for analog and digital modulation and multicarrier amplifier applications.

- Typical Two-Tone Performance @ 960 MHz, $V_{DD} = 28$ Volts, $I_{DQ} = 125$ mA, $P_{out} = 10$ Watts PEP
 Power Gain — 18 dB
 Drain Efficiency — 32%
 IMD — -37 dBc
- Capable of Handling 10:1 VSWR, @ 28 Vdc, 960 MHz, 10 Watts CW Output Power
- Characterized with Series Equivalent Large-Signal Impedance Parameters
- On-Chip RF Feedback for Broadband Stability
- Qualified Up to a Maximum of 32 V_{DD} Operation
- Integrated ESD Protection
- 200°C Capable Plastic Package
- In Tape and Reel. R1 Suffix = 500 Units per 24 mm, 13 inch Reel.

MW6S010MR1
MW6S010GMR1

450-1500 MHz, 10 W, 28 V
LATERAL N-CHANNEL
BROADBAND RF POWER MOSFETs

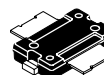

CASE 1265-08, STYLE 1
TO-270-2
PLASTIC
MW6S010MR1

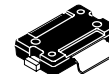

CASE 1265A-02, STYLE 1
TO-270-2 GULL
PLASTIC
MW6S010GMR1

ARCHIVE INFORMATION

ARCHIVE INFORMATION

Table 1. Maximum Ratings

Rating	Symbol	Value	Unit
Drain-Source Voltage	V_{DSS}	-0.5, +68	Vdc
Gate-Source Voltage	V_{GS}	-0.5, +12	Vdc
Total Device Dissipation @ $T_C = 25^\circ\text{C}$ Derate above 25°C	P_D	61.4 0.35	W W/°C
Storage Temperature Range	T_{stg}	-65 to +175	°C
Operating Junction Temperature	T_J	200	°C

Table 2. Thermal Characteristics

Characteristic	Symbol	Value (1,2)	Unit
Thermal Resistance, Junction to Case Case Temperature 80°C, 10 W PEP	$R_{\theta JC}$	2.85	°C/W

1. MTTF calculator available at <http://www.freescale.com/rf>. Select Tools/Software/Application Software/Calculators to access the MTTF calculators by product.
2. Refer to AN1955, *Thermal Measurement Methodology of RF Power Amplifiers*. Go to <http://www.freescale.com/rf>. Select Documentation/Application Notes - AN1955.

NOTE - CAUTION - MOS devices are susceptible to damage from electrostatic charge. Reasonable precautions in handling and packaging MOS devices should be observed.

Table 3. ESD Protection Characteristics

Test Methodology	Class
Human Body Model (per JESD22-A114)	1A
Machine Model (per EIA/JESD22-A115)	A
Charge Device Model (per JESD22-C101)	III

Table 4. Moisture Sensitivity Level

Test Methodology	Rating	Package Peak Temperature	Unit
Per JESD 22-A113, IPC/JEDEC J-STD-020	1	260	°C

Table 5. Electrical Characteristics ($T_C = 25^\circ\text{C}$ unless otherwise noted)

Characteristic	Symbol	Min	Typ	Max	Unit
----------------	--------	-----	-----	-----	------

Off Characteristics

Zero Gate Voltage Drain Leakage Current ($V_{DS} = 68\text{ Vdc}$, $V_{GS} = 0\text{ Vdc}$)	I_{DSS}	—	—	10	μAdc
Zero Gate Voltage Drain Leakage Current ($V_{DS} = 28\text{ Vdc}$, $V_{GS} = 0\text{ Vdc}$)	I_{DSS}	—	—	1	μAdc
Gate-Source Leakage Current ($V_{GS} = 5\text{ Vdc}$, $V_{DS} = 0\text{ Vdc}$)	I_{GSS}	—	—	1	μAdc

On Characteristics

Gate Threshold Voltage ($V_{DS} = 10\text{ Vdc}$, $I_D = 100\ \mu\text{Adc}$)	$V_{GS(th)}$	1.5	2.3	3	Vdc
Gate Quiescent Voltage ($V_{DS} = 28\text{ Vdc}$, $I_D = 125\text{ mAdc}$)	$V_{GS(Q)}$	—	3.1	—	Vdc
Drain-Source On-Voltage ($V_{GS} = 10\text{ Vdc}$, $I_D = 0.3\text{ Adc}$)	$V_{DS(on)}$	—	0.27	0.35	Vdc

Dynamic Characteristics

Input Capacitance ($V_{DS} = 28\text{ Vdc} \pm 30\text{ mV(rms)ac}$ @ 1 MHz, $V_{GS} = 0\text{ Vdc}$)	C_{iss}	—	23	—	pF
Output Capacitance ($V_{DS} = 28\text{ Vdc} \pm 30\text{ mV(rms)ac}$ @ 1 MHz, $V_{GS} = 0\text{ Vdc}$)	C_{oss}	—	10	—	pF
Reverse Transfer Capacitance ($V_{DS} = 28\text{ Vdc} \pm 30\text{ mV(rms)ac}$ @ 1 MHz, $V_{GS} = 0\text{ Vdc}$)	C_{rss}	—	0.32	—	pF

Functional Tests (In Freescale Test Fixture, 50 ohm system) $V_{DD} = 28\text{ Vdc}$, $I_{DQ} = 125\text{ mA}$, $P_{out} = 10\text{ W PEP}$, $f = 960\text{ MHz}$, Two-Tone Test, 100 kHz Tone Spacing

Power Gain	G_{ps}	17.5	18	20.5	dB
Drain Efficiency	η_D	31	32	—	%
Intermodulation Distortion	IMD	—	-37	-33	dBc
Input Return Loss	IRL	—	-18	-10	dB

Typical Performances (In Freescale 450 MHz Demo Board, 50 ohm system) $V_{DD} = 28\text{ Vdc}$, $I_{DQ} = 150\text{ mA}$, $P_{out} = 10\text{ W PEP}$, 420 MHz < Frequency < 470 MHz, Two-Tone Test, 100 kHz Tone Spacing

Power Gain	G_{ps}	—	20	—	dB
Drain Efficiency	η_D	—	33	—	%
Intermodulation Distortion	IMD	—	-40	—	dBc
Input Return Loss	IRL	—	-10	—	dB

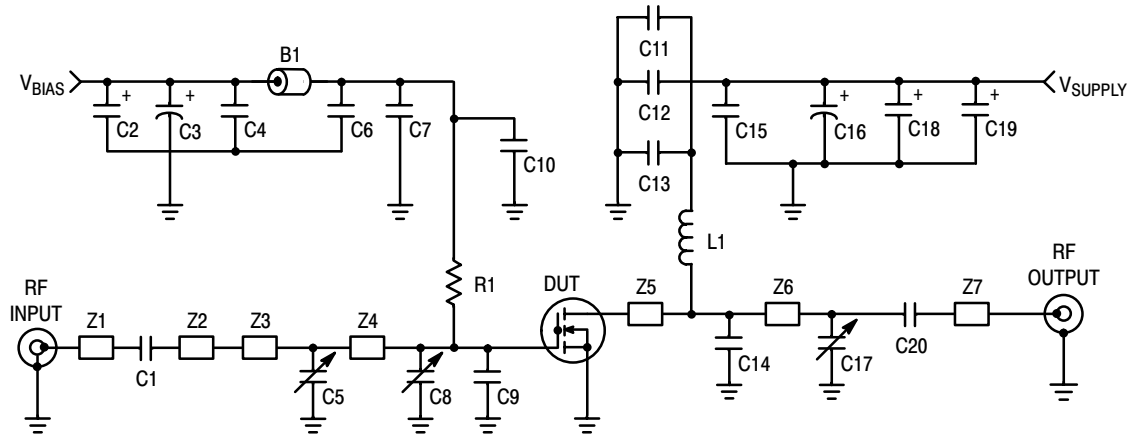

Z1	0.073" x 0.223" Microstrip	Z5	0.313" x 0.902" Microstrip
Z2	0.112" x 0.070" Microstrip	Z6	0.073" x 1.080" Microstrip
Z3	0.213" x 0.500" Microstrip	Z7	0.073" x 0.314" Microstrip
Z4	0.313" x 1.503" Microstrip	PCB	Rogers ULTRALAM 2000, 0.031", $\epsilon_r = 2.55$

Figure 1. MW6S010MR1(GMR1) Test Circuit Schematic — 900 MHz

Table 6. MW6S010MR1(GMR1) Test Circuit Component Designations and Values — 900 MHz

Part	Description	Part Number	Manufacturer
B1	Ferrite Bead	2743019447	Fair-Rite
C1, C6, C11, C20	47 pF Chip Capacitors	100B470JP500X	ATC
C2, C18, C19	22 μ F, 35 V Tantalum Capacitors	T491D226K035AS	Kemet
C3, C16	220 μ F, 63 V Electrolytic Capacitors, Radial	13668221	Phillips
C4, C15	0.1 μ F Chip Capacitors	CDR33BX104AKWS	Kemet
C5, C8, C17	0.8-8.0 pF Variable Capacitors, Gigatrim	272915L	Johanson
C7, C12	24 pF Chip Capacitors	100B240JP500X	ATC
C9, C10, C13	6.8 pF Chip Capacitors	100B6R8JP500X	ATC
C14	7.5 pF Chip Capacitor	100B7R5JP500X	ATC
L1	12.5 nH Inductor	A04T-5	Coilcraft
R1	1 k Ω Chip Resistor	CRCW12061001F100	Vishay-Dale

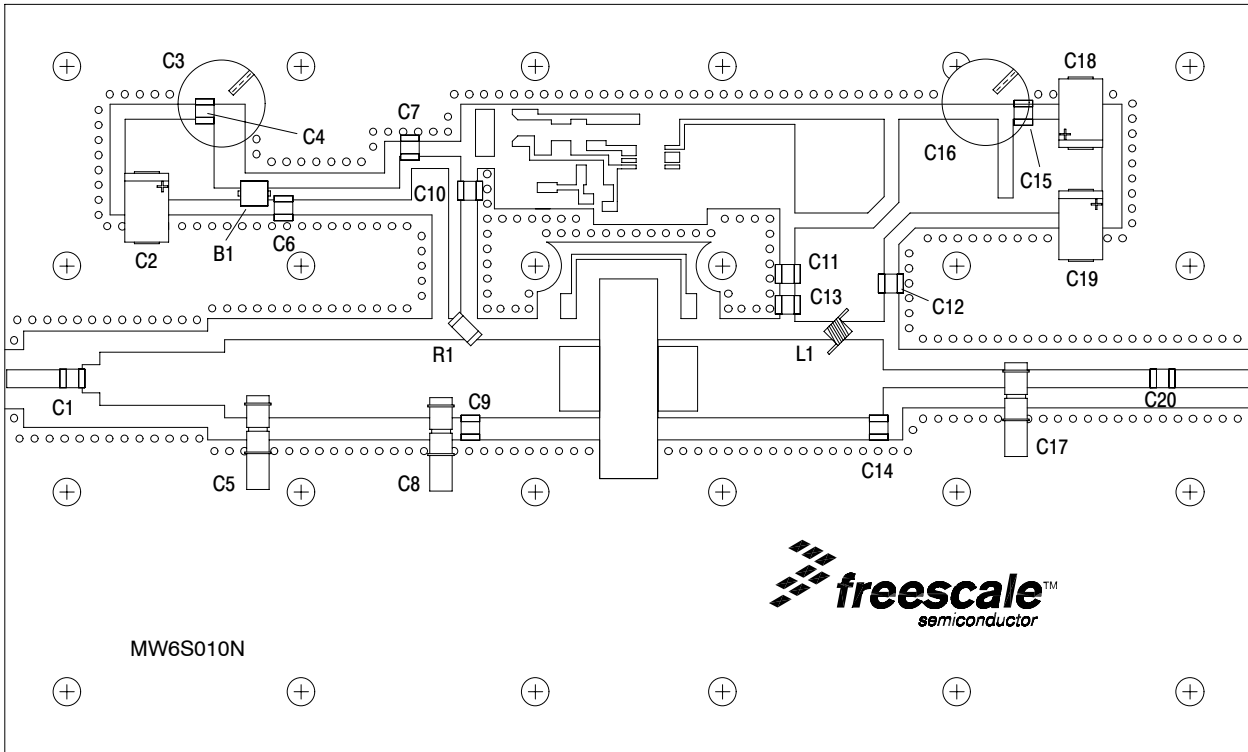

Figure 2. MW6S010MR1(GMR1) Test Circuit Component Layout — 900 MHz

TYPICAL CHARACTERISTICS — 900 MHz

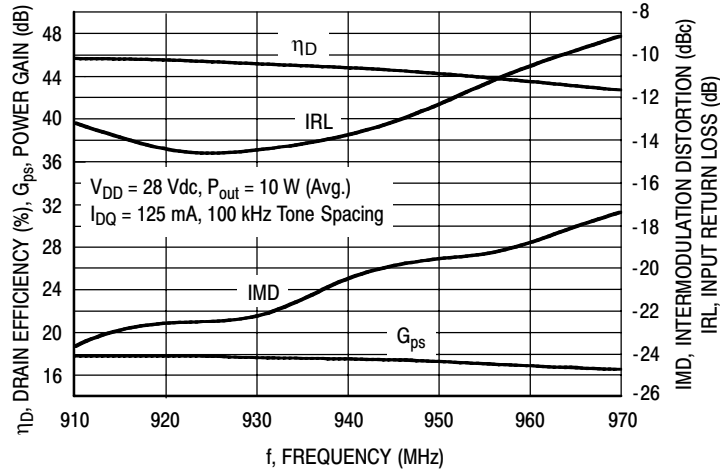

Figure 3. Two-Tone Wideband Performance @ $P_{out} = 10$ Watts

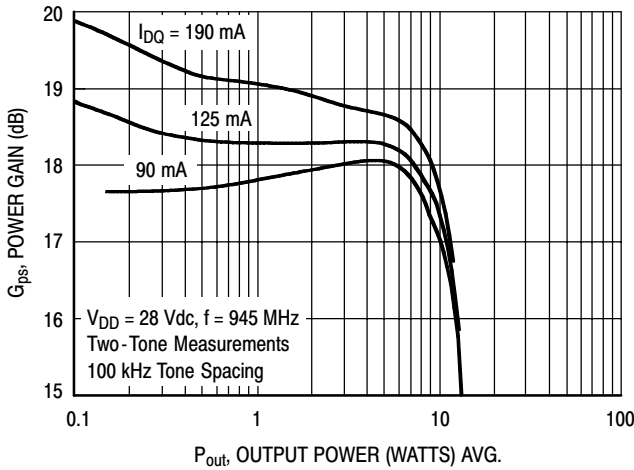

Figure 4. Two-Tone Power Gain versus Output Power

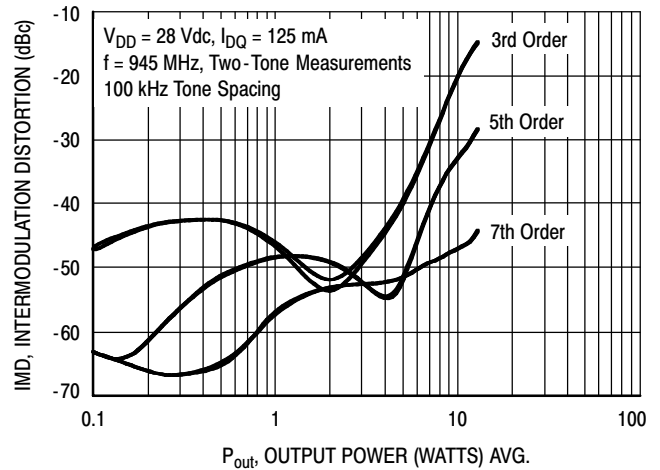

Figure 5. Intermodulation Distortion Products versus Output Power

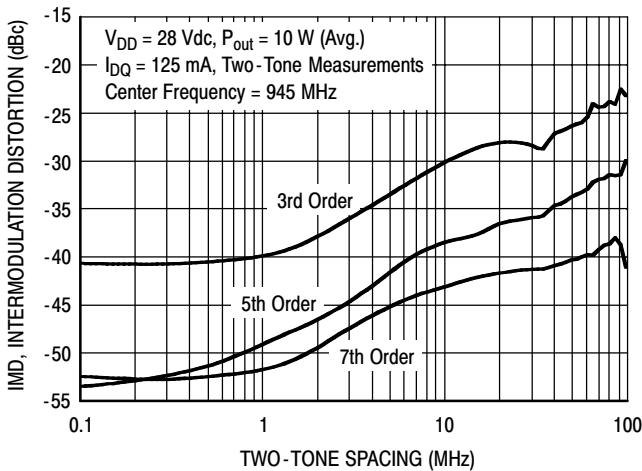

Figure 6. Intermodulation Distortion Products versus Tone Spacing

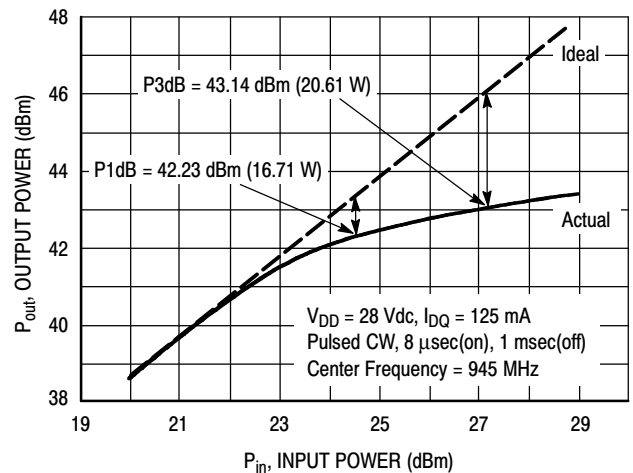

Figure 7. Pulse CW Output Power versus Input Power

ARCHIVE INFORMATION

ARCHIVE INFORMATION

TYPICAL CHARACTERISTICS — 900 MHz

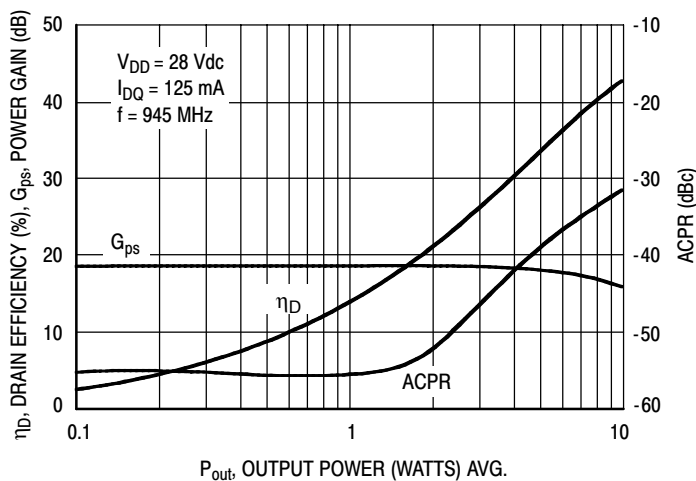

Figure 8. Single-Carrier CDMA ACPR, Power Gain and Power Added Efficiency versus Output Power

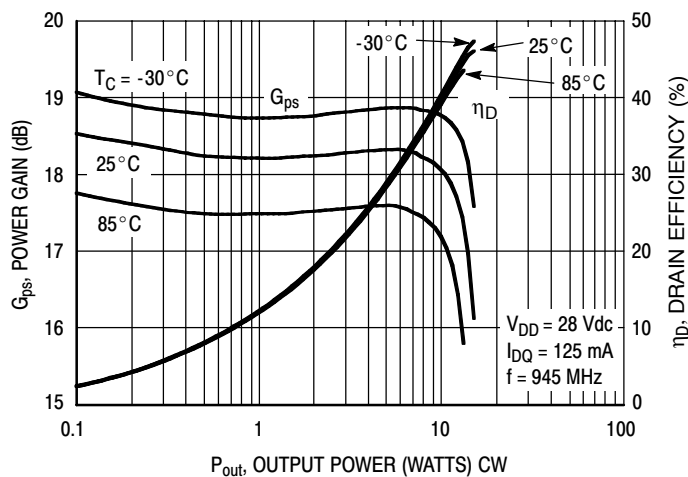

Figure 9. Power Gain and Power Added Efficiency versus Output Power

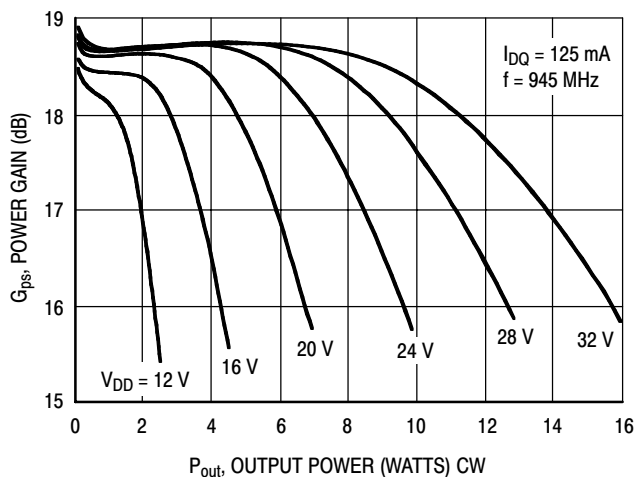

Figure 10. Power Gain versus Output Power

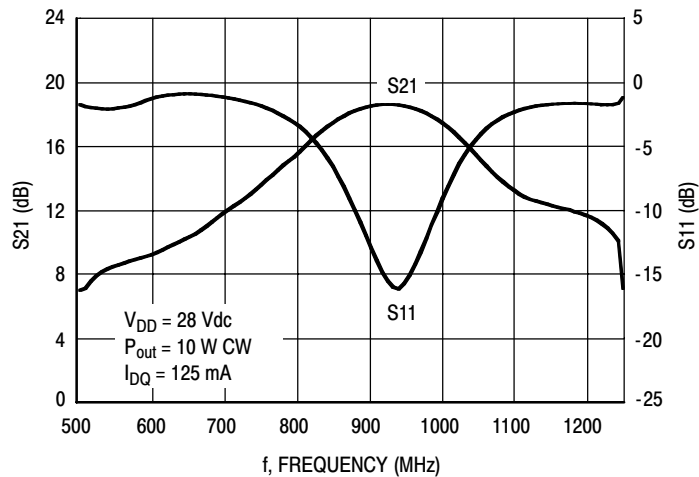
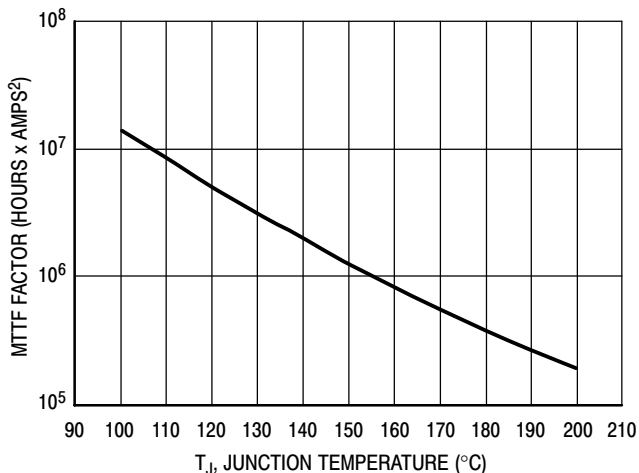

Figure 11. Broadband Frequency Response

TYPICAL CHARACTERISTICS



This above graph displays calculated MTTF in hours x ampere² drain current. Life tests at elevated temperatures have correlated to better than ±10% of the theoretical prediction for metal failure. Divide MTTF factor by I_D^2 for MTTF in a particular application.

Figure 12. MTTF Factor versus Junction Temperature

ARCHIVE INFORMATION

ARCHIVE INFORMATION

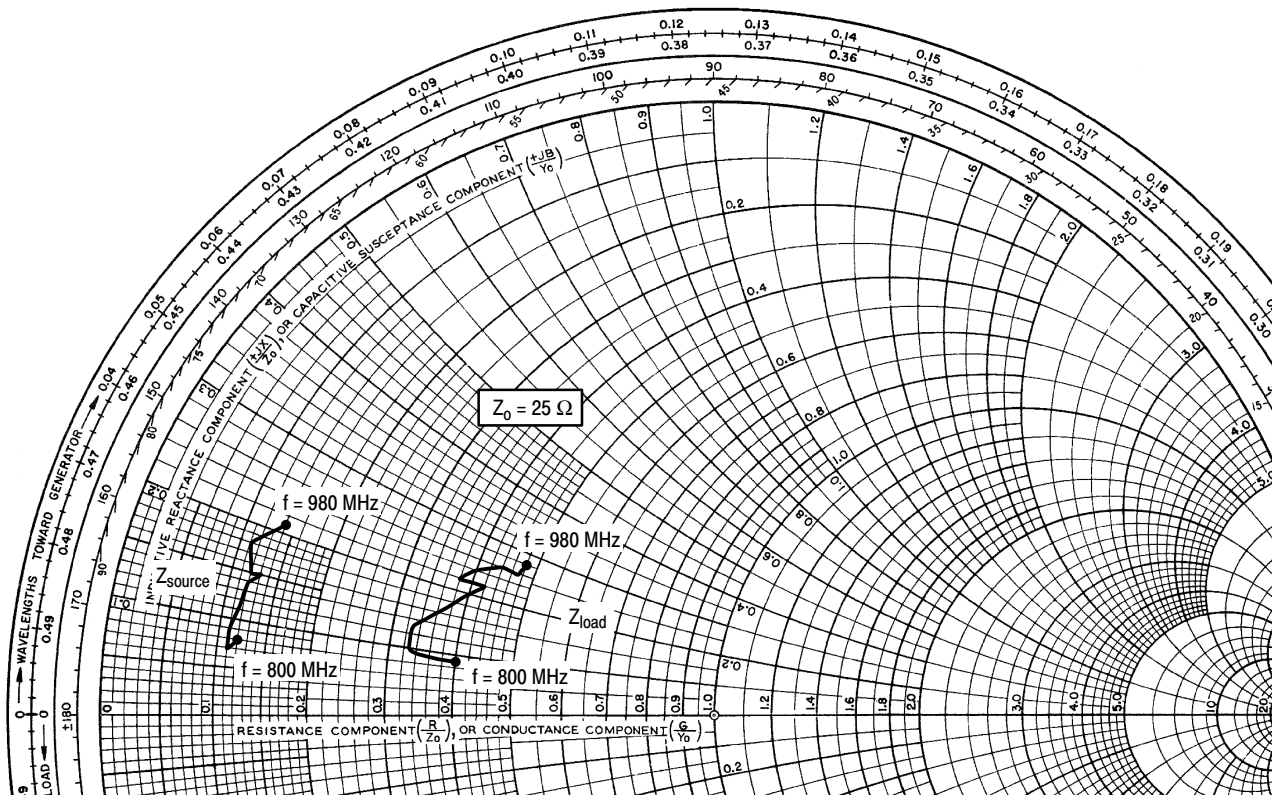

$V_{DD} = 28 \text{ Vdc}$, $I_{DQ} = 125 \text{ mA}$, $P_{out} = 10 \text{ W PEP}$

f MHz	Z_{source} Ω	Z_{load} Ω
800	$3.1 + j1.9$	$10.1 + j2.3$
820	$2.8 + j1.7$	$8.3 + j2.5$
840	$2.7 + j2.2$	$8.2 + j3.3$
860	$3.1 + j3.4$	$9.8 + j4.8$
880	$3.3 + j3.8$	$10.6 + j5.6$
900	$2.9 + j3.7$	$9.5 + j5.5$
920	$2.8 + j4.4$	$10.1 + j5.9$
940	$3.0 + j4.7$	$11.0 + j6.4$
960	$3.2 + j4.9$	$11.8 + j6.6$
980	$3.6 + j5.2$	$12.1 + j7.1$

Z_{source} = Test circuit impedance as measured from gate to ground.

Z_{load} = Test circuit impedance as measured from drain to ground.

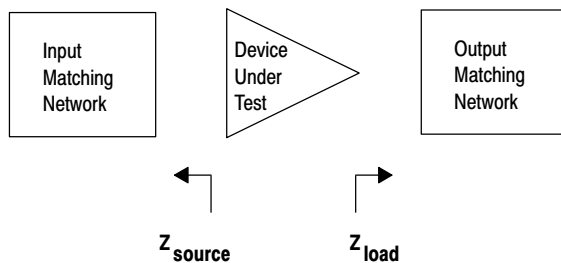
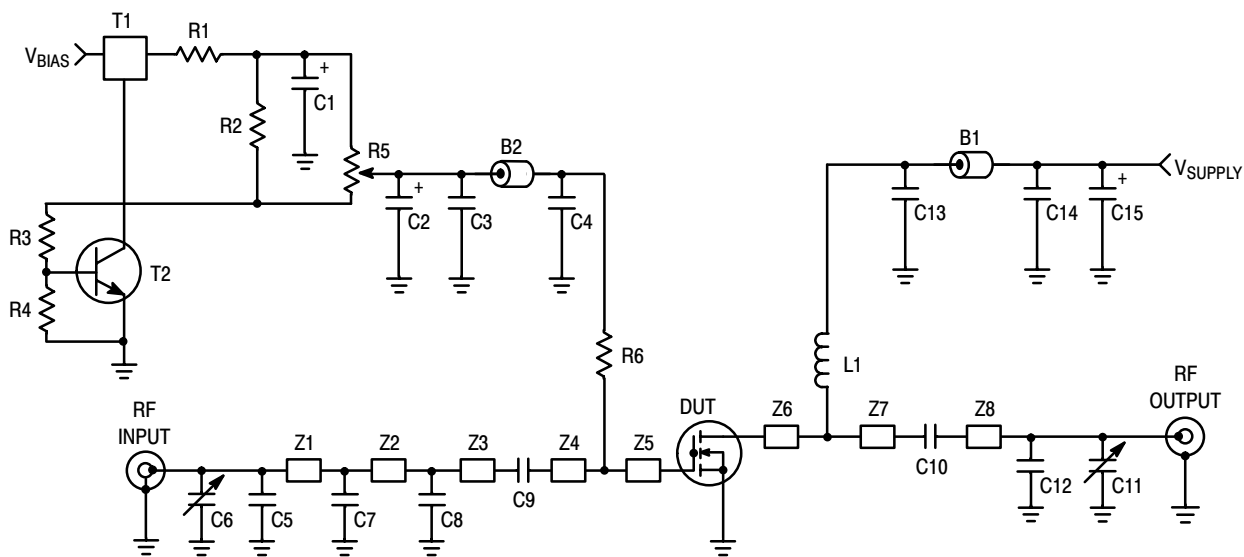

Figure 13. Series Equivalent Source and Load Impedance — 900 MHz



Z1	0.540" x 0.080" Microstrip	Z5	0.475" x 0.330" Microstrip
Z2	0.365" x 0.080" Microstrip	Z6	0.475" x 0.325" Microstrip
Z3	0.225" x 0.080" Microstrip	Z8	1.250" x 0.080" Microstrip
Z4, Z7	0.440" x 0.080" Microstrip	PCB	Rogers ULTRALAM 2000, 0.030", $\epsilon_r = 2.55$

Figure 14. MW6S010MR1(GMR1) Test Circuit Schematic — 450 MHz

Table 7. MW6S010MR1(GMR1) Test Circuit Component Designations and Values — 450 MHz

Part	Description	Part Number	Manufacturer
B1, B2	Ferrite Bead	2743019447	Fair-Rite
C1	1 μ F, 35 V Tantalum Capacitor	T491C105K050AS	Kemet
C2, C15	22 μ F, 35 V Tantalum Capacitors	T491X226K035AS	Kemet
C3, C14	0.1 μ F Chip Capacitors	C1210C104K5RACTR	Kemet
C4, C9, C10, C13	330 pF Chip Capacitors	700A331JP150X	ATC
C5	4.3 pF Chip Capacitor	100B4R3JP500X	ATC
C6, C11	0.6-8.0 pF Variable Capacitors	27291SL	Johanson
C7, C8, C12	4.7 pF Chip Capacitors	100B4R7JP500X	ATC
L1	39 μ H Chip Inductor	ISC-1210	Vishay-Dale
R1	10 Ω Chip Resistor (0805)	CRCW080510R0F100	Vishay-Dale
R2	1 k Ω Chip Resistor (0805)	CRCW08051001F100	Vishay-Dale
R3	1.2 k Ω Chip Resistor (0805)	CRCW08051201F100	Vishay-Dale
R4	2.2 k Ω Chip Resistor (0805)	CRCW08052201F100	Vishay-Dale
R5	5 k Ω Potentiometer	1224W	Bourns
R6	1 k Ω Chip Resistor (1206)	CRCW12061001F100	Vishay-Dale
T1	5 Volt Regulator, Micro 8	LP2951	On Semiconductor
T2	NPN Transistor	BC847ALT1	On Semiconductor

ARCHIVE INFORMATION

ARCHIVE INFORMATION

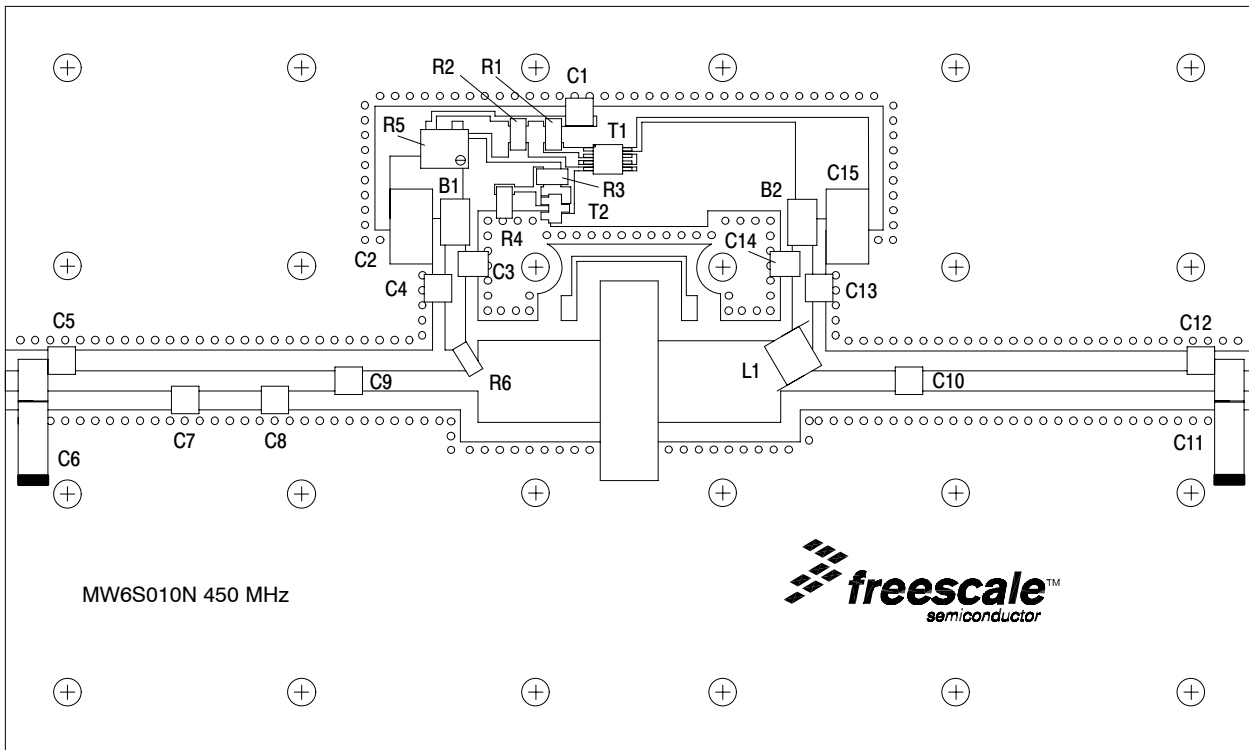

Figure 15. MW6S010MR1(GMR1) Test Circuit Component Layout — 450 MHz

TYPICAL CHARACTERISTICS — 450 MHz

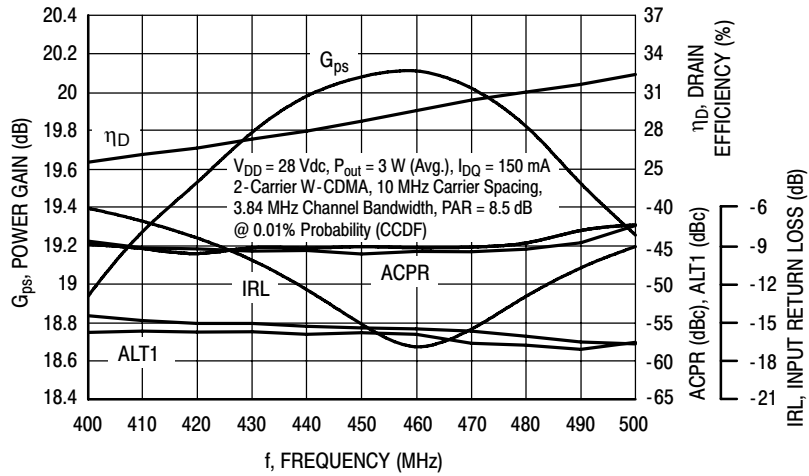

Figure 16. 2-Carrier W-CDMA Broadband Performance @ $P_{out} = 3$ Watts Avg.

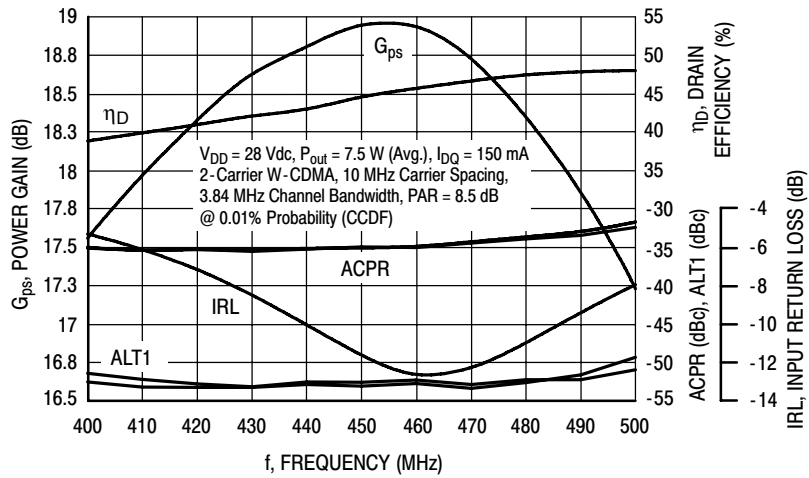

Figure 17. 2-Carrier W-CDMA Broadband Performance @ $P_{out} = 7.5$ Watts Avg.

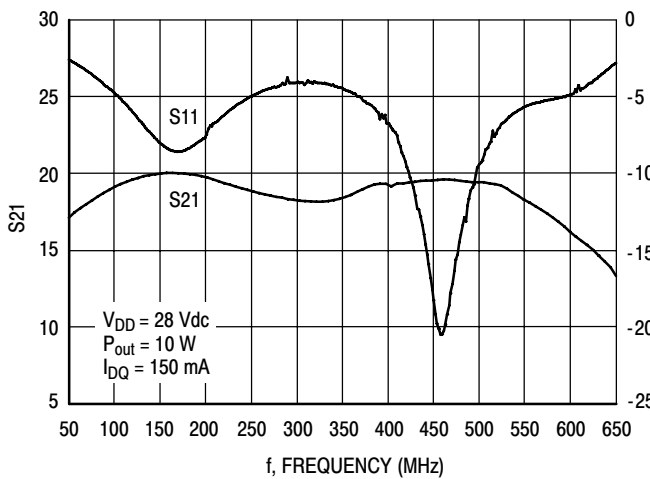

Figure 18. Broadband Frequency Response

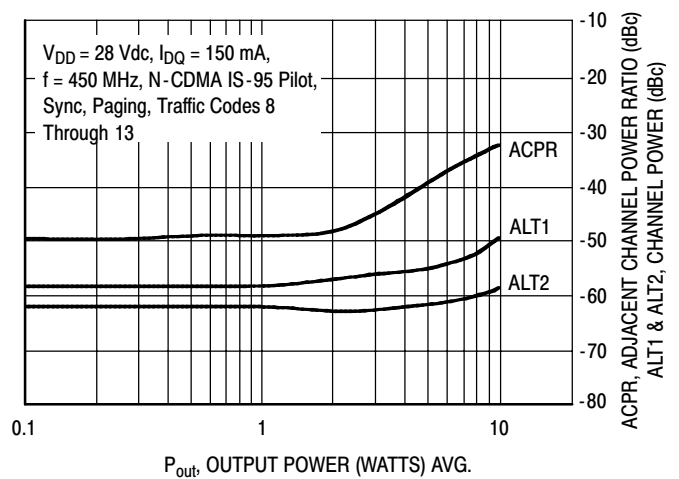
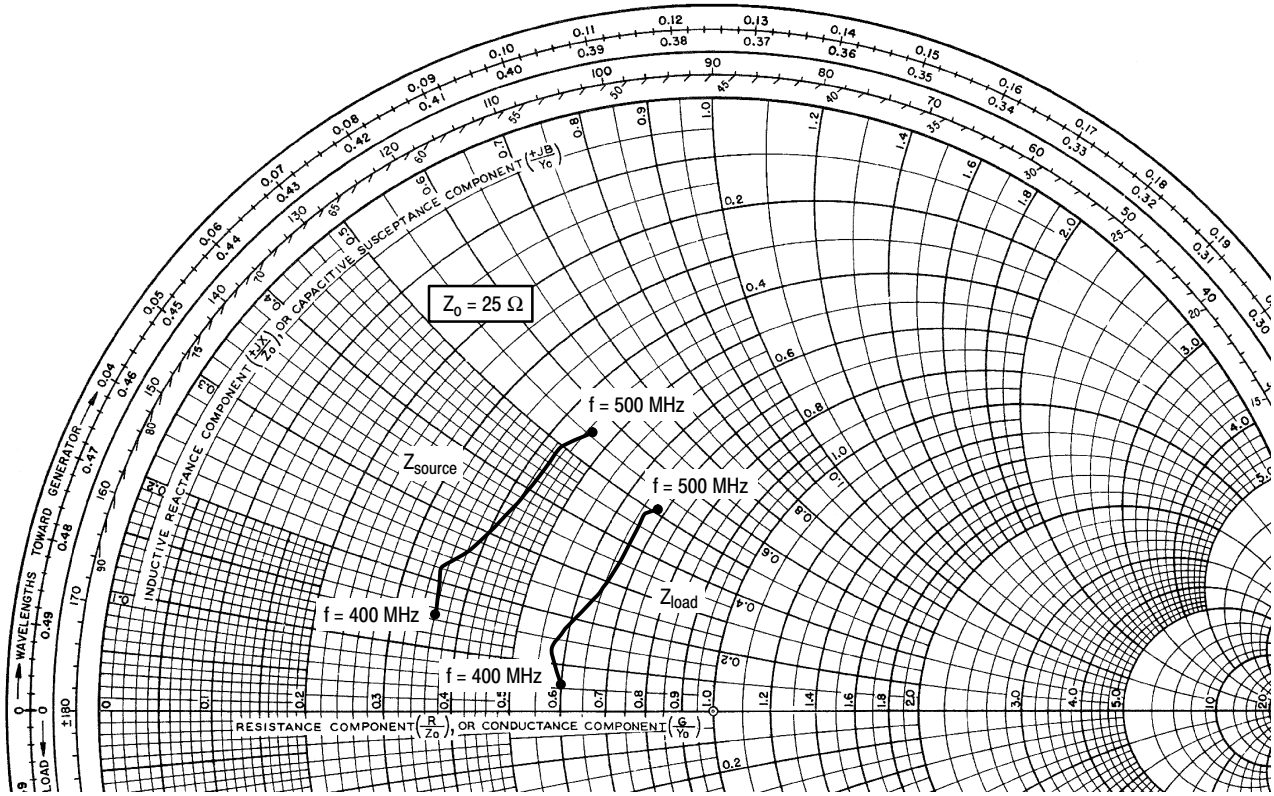

Figure 19. Single-Carrier N-CDMA ACPR, ALT1 and ALT2 versus Output Power

ARCHIVE INFORMATION

ARCHIVE INFORMATION



$V_{DD} = 28 \text{ Vdc}$, $I_{DQ} = 150 \text{ mA}$, $P_{out} = 10 \text{ W PEP}$

f MHz	Z_{source} Ω	Z_{load} Ω
400	$9.0 + j3.8$	$15.0 + j1.4$
420	$8.8 + j5.4$	$14.3 + j3.3$
440	$9.6 + j6.6$	$15.0 + j4.7$
460	$10.6 + j9.5$	$16.3 + j7.3$
480	$10.7 + j12.6$	$16.4 + j11.1$
500	$11.5 + j13.9$	$16.9 + j12.7$

Z_{source} = Test circuit impedance as measured from gate to ground.

Z_{load} = Test circuit impedance as measured from drain to ground.

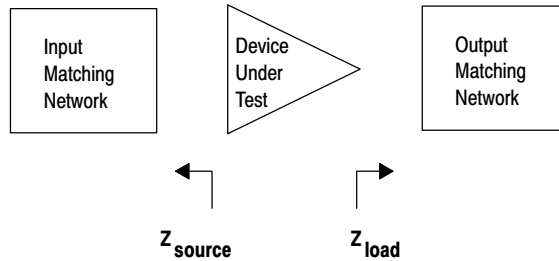

Figure 20. Series Equivalent Source and Load Impedance — 450 MHz

NOTES

NOTES

NOTES

PACKAGE DIMENSIONS

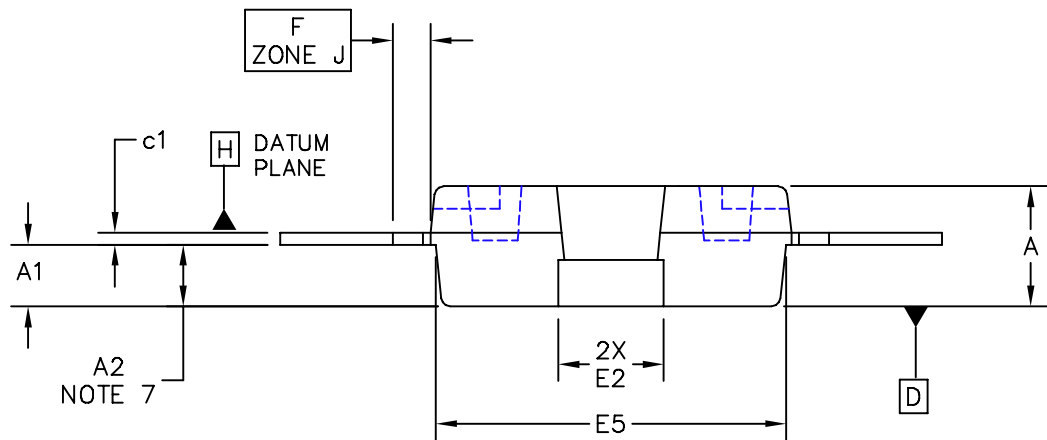
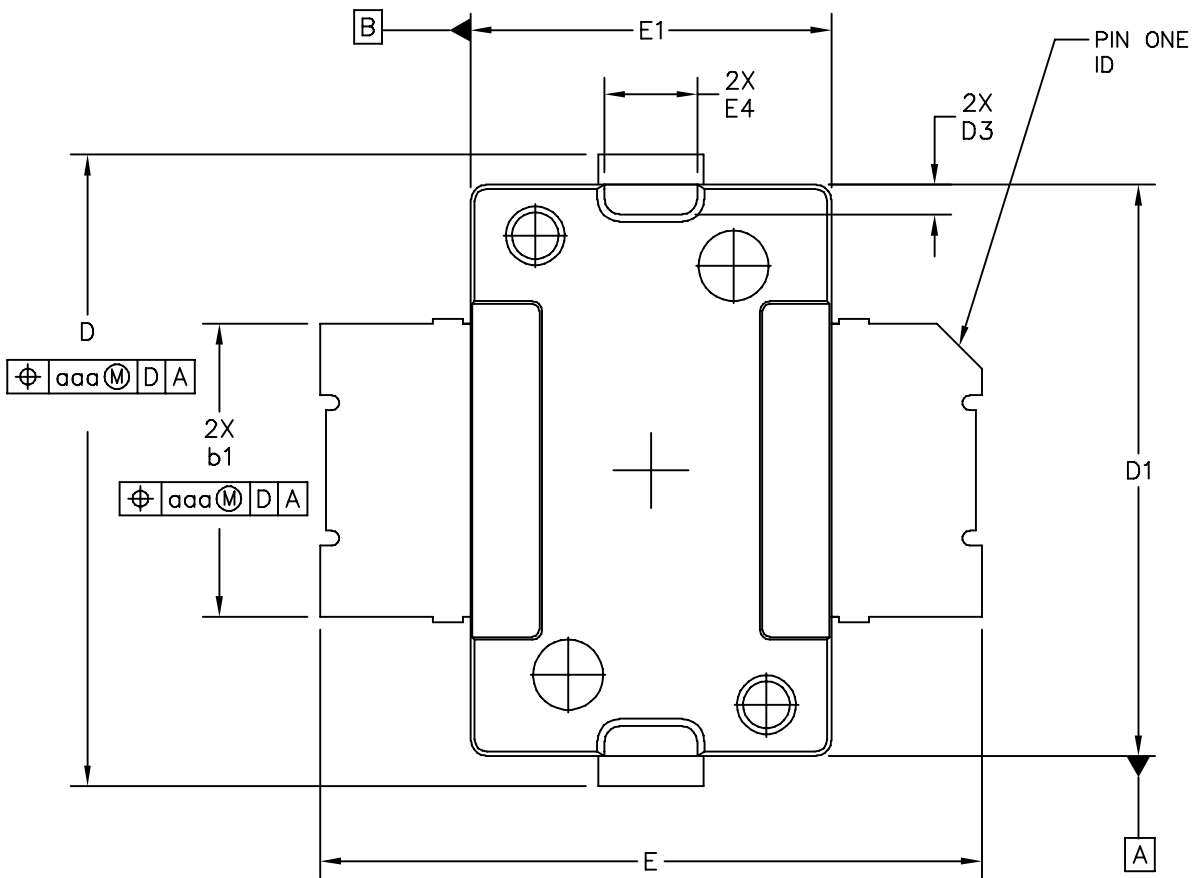

© FREESCALE SEMICONDUCTOR, INC. ALL RIGHTS RESERVED.	MECHANICAL OUTLINE	PRINT VERSION NOT TO SCALE	
TITLE: <div style="text-align: center; padding: 10px;"> TO-270 SURFACE MOUNT </div>	DOCUMENT NO: 98ASH98117A	REV: J	
	CASE NUMBER: 1265-08	01 APR 2005	
	STANDARD: NON-JEDEC		

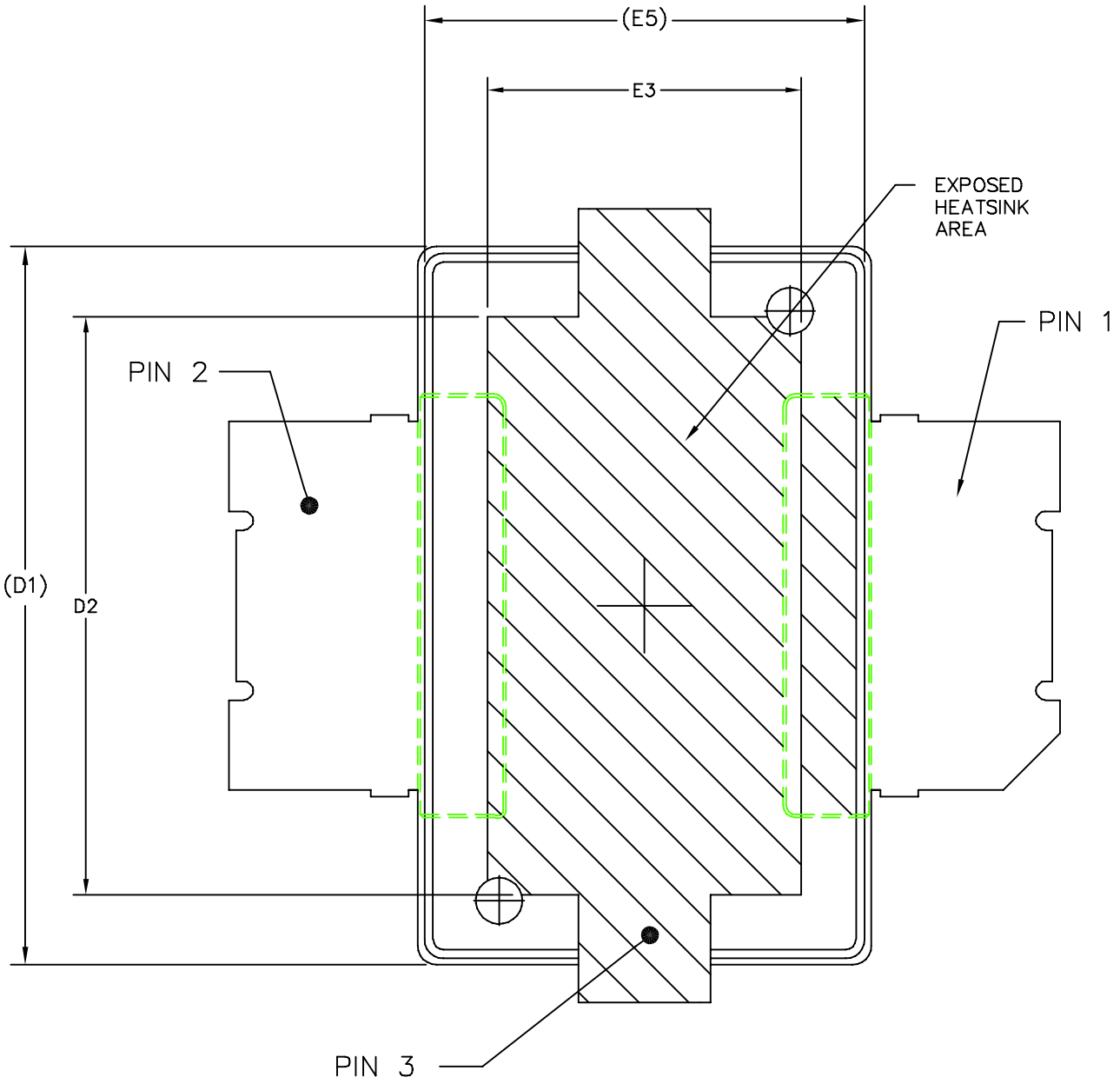

BOTTOM VIEW

© FREESCALE SEMICONDUCTOR, INC. ALL RIGHTS RESERVED.	MECHANICAL OUTLINE	PRINT VERSION NOT TO SCALE	
TITLE: TO-270 SURFACE MOUNT	DOCUMENT NO: 98ASH98117A	REV: J	
	CASE NUMBER: 1265-08	01 APR 2005	
	STANDARD: NON-JEDEC		

NOTES:

1. CONTROLLING DIMENSION: INCH
2. INTERPRET DIMENSIONS AND TOLERANCES PER ASME Y14.5M-1994.
3. DATUM PLANE -H- IS LOCATED AT TOP OF LEAD AND IS COINCIDENT WITH THE LEAD WHERE THE LEAD EXITS THE PLASTIC BODY AT THE TOP OF THE PARTING LINE.
4. DIMENSIONS "D1" AND "E1" DO NOT INCLUDE MOLD PROTRUSION. ALLOWABLE PROTRUSION IS .006 PER SIDE. DIMENSIONS "D1 AND "E1" DO INCLUDE MOLD MISMATCH AND ARE DETERMINED AT DATUM PLANE -H-.
5. DIMENSION "b1" DOES NOT INCLUDE DAMBAR PROTRUSION. ALLOWABLE DAMBAR PROTRUSION SHALL BE .005 TOTAL IN EXCESS OF THE "b1" DIMENSION AT MAXIMUM MATERIAL CONDITION.
6. DATUMS -A- AND -B- TO BE DETERMINED AT DATUM PLANE -H-.
7. DIMENSION "A2" APPLIES WITHIN ZONE "J" ONLY.
8. DIMENSIONS "D" AND "E2" DO NOT INCLUDE MOLD PROTRUSION. OVERALL LENGTH INCLUDING MOLD PROTRUSION SHOULD NOT EXCEED 0.430 INCH FOR DIMENSION "D" AND 0.080 INCH FOR DIMENSION "E2". DIMENSIONS "D" AND "E2" DO INCLUDE MOLD MISMATCH AND ARE DETERMINED AT DATUM PLANE -D-.

STYLE 1:
 PIN 1 - DRAIN
 PIN 2 - GATE
 PIN 3 - SOURCE

DIM	INCH		MILLIMETER		DIM	INCH		MILLIMETER	
	MIN	MAX	MIN	MAX		MIN	MAX	MIN	MAX
A	.078	.082	1.98	2.08	F	.025 BSC		0.64 BSC	
A1	.039	.043	0.99	1.09	b1	.193	.199	4.90	5.06
A2	.040	.042	1.02	1.07	c1	.007	.011	0.18	0.28
D	.416	.424	10.57	10.77	aaa	.004		0.10	
D1	.378	.382	9.60	9.70					
D2	.290	.320	7.37	8.13					
D3	.016	.024	0.41	0.61					
E	.436	.444	11.07	11.28					
E1	.238	.242	6.04	6.15					
E2	.066	.074	1.68	1.88					
E3	.150	.180	3.81	4.57					
E4	.058	.066	1.47	1.68					
E5	.231	.235	5.87	5.97					
© FREESCALE SEMICONDUCTOR, INC. ALL RIGHTS RESERVED.			MECHANICAL OUTLINE			PRINT VERSION NOT TO SCALE			
TITLE: TO-270 SURFACE MOUNT					DOCUMENT NO: 98ASH98117A			REV: J	
					CASE NUMBER: 1265-08			01 APR 2005	
					STANDARD: NON-JEDEC				

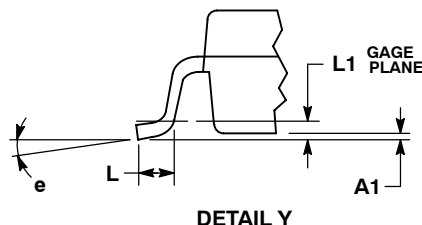
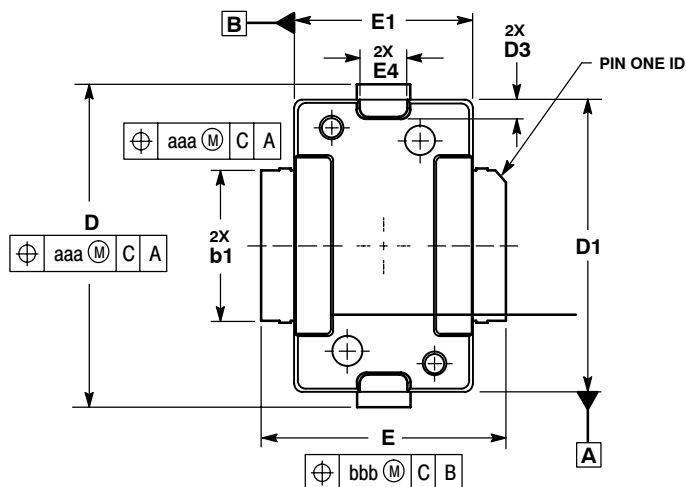

- NOTES:
1. CONTROLLING DIMENSION: INCH.
 2. INTERPRET DIMENSIONS AND TOLERANCES PER ASME Y14.5M-1994.
 3. DATUM PLANE -H- IS LOCATED AT TOP OF LEAD AND IS COINCIDENT WITH THE LEAD WHERE THE LEAD EXITS THE PLASTIC BODY AT THE TOP OF THE PARTING LINE.
 4. DIMENSIONS "D1" AND "E1" DO NOT INCLUDE MOLD PROTRUSION. ALLOWABLE PROTRUSION IS .006 PER SIDE. DIMENSIONS "D1" AND "E1" DO INCLUDE MOLD MISMATCH AND ARE DETERMINED AT DATUM PLANE -H-.
 5. DIMENSION b1 DOES NOT INCLUDE DAMBAR PROTRUSION. ALLOWABLE DAMBAR PROTRUSION SHALL BE .005 TOTAL IN EXCESS OF THE b1 DIMENSION AT MAXIMUM MATERIAL CONDITION.
 6. DATUMS -A- AND -B- TO BE DETERMINED AT DATUM PLANE -H-.
 7. DIMENSIONS "D" AND "E2" DO NOT INCLUDE MOLD PROTRUSION. ALLOWABLE PROTRUSION IS .003 PER SIDE. DIMENSIONS "D" AND "E2" DO INCLUDE MOLD MISMATCH AND ARE DETERMINED AT DATUM PLANE -D-.

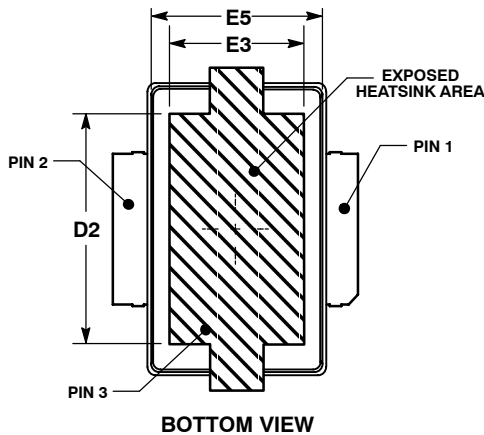
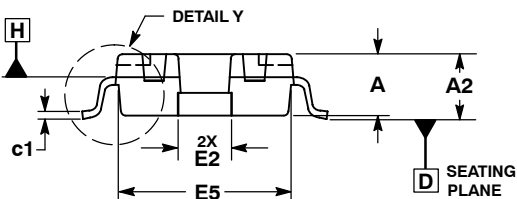

DIM	INCHES		MILLIMETERS	
	MIN	MAX	MIN	MAX
A	.078	.082	1.98	2.08
A1	.001	.004	0.02	0.10
A2	.077	.088	1.96	2.24
D	.416	.424	10.57	10.77
D1	.378	.382	9.60	9.70
D2	.290	.320	7.37	8.13
D3	.016	.024	0.41	0.61
E	.316	.324	8.03	8.23
E1	.238	.242	6.04	6.15
E2	.066	.074	1.68	1.88
E3	.150	.180	3.81	4.57
E4	.058	.066	1.47	1.68
E5	.231	.235	5.87	5.97
L	.018	.024	4.90	5.06
L1	.01 BSC		0.25 BSC	
b1	.193	.199	4.90	5.06
c1	.007	.011	0.18	0.28
e	2°		8°	
aaa	.004		0.10	

STYLE 1:
 PIN 1. DRAIN
 2. GATE
 3. SOURCE

**CASE 1265A-02
 ISSUE B
 TO-270-2 GULL
 PLASTIC
 MW6S010GMR1**

How to Reach Us:

Home Page:

www.freescale.com

E-mail:

support@freescale.com

USA/Europe or Locations Not Listed:

Freescale Semiconductor
Technical Information Center, CH370
1300 N. Alma School Road
Chandler, Arizona 85224
+1-800-521-6274 or +1-480-768-2130
support@freescale.com

Europe, Middle East, and Africa:

Freescale Halbleiter Deutschland GmbH
Technical Information Center
Schatzbogen 7
81829 Muenchen, Germany
+44 1296 380 456 (English)
+46 8 52200080 (English)
+49 89 92103 559 (German)
+33 1 69 35 48 48 (French)
support@freescale.com

Japan:

Freescale Semiconductor Japan Ltd.
Headquarters
ARCO Tower 15F
1-8-1, Shimo-Meguro, Meguro-ku,
Tokyo 153-0064
Japan
0120 191014 or +81 3 5437 9125
support.japan@freescale.com

Asia/Pacific:

Freescale Semiconductor Hong Kong Ltd.
Technical Information Center
2 Dai King Street
Tai Po Industrial Estate
Tai Po, N.T., Hong Kong
+800 2666 8080
support.asia@freescale.com

For Literature Requests Only:

Freescale Semiconductor Literature Distribution Center
P.O. Box 5405
Denver, Colorado 80217
1-800-441-2447 or 303-675-2140
Fax: 303-675-2150
LDCForFreescaleSemiconductor@hibbertgroup.com

Information in this document is provided solely to enable system and software implementers to use Freescale Semiconductor products. There are no express or implied copyright licenses granted hereunder to design or fabricate any integrated circuits or integrated circuits based on the information in this document.

Freescale Semiconductor reserves the right to make changes without further notice to any products herein. Freescale Semiconductor makes no warranty, representation or guarantee regarding the suitability of its products for any particular purpose, nor does Freescale Semiconductor assume any liability arising out of the application or use of any product or circuit, and specifically disclaims any and all liability, including without limitation consequential or incidental damages. "Typical" parameters that may be provided in Freescale Semiconductor data sheets and/or specifications can and do vary in different applications and actual performance may vary over time. All operating parameters, including "Typicals", must be validated for each customer application by customer's technical experts. Freescale Semiconductor does not convey any license under its patent rights nor the rights of others. Freescale Semiconductor products are not designed, intended, or authorized for use as components in systems intended for surgical implant into the body, or other applications intended to support or sustain life, or for any other application in which the failure of the Freescale Semiconductor product could create a situation where personal injury or death may occur. Should Buyer purchase or use Freescale Semiconductor products for any such unintended or unauthorized application, Buyer shall indemnify and hold Freescale Semiconductor and its officers, employees, subsidiaries, affiliates, and distributors harmless against all claims, costs, damages, and expenses, and reasonable attorney fees arising out of, directly or indirectly, any claim of personal injury or death associated with such unintended or unauthorized use, even if such claim alleges that Freescale Semiconductor was negligent regarding the design or manufacture of the part.

Freescale™ and the Freescale logo are trademarks of Freescale Semiconductor, Inc. All other product or service names are the property of their respective owners.
© Freescale Semiconductor, Inc. 2006. All rights reserved.

RoHS-compliant and/or Pb-free versions of Freescale products have the functionality and electrical characteristics of their non-RoHS-compliant and/or non-Pb-free counterparts. For further information, see <http://www.freescale.com> or contact your Freescale sales representative.

For information on Freescale's Environmental Products program, go to <http://www.freescale.com/epp>.

