

ISL8240MEVAL3Z 40A, Single Output Evaluation Board Setup Procedure

Description

The [ISL8240M](#) is a complete, dual step-down switching mode DC/DC module. The dual outputs can easily be paralleled for single-output, high-current use. It is easy to apply this high-power, current-sharing DC/DC power module to power-hungry datacom, telecom, and FPGA applications. All that is needed in order to have a complete, 40A design ready for use are the ISL8240M, a few passive components, and V_{OUT} setting resistors.

The ease of use virtually eliminates design and manufacturing risks while dramatically improving time to market.

The simplicity of the ISL8240M is its off-the-shelf, unassisted implementation. Patented module structure allows for higher power density and better efficiency than competing solutions. Patented current sharing in multi-phase operation greatly reduces ripple currents, BOM costs, and complexity.

The ISL8240MEVAL3Z evaluation board enables a single output by paralleling two phases to deliver 40A continuous load current. To evaluate the dual output configuration of the ISL8240M, please refer to application note [AN1922](#), "ISL8240MEVAL4Z Dual 20A/Optional 40A Cascadable Evaluation Board Setup Procedure." The ISL8240M supports input voltage from 4.5V to 20V and the output voltage ranges from 0.6V to 2.5V. With the single resistor modification, the output voltage can be easily adjusted to different voltages.

Related Resources

- [ISL8240M](#) datasheet.

Board Features

- Small, compact, and simple design
- Connectors, test points, and jumpers for easy probing

Specifications

This evaluation board is designed to operate at the following operating conditions:

- Input voltage range from 4.5V to 20V
- Resistor programmable output voltage range from 0.6V to 2.5V (default 1.0V)
- 20A output current if V_{OUT} is below 1.5V (output current may need to be derated for certain conditions if V_{OUT} is 1.5V or above 1.5V)
- Switching frequency range from 350kHz to 700kHz (500kHz by default)
- Operating temperature range: -40°C to $+85^{\circ}\text{C}$

Recommended Equipment

- 0V to 20V power supply with at least 10A source current capability
- Electronic load capable of sinking current up to 40A
- Digital Multimeters (DMMs)
- 100MHz quad-trace oscilloscope

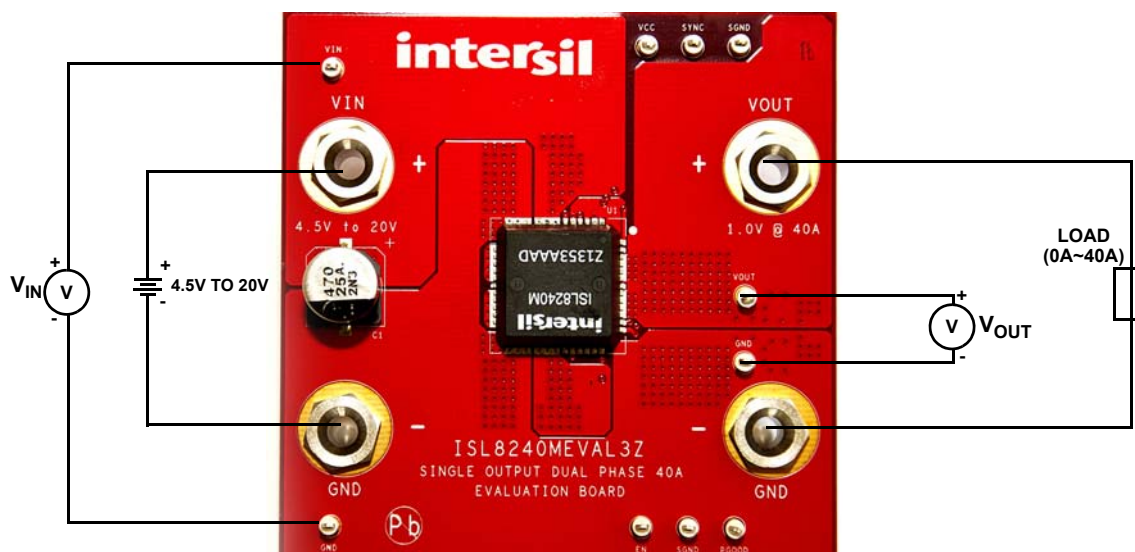

FIGURE 1. ISL8240MEVAL3Z BOARD IMAGE

Quick Start

The inputs are J1 (VIN) and J2 (GND). The outputs are J3 (VOUT) and J4 (GND). Refer to [Figure 1](#) for connections.

1. Connect a power supply capable of sourcing at least 10A to the input J1 (VIN) and J2 (GND) of the ISL8240MEVAL3Z evaluation board, with a voltage between 4.5V to 20V. Connect an electronic load or the device to be powered to the output J3 (VOUT) and J4 (GND) of the board. All connections, especially the low voltage, high current V_{OUT} lines, should be able to carry the desired load current and should be made as short as possible.
2. Turn on the power supply. Measure the output voltage, V_{OUT} , which should be at 1.0V if the board is working properly.
3. The ISL8240MEVAL3Z is manufactured with a default V_{OUT} value of 1.0V; if different output voltages are desired, board resistors can be changed to provide the desired V_{OUT} . Please refer to the table printed on the backside of the evaluation board or [Table 1](#) for R_{VSET} resistor values, which can be used to produce different output voltages

The switching frequency is set to 500kHz by default. For V_{OUT} higher than 1.0V, the switching frequency will need to be adjusted as shown in [Table 1](#). If the output voltage is set to 1.5V or higher than 1.5V, the output current will need to be derated to allow for safe operation at elevated ambient temperatures. Please refer to the derating curves in the [ISL8240M](#) datasheet.

For $V_{IN} < 5.5V$, please tie VIN directly to VCC for best efficiency. Also, it is preferred that the EN/FF voltage be higher than 1.5V in order to achieve better stability.

TABLE 1. RESISTANCE SETTING FOR DIFFERENT OUTPUT VOLTAGES AND OPERATING FREQUENCY ($R_3 = 1k$)

V_{OUT} (V)	R_{VSET} (Ω)	FREQUENCY (kHz)	R_{FSET} (k Ω)
1.0	Default (1500)	Default (500)	Default (237)
1.2	1000	550	174
1.5	665	600	140
1.8	499	650	115
2.5	316	700	100

Evaluation Board Information

The evaluation board size is 3 inchx3 inch. It is a 6-layer board, containing 2-ounce copper on the top and bottom layers and 1-ounce copper on all internal layers. The board can be used as a 40A reference design, refer to ["Layout" on page 4](#). The board is made up of FR4 material and all components, including the solder attachment, are lead-free.

Thermal Considerations and Current Derating

For high current applications, board layout is very critical in order to make the module operate safely and deliver maximum allowable power. To carry large currents, the board layout needs to be carefully designed to maximize thermal performance. To achieve this, select enough trace width, copper weight and the proper connectors.

This evaluation board is designed for running 40A, 1.0V at room temperature without additional cooling systems needed. However, if the output voltage is increased or the board is operated at elevated temperatures, then the available current needs to be derated. Refer to the current derating curves in the [ISL8240M](#) datasheet to determine the output current available.

For layout of designs using the ISL8240M, the thermal performance can be improved by adhering to the following design tips:

1. Use the top and bottom layers to carry the large current. VOUT1, VOUT2, Phase 1, Phase 2, PGND, VIN1 and VIN2 should have large, solid planes. Place enough thermal vias to connect the power planes in different layers under and around the module.
2. Phase 1 and Phase 2 pads are switching nodes that generate switching noise. Keep these pads under the module. For noise-sensitive applications, it is recommended to keep phase pads only on the top and inner layers of the PCB; do not place phase pads exposed to the outside on the bottom layer of the PCB. To improve the thermal performance, the phase pads can be extended in the inner layer, as shown in Phase 1 and Phase 2 pads on layers 4 and 5 (see [Figures 7](#) and [8](#)) for this 40A evaluation board. Make sure that layers 3 and 6 have the GND layers to cover the extended areas of phase pads on layers 4 and 5 to avoid noise coupling.
3. To avoid noise coupling, we recommend adding 470pF capacitors on all COMP pins of each module for multiple module operations.
4. If the ambient temperature is high or the board space is limited, airflow is needed to dissipate more heat from the modules. A heat sink can also be applied to the top side of the module to further improve the thermal performance (heat sink recommendation: Aavid Thermalloy, part number 375424B00034G, www.aavid.com).

ISL8240MEVAL3Z Board Schematic

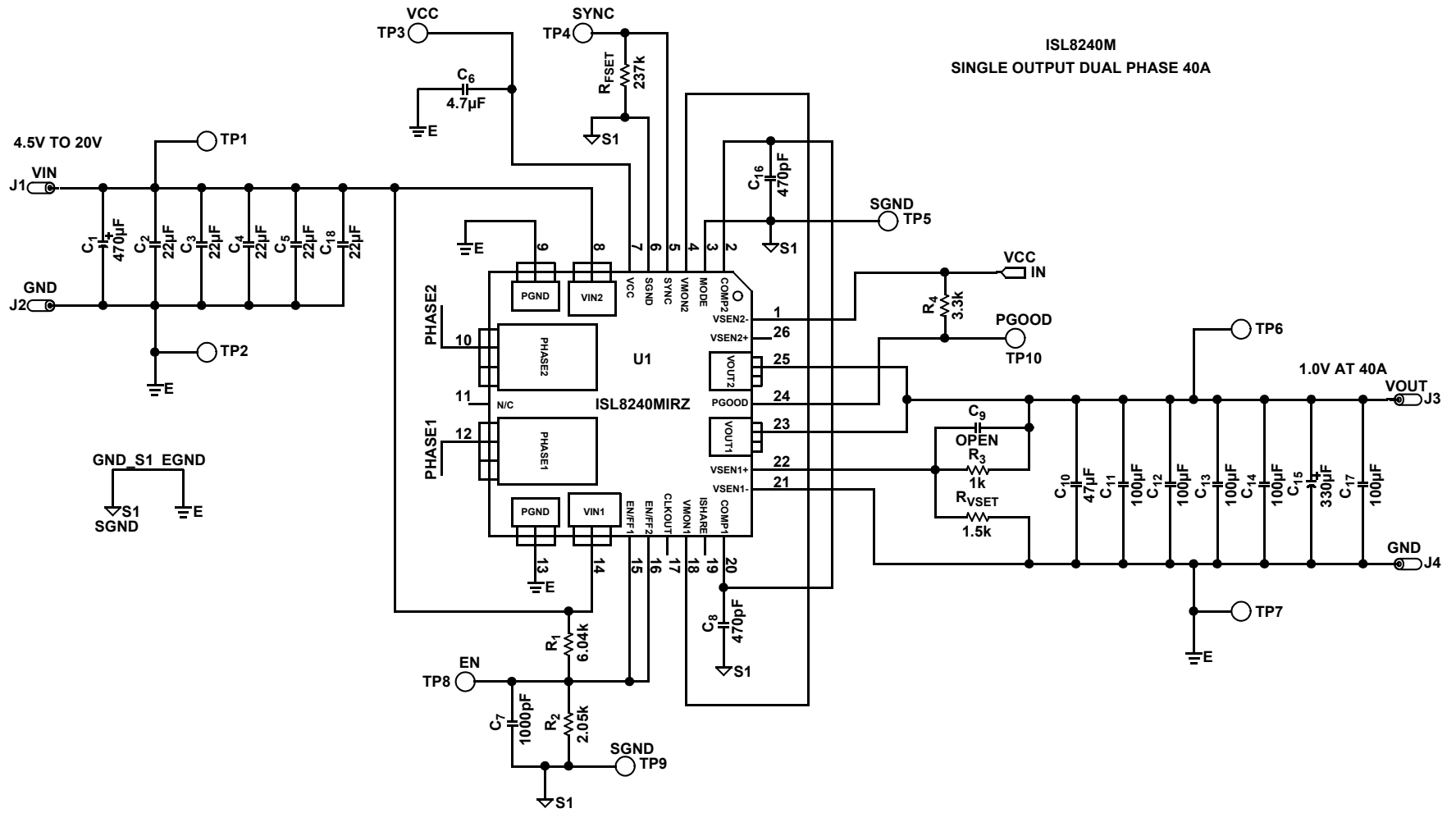

Layout

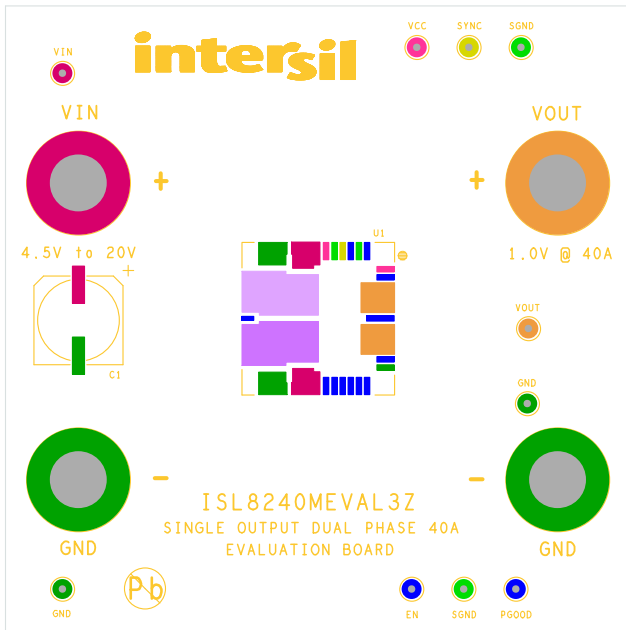

FIGURE 3. SILKSCREEN TOP

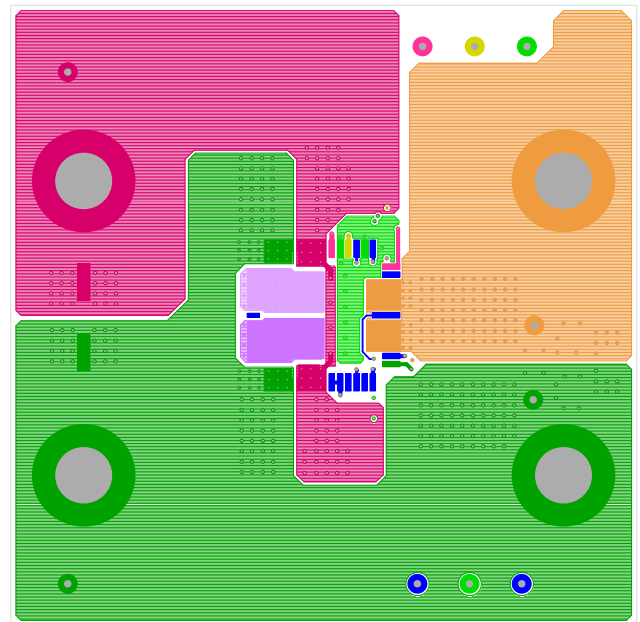

FIGURE 4. TOP LAYER COMPONENT

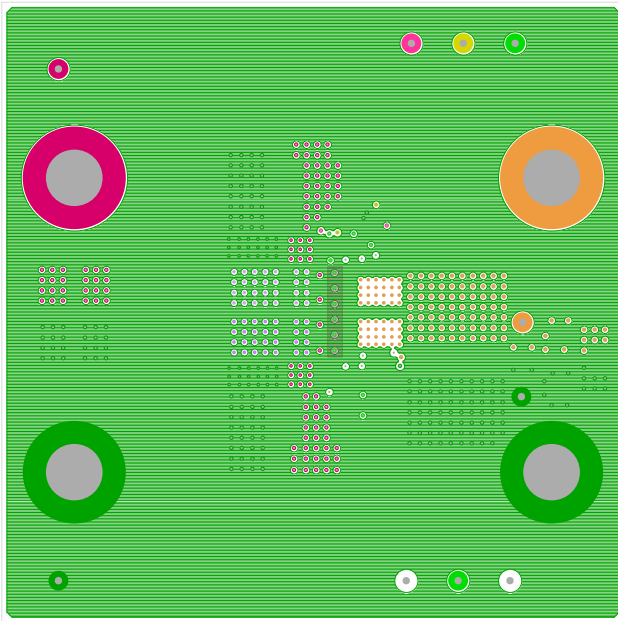

FIGURE 5. LAYER 2

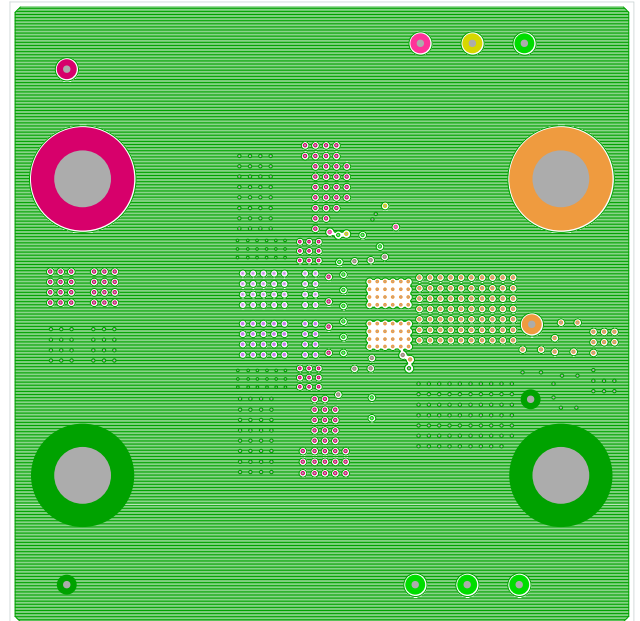

FIGURE 6. LAYER 3

Layout (Continued)

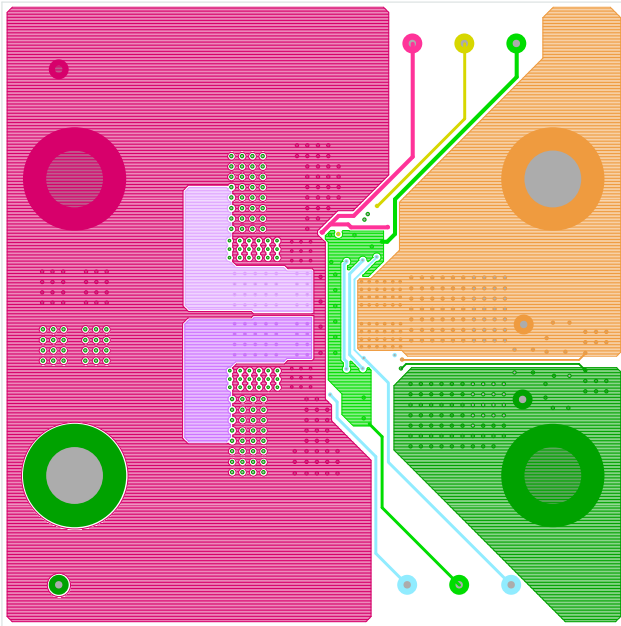

FIGURE 7. LAYER 4

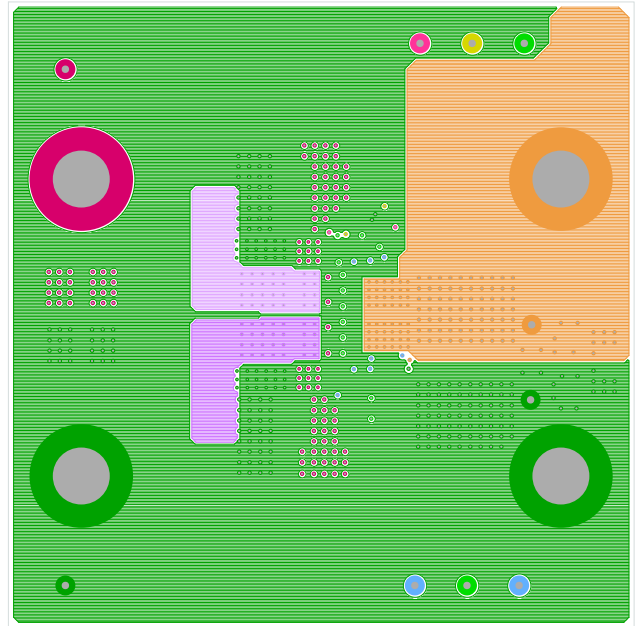

FIGURE 8. LAYER 5

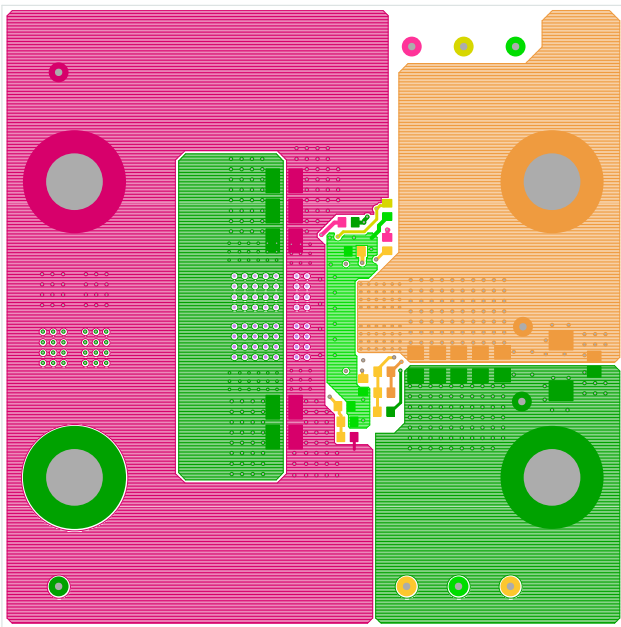

FIGURE 9. BOTTOM LAYER SOLDER SIDE

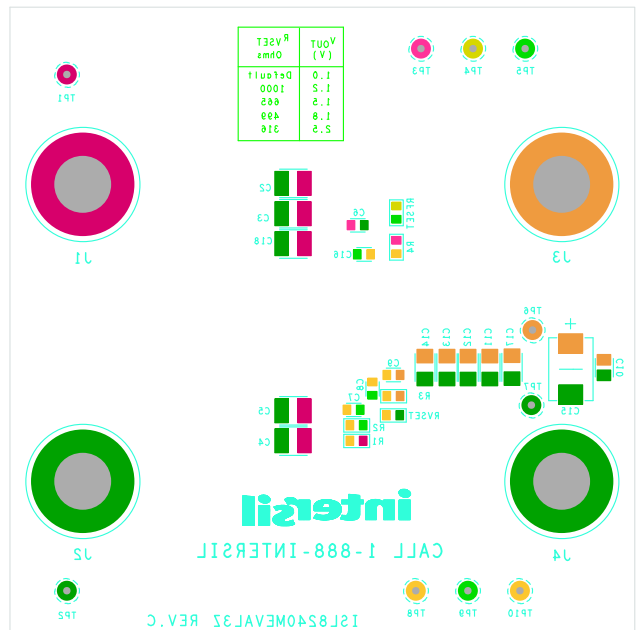

FIGURE 10. SILKSCREEN BOTTOM

Bill of Materials

MANUFACTURER PART NUMBER	REF DES	QTY.	VALUE	TOL.	VOLTAGE	POWER	PACKAGE TYPE	JEDEC TYPE	MANUFACTURER	DESCRIPTION
108-0740-001	J1-J4	4					CONN	BAN-JACK	Johnson Components	Standard type banana jack
10TPB330M	C15	1	330 μ F	20%	10V		SMD	CAP_7343_149	SANYO-POSCAP	Standard solid electrolytic chip tantalum SMD capacitor
5002	TP1-TP10	10					THOLE	MTP500X	Keystone	Miniature white test point 0.100 pad 0.040 Thole
EEE1EA471P	C1	1	470 μ F	20%	25V		SMD	CAPAE_393X402	Panasonic	Aluminum electrolytic S series type V capacitor (RoHS compliant)
GRM32ER71E226KE15L	C2-C5	4	22 μ F	10%	25V		1210	CAP_1210	Murata	Ceramic chip capacitor
H1045-00102-50V10-T	C7	1	1000pF	10%	50V		603	CAP_0603	Generic	Multilayer capacitor
H1045-00471-50V10	C8, C16	2	470pF	10%	50V		603	CAP_0603	Generic	Multilayer capacitor
H1045-00475-6R3V10-T	C6	1	4.7 μ F	10%	6.3V		603	CAP_0603	Generic	Multilayer capacitor
H1045-OPEN	C9	1	OPEN	5%	OPEN		603	CAP_0603	Generic	Multilayer capacitor
H1046-00476-6R3V20-T	C10	1	47 μ F	20%	6.3V		805	CAP_0805	Generic	Multilayer capacitor
H1065-00107-6R3V20-T	C12-C14	3	100 μ F	20%	6.3V		1206	CAP_1206	Generic	Multilayer capacitor
H1065-OPEN	C11	1	OPEN	5%	OPEN		1206	CAP_1206	Generic	Multilayer capacitor
H2511-02373-1/16W1	RFSET	1	237k Ω	1%		1/16W	603	RES_0603	Generic	Thick filmchip resistor
H2511-02051-1/10W1-T	R2	1	2.05k Ω	1%		1/10W	603	RES_0603	Generic	Thick filmchip resistor
H2511-01001-1/16W1	R3, RVSET	2	1k Ω	1%		1/16W	603	RES_0603	Generic	Thick filmchip resistor
H2511-03301-1/16W5	R4	1	3.3k Ω	5%		1/16W	603	RES_0603	Generic	Thick filmchip resistor
H2511-06041-1/16W1	R1	1	6.04k Ω	1%		1/10W	603	RES_0603	Generic	Thick filmchip resistor
ISL8240MIRZ	M1	1					QFN	QFN26_670X670_ISL8240M	Intersil	Dual 20A DC/DC power module

NOTE: Resistance accuracy of feedback resistor divider R1/R2 can affect the output accuracy. Please use high accuracy resistance (i.e. 0.5% or 0.1%) to meet the output accuracy requirement.

ISL8240MEVAL3Z Performance

Test conditions at +25°C and no air flow.

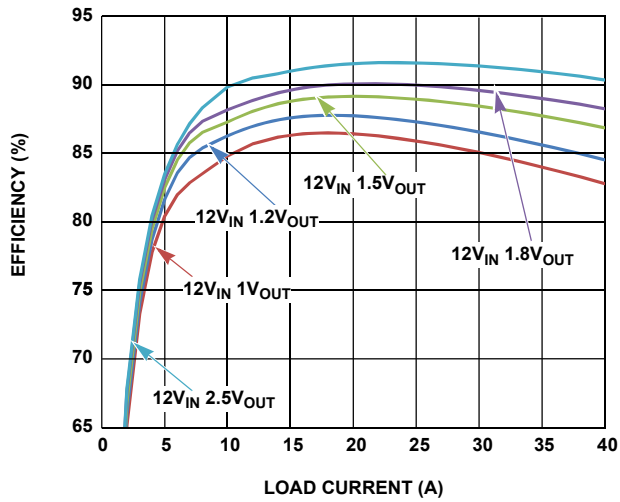

FIGURE 11. EFFICIENCY CURVES FOR 12V INPUT

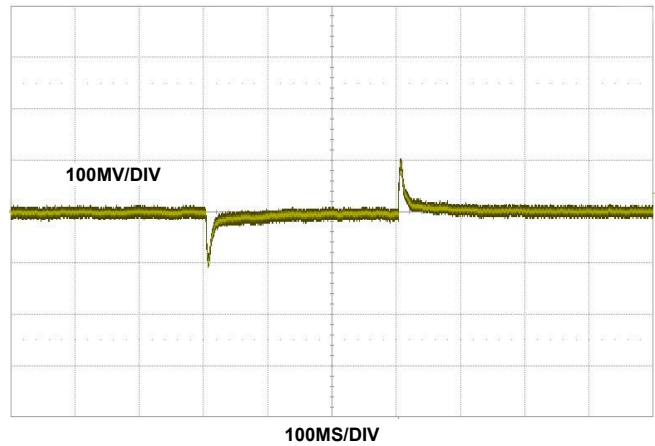

FIGURE 12. 1V_{OUT} TRANSIENT RESPONSE, I_{OUT} = 0A TO 20A, f_{SW} = 350kHz, LOAD CURRENT SLEW RATE: 10A/μs

Intersil Corporation reserves the right to make changes in circuit design, software and/or specifications at any time without notice. Accordingly, the reader is cautioned to verify that the Application Note or Technical Brief is current before proceeding.

For information regarding Intersil Corporation and its products, see www.intersil.com