



MAX17007 Evaluation Kit

General Description

The MAX17007 evaluation kit (EV kit) demonstrates the standard 12A application circuit of the MAX17007. This DC-DC converter steps down high-voltage batteries to generate low-voltage core or chipset/RAM bias supplies in notebook computers.

The default MAX17007 EV kit design provides two independent outputs (OUT1 and OUT2) from a 7V to 24V battery-input range. OUT1 is configured for a dynamic 1V/1.2V output voltage and OUT2 is configured to a preset 1.5V output voltage. Each output delivers at least 12A. The OUT1 and OUT2 outputs operate at 270kHz and 330kHz switching frequencies, respectively.

Ordering Information

| PART | TYPE |
|----------------|--------|
| MAX17007EVKIT+ | EV Kit |

+Denotes lead-free and RoHS-compliant.

Features

- ◆ 7V to 24V Input Range
- ◆ Preset/Adjustable/Dynamic Output Voltage (OUT1)
- ◆ Preset/Adjustable Output Voltage (OUT2)
- ◆ 12A Output Currents for Each Output
- ◆ 24A Output Current in Combined Mode
- ◆ 91% Efficiency ($V_{IN} = 12V$, $V_{OUT1} = 1.2V$ at 5A)
- ◆ 92% Efficiency ($V_{IN} = 12V$, $V_{OUT2} = 1.5V$ at 5A)
- ◆ Power-Good Output Indicators (PGOOD1 and PGOOD2)
- ◆ Low-Profile Surface-Mount Components
- ◆ Fully Assembled and Tested
- ◆ Lead-Free and RoHS-Compliant

Evaluates: MAX17007

Component List

| DESIGNATION | QTY | DESCRIPTION |
|--------------------------------------|-----|---|
| C1–C4 | 4 | 10 μ F \pm 10%, 25V X5R ceramic capacitors (1206) Murata GRM31CR61E106K TDK C3216X5R1E106K |
| C5, C6 | 2 | 0.1 μ F \pm 10%, 25V X7R ceramic capacitors (0603) Murata GRM188R71E104K TDK C1608X7R1E104K |
| C7, C8, C15, C16, C18, C20, C32, C33 | 0 | Not installed, ceramic capacitors (0603) |
| C9–C12 | 4 | 330 μ F \pm 20%, 2.5V, 12m Ω polymer capacitors (C2) SANYO 2R5TPE330MCC2 |
| C13, C14 | 2 | 1 μ F \pm 10%, 6.3V X5R ceramic capacitors (0603) Murata GRM188R60J105K TDK C1608X5R0J105K |
| C17, C19 | 2 | 1nF \pm 10%, 50V X7R ceramic capacitors (0603) Murata GRM188R71H102K TDK C1608X5R1H102K |

| DESIGNATION | QTY | DESCRIPTION |
|--|-----|--|
| C21–C30 | 10 | 10 μ F \pm 20%, 6.3V X5R ceramic capacitors (0603) Murata GRM188R60J106M TDK C1608X5R0J106M |
| C31 | 1 | 2.2nF \pm 10%, 50V X7R ceramic capacitor (0603) Murata GRM188R71H222K TDK C1608X7R1H222K |
| C34, C35 | 2 | 0.22 μ F \pm 10%, 25V X7R ceramic capacitors (0603) Murata GRM188R71E224K TDK C1608X7R1E224K |
| D1, D2 | 2 | 2A, 30V Schottky diodes (SMA case) Nihon EC21QS03L Central Semiconductor CMSh2-40M LEAD FREE |
| D3, D4 | 2 | Green surface-mount LEDs (0603) |
| EN1, EN2, PGOOD1, PGOOD2, REFIN1, SKIP | 6 | Miniature test points |
| JU1, JU3 | 2 | 3-pin headers (0.1in centers) |

MAX17007 Evaluation Kit

Component List (continued)

| DESIGNATION | QTY | DESCRIPTION |
|---------------|-----|--|
| JU2, JU7, JU8 | 3 | 2-pin headers (0.1in centers) |
| JU4 | 1 | 4-pin header (0.1in centers) |
| JU5, JU6 | 0 | Not installed, 4-pin headers (0.1in centers) |
| L1, L2 | 2 | 1 μ H \pm 30%, 16A, 3.25m Ω power inductors Würth 7443552100 (10mm x 10mm x 4mm) Cooper CTX03-17888-R |
| N1, N3 | 2 | n-channel MOSFETs (PowerPAK 8-pin SO) Fairchild FDMS8690 or Siliconix/Vishay Si7634DP |
| N2, N4 | 2 | n-channel MOSFETs (PowerPAK 8-pin SO) Fairchild FDS8670 Siliconix/Vishay Si7336ADP |
| N5 | 0 | Not installed, dual MOSFET (8-pin SO) |
| N7 | 1 | n-channel MOSFET (SOT23) Fairchild Semiconductor 2N7002 Central Semiconductor 2N7002 LEAD FREE |

| DESIGNATION | QTY | DESCRIPTION |
|--------------------------|-----|---|
| R1, R2, R5, R6, R19, R22 | 0 | Not installed, resistors (0603) R1, R2, R19, and R22 are short (PCB trace); R5 and R6 are open |
| R3, R4 | 2 | 1.5k Ω \pm 1% resistors (0603) |
| R7 | 1 | 80.6k Ω \pm 1% resistor (0603) |
| R8 | 1 | 249k Ω \pm 1% resistor (0603) |
| R9 | 1 | 121k Ω \pm 1% resistor (0603) |
| R10, R20, R23 | 3 | 10 Ω \pm 5% resistors (0603) |
| R11, R14, R15 | 3 | 100k Ω \pm 5% resistors (0603) |
| R12, R13 | 2 | 1k Ω \pm 5% resistors (0603) |
| R16 | 1 | 220k Ω \pm 1% resistor (0603) |
| R17 | 1 | 180k Ω \pm 1% resistor (0603) |
| R18, R21 | 2 | 3.01k Ω \pm 1% resistors (0603) |
| RT1, RT2 | 2 | 10k Ω \pm 5% NTC thermistors (0603) Panasonic ERTJ1VR103J Murata NCP18WF103J03 |
| U1 | 1 | Dual step-down SMPS controller, 28-pin thin QFN, 4mm x 4mm Maxim MAX17007GTI+ |
| — | 6 | Shunts |
| — | 1 | PCB: MAX17007 Evaluation Kit+ |

Component Suppliers

| SUPPLIER | PHONE | WEBSITE |
|--------------------------------|--------------|-----------------------|
| Central Semiconductor Corp. | 516-435-1110 | www.centalsemi.com |
| Cooper Bussmann | 561-752-5000 | www.cooperet.com |
| Fairchild Semiconductor | 408-822-2000 | www.fairchildsemi.com |
| Murata Mfg. Co., Ltd. | 770-436-1300 | www.murata.com |
| Nihon Inter Electronics Corp. | 661-867-2555 | www.niec.co.jp |
| SANYO North America Corp. | 619-661-6322 | www.sanyodevice.com |
| Siliconix/Vishay | 610-644-1300 | www.vishay.com |
| TDK Corp. | 847-390-4373 | www.component.tdk.com |
| Würth Elektronik GmbH & Co. KG | 201-785-8800 | www.we-online.com |

Note: Indicate that you are using the MAX17007 when contacting these component suppliers.

MAX17007 Evaluation Kit

Evaluates: MAX17007

Quick Start

Recommended Equipment

Before beginning, the following equipment is needed:

- 7V to 24V, 10A power supply, battery, or notebook AC adapter (V_{IN})
- DC bias power supply, 5V at 100mA (V_{DD})
- Digital multimeter

Procedure

The MAX17007 EV kit is fully assembled and tested. Follow the steps below to verify board operation.

Caution: Do not turn on the power supplies until all connections are completed.

- 1) Ensure that the EV kit is connected correctly to the supplies prior to enabling the power supplies.
- 2) Verify that shunts are installed according to Table 1.
- 3) Turn on battery power prior to 5V DC bias power; otherwise, the output UVLO timer times out and the FAULT latch is set, disabling the regulator until 5V power is cycled below 0.5V or EN is toggled.
- 4) Verify that the PGOOD1 and PGOOD2 LEDs (D3 and D4) are lit and that the OUT1 voltage measures 1.2V and the OUT2 voltage measures 1.5V.

Table 1. Default Jumper Settings

| JUMPER | SHUNT POSITION | CONFIGURATION |
|--------|----------------|-------------------|
| JU1 | 2-3 | $V_{OUT1} = 1.2V$ |
| JU2 | Installed | |
| JU3 | 1-2 | $V_{OUT2} = 1.5V$ |
| JU4 | 1-3 | Forced-PWM mode |
| JU7 | Installed | OUT1 enabled |
| JU8 | Installed | OUT2 enabled |

Note: JU6 (ILIM1) and JU5 (ILIM2) are prewired for current limits of 30mA.

Detailed Description

The MAX17007 EV kit demonstrates the features of the MAX17007 dual step-down controller. The EV kit provides a dynamic 1V/1.2V OUT1 voltage and a preset 1.5V OUT2 voltage from a 7V to 24V input. Each output provides up to a 12A load current. The OUT1 and OUT2 outputs are configured to operate at switching frequencies of 270kHz and 330kHz, respectively.

The OUT1 output can also be configured for a preset 1.05V ($REFIN1 = V_{DD}$), adjustable between 0 to 2V, or different dynamic output voltages. The OUT2 output can be configured for preset 1.5V ($FB2 = REF$) or adjustable from 0.7V to 2V by installing appropriate feedback resistors. See the *OUT1 Voltage (V_{OUT1})* and *OUT2 Voltage (V_{OUT2})* sections for more details.

The outputs can also be combined to operate as a two-phase, high-current, single-output regulator. In this mode the output is configured for either a preset, adjustable, or dynamically adjustable output voltage using $REFIN1$. See the *Combined-Mode Operation* section for more details.

Output Enable (EN1, EN2)

The MAX17007 EV kit provides access to the device's enable control pins (EN1 and EN2), through jumpers JU7 and JU8, respectively. EN1 is used to control the OUT1 output and EN2 is used to control the OUT2 output. When in combined mode, EN1 is used for output control and EN2 **must** be connected to GND. Tables 2 and 3 list the selectable jumper options for each output-enable pin.

Table 2. Jumper JU7 Functions

| SHUNT POSITION | EN1 PIN | OUT1 OUTPUT |
|----------------|------------------------------|-----------------------------------|
| 1-2* | Connected to VDD | Enabled ($V_{OUT1} = 1V/1.2V$) |
| Not installed | Connected to GND through R14 | Shutdown mode ($V_{OUT1} = 0V$) |

*Default position.

Table 3. Jumper JU8 Functions

| SHUNT POSITION | EN2 PIN | OUT2 OUTPUT |
|----------------|------------------------------|-----------------------------------|
| 1-2* | Connected to VDD | Enabled ($V_{OUT2} = 1.5V$) |
| Not installed | Connected to GND through R15 | Shutdown mode ($V_{OUT2} = 0V$) |

*Default position.

The EN1 and EN2 control pins can also be driven by an external signal by removing the shunt from JU7 or JU8 and connecting the control signal to the EN1 or EN2 test point. The output operation will depend on the external control-signal level.

MAX17007 Evaluation Kit

OUT1 Voltage (V_{OUT1})

The MAX17007 EV kit can be evaluated with OUT1 configured as a preset, adjustable, or dynamic output voltage. The OUT1 voltage (V_{OUT1}) is set to the preset voltage (1.05V) by connecting REFIN1 to VDD. For adjustable and dynamic output voltages, OUT1 is regulated to the voltage set at REFIN1. See the *Adjustable Voltage* and *Dynamic Voltage* sections for more details. Table 4 also lists the JU1 and JU2 jumper configurations for each output-voltage type.

Adjustable Voltage

The OUT1 output voltage can be adjusted up to 2V by applying a DC voltage (0 to 2V) to the REFIN1 test point. When OUT1 is used as an adjustable output voltage, remove the shunt from jumper JU1.

Dynamic Voltage

The MAX17007 regulates OUT1 to the voltage set at REFIN1. By changing the voltage at REFIN1 between two set voltages, the MAX17007 can be used in applications that require dynamic output-voltage changes. The external MOSFET (N7) is used to switch resistor R8 in and out of the REFIN1 resistor-divider network, changing the voltage at REFIN1. A logic-high on the gate turns on N7, resulting in V_{OUT1} = 1V. A logic-low on the gate turns off N7, resulting in V_{OUT1} = 1.2V. Jumper JU2 is used to control the gate of the external MOSFET (N7). To configure different dynamic output voltages, see the *Evaluating Other Dynamic Voltages* section.

Table 4. Jumper JU1 and JU2 Functions

| SHUNT POSITION | | REFIN1 PIN | OUT1 VOLTAGE |
|----------------|---------------|--|--|
| JU1 | JU2 | | |
| 1-2 | X | Connected to VDD | V _{OUT1} = 1.05V (preset) |
| 2-3* | Installed* | Connected to REF through voltage-dividers R7 and R9 | V _{OUT1} = 1.2V (dynamic) |
| | Not installed | Connected to REF through voltage-dividers R7 and (R8 R9) | V _{OUT1} = 1V (dynamic) |
| Not installed | X | Connected to an external voltage (0 to 2V) through the REFIN1 test point | V _{OUT1} = V _{REFIN1} (adjustable) |

*Default position.

X = Don't-care condition.

Evaluating Other Dynamic Voltages

The MAX17007 EV kit output is configured for dynamic voltages of 1V (V_{OUT1(LOW)}) and 1.2V (V_{OUT1(HIGH)}). However, the dynamic voltages can be adjusted between 0 and V_{REF} by selecting appropriate R7, R8, and R9 resistor values. The two voltage set points are determined by the following equations:

$$V_{OUT1(HIGH)} = \left(\frac{R9}{R7 + R9} \right) V_{REF}$$

$$V_{OUT1(LOW)} = \left(\frac{(R8 || R9)}{(R8 || R9) + R7} \right) V_{REF}$$

where V_{REF} = 2V.

OUT2 Voltage (V_{OUT2})

The MAX17007 EV kit can be evaluated with OUT2 configured as a preset or adjustable output voltage. Table 5 lists the OUT2 voltage (V_{OUT2}) options. V_{OUT2} is set to the preset voltage (1.5V) by connecting FB2 to REF and uninstalling resistors R5 and R6. To adjust V_{OUT2} from 0.7V to 2V, remove the shunt from jumper JU3 and install appropriate R5 and R6 feedback resistors. Install resistor R6 with a 10kΩ ±1% resistor and select resistor R5 according to the following equation:

$$R5 = R6 \left(\frac{V_{OUT2}}{V_{FB2}} - 1 \right)$$

where V_{FB2} = 0.7V.

Table 5. Jumper JU3 Functions

| SHUNT POSITION | FB2 PIN | OUT2 VOLTAGE |
|----------------|--|---|
| 1-2* | Connected to REF (resistors R5 and R6 should be removed) | V _{OUT2} = 1.5V (preset) |
| Not installed | Connected to OUT2 through resistor-dividers R5 and R6 | V _{OUT2} = V _{FB2} $\left(1 + \frac{R5}{R6} \right)$ (adjustable) |
| 2-3 | Connected to VDD (resistors R5 and R6 should be removed) | Combined mode selected (see the <i>Combined-Mode Operation</i> section for necessary board modifications and operation) |

*Default position.

MAX17007 Evaluation Kit

Evaluates: MAX17007

Pulse-Skipping Control Input (**SKIP**)

The MAX17007 EV kit features a 4-pin jumper (JU4) for pulse-skipping control input. This four-level input determines the mode of operation under normal steady-state conditions and dynamic output-voltage transitions. The default configuration has a shunt installed across pins 1-3 for low-noise, forced-PWM mode. Table 6 lists the other selectable jumper options. Refer to the *Modes of Operation* section in the MAX17007 IC data sheet for more information.

Table 6. Jumper JU4 Functions

| SHUNT POSITION | SKIP PIN | OPERATIONAL MODE |
|-----------------|------------------|---|
| 1-2 | Connected to GND | Pulse-skipping mode without forced PWM during transitions |
| 1-3* | Connected to VDD | Low-noise mode, forced-PWM operation |
| 1-4 | Connected to REF | Pulse-skipping mode with forced PWM during transitions |
| Not installed** | Open | Ultrasonic mode without forced PWM during transitions |

*Default position.

**Not supported in combined mode.

Valley Current-Limit Thresholds (**ILIM1, ILIM2**)

The valley current-limit thresholds for OUT1 and OUT2 are set by configuring jumpers JU6 and JU5, respectively. By default, pins 1-4 of jumpers JU5 and JU6 are shorted by a PC trace. This sets the valley current-limit threshold for each output to 30mV. To change the threshold setting, cut the PC trace between pins 1-4, install a 4-pin header, and configure the shunt according to Tables 7 or 8. Refer to the *Setting the Valley Current Limit* section in the MAX17007 IC datasheet for more information.

Table 7. Jumper JU6 Functions

| SHUNT POSITION | ILIM1 PIN | OUT1 CURRENT-LIMIT THRESHOLD (mV) |
|----------------|------------------|-----------------------------------|
| 1-2 | Connected to GND | 15 |
| 1-3 | Connected to VDD | 60 |
| 1-4* | Connected to REF | 30 |
| Not installed | Open | 45 |

*Default position.

Table 8. Jumper JU5 Functions

| SHUNT POSITION | ILIM2 PIN | OUT2 CURRENT-LIMIT THRESHOLD (mV) |
|----------------|------------------|-----------------------------------|
| 1-2 | Connected to GND | 15 |
| 1-3 | Connected to VDD | 60 |
| 1-4* | Connected to REF | 30 |
| Not installed | Open | 45 |

*Default position.

Switching Frequency (**f_{sw1}**, **f_{sw2}**)

The switching frequencies for OUT1 and OUT2 are set by external resistors R_{TON1} and R_{TON2} . By default, OUT1 is configured for a switching frequency of 270kHz and OUT2 is configured for a switching frequency of 330kHz. To reconfigure the switching frequency of either output, select the output's associated R_{TON} resistor according to the following equation:

$$T_{SW1,2} = C_{TON}(R_{TON1,2} + 6.5k\Omega)$$

$$f_{SW1,2} = \frac{1}{T_{SW1,2}}$$

where $C_{TON} = 16.26pF$.

MAX17007 Evaluation Kit

Combined-Mode Operation

The MAX17007 EV kit can be evaluated with outputs OUT1 and OUT2 operating in combined mode. In this mode, the outputs are combined to support higher output currents. To configure the MAX17007 for combined-mode operation, place a shunt across pins 2-3 of jumper JU3. Short OUT1 and OUT2 together with a low-impedance copper strap. Additional configuration requirements are listed in Table 9.

Table 9. Combined-Mode Configuration

| PIN | CONFIGURATION | DESCRIPTION |
|-------------|---|---|
| FB2 | Place shunt on pins 2-3 of JU3 | Connected to VDD to select combined mode; output voltage set by REFIN1 |
| ILIM2 (CCI) | Cut the PC trace between pins 1-4 of JU5 and install capacitor C15 with 470pF | Current-balance-compensation capacitor (refer to the MAX17007 IC data sheet for more details) |
| EN2 | Remove shunt from JU8 | Connected to GND through R15 |

Once the EV kit is configured for combined-mode operation, the PGOOD1 output is used as the power-good indicator. The configurable settings during combined-mode operation are described below:

- **Output Enable:** Controlled by the EN1 pin and configured through jumper JU7 (see Table 2). EN2 must be connected to GND.

- **Output Voltage:** Configured for a preset, adjustable, or dynamic output voltage. The output voltage is set by the voltage at REFIN1, which is set through jumpers JU1 and JU2 (see Table 4).
- **Pulse-Skipping Control Input:** Set by the $\overline{\text{SKIP}}$ pin and configured through jumper JU4. When in combined mode, ultrasonic mode is not supported (see Table 6).
- **Per-Phase Current Limit:** Set by the ILIM1 pin and configured through jumper JU6 (see Table 7).
- **Switching Frequency:** Set by resistor R16 (TON1). See the *Switching Frequency* (f_{SW1} , f_{SW2}) section for more details. The TON2 input is not used to set the switching frequency, but it cannot be left open. Install a similar value resistor in R17 (TON2) as in R16 (TON1).

Dual-MOSFET Operation

The MAX17007 EV kit can be evaluated with dual-package MOSFET N5. To evaluate OUT1 with a dual-package MOSFET, remove MOSFETs N1 and N2 and install N5. Fairchild Semiconductor's FDS6984S is an example of a dual-package MOSFET that fits the N5 pinout and orientation.

MAX17007 Evaluation Kit

Evaluates: MAX17007

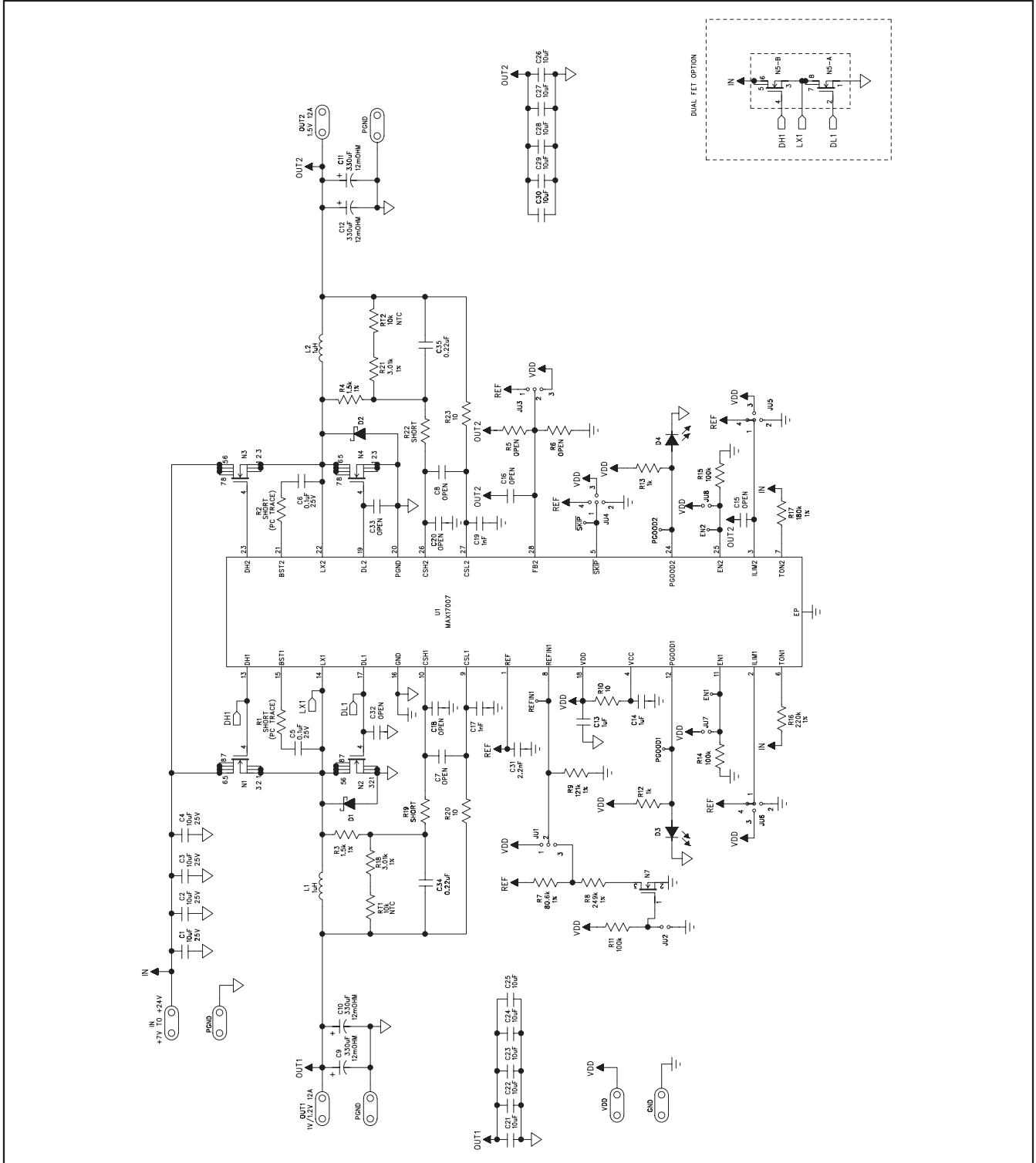

Figure 1. MAX17007 EV Kit Schematic

MAX17007 Evaluation Kit

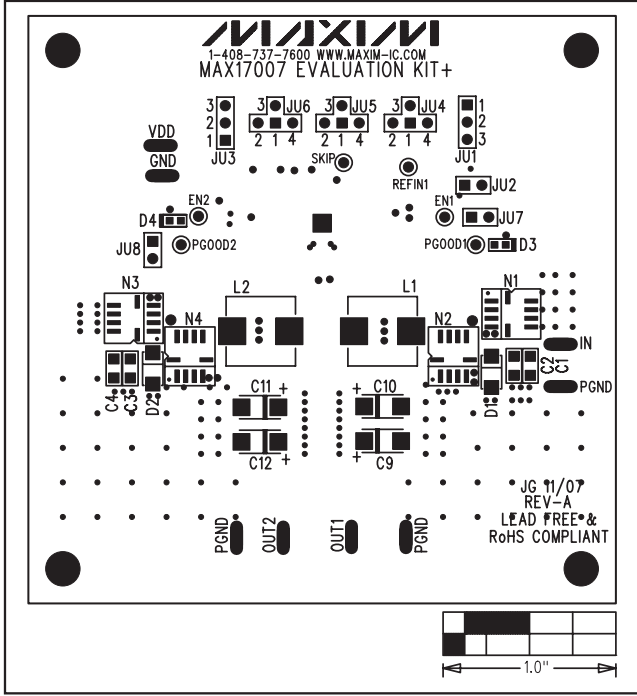

Figure 2. MAX17007 EV Kit Component Placement Guide—Component Side

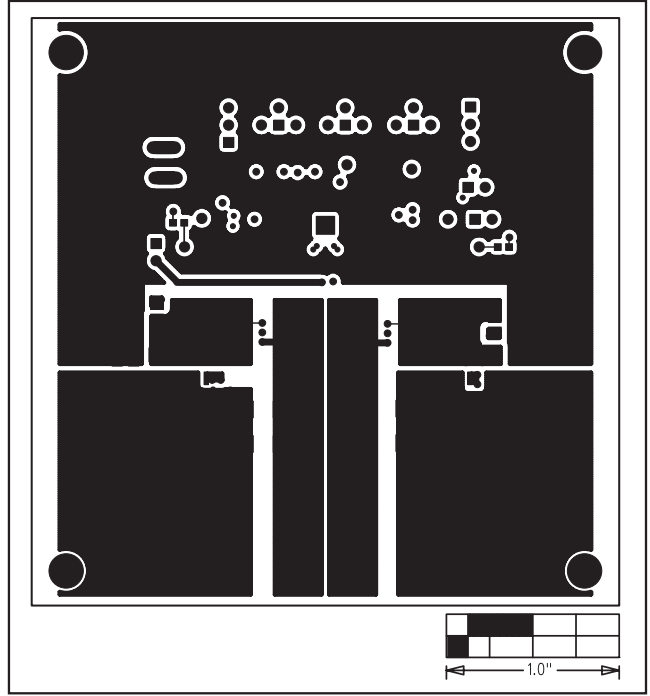

Figure 3. MAX17007 EV Kit PCB Layout—Component Side

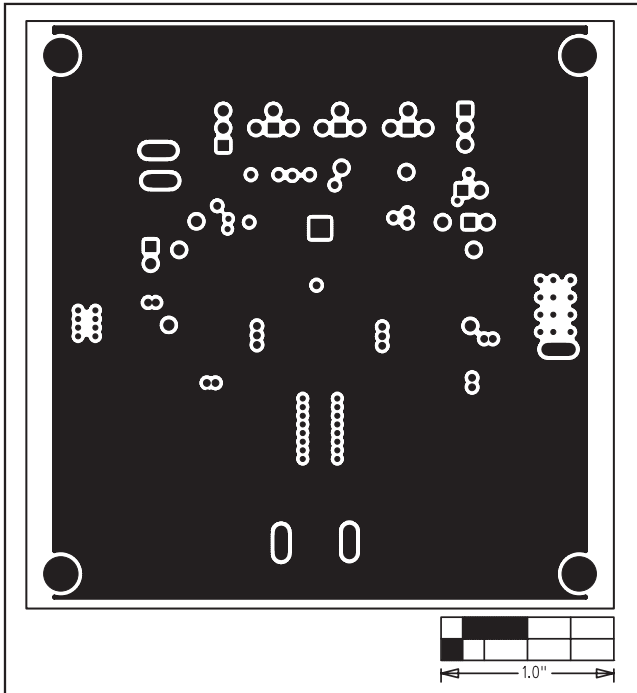

Figure 4. MAX17007 EV Kit PCB Layout—GND Layer 2

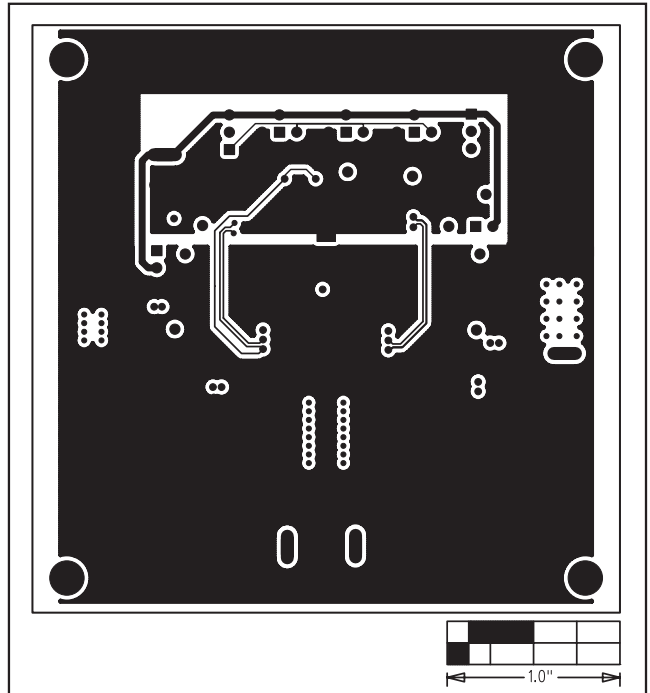

Figure 5. MAX17007 EV Kit PCB Layout—GND Layer 3

MAX17007 Evaluation Kit

Evaluates: MAX17007

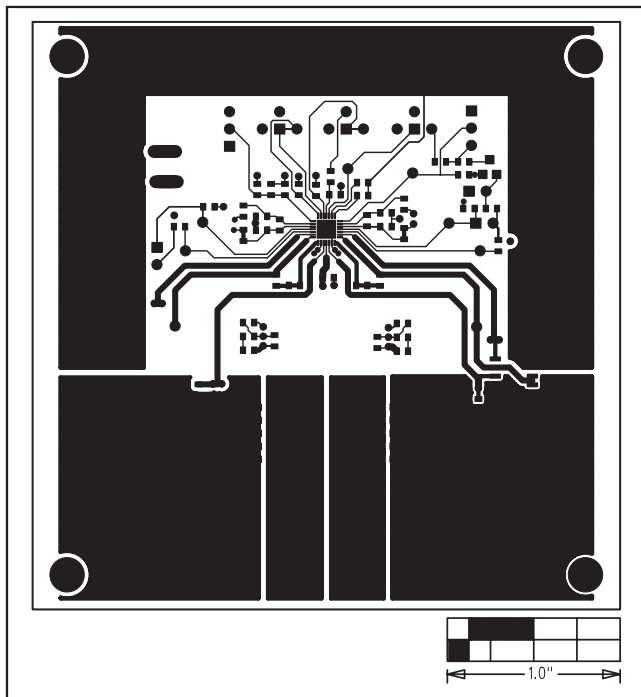

Figure 6. MAX17007 EV Kit PCB Layout—Solder Side

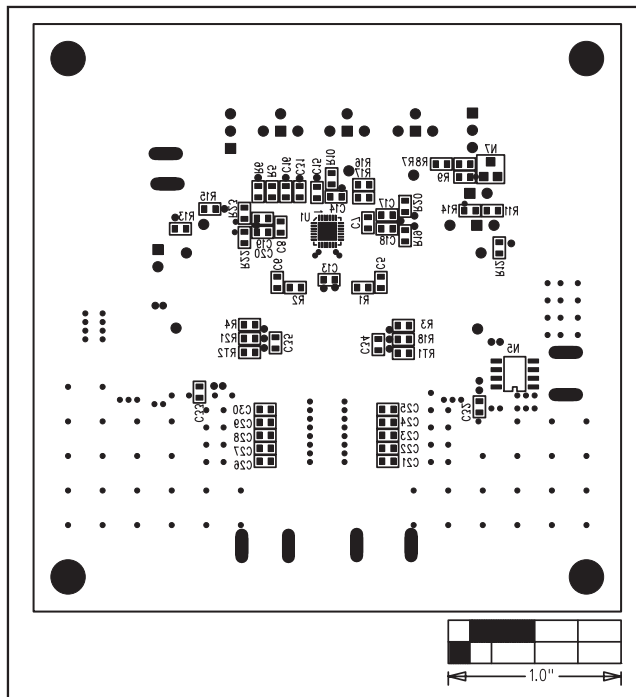

Figure 7. MAX17007 EV Kit Component Placement Guide—Solder Side

Maxim cannot assume responsibility for use of any circuitry other than circuitry entirely embodied in a Maxim product. No circuit patent licenses are implied. Maxim reserves the right to change the circuitry and specifications without notice at any time.

Maxim Integrated Products, 120 San Gabriel Drive, Sunnyvale, CA 94086 408-737-7600 _____ 9