

INSTRUCTION MANUAL

BK PRECISION®

SPECTRUM ANALYZERS

MODELS

2615A

2620A

2625

2630

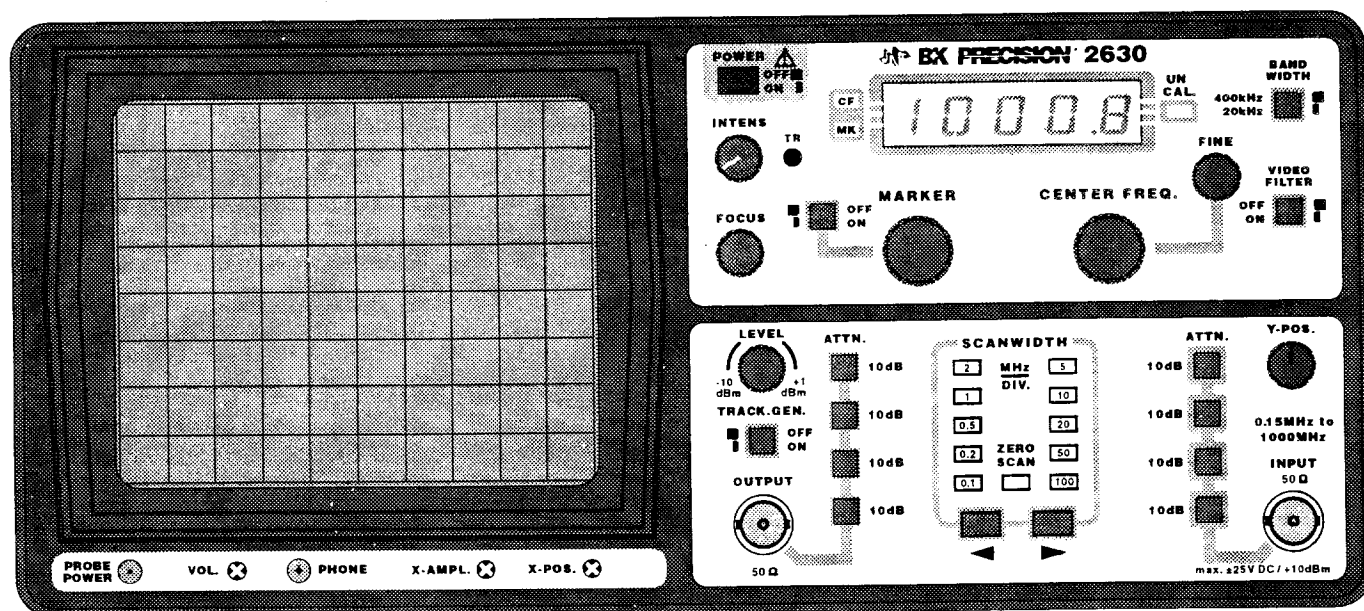

BK PRECISION®

TEST INSTRUMENT SAFETY

Normal use of test equipment exposes you to a certain amount of danger from electrical shock because testing must sometimes be performed where exposed voltage is present. An electrical shock causing 10 milliamps of current to pass through the heart will stop most human heartbeats. Voltage as low as 35 volts dc or ac rms should be considered dangerous and hazardous since it can produce a lethal current under certain conditions. Higher voltages pose an even greater threat because such voltage can more easily produce a lethal current. Your normal work habits should include all accepted practices to prevent contact with exposed high voltage, and to steer current away from your heart in case of accidental contact with a high voltage. You will significantly reduce the risk factor if you know and observe the following safety precautions:

1. Don't expose high voltage needlessly. Remove housings and covers only when necessary. Turn off equipment while making test connections in high-voltage circuits. Discharge high-voltage capacitors after removing power.
2. If possible, familiarize yourself with the equipment being tested and the location of its high voltage points. However, remember that high voltage may appear at unexpected points in defective equipment.
3. Use an insulated floor material or a large, insulated floor mat to stand on, and an insulated work surface on which to place equipment; and make certain such surfaces are not damp or wet.
4. Use the time proven "one hand in the pocket" technique while handling an instrument probe. Be particularly careful to avoid contacting a nearby metal object that could provide a good ground return path.
5. When testing ac powered equipment, remember that ac line voltage is usually present on some power input circuits such as the on-off switch, fuses, power transformer, etc. any time the equipment is connected to an ac outlet, even if the equipment is turned off.
6. Some equipment with a two-wire ac power cord, including some with polarized power plugs, is the "hot chassis" type. This includes most recent television receivers and audio equipment. A plastic or wooden cabinet insulates the chassis to protect the customer. When the cabinet is removed for servicing, a serious shock hazard exists if the chassis is touched. Not only does this present a dangerous shock hazard, but damage to test instruments or the equipment under test may result from connecting the ground lead of most test instruments to a "hot chassis". To test "hot chassis" equipment, always connect an isolation transformer between the ac outlet and the equipment under test. The **B+K Precision** Model TR-110 Isolation Transformer, or Model 1653A or 1655A AC Power Supply is suitable for most applications. To be on the safe side, treat all two-wire ac equipment as "hot-chassis" unless you are sure it has an isolated chassis or an earth ground chassis.
7. On test instruments or any equipment with a 3-wire ac power plug, use only a 3-wire outlet. This is a safety feature to keep the housing or other exposed elements at earth ground.
8. **B+K Precision** products are not authorized for use in any application involving direct contact between our product and the human body, or for use as a critical component in a life support device or system. Here, "direct contact" refers to any connection from or to our equipment via any cabling or switching means. A "critical component" is any component of a life support device or system whose failure to perform can be reasonably expected to cause failure of that device or system, or to affect its safety or effectiveness.
9. Never work alone. Someone should be nearby to render aid if necessary. Training in CPR (cardio-pulmonary resuscitation) first aid is highly recommended.

**Instruction Manual
for**

BK PRECISION[®]

**Models
2615A, 2620A, 2625, 2630
SPECTRUM ANALYZERS**

BK PRECISION[®]

TABLE OF CONTENTS

	Page		Page
TEST INSTRUMENT SAFETY	Inside front cover	INTRODUCTION TO SPECTRUM ANALYSIS . . .	15
SPECIFICATIONS	3	General	15
OPTIONAL ACCESSORIES	4	Types of Spectrum Analyzers	15
GENERAL INFORMATION	5	Spectrum Analyzer Requirements	16
Symbols	5	Frequency Measurements	16
Tilt handle	5	Resolution	16
Safety	5	Sensitivity	17
Operating Conditions	6	Video Filtering	17
Maintenance	6	Spectrum Analyzer Sensitivity	17
Selecting the Line Voltage	6	Frequency Response	18
INTRODUCTION	7	Tracking Generators	18
General	7	APPENDIX —dBm CONVERSION	20
Operating Considerations	7	CUSTOMER SUPPORT	21
CONTROLS AND INDICATORS	8	INSTRUMENT REPAIR SERVICE	21
CALIBRATION	13	WARRANTY SERVICE INSTRUCTIONS	22
Vertical Calibration	13	LIMITED ONE-YEAR WARRANTY	23
Horizontal Calibration	13		

SPECIFICATIONS

Frequency

Frequency range:

- 0.15 MHz to 1050 MHz (-3 dB) (Models 2625 and 2630)
- 0.15 MHz to 500 MHz (-3 dB) (Models 2615A and 2620A)

Center frequency display accuracy: ± 100 kHz

Marker accuracy: $\pm(0.1\%$ span + 100 kHz)

Frequency display resolution: 100 kHz

- (4½ digit LED for Models 2625 and 2630)
- (4 digit LED for Models 2615A and 2620A)

Frequency scanwidth:

- 100 kHz/div. to 100 MHz/div. (Models 2625 and 2630)
in 1-2-5 steps and 0 Hz/div. (Zero Scan)
 - 50 kHz/div. to 50 MHz/div. (Models 2615A and 2620A)
in 1-2-5 steps and 0 Hz/div. (Zero Scan)
- Frequency scanwidth accuracy: $\pm 10\%$

Frequency stability: Drift: <150 kHz / hour

IF-Bandwidth (-3 dB):

- Resolution: 400 kHz and 20 kHz
(Models 2625 and 2630)
 - Resolution: 250 kHz and 20 kHz
(Models 2615A and 2620A)
- Video-Filter on: 4 kHz

Sweep rate: 43 Hz

Amplitude

Amplitude range: -100 dBm to +13 dBm

Screen display range: 80 dB (10 dB / div.)

Reference level: -27 dBm to +13 dBm
(in 10 dB steps)

Reference level accuracy: ± 2 dB

Average noise level:

- 99 dBm (20 kHz BW) (Models 2625 and 2630)
- 99 dBm (20 kHz BW) (Models 2615A and 2620A)

Distortion:

- <-75 dBc; 2nd and 3rd harmonic
- 3rd order intermod.: -70 dBc
(two signals >3 MHz apart)

Sensitivity: dB above average noise level

Log scale fidelity: ± 2 dB (without attn.) Ref.: 250 MHz

IF gain: 10 dB adjustment range

Input

Input impedance: 50 Ω

Input connector: BNC

Input attenuator: 0 to 40 dB (4 x 10 dB steps)

Input attenuator accuracy: ± 1 dB/10 dB step

Max. input level: +10 dBm, ± 25 VDC (0 dB attenuation)
+20 dBm (40 dB attenuation)

Tracking Generator (Models 2620A and 2630 only)

Output level range: -50 dBm to +1 dBm
(in 10 dB steps and variable)

Output attenuator: 0 to 40 dB (4 x 10 dB steps)

Output attenuator accuracy: ± 1 dB

Output impedance: 50 Ω (BNC)

Frequency range:

- 0.15 MHz to 1050 MHz (Model 2630)
- 0.1 MHz to 500 MHz (Model 2620A)

Frequency response: ± 1.5 dB

Radio Frequency Interference (RFI): <20 dBc

General

Display: CRT, 6 inch, 8 x 10 div. internal graticule

Trace rotation: Adjustable on front panel

Output Probe Power: 6V

Line voltage: 115 / 230V $\pm 10\%$, 50-60Hz

Power consumption: approx. 27W

Operating ambient temperature:

- +10°C to +40°C

Protective system: Safety Class I (IEC 1010-1)

Weight:

- Approx. 15.4 lb. (6 kg) (Models 2625 and 2630)
- Approx. 13.2 lb. (5 kg) (Models 2615A and 2620A)

Dimensions:

- 4.9 in. (125 mm) H x 11.2 in. (285mm) W
x 15 in. (380 mm) D.

Accessories Supplied

- Power Cord
- Instruction Manual

OPTIONAL ACCESSORIES

Near Field "Sniffer" Probe Set; Model PR-261

The PR-261 is the ideal tool kit for the investigation of RF electromagnetic fields. It is indispensable for EMI pre-compliance testing during product development, prior to third party testing. The set includes three hand-held probes with a built-in pre-amplifier covering the frequency range from 10 kHz to 1000 MHz. The set includes one magnetic field probe, one electric field probe and one high impedance probe. All have high sensitivity and are matched to the 50Ω inputs of spectrum analyzers. The power can be supplied either from the batteries or through a power cord directly connected to a **B+K Precision** Models 2615A, 2620A, 2625 and 2630. Signal feed is via a 1.5 meter BNC-cable. When used in conjunction with a spectrum analyzer, the probes can be used to locate and qualify EMI sources. They are especially suited to locate emission "hot spots" on PCBs and cables, as well as evaluate EMC problems at the breadboard and prototype level. They enable the user to evaluate radiated fields and perform shield effectivity comparisons. Mechanical screening performance and immunity tests on cables and components are easily performed. Faulty components and poor bonding locations can be isolated.

The magnetic probe incorporates a high degree of rejection of both stray and direct electric fields, and provides far greater repeatability than with conventional field probes. Measurements can be made on the very near field area that is close to components or radiation sources. The electric field (monopole) probe has the highest sensitivity of all three probes. It can be used to check screening and perform pre-compliance testing on a comparative basis. The high impedance probe is used to measure directly on the components under test or at the conductive trace of a PC board. It has an input capacitance of only 2 pF and supplies virtually no electrical charge to the device under test.

Probe Set Specifications

All probes are electrically shielded and are supplied in a carrying case.

Frequency range: 100 kHz–1,2GHz

Power supply: 6V from Spectrum Analyzers or Batteries

Operating current: 10-15 mA

Probe dimensions: 40 x 19 x 195 mm (approx.)

Antenna Kit; Model AN-18

Broad band antenna is useful for radiated signal measurement.

Deluxe Carrying Case; Model LC-210

Rugged cordura carrying case is foam padded for instrument protection, has zipped pockets for manual and accessories, and includes web hand strap and shoulder strap.

Viewing Hood; Model VH-26

Shades CRT to block ambient light and improve definition of the display.

50-ohm to 75-ohm Matching Network; Model ZTF-1

Most RF networks (except cable TV) have an impedance of 50 ohms. The spectrum analyzers also have a 50 ohm input impedance, which allows direct connection. Cable TV networks have an impedance of 75 ohms. To use the spectrum analyzer with 75 ohm networks, Model ZTF-1 will match the 75 ohm network to the 50 ohm input impedance of the spectrum analyzer.

50-ohm Feedthru Termination; Model TE-26

The output levels of the tracking generator of the Models 2620 and 2630 are correct only when terminated into 50 ohms. The Model TE-26 provides a 50 ohm termination and a BNC feedthru connection so that the tracking generator output may be fed into high impedance circuit at a calibrated level.

Rack Mount Adapter; Model RM-26

Model RM-26 mounts the spectrum analyzer to standard 19-inch racks.

GENERAL INFORMATION

The Models 2615A, 2620A, 2625, and 2630 spectrum analyzers are easy to operate. The logical arrangement of the controls allows anyone to quickly become familiar with the operation of the instrument, however, experienced users are also advised to read through these instructions so that all functions are understood. Immediately after unpacking, the instrument should be checked for mechanical damage and loose parts in the interior. If there is transport damage, the supplier must be informed immediately. The instrument must then not be put into operation.

Symbols



ATTENTION - refer to manual



Danger - High voltage



Protective ground (earth) terminal

Tilt handle

To view the screen from the best angle, there are three different positions (C, D, E) for setting up the instrument (see Figure 1). If the instrument is set down on the floor after being carried, the handle automatically remains in the upright carrying position (A). In order to place the instrument onto a horizontal surface, the handle should be turned to the upper side of the Spectrum Analyzer (C). For the D position (10° inclination), the handle should be turned to the opposite direction of the carrying position until it locks in place automatically underneath the instrument. For the E position (20° inclination), the handle should be pulled to release it from the D position and swing backwards until it locks once more. The handle may also be set to a position for horizontal carrying by turning it to the upper side to lock in the B position. At the same time, the instrument must be lifted, because otherwise the handle will jump back.

Safety

This instrument has been designed and tested in accordance with *IEC Publication 1010-1, Safety requirements for electrical equipment for measurement, control, and laboratory use*. The CENELEC regulations EN 61010-1 correspond to this standard. It has left the factory in a safe condition. This instruction manual contains important information and warnings which have to be followed by the user to ensure safe

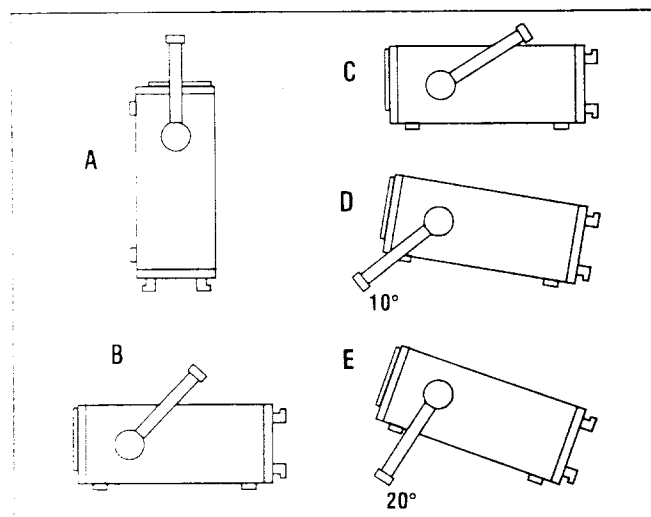

Fig. 1. Tilt Handle Operation

operation and to retain the Spectrum Analyzer in a safe condition. The case, chassis and all measuring terminals are connected to the protective earth contact of the appliance inlet. The instrument operates according to **Safety Class I** (three-conductor power cord with protective earthing conductor and a plug with earthing contact). The mains/line plug shall only be inserted in a socket outlet provided with a protective earth contact. The protective action must not be negated by the use of an extension cord without a protective conductor.

The mains/line plug should be inserted before connections are made to measuring circuits. The grounded accessible metal parts (case, sockets, jacks) and the mains/line supply contacts (line/live, neutral) of the instrument have been tested against insulation breakdown with 2200V DC. Under certain conditions, 50 Hz or 60 Hz hum voltages can occur in the measuring circuit due to the interconnection with other mains/line powered equipment or instruments. This can be avoided by using an isolation transformer (Safety Class II) between the mains/line outlet and the power plug of the device being investigated. Most cathode-ray tubes develop X-rays. However, *the dose equivalent rate falls far below the maximum permissible value of 36pA/kg (0.5mR/h)*. Whenever it is likely that protection has been impaired, the instrument shall be made inoperative and be secured against any unintended operation. The protection is likely to be impaired if, for example

- shows visible damage
- fails to perform the intended measurements

GENERAL INFORMATION

- has been subjected to prolonged storage under unfavorable conditions (e.g. in the open or in moist environments)
- has been subjected to severe transport stress (e.g. in poor packaging).

Operating Conditions

The instrument has been designed for indoor use. The permissible ambient temperature range during operation is +10°C (+50°F) to +40°C (+104°F). It may occasionally be subjected to temperatures between +10°C (+50°F) and -10°C (+14°F) without degrading its safety. The permissible ambient temperature range for storage or transportation is -40°C (+14°F) to +70°C (+158°F).

The maximum operating altitude is up to 2200m. The maximum relative humidity is up to 80%.

If condensed water exists in the instrument it should be acclimatized before switching on. In some cases (e.g. instrument extremely cold) two hours should be allowed before the instrument is put into operation. The instrument should be kept in a clean and dry room and must not be operated in explosive, corrosive, dusty, or moist environments. The spectrum analyzer can be operated in any position, but the convection cooling must not be impaired. For continuous operation the instrument should be used in the horizontal position, preferably tilted upwards, resting on the tilt handle.

The specifications stating tolerances are only valid if the instrument has warmed up for 60 minutes at an ambient temperature between +15°C (+59°F) and +30°C (+86°F). Values without tolerances are typical for an average instrument.

Maintenance

Various important properties of the spectrum analyzer should be carefully checked at certain intervals. Only in this way it is certain that all signals are displayed with the accuracy on which the technical data are based.

The exterior of the instrument should be cleaned regularly with a dusting brush. Dirt which is difficult to remove on the casing and handle, the plastic and aluminum parts, can be removed with a moistened cloth (99% water +1% mild detergent). Spirit or washing benzene (petroleum ether) can be used to remove greasy dirt.

The screen may be cleaned with water or washing benzene (but not with spirit (alcohol) or solvents), it must then be wiped with a dry clean lint-free cloth. Under no circumstances may the cleaning fluid get into the instrument. The use of other cleaning agents can attack the plastic and paint surfaces.

Selecting the Line Voltage

The spectrum analyzer operates at mains/line voltages of 115V AC and 230V AC. The voltage selection switch is located on the rear of the instrument and displays the selected voltage. The correct voltage can be selected using a small screwdriver.

Remove the power cable from the power connector prior to making any changes to the voltage setting. The fuses must also be replaced with the appropriate value (see **Fuse Type**) prior to connecting the power cable. Both fuses are externally accessible by removing the fuse cover located above the 3-pole power connector.

The fuseholder can be released by pressing its plastic retainers with the aid of a small screwdriver (see Figure 2). The retainers are located on the right and left side of the holder and must be pressed towards the center. The fuse(s) can then be replaced and pressed in until locked on both sides.

Use of patched fuses or short-circuiting of the fuseholder is not permissible; **B+K Precision** assumes no liability whatsoever for any damage caused as a result, and all warranty claims become null and void.

Fuse type:

Size 5 x 20 mm; 250-Volt AC; must meet IEC specification 127, Sheet III (or DIN 41 662 or DIN 41 571, sheet 3).

Time characteristic: **time-lag**

Line voltage **115V** ~ ±10%: Fuse rating: **T 315mA**

Line voltage **230V** ~ ±10%: Fuse rating: **T 160mA**

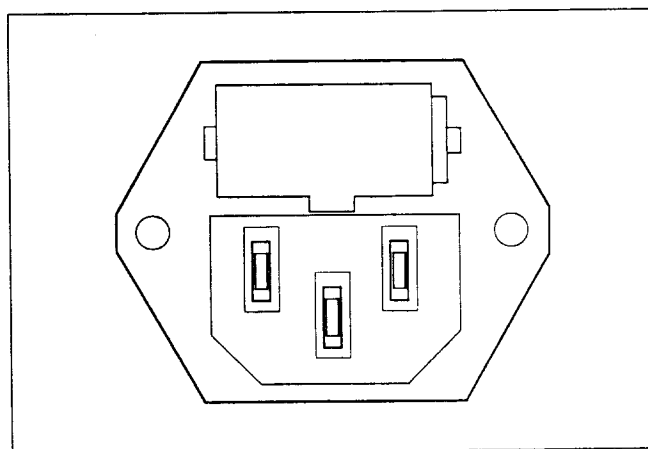

Fig. 2. Fuse Replacement

INTRODUCTION

General

The spectrum analyzer permits the detection of spectrum components of electrical signals in the frequency range of 0.15 to 1050 MHz for Models 2625 and 2630 and 0.15 to 500 MHz for Models 2615 and 2620. The detected signal and its content have to be repetitive. In contrast to an oscilloscope operated in Yt mode, where the amplitude is displayed on the time domain, the spectrum analyzer displays amplitude on the frequency domain (Yf). The individual spectrum components of "a signal" become visible on a spectrum analyzer. The oscilloscope would display the same signal as one resulting waveform.

Models 2625 and 2630

The spectrum analyzer works according to the triple superhet receiver principle. The signal to be measured ($f_{in} = 0.15$ MHz to 1050 MHz) is applied to the 1st mixer where it is mixed with the signal of a variable voltage controlled oscillator (f_{LO} 1350 MHz – 2350 MHz). This oscillator is called the 1st LO (local oscillator). The difference between the oscillator and the input frequency ($f_{LO} - f_{in} = 1st\ IF$) is the first intermediate frequency, which passes through a waveband filter tuned to a center frequency of 1350 MHz. It then enters an amplifier, and this is followed by two additional mixing stages, oscillators and amplifiers. The second IF is 29.875 MHz and the third is 2.75 MHz. In the third IF stage, the signal can be selectively transferred through a filter with 400 kHz or 20 kHz bandwidth before arriving at an AM demodulator. The logarithmic output (video signal) is transferred directly, or via a low pass filter to another amplifier. This amplifier output is connected to the Y deflection plates of the CRT.

Models 2615A and 2620A

The spectrum analyzer works according to the triple superhet receiver principle. The signal to be measured ($f_{in} = 0.5$ MHz to 500 MHz) is applied to the 1st mixer where it is mixed with the signal of a variable voltage controlled oscillator (f_{LO} 610 MHz – 1110 MHz). This oscillator is called the 1st LO (local oscillator). The difference between the oscillator and the input frequency ($f_{LO} - f_{in} = 1st\ IF$) is the first intermediate frequency, which passes through a waveband filter tuned to a center frequency of 609.5 MHz. It then enters an amplifier, and this is followed by two additional mixing stages, oscillators and amplifiers. The second IF is 29.5 MHz and the third is 2.9 MHz. In the third IF stage, the signal can be selectively transferred through a filter with 250 kHz or 20 kHz bandwidth before arriving at an AM demodulator. The logarithmic output (video signal) is transferred directly, or via a low pass filter to another amplifier. This amplifier output is connected to the Y deflection plates of the CRT.

The X deflection is performed with a ramp generator voltage. This voltage can also be superimposed on a dc voltage which allows for the control of 1st LO. The spectrum analyzer scans a frequency range depending on the ramp height. This span is

determined by the scanwidth setting. In ZERO SCAN mode only the direct voltage controls the 1st LO.

Models 2620A and 2630 each include a tracking generator. This generator provides sine wave voltages within the frequency range of 0.1 to 1050 MHz for Model 2630 and 0.1 to 500 MHz for Model 2620A. The tracking generator frequency is determined by the first oscillator (1st LO) of the spectrum analyzer section. Spectrum analyzer and tracking generator are frequency synchronized.

Operating Considerations

It is very important to read **Safety** in the GENERAL INFORMATION Section including the instructions prior to operating the spectrum analyzer. No special knowledge is necessary for the operation of the spectrum analyzer. The straightforward front panel layout and the limitation to basic functions guarantee efficient operation immediately. To ensure optimum operation of the instrument, some basic instructions need to be followed.

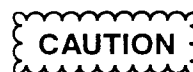

The most sensitive component of the spectrum analyzer is the input section. It consists of the signal attenuator and the first mixer. Without input attenuation, the voltage at the input must not exceed +10 dBm (0.7Vrms) AC or ±25 volt DC. With a maximum input attenuation of 40 dB the AC voltage must not exceed +20 dBm.

Exceeding these limits will damage the input attenuator and/or the first mixer.

Prior to examining unidentified signals, the presence of unacceptable high voltages has to be checked. It is also recommended to start measurements with the highest possible attenuation and a maximum frequency range. The user should also consider the possibility of excessively high signal amplitudes outside the covered frequency range, although not displayed (e.g. 1200 MHz). The frequency range of 0 Hz to 150 kHz is not specified. Spectral lines within this range would be displayed with incorrect amplitude.

A particularly high intensity setting shall be avoided. The way signals are displayed on the spectrum analyzer typically allows for any signal to be recognized easily, even with low intensity.

Due to the frequency conversion principle, a spectral line is visible at 0Hz. It is called IF-feedthrough. The line appears when the 1st LO frequency passes the IF amplifiers and filters. The level of this spectral line is different in each instrument. A deviation from the full screen does not indicate a malfunctioning instrument.

CONTROLS AND INDICATORS

The front panel controls of the instruments are shown in Figures 3 through 6 and are explained below.

1. **FOCUS.** Beam sharpness adjustment.
2. **INTENS.** Beam intensity adjustment.
3. **POWER** (Power ON and OFF). If power is switched to ON position, a beam will be visible on the screen after approximately 10 sec..
4. **TR (Trace Rotation).** Despite Mumetal-shielding of the CRT, effects of the earth's magnetic field on the horizontal trace position cannot be completely avoided. A potentiometer accessible through an opening can be used for correction. Slight pincushion distortion is unavoidable and cannot be corrected.
5. **MARKER - ON/OFF switch.** When the **MARKER** pushbutton is set to the **OFF** position, the **CF** indicator is lit and the display shows the center frequency. When the switch is in the **ON** position, **MK** is lit and the display shows the marker frequency. The marker is shown on the screen as a sharp peak. The marker frequency is adjustable by means of the **MARKER** knob and can be aligned with a spectral line.

NOTE

Switch off the marker before taking correct amplitude readings.

6. **CF/MK(CENTER FREQUENCY/ MARKER) indicator.** The **CF** LED is lit when the digital display shows the center frequency. The center frequency is the frequency which is displayed in the horizontal center of the CRT. The **MK** LED is lit when the Marker pushbutton is in the **ON** position. The digital display shows the marker frequency in that case.
7. **DIGITAL DISPLAY (Display of CenterFrequency/ Marker Frequency)** 7-segment display with 100 kHz resolution.
8. **UNCAL.** Blinking of this LED indicates incorrectly displayed amplitude values. This is due to scanwidth and filter setting combinations which give uncalibrated amplitude readings because the IF-filters have not settled. This may occur when the scanned frequency range (**SCANWIDTH**) is too large compared to the IF bandwidth, and/or the video filter bandwidth. Measurements in this case can either be taken without a video filter or the scanwidth has to be decreased .

9. **CENTER FREQUENCY – Coarse/Fine.** Both rotary knobs are used for center frequency setting. The center frequency is displayed at the horizontal center of the screen.
10. **BANDWIDTH.** Selects the IF bandwidth. When the switch is engaged, the noise level decreases and the selectivity is improved. Spectral lines which are relatively close together can be distinguished. As the small signal transient response requires a longer time, this causes incorrect amplitude values if the scanwidth is set at too wide a frequency span. The **UNCAL** LED will indicate this condition.
11. **VIDEO FILTER.** The video filter may be used to reduce noise on the screen. It enables small level spectral lines to become visible which normally would be within or just above the medium noise level. The filter bandwidth is 4 kHz.
12. **Y-POS.** Control for adjusting the vertical beam position.
13. **INPUT.** The BNC 50Ω input of the spectrum analyzer. Without input attenuation the maximum permissible input voltages of ±25V DC and +10 dBm AC must not be exceeded. With the maximum input attenuation of 40 dB the maximum input voltage is +20 dBm.

The maximum dynamic range of the instrument is 70 dB. Higher input voltages exceeding the reference level cause signal compression and intermodulation. Those effects will lead to erroneous displays. If the input level exceeds the reference level, the input level attenuation must be increased.
14. **ATTN. (ATTENUATOR).** The Input Attenuator consists of four 10 dB attenuators, reducing the signal height before entering the 1st mixer. Each attenuator is active if the push button is depressed.

The correlation of selected attenuation, reference level and baseline level (noise level) is according to the following listing:

Attenuation	Reference level		Base line
0 dB	-27 dBm	10 mV	-107 dBm
10 dB	-17 dBm	31.6 mV	-97 dBm
20 dB	-7 dBm	0.1 V	-87 dBm
30 dB	+3 dBm	316 mV	-77 dBm
40 dB	+13 dBm	1 V	-67 dBm

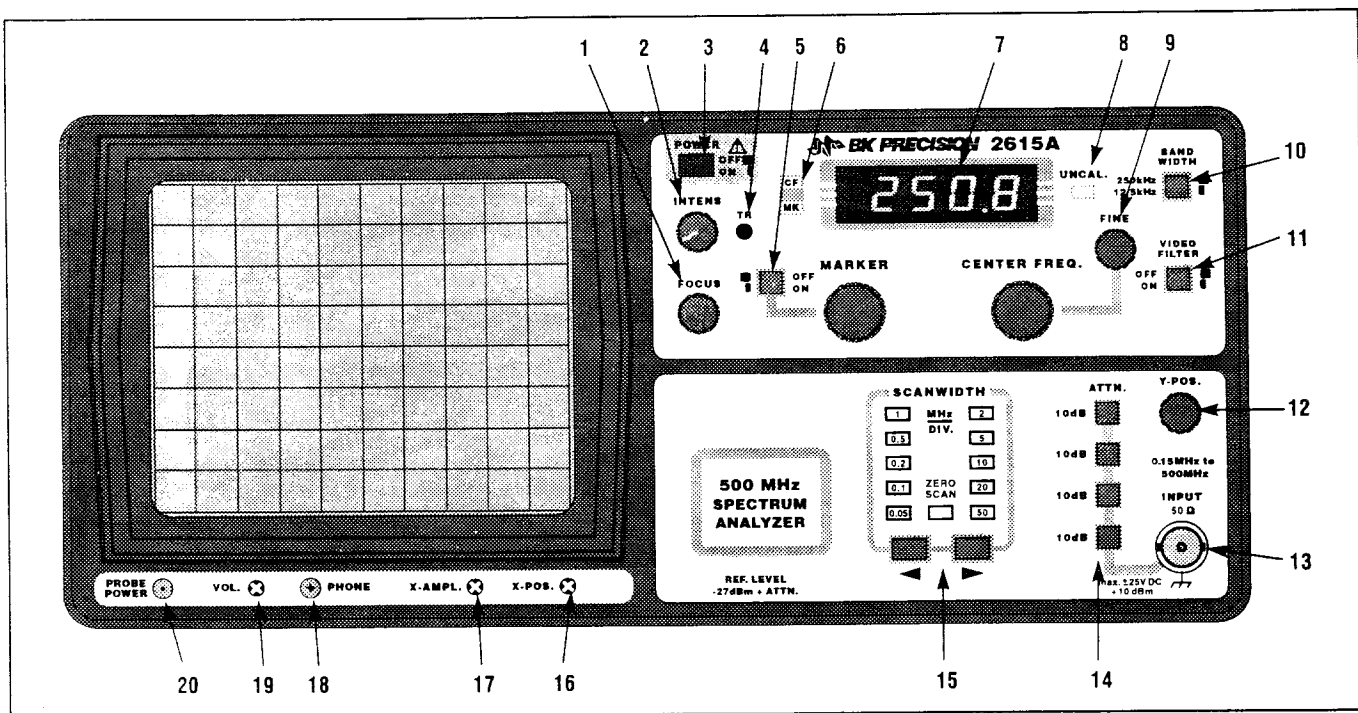

Fig. 3. Model 2615A Front Panel

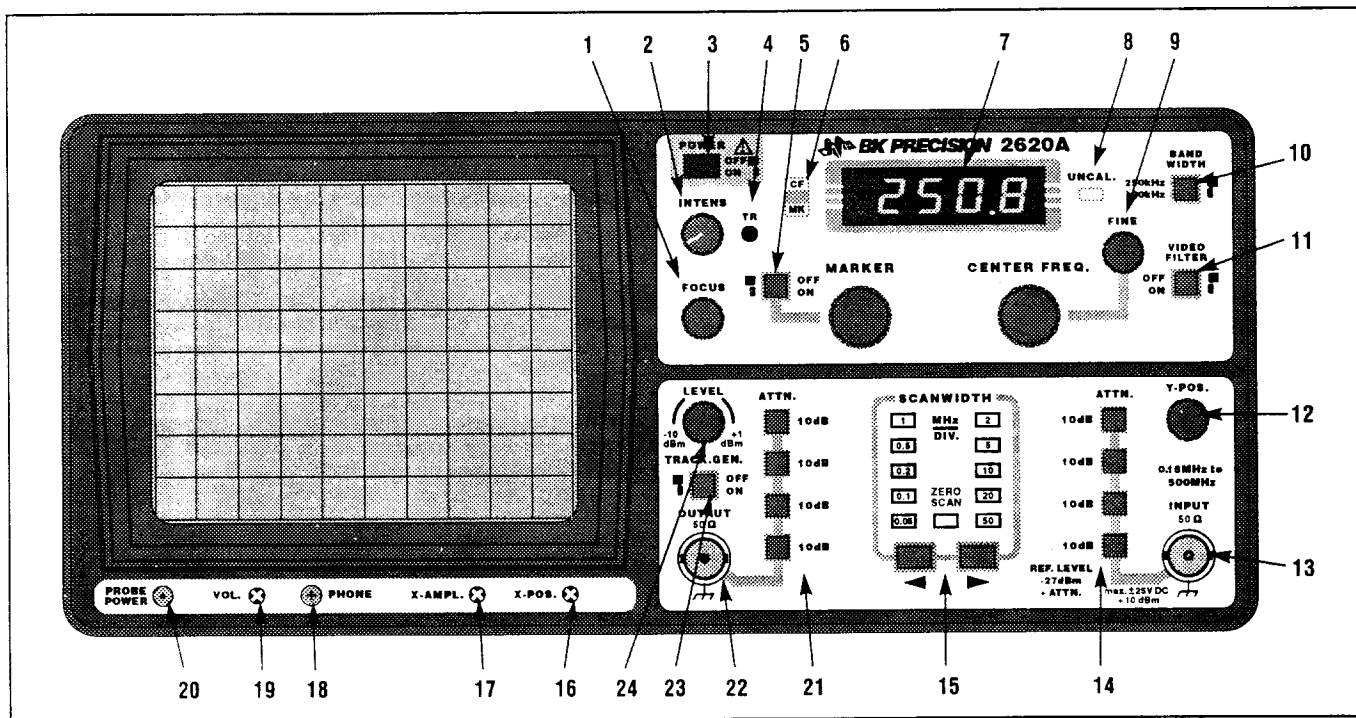

Fig. 4. Model 2620A Front Panel

The reference level is represented by the upper horizontal graticule line. The lowest horizontal graticule line indicates the baseline. The vertical graticule is subdivided in 10 dB steps.

As previously pointed out, the maximum permissible input voltages may not be exceeded. This is extremely important because it is possible that the spectrum analyzer will only show a partial spectrum of currently

CONTROLS AND INDICATORS

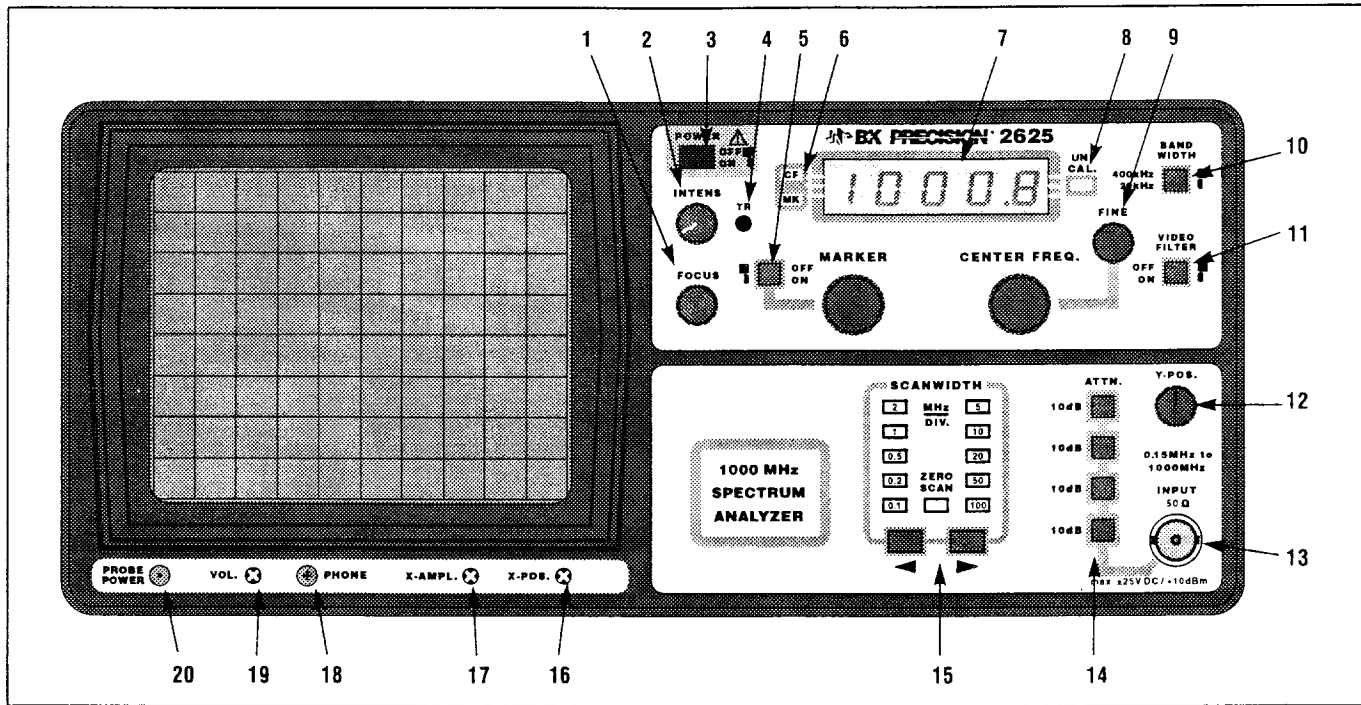

Fig. 5. Model 2625 Front Panel

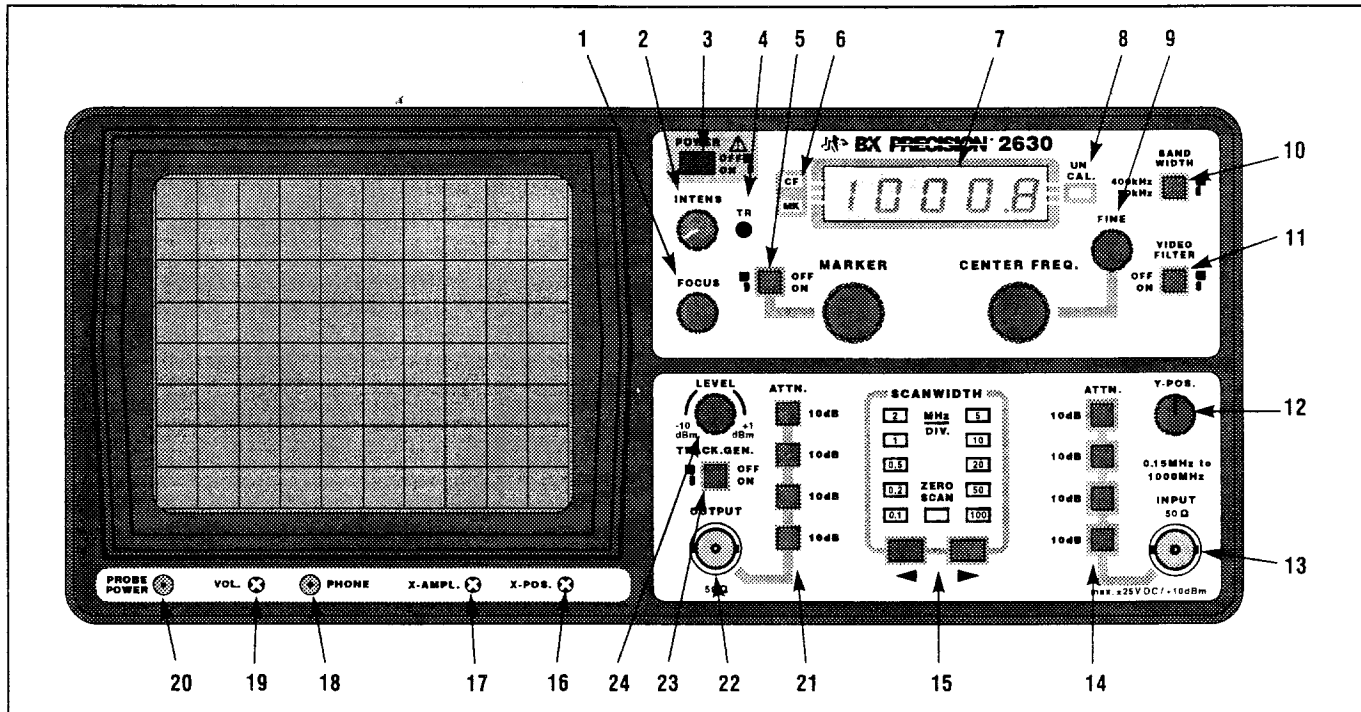

Fig. 6. Model 2630 Front Panel

applied signals. Consequently, input signals might be applied with excessive levels outside the displayed frequency range leading to the destruction of the input attenuator and/or the 1st mixing stage. Also refer to **INPUT**.

The highest attenuation (4 x 10 dB) and the highest usable frequency range (highest scanwidth setting) should be selected prior to connecting any signal to the input. This permits the detection of any spectral lines

which are within the maximum measurable and displayable frequency range, if the center frequency is set to 500 MHz for Models 2625 and 2630 or 250 MHz for Models 2615A and 2620A. If the baseline tends to move upwards when the attenuation is decreased, it may indicate spectral lines outside the maximum displayable frequency range with excessive amplitude.

15. **SCANWIDTH (Models 2625 and 2630)** The SCANWIDTH selectors allow to control the scanwidth per division of the horizontal axis. The frequency/Div. can be increased by means of the ► button, and decreased by means of the ◀ button. Switching is accomplished in 1-2-5 steps from 100 kHz/div. to 100 MHz/div.

The width of the scan range is displayed in MHz/div. and refers to each horizontal division on the graticule. The center frequency is indicated by the vertical graticule line at middle of the horizontal axis. If the center frequency and the scanwidth setting are correct, the X axis has a length of 10 divisions. On scanwidth settings lower than 100 MHz, only a part of the entire frequency range is displayed.

When SCANWIDTH is set to 100 MHz/div. and if center frequency is set to 500 MHz, the displayed frequency range extends to the right by 100 MHz per division, ending at 1000 MHz (500 MHz+(5 x 100 MHz)). The frequency decreases to the left in a similar way. In this case the left graticule line corresponds to 0Hz.

With these settings, a spectral line is visible which is referred to as "Zero Frequency". It is the 1st LO (oscillator) which becomes visible when its frequency passes the first IF filter. This occurs when the center frequency is low relative to the scanwidth range selected. The "Zero Frequency" is different in level in every instrument and therefore cannot be used as a reference level. Spectral lines displayed left of the "Zero Frequency Point" are so called image frequencies.

In the ZERO SCAN mode the spectrum analyzer operates like a receiver with selectable bandwidth. The frequency is selected via the CENTER FREQ. knob. Spectral line(s) passing the IF filter cause a level display (selective voltmeter function).

The selected scanwidth/div. settings are indicated by a number of LEDs above the range setting push buttons.

15. **SCANWIDTH (Models 2615A and 2620A)**. The SCANWIDTH selectors allow to control the scanwidth per division of the horizontal axis. The frequency/Div. can be increased by means of the ► button, and decreased by means of the ◀ button. Switching is accomplished in 1-2-5 steps from 50 kHz/div. to 50 MHz/div.

The width of the scan range is displayed in MHz/div. and refers to each horizontal division on the graticule. The

center frequency is indicated by the vertical graticule line at middle of the horizontal axis. If the center frequency and the scanwidth setting are correct, the X axis has a length of 10 divisions. On scanwidth settings lower than 50 MHz, only a part of the entire frequency range is displayed.

When SCANWIDTH is set to 50 MHz/div. and if center frequency is set to 250 MHz, the displayed frequency range extends to the right by 50 MHz per division, ending at 500 MHz (250 MHz+(5 x 50 MHz)). The frequency decreases to the left in a similar way. In this case the left graticule line corresponds to 0Hz.

With these settings, a spectral line is visible which is referred to as "Zero Frequency". It is the 1st LO (oscillator) which becomes visible when its frequency passes the first IF filter. This occurs when the center frequency is low relative to the scanwidth range selected. The "Zero Frequency" is different in level in every instrument and therefore cannot be used as a reference level. Spectral lines displayed left of the "Zero Frequency Point" are so called image frequencies.

In the ZERO SCAN mode the spectrum analyzer operates like a receiver with selectable bandwidth. The frequency is selected via the CENTER FREQ. knob. Spectral line(s) passing the IF filter cause a level display (selective voltmeter function).

The selected scanwidth/div. settings are indicated by a number of LEDs above the range setting push buttons.

16. **X-POS.** (X-position).

17. **X-AMPL.** (X-amplitude).

IMPORTANT: These controls are only necessary when calibrating the instrument. They do not require adjustment under normal operating conditions. A very accurate RF Generator is necessary if any adjustment of these controls is required.

18. **PHONE (3.5 mm earphone connector)**. An earphone or loudspeaker with an impedance >16 Ohms can be connected to this output. When tuning the spectrum analyzer to a spectral line possibly available audio signals can be detected. The signal is provided by an AM-Demodulator in the IF-section. It demodulates any available AM-Signal and provides as well one-side FM-Demodulation. The output is short circuit proof.

19. **VOLUME.** Volume setting for earphone output.

20. **PROBE POWER.** The output provides a +5 Vdc voltage for the operation of an PR-261 near field sniffer probe. It is only provided for this purpose and requires a special cable which is shipped along with the PR-261 probe set.

CONTROLS AND INDICATORS

TRACKING GENERATOR CONTROLS (Models 2620A and 2630)

21. **ATTN. (ATTENUATOR)**. Output level attenuator with four 10 dB attenuators which allow the signal to be reduced prior to reaching the **OUTPUT** jack.

The four attenuators are equal and each is activated by depressing the button. When engaged, each provides a 10 dB attenuation. Any combination of buttons may be used to achieve the desired attenuation.

22. **OUTPUT**. 50 Ω BNC output of the tracking generator

23. **TRACK GEN**. The tracking generator is activated when this button is engaged. When activated, a sine signal can be obtained at the **OUTPUT** BNC connector at a frequency determined by the spectrum analyzer. In **ZERO SCAN** mode, the center frequency appears at the output.

24. **LEVEL**. This knob adjusts the level of the tracking generator. Continuously variable from -10 dBm to +1 dBm; operates in conjunction with step attenuators for +1 dBm to -50 dBm output level.

CALIBRATION

Vertical Calibration (Models 2625 and 2630)

Prior to calibration, ensure that all input attenuators (14) are released. The spectrum analyzer must be in operation for at least 60 minutes prior to calibration. Switch **VIDEO FILTER** (11) to **OFF** position. Set **BANDWIDTH** (10) to 400 kHz. Set **SCANWIDTH** (15) to 2 MHz/div.

Connect calibrated RF signal of $-27 \text{ dBm} \pm 0.2 \text{ dB}$ (10mV) to the spectrum analyzer input (13). The frequency of this signal should be between 2 MHz and 250 MHz. Set the center frequency to the signal frequency.

A: A single spectral line (-27 dBm) appears on the screen. The spectral line maximum is now adjusted with the **Y-POS.** control (12) and placed at the top graticule line of the screen. All input attenuators switches have to be released.

The following adjustment is only necessary for service purposes and if the check of this settings shows deviations of the correct settings. The y-ampl. control is located on the XY-PCB inside the instrument. In case any adjustment of the vertical amplification is necessary, please refer to the service manual.

B: Next, the generator signal must be switched back and forth between -27 dBm and -77 dBm , and the **Y-AMPL.** control adjusted so that the spectral line peak changes by 5 divisions in the vertical direction. If this results in a change of the Y-position, the calibration outlined under **A** has to be repeated. The calibrations **A** and **B** have to be repeated until an ideal adjustment is achieved.

Finally, the operation of the input attenuators (14) can be tested at a level of -27 dBm . The spectral line visible on the screen can be reduced in 4 steps of 10 dB each by activating the attenuators incorporated in the spectrum analyzer. Each 10 dB step corresponds to one graticule division on the screen. The tolerance may not exceed $\pm 1 \text{ dB}$ in all attenuation positions.

Vertical Calibration (Models 2615A and 2620A)

Prior to calibration, ensure that all input attenuators (14) are released. The spectrum analyzer must be in operation for at least 60 minutes prior to calibration. Switch **VIDEO FILTER** (11) to **OFF** position. Set **BANDWIDTH** (10) to 250 kHz. Set **SCANWIDTH** (15) to 2 MHz/div.

Connect calibrated RF signal of $-27 \text{ dBm} \pm 0.2 \text{ dB}$ (10mV) to the spectrum analyzer input (13). The frequency of this signal should be between 2 MHz and 250 MHz. Set the center frequency to the signal frequency.

A: A single spectral line (-27 dBm) appears on the screen. The spectral line maximum is now adjusted with the **Y-POS.** control (12) and placed at the top graticule line of the screen. All input attenuators switches have to be released.

B: Next, the generator signal must be switched back and forth between -27 dBm and -77 dBm , and the **Y-AMPL.** control adjusted so that the spectral line peak changes by 5 divisions in the vertical direction. If this results in a change of the Y-position, the calibration outlined under **A** has to be repeated. The calibrations **A** and **B** have to be repeated until an ideal adjustment is achieved.

Finally, the operation of the input attenuators (14) can be tested at a level of -27 dBm . The spectral line visible on the screen can be reduced in 4 steps of 10 dB each by activating the attenuators incorporated in the spectrum analyzer. Each 10 dB step corresponds to one graticule division on the screen. The tolerance may not exceed $\pm 1 \text{ dB}$ in all attenuation positions.

Horizontal Calibration (Models 2625 and 2630)

Prior to calibration ensure that all input attenuators switches (14) are released. The spectrum analyzer must be operated for at least 60 minutes prior to calibration. The **VIDEO FILTER** push button (11) must be in **OFF** position. Set **BANDWIDTH** (10) to 400 kHz. Set the **SCANWIDTH** (15) to 50 MHz/div. After the center frequency is set to 250 MHz, a generator signal must be applied to the input. The output level should be between 40 and 50 dB above the noise.

C: Set generator frequency to **250 MHz**. Adjust the peak of the 250 MHz spectral line to the horizontal screen center using the **X-POS.** control (16).

D: Set the generator frequency to **50 MHz**. If the 50 MHz spectral line is not on the second graticule line from left, it should be aligned using the **X-AMPL.** control (17). Then the calibration as described under **C** should be verified and corrected if necessary.

The calibrations **C** and **D** should be repeated until optimum adjustment is achieved.

Horizontal Calibration (Models 2615A and 2620A)

Prior to calibration ensure that all input attenuators switches (14) are released. The spectrum analyzer must be operated for at least 60 minutes prior to calibration. The **VIDEO FILTER** push button (11) must be in **OFF** position. Set **BAND-**

CALIBRATION

WIDTH (10) to 250 kHz. Set the **SCANWIDTH (15)** to 50 MHz/div. After the center frequency is set to 250 MHz, a generator signal must be applied to the input. The output level should be between 40 and 50 dB above the noise.

C: Set generator frequency to **250 MHz**. Adjust the peak of the 250 MHz spectral line to the horizontal screen center using the **X-POS.** control (**16**).

D: Set the generator frequency to **50 MHz**. If the 50 MHz spectral line is not on the 2nd. graticule line from left, it should be aligned using the **X-AMPL.** control (**17**). Then the calibration as described under C should be verified and corrected if necessary.

The calibrations **C** and **D** should be repeated until optimum adjustment is achieved.

Introduction to Spectrum Analysis

General

The analysis of electrical signals is a fundamental problem for many engineers and scientists. Even if the immediate problem is not electrical, the basic parameters of interest are often changed into electrical signals by means of transducers. The rewards for transforming physical parameters to electrical signals are great, as many instruments are available for the analysis of electrical signals in the time and frequency domains.

The traditional way of observing electrical signals is to view them in the time domain using an oscilloscope. The time domain is used to recover relative timing and phase information which is needed to characterize electric circuit behavior. However, not all circuits can be uniquely characterized from just time domain information. Circuit elements such as amplifiers, oscillators, mixers, modulators, detectors and filters are best characterized by their frequency response information. This frequency information is best obtained by viewing electrical signals in the frequency domain. To display the frequency domain requires a device that can discriminate between frequencies while measuring the power level at each. One instrument which displays the frequency domain is the spectrum analyzer. It graphically displays voltage or power as a function of frequency on a CRT (cathode ray tube).

In the time domain, all frequency components of a signal are seen summed together. In the frequency domain, complex signals (i.e. signals composed of more than one frequency) are separated into their frequency components, and the power level at each frequency is displayed. The frequency domain is a graphical representation of signal amplitude as a function of frequency. The frequency domain contains information not found in the time domain and therefore, the spectrum analyzer has certain advantages compared with an oscilloscope.

The analyzer is more sensitive to low level distortion than a scope. Sine waves may look good in the time domain, but in the frequency domain, harmonic distortion can be seen. The sensitivity and wide dynamic range of the spectrum analyzer is useful for measuring low-level modulation. It can be used to measure AM, FM and pulsed RF. The analyzer can be used to measure carrier frequency, modulation frequency, modulation level, and modulation distortion. Frequency conversion devices can be easily characterized. Such parameters as conversion loss, isolation, and distortion are readily determined from the display.

The spectrum analyzer can be used to measure long and short term stability. Parameters such as noise sidebands on an

oscillator, residual FM of a source and frequency drift during warm-up can be measured using the spectrum analyzers calibrated scans. The swept frequency responses of a filter or amplifier are examples of swept frequency measurements possible with a spectrum analyzer. These measurements are simplified by using a tracking generator.

Types of Spectrum Analyzers

There are two basic types of spectrum analyzers, swept-tuned and real-time analyzers. The swept-tuned analyzers are tuned by electrically sweeping them over their frequency range. Therefore, the frequency components of a spectrum are sampled sequentially in time. This enables periodic and random signals to be displayed, but makes it impossible to display transient responses. Real-time analyzers, on the other hand, simultaneously display the amplitude of all signals in the frequency range of the analyzer; hence the name real-time. This preserves the time dependency between signals which permits phase information to be displayed. Real-time analyzers are capable of displaying transient responses as well as periodic and random signals.

The swept-tuned analyzers are usually of the trf (tuned radio frequency) or superheterodyne type. A trf analyzer consists of a bandpass filter whose center frequency is tunable over a desired frequency range, a detector to produce vertical deflection on a CRT, and a horizontal scan generator used to synchronize the tuned frequency to the CRT horizontal deflection. It is a simple, inexpensive analyzer with wide frequency coverage, but lacks resolution and sensitivity. Because trf analyzers have a swept filter they are limited in sweep width depending on the frequency range (usually one decade or less). The resolution is determined by the filter bandwidth, and since tunable filters do not usually have constant bandwidth, is dependent on frequency.

The most common type of spectrum analyzer differs from the trf spectrum analyzers in that the spectrum is swept through a fixed bandpass filter instead of sweeping the filter through the spectrum. The analyzer is basically a narrowband receiver which is electronically tuned in frequency by applying a saw-tooth voltage to the frequency control element of a voltage tuned local oscillator. This same saw-tooth voltage is simultaneously applied to the horizontal deflection plates of the CRT. The output from the receiver is synchronously applied to the vertical deflection plates of the CRT and a plot of amplitude versus frequency is displayed.

The analyzer is tuned through its frequency range by varying the voltage on the LO (local oscillator). The LO frequency is

mixed with the input signal to produce an IF (intermediate frequency) which can be detected and displayed. When the frequency difference between the input signal and the LO frequency is equal to the IF frequency, then there is a response on the analyzer. The advantages of the superheterodyne technique are considerable. It obtains high sensitivity through the use of IF amplifiers, and many decades in frequency can be tuned.

Also, the resolution can be varied by changing the bandwidth of the IF filters. However, the superheterodyne analyzer is not real-time and sweep rates must be consistent with the IF filter time constant.

A peak at the left edge of the CRT is sometimes called the "zero frequency indicator" or "local oscillator feedthrough". It occurs when the analyzer is tuned to zero frequency, and the local oscillator passes directly through IF creating a peak on the CRT even when no input signal is present. (For zero frequency tuning, $FLO=FIF$). This effectively limits the lower tuning limit.

Spectrum Analyzer Requirements

To accurately display the frequency and amplitude of a signal on a spectrum analyzer, the analyzer itself must be properly calibrated. A spectrum analyzer properly designed for accurate frequency and amplitude measurements has to satisfy many requirements:

1. Wide tuning range
2. Wide frequency display range
3. Stability
4. Resolution
5. Flat frequency response
6. High sensitivity
7. Low internal distortion

Frequency Measurements

The frequency scale can be scanned in three different modes full, per division, and zero scan. The full scan mode is used to locate signals because the widest frequency ranges are displayed in this mode. (Not all spectrum analyzers offer this mode).

The per division mode is used to zoom-in on a particular signal. In per division, the center frequency of the display is set by the Tuning control and the scale factor is set by the Frequency Span or Scan Width control. In the zero scan mode, the analyzer acts as a fixed-tuned receiver with selectable bandwidths.

Absolute frequency measurements are usually made from the spectrum analyzer tuning dial. Relative frequency measurements require a linear frequency scan. By measuring the

relative separation of two signals on the display, the frequency difference can be determined.

It is important that the spectrum analyzer be more stable than the signals being measured. The stability of the analyzer depends on the frequency stability of its local oscillators. Stability is usually characterized as either short term or long term. Residual FM is a measure of the short term stability which is usually specified in Hz peak-to-peak. Short term stability is also characterized by noise sidebands which are a measure of the analyzers spectral purity. Noise sidebands are specified in terms of dB down and Hz away from a carrier in a specific bandwidth. Long term stability is characterized by the frequency drift of the analyzers LOs. Frequency drift is a measure of how much the frequency changes during a specified time (i.e., Hz/min. or Hz/hr).

Resolution

Before the frequency of a signal can be measured on a spectrum analyzer it must first be resolved. Resolving a signal means distinguishing it from its nearest neighbors. The resolution of a spectrum analyzer is determined by its IF bandwidth. The IF bandwidth is usually the 3 dB bandwidth of the IF filter. The ratio of the 60 dB bandwidth (in Hz) to the 3 dB bandwidth (in Hz) is known as the shape factor of the filter. The smaller the shape factor, the greater is the analyzers' capability to resolve closely spaced signals of unequal amplitude. If the shape factor of a filter is 15:1, then two signals whose amplitudes differ by 60 dB must differ in frequency by 7.5 times the IF bandwidth before they can be distinguished separately. Otherwise, they will appear as one signal on the spectrum analyzer display.

The ability of a spectrum analyzer to resolve closely spaced signals of unequal amplitude is not a function of the IF filter shape factor only. Noise sidebands can also reduce the resolution. They appear above the skirt of the IF filter and reduce the offband rejection of the filter. This limits the resolution when measuring signals of unequal amplitude.

The resolution of the spectrum analyzer is limited by its narrowest IF bandwidth. For example, if the narrowest bandwidth is 10 kHz, then the nearest any two signals can be and still be resolved is 10 kHz. This is because the analyzer traces out its own IF band-pass shape as it sweeps through a CW signal. Since the resolution of the analyzer is limited by bandwidth, it seems that by reducing the IF bandwidth infinitely, infinite resolution will be achieved. The fallacy here is that the usable IF bandwidth is limited by the stability (residual FM) of the analyzer. If the internal frequency deviation of the analyzer is 10 kHz, then the narrowest bandwidth that can be used to distinguish a single input signal is 10 kHz. Any narrower IF-filter will result in more than one response or an intermittent response for a single input frequency. A practical limitation exists on the IF bandwidth as well, since narrow

Introduction to Spectrum Analysis

determine that adequate sensitivity exists. For example, 70 dB down from -27 dBm is -97 dB. This is the level we must be able to detect, and the bandwidth required for this sensitivity must not be too narrow or it will be useless. Last, the display range must be adequate.

Notice that the spurious-free measurement range can be extended by reducing the level at the input mixer. The only limitation, then, is sensitivity. To ensure a maximum dynamic range on the CRT display, check to see that the following requirements are satisfied.

1. The largest input signal does not exceed the optimum input level of the analyzer (typically -27 dBm with 0 dB input attenuation).
2. The peak of the largest input signal rests at the top of the CRT display (reference level).

Frequency Response

The frequency response of an analyzer is the amplitude linearity of the analyzer over its frequency range. If a spectrum analyzer is to display equal amplitudes for input signals of equal amplitude, independent of frequency, then the conversion (power) loss of the input mixer must not depend on frequency. If the voltage from the LO is too large compared to the input signal voltage then the conversion loss of the input mixer is frequency dependent and the frequency response of the system is nonlinear. For accurate amplitude measurements, a spectrum analyzer should be as flat as possible over its frequency range.

Flatness is usually the limiting factor in amplitude accuracy since it's extremely difficult to calibrate out. And, since the primary function of the spectrum analyzer is to compare signal levels at different frequencies, a lack of flatness can seriously limit its usefulness.

Tracking Generators

The tracking generator (Models 2620A and 2630 only) is a special signal source whose RF output frequency tracks (follows) some other signal beyond the tracking generator itself. In conjunction with the spectrum analyzer, the tracking generator produces a signal whose frequency precisely tracks the spectrum analyzer tuning. The tracking generator frequency precisely tracks the spectrum analyzer tuning since both are effectively tuned by the same VTO. This precision tracking exists in all analyzer scan modes. Thus, in full scan, the tracking generator output is a start-stop sweep, in zero scan the output is simply a CW signal.

The tracking generator signal is generated by synthesizing and mixing two oscillators. One oscillator is part of the tracking generator itself, the other oscillator is the spectrum analyzer 1st LO. The spectrum analyzer/tracking generator system is used in two configurations: open-loop and closed-loop. In the open-loop configuration, unknown external signals are connected to the spectrum analyzer input and the tracking generator output is connected to a counter. This configuration is used for making selective and sensitive precise measurement of frequency, by tuning to the signal and switching to zero scan.

In the closed-loop configuration, the tracking generator signal is fed into the device under test and the output of the device under test is connected to the analyzer input.

In this configuration, the spectrum-analyzer/tracking-generator becomes a self-contained, complete (source, detector, and display) swept frequency measurement system. An internal leveling loop in the tracking generator ensures a leveled output over the entire frequency range. The specific swept measurements that can be made with this system are frequency response (amplitude vs. frequency), magnitude only reflection coefficient, and return loss. From return loss or reflection coefficient, the SWR can be calculated. Swept phase and group delay measurements cannot be made with this system; however, it does make some unique contributions not made by other swept systems, such as a sweeper/network analyzer, a sweeper/spectrum analyzer, or a sweeper/detector oscilloscope.

Precision tracking means at every instant of time the generator fundamental frequency is in the center of the analyzer passband, and all generator harmonics, whether they are generated in the analyzer or are produced in the tracking generator itself, are outside the analyzer passband. Thus only the tracking generator fundamental frequency is displayed on the analyzer's CRT. Second and third order harmonics and intermodulation products are clearly out of the analyzer tuning and, therefore, they are not seen. Thus, while these distortion products may exist in the measurement set-up, they are completely eliminated from the CRT display.

The 1 dB gain compression level is a point of convenience, but it is nonetheless considered the upper limit of the dynamic range. The lower limit, on the other hand, is dictated by the analyzer sensitivity which, as we know, is bandwidth dependent. The narrowest usable bandwidth in turn is limited by the tracking generator residual FM and any tracking drift between the analyzer tuning and the tracking generator signal.

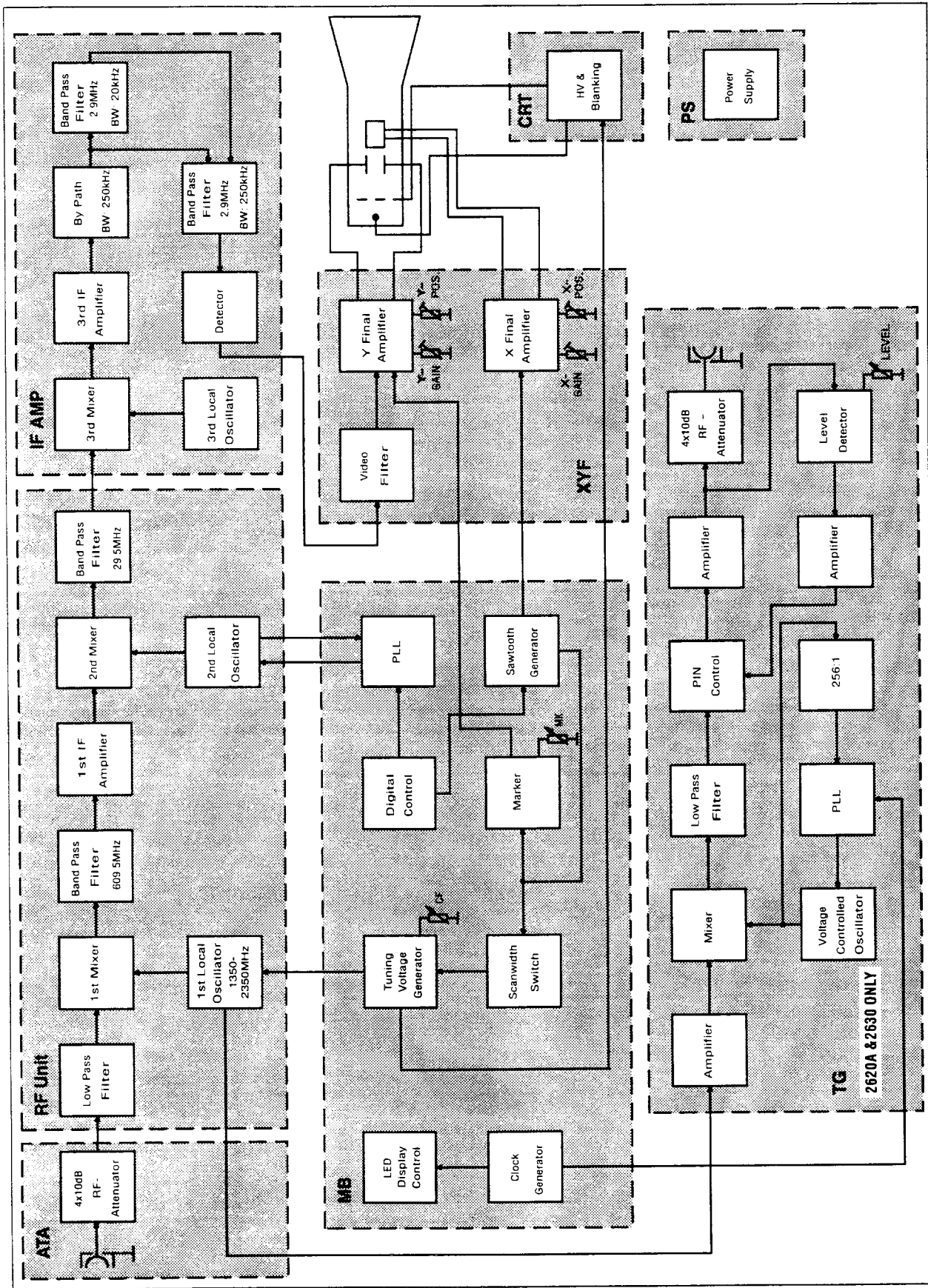

Fig. 7. Block Diagram

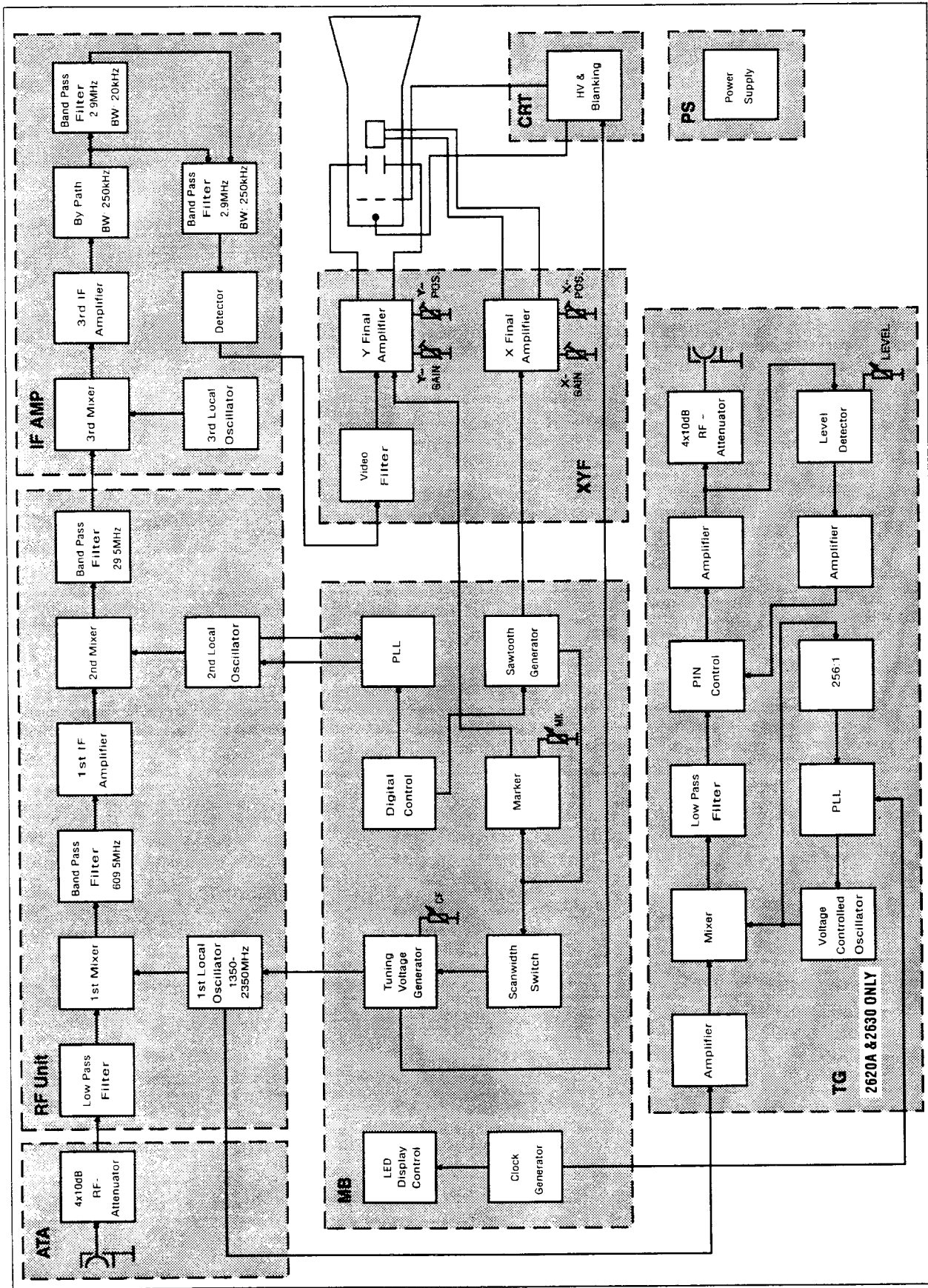

Fig. 7. Block Diagram

APPENDIX — dBm CONVERSION

The most common measurement of RF signal levels is in dBm where 0 dBm equals 1 milliwatt across 50 ohms (224 mV). The Models 2615A, 2620A, 2625, and 2630 read signal level in dBm. Some users measure signal level in dBmV where

0 dB equals 1 millivolt, in dBμV where 0 dB equals 1 microvolt, or directly in millivolts or microvolts. The following table provides conversion from dB to other measurement schemes.

dBm Conversion Chart

dBm	dBmV	dBμV	μV/mV	dBm	dBmV	dBμV	μV/mV	dBm	dBmV	dBμV	μV/mV
+13	+60	+120	1000 mV	-26	+21	+81	11.2 mV	-64	-17	+43	141 μV
+12	+59	+119	891 mV	-27	+20	+80	10.0 mV	-65	-18	+42	126 μV
+11	+58	+118	794 mV	-28	+19	+79	8.91 mV	-66	-19	+41	112 μV
+10	+57	+117	707 mV	-29	+18	+78	7.94 mV	-67	-20	+40	100 μV
+9	+56	+116	631 mV	-30	+17	+77	7079 μV	-68	-21	+39	89.1 μV
+8	+55	+115	562 mV	-31	+16	+76	6310 μV	-69	-22	+38	79.4 μV
+7	+54	+114	501 mV	-32	+15	+75	5623 μV	-70	-23	+37	70.7 μV
+6	+53	+113	447 mV	-33	+14	+74	5012 μV	-71	-24	+36	63.1 μV
+5	+52	+112	398 mV	-34	+13	+73	4467 μV	-72	-25	+35	56.2 μV
+4	+51	+111	355 mV	-35	+12	+72	3981 μV	-73	-26	+34	50.1 μV
+3	+50	+110	316 mV	-36	+11	+71	3548 μV	-74	-27	+33	44.7 μV
+2	+49	+109	282 mV	-37	+10	+70	3162 μV	-75	-28	+32	39.8 μV
+1	+48	+108	251 mV	-38	+9	+69	2818 μV	-76	-29	+31	35.5 μV
0	+47	+107	224 mV	-39	+8	+68	2512 μV	-77	-30	+30	31.6 μV
-1	+46	+106	200 mV	-40	+7	+67	2239 μV	-78	-31	+29	28.2 μV
-2	+45	+105	178 mV	-41	+6	+66	1995 μV	-79	-32	+28	25.1 μV
-3	+44	+104	158 mV	-42	+5	+65	1778 μV	-80	-33	+27	22.4 μV
-4	+43	+103	141 mV	-43	+4	+64	1585 μV	-81	-34	+26	20.0 μV
-5	+42	+102	126 mV	-44	+3	+63	1413 μV	-82	-35	+25	17.8 μV
-6	+41	+101	112 mV	-45	+2	+62	1259 μV	-83	-36	+24	15.8 μV
-7	+40	+100	100 mV	-46	+1	+61	1122 μV	-84	-37	+23	14.1 μV
-8	+39	+99	89.1 mV	-47	0	+60	1000 μV	-85	-38	+22	12.6 μV
-9	+38	+98	79.4 mV	-48	-1	+59	891 μV	-86	-39	+21	11.2 μV
-10	+37	+97	70.7 mV	-49	-2	+58	794 μV	-87	-40	+20	10.0 μV
-11	+36	+96	63.1 mV	-50	-3	+57	707 μV	-88	-41	+19	8.91 μV
-12	+35	+95	56.2 mV	-51	-4	+56	631 μV	-89	-42	+18	7.94 μV
-13	+34	+94	50.1 mV	-52	-5	+55	562 μV	-90	-43	+17	7.07 μV
-14	+33	+93	44.7 mV	-53	-6	+54	501 μV	-91	-44	+16	6.31 μV
-15	+32	+92	39.8 mV	-54	-7	+53	447 μV	-92	-45	+15	5.62 μV
-16	+31	+91	35.5 mV	-55	-8	+52	398 μV	-93	-46	+14	5.01 μV
-17	+30	+90	31.6 mV	-56	-9	+51	355 μV	-94	-47	+13	4.47 μV
-18	+29	+89	28.2 mV	-57	-10	+50	316 μV	-95	-48	+12	3.98 μV
-19	+28	+88	25.1 mV	-58	-11	+49	282 μV	-96	-49	+11	3.55 μV
-20	+27	+87	22.4 mV	-59	-12	+48	251 μV	-97	-50	+10	3.16 μV
-21	+26	+86	20.0 mV	-60	-13	+47	224 μV	-98	-51	+9	2.82 μV
-22	+25	+85	17.8 mV	-61	-14	+46	200 μV	-99	-52	+8	2.51 μV
-23	+24	+84	15.8 mV	-62	-15	+45	178 μV	-100	-53	+7	2.24 μV
-24	+23	+83	14.1 mV	-63	-16	+44	158 μV				
-25	+22	+82	12.6 mV								

CUSTOMER SUPPORT

1-800-462-9832

B+K Precision offers courteous, professional technical support before and after the sale of their test instruments. The following services are typical of those available from our toll-free telephone number:

- Technical advice on the use of your instrument.
- Technical advice on special applications of your instrument.
- Technical advice on selecting the best instrument for a given task.
- Information on optional accessories for your instrument.
- Information on instrument repair and recalibration services.
- Replacement parts ordering.
- Information on other **B+K Precision** instruments.
- Requests for a new **B+K Precision** catalog.
- The name of your nearest **B+K Precision** distributor.

Call toll-free 1-800-462-9832
Monday through Friday, 8:00 A.M. to 5:00 P.M.
Central Standard Time
(Central Daylight Time in summer)

INSTRUMENT REPAIR SERVICE

Because of the specialized skills and test equipment required for instrument repair and calibration, many customers prefer to rely upon **B+K PRECISION** for this service. We maintain a network of **B+K PRECISION** authorized service agencies for this purpose. To use this service, even if the instrument is no longer under warranty, follow the instructions given in the **WARRANTY SERVICE INSTRUCTIONS** portion of this manual. There is a nominal charge for instruments out of warranty.