

# LTC3861EUHE

## High Current, Dual Output Synchronous Buck Converter

### DESCRIPTION

Demonstration circuit 1822A is a dual output synchronous buck converter featuring the LTC<sup>®</sup>3861EUHE. The board provides two outputs of 1.5V/25A and 1.2V/25A from an input voltage of 7V to 14V at a switching frequency of 500kHz. The power stage consists of a 6mm × 6mm DrMOS and a 13mm × 13mm iron powder type inductor. An on-board 5V LT<sup>®</sup>3470 buck regulator provides the 5V bias for the LTC3861 and the DrMOS.

The demo board uses a high density, two sided drop-in layout. The power components, excluding the bulk output and input capacitors, fit within a 1.5" × 1.2" area on the top layer. The control circuit fits in a 1.1" × 1.0" area on the bottom layer. The package style for the LTC3861EUHE is a 36-lead 5mm × 6mm QFN.

LT, LT, LTC, LTM, μModule, Linear Technology and the Linear logo are registered trademarks of Linear Technology Corporation. All other trademarks are the property of their respective owners.

The main features of the board are:

- Remote sensing for each output, where the divider is placed before a high input impedance differential amplifier.
- CLKIN and CLKOUT pins.
- Optional resistors to tie the two outputs together.
- Connector and header to tie two or more boards together for up to 12-phase operation.
- Optional footprint for an LTC4449 gate driver and discrete MOSFETs.
- Optional footprint for a dual phase Delta power block.

**Design files for this circuit board are available at <http://www.linear.com/demo>**

### PERFORMANCE SUMMARY (T<sub>A</sub> = 25°C), no airflow

PARAMETER	CONDITION	VALUE
Minimum Input Voltage		7V
Maximum Input Voltage		14V
Output Voltage V <sub>OUT1</sub>	I <sub>OUT1</sub> = 0A to 25A, V <sub>IN</sub> = 7V to 14V	1.5V ±2%
Output Voltage V <sub>OUT2</sub>	I <sub>OUT2</sub> = 0A to 25A, V <sub>IN</sub> = 7V to 14V	1.2V ±2%
V <sub>OUT1</sub> Maximum Output Current, I <sub>OUT1</sub>	V <sub>IN</sub> = 7V to 14V, V <sub>OUT1</sub> = 1.5V	25A
V <sub>OUT2</sub> Maximum Output Current, I <sub>OUT2</sub>	V <sub>IN</sub> = 7V to 14V, V <sub>OUT2</sub> = 1.2V	25A
Nominal Switching Frequency		500kHz
Efficiency (See Figures 2 and 3)	V <sub>OUT1</sub> = 1.5V, I <sub>OUT1</sub> = 25A, V <sub>IN</sub> = 12V	91.6% Typical
	V <sub>OUT2</sub> = 1.2V, I <sub>OUT2</sub> = 25A, V <sub>IN</sub> = 12V	90.7% Typical

# DEMO MANUAL DC1822A

## QUICK START PROCEDURE

Demonstration circuit 1822A is easy to set up to evaluate the performance of the LTC3861EUHE. Please refer to Figure 1 for proper measurement equipment setup and follow the procedure below.

1. With power off, connect the input supply, load and meters, as shown in Figure 1. Preset the load to 0A and  $V_{IN}$  supply to be 0V. Place jumpers in the following positions:

<b>JP1</b>	<b>RUN1</b>	<b>ON</b>
<b>JP2</b>	<b>RUN2</b>	<b>ON</b>
<b>JP3</b>	<b>INT BIAS</b>	<b>ON</b>

2. Adjust the input voltage to be between 7V to 14V.  $V_{OUT1}$  should be  $1.5V \pm 2\%$ .  $V_{OUT2}$  should be  $1.2V \pm 2\%$ .

- Next, apply 25A load to each output and re-measure  $V_{OUT}$ .
- Once the DC regulation is confirmed, observe the output voltage ripple, load step response, efficiency and other parameters.

NOTE 1. Use the BNC connectors labeled  $V_{OUT1}$  or  $V_{OUT2}$  to measure the output voltage ripple.

NOTE 2. Do not apply the load from the  $V_{OS1+}$  turret to the  $V_{OS1-}$  turret or from the  $V_{OS2+}$  turret to the  $V_{OS2-}$  turret. These are connected to the sense traces for the output voltage. Heavy load currents applied across these turrets may damage these traces.

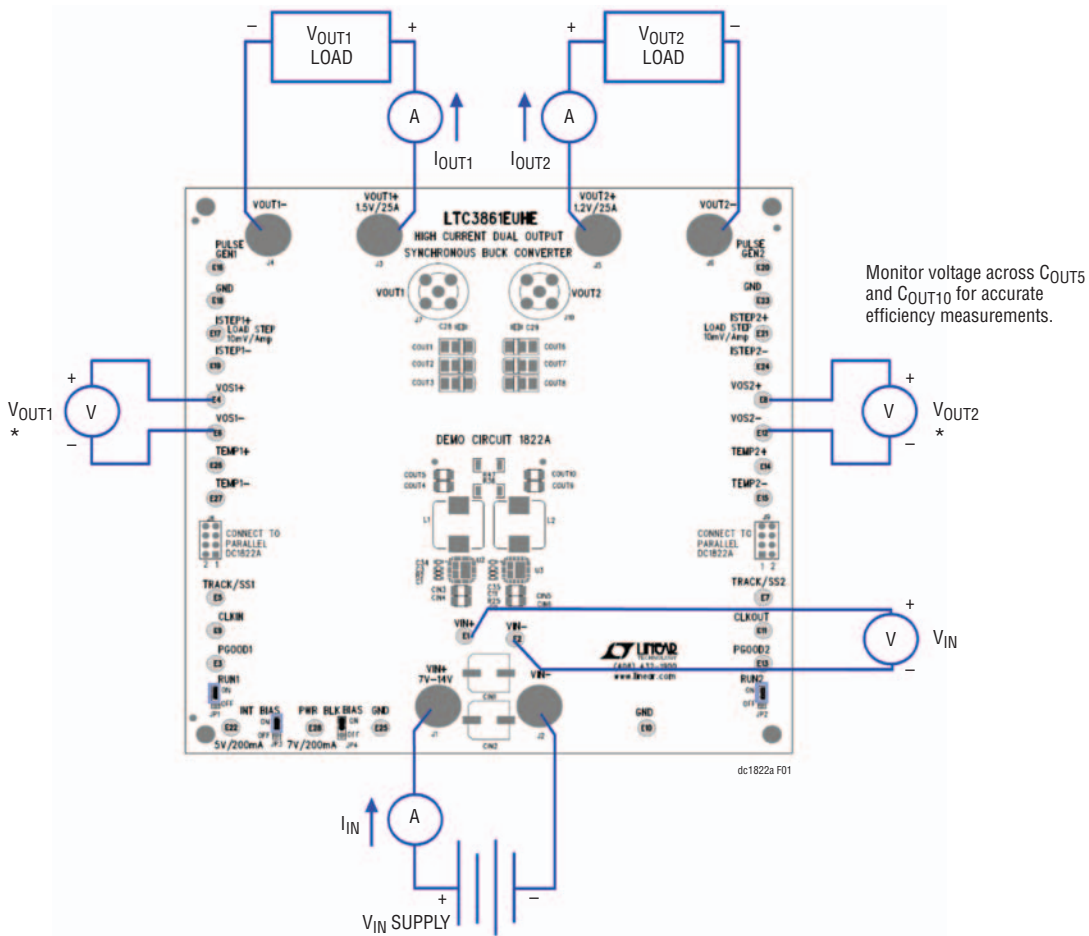
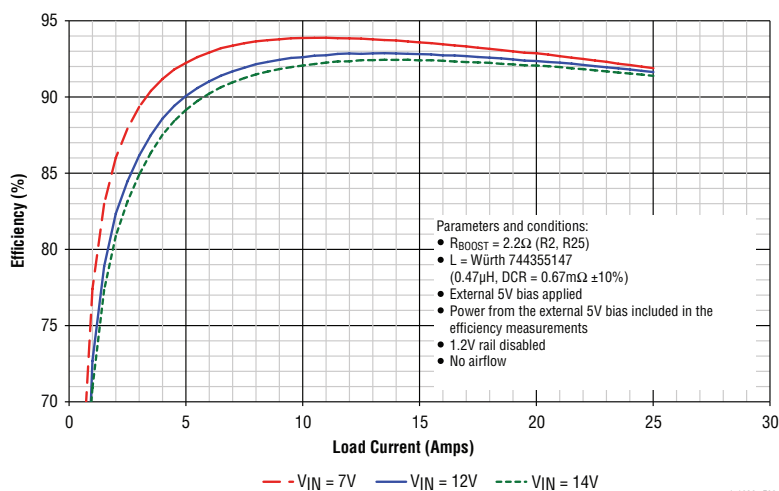


Figure 1. Proper Measurement Equipment Setup

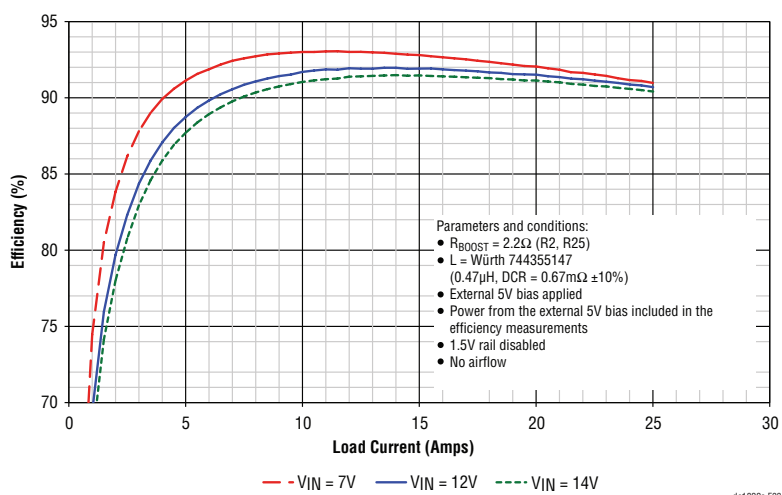
## QUICK START PROCEDURE

### DYNAMIC LOAD CIRCUIT (OPTIONAL)

1. Preset the amplitude of a pulse generator to 0.0V and the duty cycle to 5% or less.
2. Connect the scope to the VOUT BNC connectors for the rail under test with a coax cable. To monitor the load step current, connect the scope probe across the ISTEP± turrets for that rail.
3. Connect the output of the pulse generator to the PULSE GEN turret for the rail under test and connect the return to one of the GND turrets.
4. With the converter running, slowly increase the amplitude of the pulse generator output to provide the desired load step pulse height. The scaling for the load step signal is 10mV/Amp. See Figures 4 and 5 for transient response curves with a 50% load change.

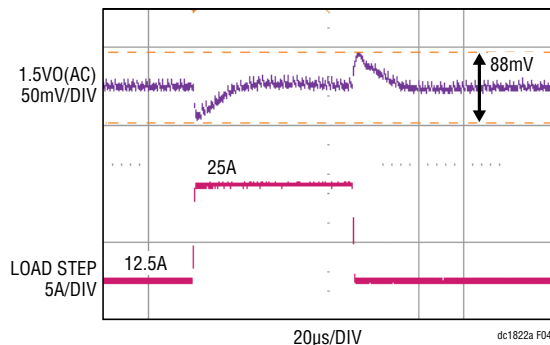


**Figure 2. Efficiency Curves for the 1.5V Rail of the DC1822A.**  
 $f_{sw} = 500\text{kHz}$  with the FDMF6820A DrMOS

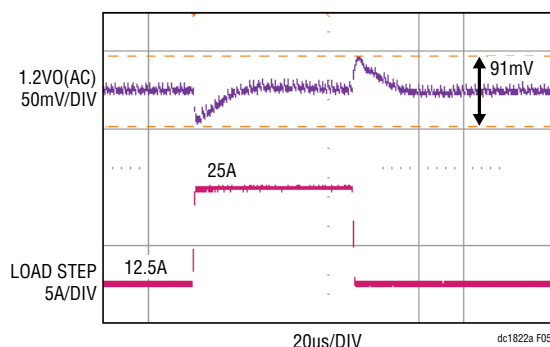


**Figure 3. Efficiency Curves for the 1.2V Rail of the DC1822A.**  
 $f_{sw} = 500\text{kHz}$  with the FDMF6820A DrMOS

## QUICK START PROCEDURE



**Figure 4. Load Step Response of the DC1822A 1.5V Rail at  $V_{IN} = 12V$ .  
 $C_{OUT} = 3 \times$  Sanyo 2R5TPE330M9 ||  $2 \times 100\mu F$  X5R 6.3V 1210,  $L = 0.47\mu H$ ,  
 $f_{SW} = 500kHz$**



**Figure 5. Load Step Response of the DC1822A 1.2V Rail at  $V_{IN} = 12V$ .  
 $C_{OUT} = 3 \times$  Sanyo 2R5TPE330M9 ||  $2 \times 100\mu F$  X5R 6.3V 1210,  $L = 0.47\mu H$ ,  
 $f_{SW} = 500kHz$**

### SINGLE OUTPUT/DUAL PHASE OPERATION

A single output/dual phase converter may be preferred for higher output current applications. The optional components required to tie the phases together are found on the bottom of the schematic shown in Figure 8. To tie the two outputs together, make the following modifications:

1. Stuff  $0\Omega$  at R36 and R47 to tie the two outputs together.
2. Select one rail to be the master.
  - If VOUT1 is the master, then stuff  $0\Omega$  at R51 to disable the error amplifier for phase 2. Also stuff  $0\Omega$  at R52.
  - If VOUT2 is the master, then stuff  $0\Omega$  at R49 to disable the error amplifier for phase 1. Also stuff  $0\Omega$  at R50.
3. Remove the  $0\Omega$  jumper at R13 and stuff a  $100pF$  capacitor at C14 for the IAVG signal.

4. Stuff  $0\Omega$  at R53, R48 and R54 to tie the COMP, TRK/SS and RUN pins together.

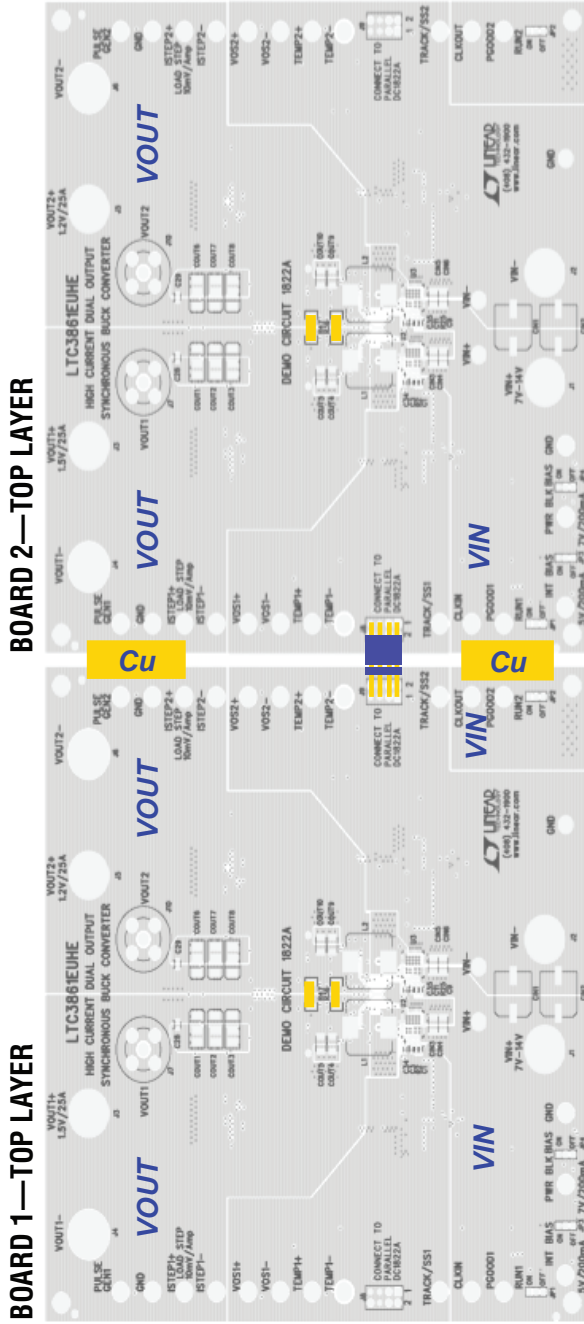
5. Remove the redundant compensation components.

### PARALLELING BOARDS

The DC1822A demo boards can be tied together to form a converter with up to 12 phases. To tie the boards together, place the boards side-by-side and then connect the boards by connecting J8 of one board to J9 of the other. This will connect the IAVG, COMP, TRK/SS and signal ground signals together. Next, use copper strips to tie the VOUT planes, the VIN planes and GND planes of the two adjacent boards together. The board has exposed copper along the edges of the board for this purpose. Figure 6 shows how to set up a 4-phase converter and Figure 7 shows how to set up a 3-phase plus single phase converter.

dc1822af

QUICK START PROCEDURE



Note: Tie GND shapes together on the bottom layer by using the exposed copper along the edge of the board.

	VOUT1 TO VOUT2 R36 & R47	ILIM1 TO VCC R50	ILIM1 R R17	ILIM2 TO VCC R52	ILIM2 R R24	FB1 TO VCC R49	FB2 TO VCC R51	TRK/SS1 TO TRK/SS2 R48	COMP1 TO COMP2 R53	RUN1 TO RUN2 R54	PHASE MODE SETTING R41	I AVG PIN C14
BOARD #1	0.0mΩ	NS	STUFF	0Ω	NS	0Ω	0Ω	0Ω	0Ω	0Ω	NS	100pF
BOARD #2	0.0mΩ	NS	STUFF	0Ω	NS	0Ω	0Ω	0Ω	0Ω	0Ω	NS	100pF

dc1822a f06

Figure 6. Setup of a 4-Phase Converter; Phase 1 of Board 1 is the Master



## PARTS LIST

ITEM	QTY	REFERENCE	PART DESCRIPTION	MANUFACTURER/PART NUMBER
<b>DC1822A Required Circuit Components</b>				
1	4	C1, C7, C8, C9	CAP, 0.22µF, 10%, 25V, X7R, 0603	AVX 06033C224KAT2A
2	2	C1-1, C1-2	CAP, 1500pF, 10%, 50V, GOG, 0603	MURATA,GRM1885C1H152JA01D
3	2	C2-1, C2-2	CAP, 100pF, 5%, 25V, NPO, 0603	AVX 06033A101JAT2A
4	2	C28, C29	CAP, 10µF, 20%, 6.3V, X5R, 0805	AVX 08056D106MAT2A
5	4	C3, C11, C34, C35	CAP, 2.2µF, 10%, 16V, X7R, 0603	MURATA GRM188R61C225KE15D
6	2	C3-1, C3-2	CAP, 3300pF, 10%, 50V X7R, 0603	AVX 06035C332KAT2A
7	1	C6	CAP, 1µF, 20%, 25V, X5R, 0603	AVX 06033D105MAT2A
8	1	CIN2	CAP, 180µF, 20%, 16V, OSCON	SANYO 16SVP180MX
9	4	CIN3, CIN4, CIN5, CIN6	CAP, 22µF, 20%, 16V, X5R, 1210	AVX 1210YD226MAT2A
10	6	COU1-COU3, COU6-COU8	CAP, 330µF, 20%, 2.5V POSCAP 7343	SANYO 2R5TPE330M9
11	4	COU4, COU5, COU9, COU10	CAP, 100µF, 20%, 6.3V, X5R, 1210	AVX 12106D107MAT2A
12	2	L1,L2	IND, 0.47µH, 20%	WURTH 744355147
13	2	R1, R45	RES, 18.2k, 1%, 1/10W, 0603	VISHAY CRCW060318K2FKEA
14	4	R11, R18, R39, R43	RES, 10Ω, 1%, 1/10W, 0603	VISHAY CRCW060310R0FKEA
15	2	R17, R24	RES, 53.6k, 1%, 1/10W, 0603	VISHAY CRCW060353K6FKEA
16	2	R2, R25	RES, 2.2Ω, 1%, 1/16W, 0603	VISHAY CRCW06032R20FKEA
17	2	R20, R38	RES, 2.87k, 1%, 1/10W, 0603	VISHAY CRCW06032K87FKEA
18	1	R2-1	RES, 9.76k, 1%, 1/16W, 0603	VISHAY CRCW06039K76FKEA
19	1	R2-2	RES, 9.31k, 1%, 1/16W, 0603	VISHAY CRCW06039K31FKEA
20	3	R3, R16, R26	RES, 1Ω, 1%, 1/10W, 0603	YAGEO RC0603FR-071RL
21	2	R3-1, R3-2	RES, 280Ω, 1%, 1/10W, 0603	VISHAY CRCW0603280R0FKEA
22	1	R37	RES, 34k, 1%, 1/10W, 0603	VISHAY CRCW060334K0FKEA
23	2	R8, R44	RES, 100k, 1%, 1/10W, 0603	VISHAY CRCW0603100KFKEA
24	9	R9, R12, R13, R19, R21-R23, R32, R73	RES, 0Ω, JUMPER, 0603	VISHAY CRCW06030000Z0EA
25	11	RB-1, RB-2, RT-2, R1-1, R1-2, R4-R6, R29, R30, R46	RES, 10k, 1%, 1/10W, 0603	VISHAY CRCW060310K0FKEA
26	1	RT-1	RES, 15k, 1%, 1/10W, 0603	YAGEO RC0603FR-0715KL
27	1	U1	I.C., LTC3861EUHE	LINEAR TECH. LTC3861EUHE#PBF
28	2	U2, U3	MOSFET, DrMOS, DC-DC, 3.3V, PWM	FAIRCHILD FDMF6820A
<b>Additional Circuit Components</b>				
1	1	C17	CAP, 0.22µF, 10%, 25V, X7R, 0603	AVX 06033C224KAT2A
2	1	C18	CAP, 1µF, 20%, 25V, X5R, 0603	AVX 06033D105MAT2A
3	1	C19	CAP, 22µF, 20%, 16V, X5R, 1210	AVX 1210YD226MAT2A
4	2	C2, C4, C5, C10, C12-C16, C20, C22-C25, C27, C30-C33	CAP, 0603	OPT
5	1	C21	CAP, 22pF, 10%, 25V, NPO, 0603	AVX 06033A220KAT2A
6	1	C26	CAP, 1µF, 20%, 25V, X5R, 0603	AVX 06033D105MAT2A
7	0	CIN1	CAP, SVP, F8	OPT
8	0	CIN7-CIN14, COU11-COU17	CAP, 1210	OPT
9	0	COU15-COU17, COU22-COU24	CAP, 7343	OPT
10	0	D1	DIODE, BAV170, SOT23	OPT



# DEMO MANUAL DC1822A

## PARTS LIST

ITEM	QTY	REFERENCE	PART DESCRIPTION	MANUFACTURER/PART NUMBER
11	0	D2, D3	CMDSH-3	OPT
12	1	L3	IND, 33 $\mu$ H, -53DLC	TOKO A914BYW-330M=P3
13	0	L4	INDUCTOR, -53LDC	OPT
14	0	PB1	DC/DC Converters, D12S1R845A	OPT
15	2	Q1, Q2	MOSFET, 30V N-CHANNEL, DPAK	VISHAY SUD50N03-12P-E3
16	0	Q3, Q4, Q7, Q8	BSC050NE2LS	OPT
17	0	Q5, Q6, Q9, Q10	BSC010NE2LS	OPT
18	0	R10, R14, R15, R27, R28, R31, R33-R35, R41, R42, R47-R55, R62, R64-R67, R69, R71, R72, R74-R81	RES, 0603	OPT
19	2	R56, R58	RES, 10k, 1%, 1/10W, 0603	VISHAY CRCW060310K0FKEA
20	2	R57, R60	RES, 0.010 $\Omega$ , 1%, 1W, 2010	IRC LRC-LRF2010LF-01-R010-F
21	1	R59	RES, 0 $\Omega$ , JUMPER, 1206	VISHAY CRCW12060000Z0EA
22	1	R61	RES, 604k, 1%, 1/16W, 0603	VISHAY CRCW0603604KFKEA
23	1	R63	RES, 200k, 1%, 1/16W, 0603	VISHAY CRCW0603200KFKEA
24	1	U4	BUCK REGULATOR, LT3470ETS8	LINEAR TECHNOLOGY LT3470ETS8
25	0	U5	BUCK REGULATOR, LT3470ETS8	OPT
26	0	U8, U9	N-CHANNEL MOSFET DRIVER, LTC4449	OPT

### Hardware

1	27	E1-E27	TESTPOINT, TURRET, 0.095"	MILL-MAX 2501-2-00-80-00-00-07-0
2	6	J1-J6	STUD, TEST PIN	PEM KFH-032-10
3	12	J1-J6	NUT, BRASS PL #10-32	ANY #10-32M/S
4	6	J1-J6	RING, LUG #10	KEYSTONE 8205
5	6	J1-J6	WASHER, TIN, PLATED BRASS	ANY
6	2	J7, J10	CON, BNC, 5 PINS	CONNEX 112404
7	1	J8	HEADER, DOBL ROW, RT ANGLE, 2x4, 8 PIN	MILL-MAX 802-10-008-20-001000
8	1	J9	SOCKET, DBL ROW, RT ANGLE, 2x4, 8 PIN	MILL-MAX 803-43-008-20-001000
9	4	JP1, JP2, JP3, JP4	HEADER, 3 PIN, 0.079" SINGLE ROW	SAMTEC TMM-103-02-L-S
10	4	MTGS AT 4 CORNERS	STAND-OFF, NYLON 0.5"	KEYSTONE 8833 (SNAP-ON)
11	4	XJP1, XJP2, XJP3, XJP4	SHUNT, 0.079" CENTER	SAMTEC 2SN-BK-G





## SCHEMATIC DIAGRAM

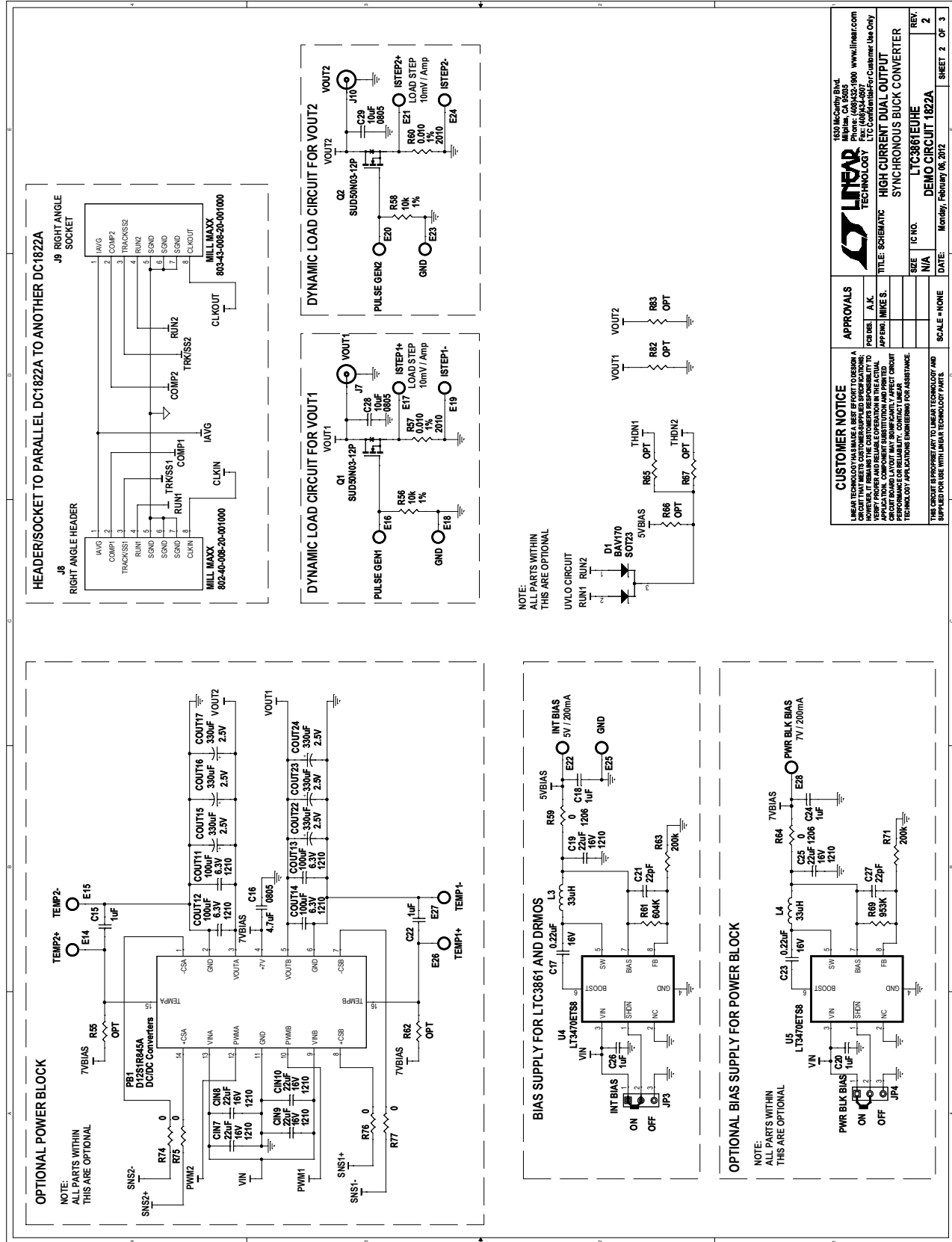


Figure 9. DC1822A Demo Circuit Schematic

## SCHEMATIC DIAGRAM

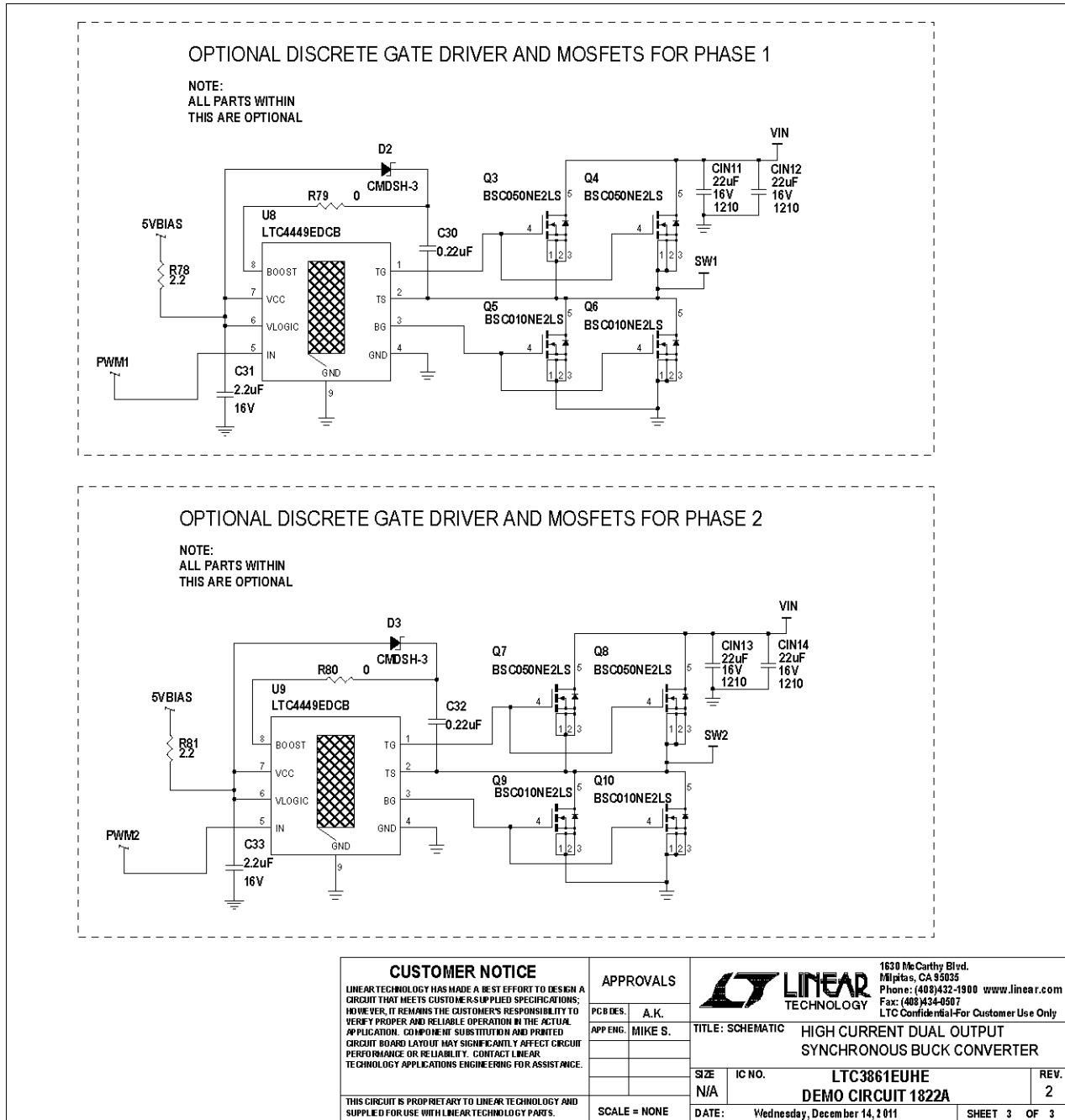


Figure 10. DC1822A Demo Circuit Schematic

# DEMO MANUAL DC1822A

---

## DEMONSTRATION BOARD IMPORTANT NOTICE

Linear Technology Corporation (LTC) provides the enclosed product(s) under the following **AS IS** conditions:

This demonstration board (DEMO BOARD) kit being sold or provided by Linear Technology is intended for use for **ENGINEERING DEVELOPMENT OR EVALUATION PURPOSES ONLY** and is not provided by LTC for commercial use. As such, the DEMO BOARD herein may not be complete in terms of required design-, marketing-, and/or manufacturing-related protective considerations, including but not limited to product safety measures typically found in finished commercial goods. As a prototype, this product does not fall within the scope of the European Union directive on electromagnetic compatibility and therefore may or may not meet the technical requirements of the directive, or other regulations.

If this evaluation kit does not meet the specifications recited in the DEMO BOARD manual the kit may be returned within 30 days from the date of delivery for a full refund. **THE FOREGOING WARRANTY IS THE EXCLUSIVE WARRANTY MADE BY THE SELLER TO BUYER AND IS IN LIEU OF ALL OTHER WARRANTIES, EXPRESSED, IMPLIED, OR STATUTORY, INCLUDING ANY WARRANTY OF MERCHANTABILITY OR FITNESS FOR ANY PARTICULAR PURPOSE. EXCEPT TO THE EXTENT OF THIS INDEMNITY, NEITHER PARTY SHALL BE LIABLE TO THE OTHER FOR ANY INDIRECT, SPECIAL, INCIDENTAL, OR CONSEQUENTIAL DAMAGES.**

The user assumes all responsibility and liability for proper and safe handling of the goods. Further, the user releases LTC from all claims arising from the handling or use of the goods. Due to the open construction of the product, it is the user's responsibility to take any and all appropriate precautions with regard to electrostatic discharge. Also be aware that the products herein may not be regulatory compliant or agency certified (FCC, UL, CE, etc.).

No License is granted under any patent right or other intellectual property whatsoever. **LTC assumes no liability for applications assistance, customer product design, software performance, or infringement of patents or any other intellectual property rights of any kind.**

LTC currently services a variety of customers for products around the world, and therefore this transaction **is not exclusive**.

**Please read the DEMO BOARD manual prior to handling the product.** Persons handling this product must have electronics training and observe good laboratory practice standards. **Common sense is encouraged.**

This notice contains important safety information about temperatures and voltages. For further safety concerns, please contact a LTC application engineer.

Mailing Address:

Linear Technology  
1630 McCarthy Blvd.  
Milpitas, CA 95035

Copyright © 2004, Linear Technology Corporation