



# HL18-B4B3BH

SureSense

CYLINDRICAL PHOTOELECTRIC SENSORS

**SICK**  
Sensor Intelligence.



Illustration may differ



## Ordering information

Type	Part no.
HL18-B4B3BH	1077132

Other models and accessories → [www.sick.com/SureSense](http://www.sick.com/SureSense)

## Detailed technical data

### Features

<b>Sensor/ detection principle</b>	Photoelectric retro-reflective sensor, Dual lens
<b>Dimensions (W x H x D)</b>	16.2 mm x 48.5 mm x 31.8 mm
<b>Housing design (light emission)</b>	Hybrid
<b>Thread diameter (housing)</b>	M18
<b>Sensing range max.</b>	0.03 m ... 6.5 m <sup>1)</sup>
<b>Sensing range</b>	0.03 m ... 5 m <sup>1)</sup>
<b>Type of light</b>	Visible red light
<b>Light source</b>	PinPoint LED <sup>2)</sup>
<b>Light spot size (distance)</b>	130 mm x 260 mm (6.5 m)
<b>Wave length</b>	631 nm
<b>Adjustment</b>	Potentiometer (Sensing range) Potentiometer (light/dark switching)
<b>Special features</b>	Signal strength light bar

<sup>1)</sup> Reflector PL80A.

<sup>2)</sup> Average service life: 100,000 h at T<sub>U</sub> = +25 °C.

## Mechanics/electronics

<b>Supply voltage</b>	10 V DC ... 30 V DC <sup>1)</sup>
<b>Ripple</b>	< 5 V <sub>pp</sub> <sup>2)</sup>
<b>Power consumption</b>	20 mA <sup>3)</sup>
<b>Switching output</b>	PNP, NPN <sup>4)</sup>
<b>Switching mode</b>	Light switching <sup>4)</sup>
<b>Output current I<sub>max.</sub></b>	≤ 100 mA
<b>Response time</b>	≤ 0.5 ms <sup>5)</sup>
<b>Switching frequency</b>	1,000 Hz <sup>6)</sup>
<b>Connection type</b>	Cable with M12 male connector, 4-pin, 150 mm <sup>7)</sup>
<b>Cable material</b>	PVC
<b>Circuit protection</b>	A <sup>8)</sup> B <sup>9)</sup> D <sup>10)</sup>
<b>Protection class</b>	III
<b>Weight</b>	18 g
<b>Polarisation filter</b>	✓
<b>Housing material</b>	Plastic, VISTAL®
<b>Optics material</b>	Plastic, PMMA
<b>Enclosure rating</b>	IP67 IP69K
<b>EMC</b>	EN 60947-5-2 <sup>11)</sup>
<b>Ambient operating temperature</b>	-40 °C ... +70 °C
<b>Ambient storage temperature</b>	-40 °C ... +75 °C
<b>UL File No.</b>	E189383

<sup>1)</sup> Limit values when operated in short-circuit protected network: max. 8 A.

<sup>2)</sup> May not exceed or fall below U<sub>v</sub> tolerances.

<sup>3)</sup> Without signal strength light bar and load.

<sup>4)</sup> Q1 = PNP; Q2 = NPN.

<sup>5)</sup> Signal transit time with resistive load.

<sup>6)</sup> With light/dark ratio 1:1.

<sup>7)</sup> Do not bend below 0 °C.

<sup>8)</sup> A = V<sub>S</sub> connections reverse-polarity protected.

<sup>9)</sup> B = inputs and output reverse-polarity protected.

<sup>10)</sup> D = outputs overcurrent and short-circuit protected.

<sup>11)</sup> The sensor complies with the Radio Safety Requirements (EMC) for the industrial sector (Radio Safety Class A). It may cause radio interference if used in a residential area.

## Classifications

<b>ECl@ss 5.0</b>	27270902
<b>ECl@ss 5.1.4</b>	27270902
<b>ECl@ss 6.0</b>	27270902
<b>ECl@ss 6.2</b>	27270902
<b>ECl@ss 7.0</b>	27270902
<b>ECl@ss 8.0</b>	27270902

<b>ECI@ss 8.1</b>	27270902
<b>ECI@ss 9.0</b>	27270902
<b>ETIM 5.0</b>	EC002717
<b>ETIM 6.0</b>	EC002717
<b>UNSPSC 16.0901</b>	39121528

## Connection diagram

Cd-243

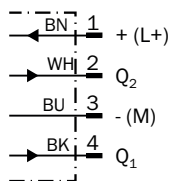

## Characteristic curve

Operating reserve

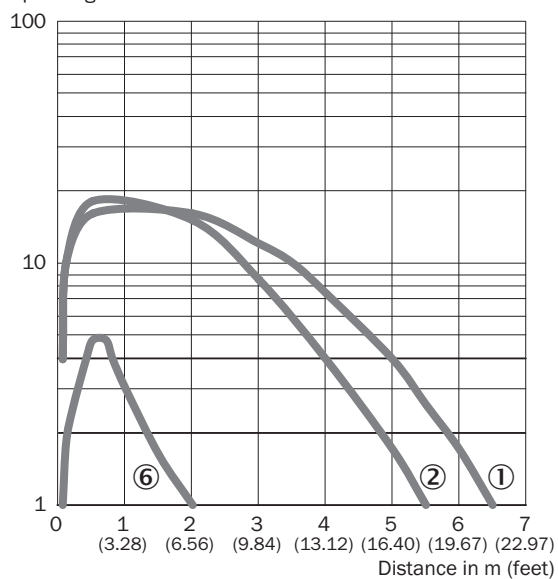

- ① Reflector PL80A
- ② Reflector PL40A
- ⑥ Reflective tape IREF6000 (REF-IRF-56)

## Light spot size

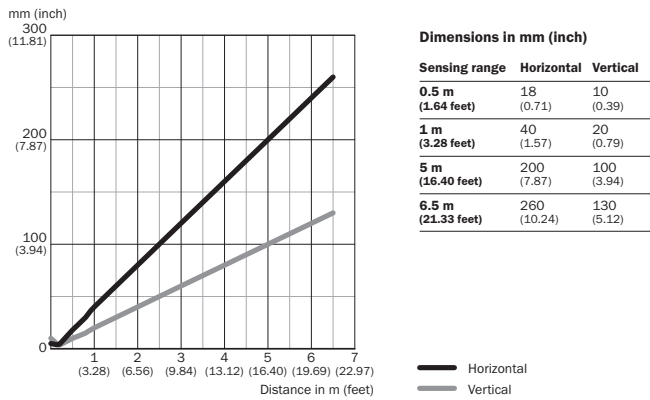

## Sensing range diagram

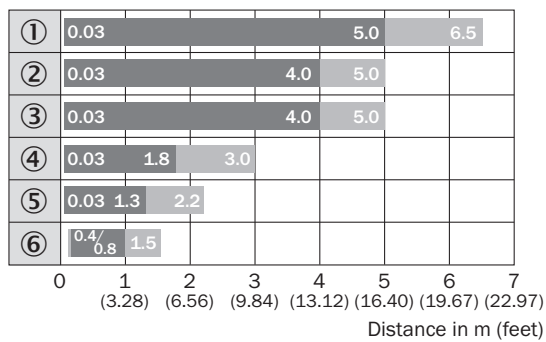

- ① Reflector PL80A
- ② Reflector PL40A
- ③ Reflector P250
- ④ Reflector PL30A, PL31A
- ⑤ Reflector PL20A
- ⑥ Reflective tape IREF6000 (REF-IRF-56)

## Functions

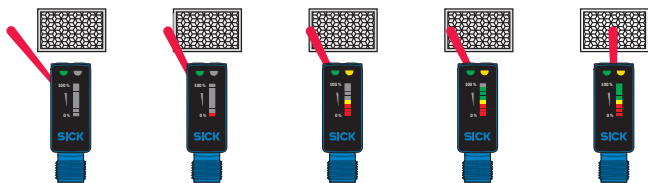

## Dimensional drawing (Dimensions in mm (inch))

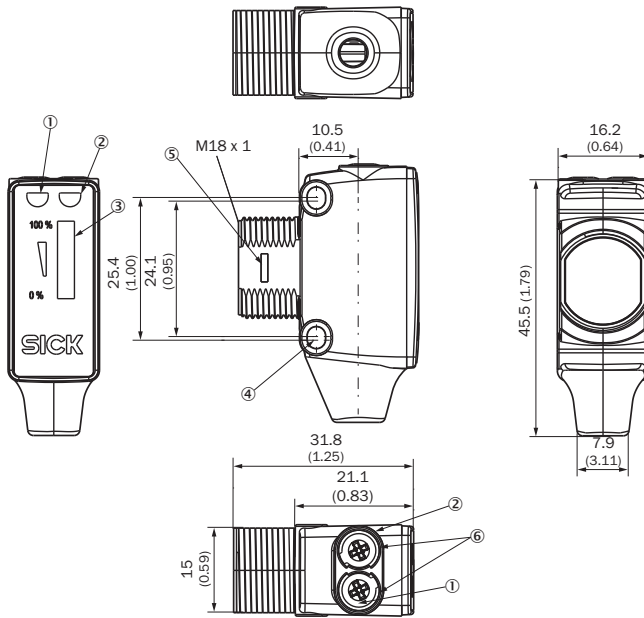

H18, DC, cable



- ① LED indicator green: power on
- ② LED indicator yellow: Status of received light beam
- ③ Signal strength light bar
- ④ M3 mounting hole
- ⑤ Snap Connection for flush ring (sold separately)
- ⑥ Potentiometer (if selected) or LED Indicators

## Recommended accessories









Other models and accessories → [www.sick.com/SureSense](http://www.sick.com/SureSense)

	Brief description	Type	Part no.
<b>Mounting brackets and plates</b>			
	Mounting plate for M18 sensors, steel, zinc coated, without mounting hardware	BEF-WG-M18	5321870
	Mounting bracket for M18 sensors, steel, zinc coated, without mounting hardware	BEF-WN-M18	5308446
	Bottom M18 mounting bracket SureSense sensors	MB-M18-H18	2085820
<b>Other mounting accessories</b>			
	Spherical bearing M18	Ball holder	4057409
	Mounting bracket	MB-BS18MM-M4	2049694

<sup>1)</sup> Customizable length by roll. Width 5 cm, length max. 22.8 m.

	Brief description	Type	Part no.
<b>Terminal and alignment brackets</b>			
	Clamping block for round sensors M18, without fixed stop, plastic (PA12), glass-fiber reinforced, mounting hardware included	BEF-KH-M18	2051481
<b>Plug connectors and cables</b>			
	Head A: female connector, M12, 4-pin, straight Head B: Flying leads Cable: PVC, unshielded, 2 m This product is generally resistant to chemical cleaning agents (see ECOLAB). Please do not use cleaning agents of any other Kind., Not resistant against lactic acid & hydrogen peroxide (H2O2)	DOL-1204-G02MNI	6052613
	Head A: female connector, M12, 4-pin, straight Head B: Flying leads Cable: PVC, unshielded, 5 m This product is generally resistant to chemical cleaning agents (see ECOLAB). Please do not use cleaning agents of any other Kind., Not resistant against lactic acid & hydrogen peroxide (H2O2)	DOL-1204-G05MNI	6052615
	Head A: female connector, M12, 4-pin, angled Head B: Flying leads Cable: PVC, unshielded, 2 m This product is generally resistant to chemical cleaning agents (see ECOLAB). Please do not use cleaning agents of any other Kind., Not resistant against lactic acid & hydrogen peroxide (H2O2)	DOL-1204-W02MNI	6052614
	Head A: female connector, M12, 4-pin, angled Head B: Flying leads Cable: PVC, unshielded, 5 m This product is generally resistant to chemical cleaning agents (see ECOLAB). Please do not use cleaning agents of any other Kind., Not resistant against lactic acid & hydrogen peroxide (H2O2)	DOL-1204-W05MNI	6052616
	Head A: female connector, M12, 4-pin, straight, A-coded Head B: Flying leads Cable: Sensor/actuator cable, PVC, unshielded, 2 m	YF2A14-020VB3XLEAX	2096234
	Head A: female connector, M12, 4-pin, straight, A-coded Head B: Flying leads Cable: Sensor/actuator cable, PVC, unshielded, 5 m	YF2A14-050VB3XLEAX	2096235
	Head A: female connector, M12, 4-pin, angled, A-coded Head B: Flying leads Cable: Sensor/actuator cable, PVC, unshielded, 2 m	YG2A14-020VB3XLEAX	2095895
	Head A: female connector, M12, 4-pin, angled, A-coded Head B: Flying leads Cable: Sensor/actuator cable, PVC, unshielded, 5 m	YG2A14-050VB3XLEAX	2095897
<b>Reflectors</b>			
	Rectangular, screw connection, 47 mm x 47 mm, PMMA/ABS, Screw-on, 2 hole mounting	P250	5304812
	Rectangular, screw connection, 38 mm x 15 mm, PMMA/ABS, Screw-on, 2 hole mounting	PL20A	1012719
	Rectangular, self-adhesive, 38 mm x 15 mm, PMMA/ABS, self-adhesive	PL21A	1015172

1) Customizable length by roll. Width 5 cm, length max. 22.8 m.

	<b>Brief description</b>	<b>Type</b>	<b>Part no.</b>
	Rectangular, screw connection, 56 mm x 28 mm, PMMA/ABS, Screw-on, 2 hole mounting	PL30A	1002314
	Rectangular, screw connection, 37 mm x 56 mm, PMMA/ABS, Screw-on, 2 hole mounting	PL40A	1012720
	Rectangular, screw connection, 80 mm x 80 mm, PMMA/ABS, Screw-on, 2 hole mounting	PL80A	1003865
	Self-adhesive	REF-IRF-56	5314244
	Self-adhesive, customizable length by roll, 5 cm x 22.8 m <sup>1)</sup> , self-adhesive	REF-PLUS-50-K	4051185
	Self-adhesive, roll, 50 mm x 22.8 m, self-adhesive	REF-PLUS-R50	5319981
	Round, screw connection, PMMA/ABS, Center hole mounting, screw-on	C110A	5304549
	Round, self-adhesive, PMMA/ABS, self-adhesive	PL22-2	1003621

<sup>1)</sup> Customizable length by roll. Width 5 cm, length max. 22.8 m.



## SICK AT A GLANCE

SICK is one of the leading manufacturers of intelligent sensors and sensor solutions for industrial applications. A unique range of products and services creates the perfect basis for controlling processes securely and efficiently, protecting individuals from accidents and preventing damage to the environment.

We have extensive experience in a wide range of industries and understand their processes and requirements. With intelligent sensors, we can deliver exactly what our customers need. In application centers in Europe, Asia and North America, system solutions are tested and optimized in accordance with customer specifications. All this makes us a reliable supplier and development partner.

Comprehensive services complete our offering: SICK LifeTime Services provide support throughout the machine life cycle and ensure safety and productivity.

For us, that is “Sensor Intelligence.”

## WORLDWIDE PRESENCE:

Contacts and other locations –[www.sick.com](http://www.sick.com)