

**NPN Silicon Digital Transistor**

- Switching in circuit, inverter, interface circuit, drive circuit
- Built in bias resistor ( $R_1 = 10\text{ k}\Omega$ ,  $R_2 = 10\text{ k}\Omega$ )
- BCR133S: Two internally isolated transistors with good matching in one multichip package



**BCR133/F/L3  
BCR133T/W**

**BCR133S**

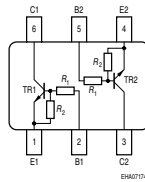
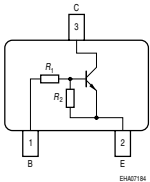

Type	Marking	Pin Configuration						Package
BCR133	WCs	1=B	2=E	3=C	-	-	-	SOT23
BCR133F	WCs	1=B	2=E	3=C	-	-	-	TSFP-3
BCR133L3	WC	1=B	2=E	3=C	-	-	-	TSLP-3-4
BCR133S	WCs	1=E1	2=B1	3=C2	4=E2	5=B2	6=C1	SOT363
BCR133T	WCs	1=B	2=E	3=C	-	-	-	SC75
BCR133W	WCs	1=B	2=E	3=C	-	-	-	SOT323

**Maximum Ratings**

Parameter	Symbol	Value	Unit
Collector-emitter voltage	$V_{CEO}$	50	V
Collector-base voltage	$V_{CBO}$	50	
Emitter-base voltage	$V_{EBO}$	10	
Input on voltage	$V_{i(on)}$	20	
Collector current	$I_C$	100	mA
Total power dissipation- BCR133, $T_S \leq 102^\circ\text{C}$ BCR133F, $T_S \leq 128^\circ\text{C}$ BCR133L3, $T_S \leq 135^\circ\text{C}$ BCR133S, $T_S \leq 115^\circ\text{C}$ BCR133T, $T_S \leq 109^\circ\text{C}$ BCR133W, $T_S \leq 124^\circ\text{C}$	$P_{tot}$	200 250 250 250 250 250	mW
Junction temperature	$T_j$	150	$^\circ\text{C}$
Storage temperature	$T_{stg}$	-65 ... 150	

**Thermal Resistance**

Parameter	Symbol	Value	Unit
Junction - soldering point <sup>1)</sup>	$R_{thJS}$		K/W
BCR133		$\leq 240$	
BCR133F		$\leq 90$	
BCR133L3		$\leq 60$	
BCR133S		$\leq 140$	
BCR133T		$\leq 165$	
BCR133W		$\leq 105$	

<sup>1)</sup>For calculation of  $R_{thJA}$  please refer to Application Note Thermal Resistance

**Electrical Characteristics at  $T_A = 25^\circ\text{C}$ , unless otherwise specified**

Parameter	Symbol	Values			Unit
		min.	typ.	max.	
<b>DC Characteristics</b>					
Collector-emitter breakdown voltage $I_C = 100 \mu\text{A}, I_B = 0$	$V_{(BR)CEO}$	50	-	-	V
Collector-base breakdown voltage $I_C = 10 \mu\text{A}, I_E = 0$	$V_{(BR)CBO}$	50	-	-	
Collector-base cutoff current $V_{CB} = 40 \text{ V}, I_E = 0$	$I_{CBO}$	-	-	100	nA
Emitter-base cutoff current $V_{EB} = 10 \text{ V}, I_C = 0$	$I_{EBO}$	-	-	0.75	mA
DC current gain <sup>1)</sup> $I_C = 5 \text{ mA}, V_{CE} = 5 \text{ V}$	$h_{FE}$	30	-	-	-
Collector-emitter saturation voltage <sup>1)</sup> $I_C = 10 \text{ mA}, I_B = 0.5 \text{ mA}$	$V_{CEsat}$	-	-	0.3	V
Input off voltage $I_C = 100 \mu\text{A}, V_{CE} = 5 \text{ V}$	$V_{i(off)}$	0.8	-	1.5	
Input on voltage $I_C = 2 \text{ mA}, V_{CE} = 0.3 \text{ V}$	$V_{i(on)}$	1	-	2.5	
Input resistor	$R_1$	7	10	13	k $\Omega$
Resistor ratio	$R_1/R_2$	0.9	1	1.1	-
<b>AC Characteristics</b>					
Transition frequency $I_C = 10 \text{ mA}, V_{CE} = 5 \text{ V}, f = 100 \text{ MHz}$	$f_T$	-	130	-	MHz
Collector-base capacitance $V_{CB} = 10 \text{ V}, f = 1 \text{ MHz}$	$C_{cb}$	-	3	-	pF

<sup>1</sup>Pulse test:  $t < 300 \mu\text{s}$ ;  $D < 2\%$

**DC current gain  $h_{FE} = f(I_C)$**

$V_{CE} = 5\text{ V}$  (common emitter configuration)

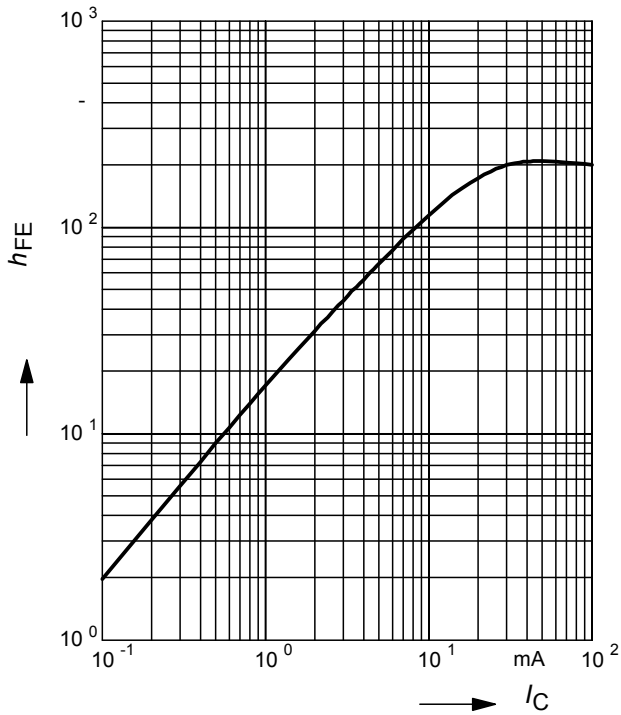

**Collector-emitter saturation voltage**

$V_{CEsat} = f(I_C), h_{FE} = 20$

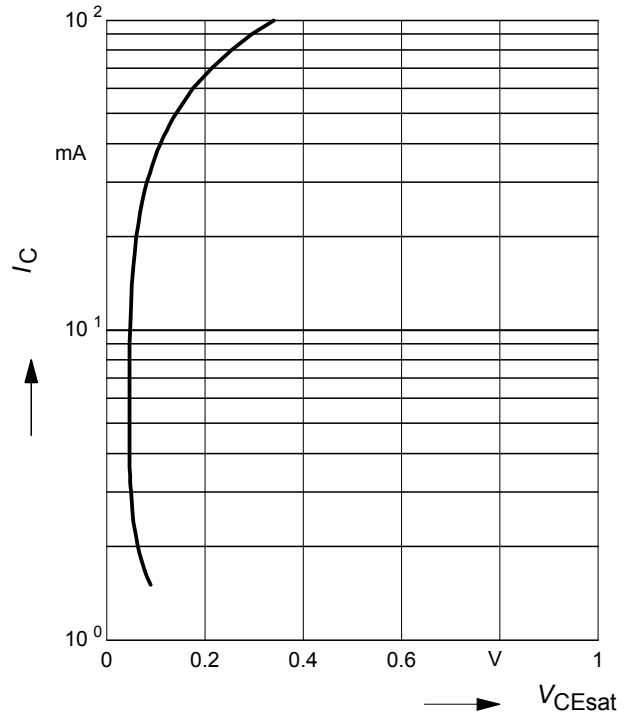

**Input on Voltage  $V_{i(on)} = f(I_C)$**

$V_{CE} = 0.3\text{ V}$  (common emitter configuration)

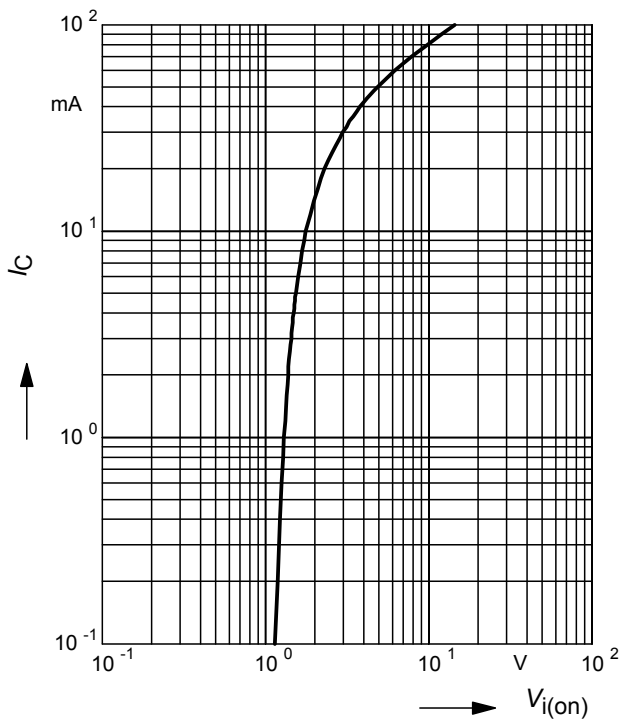

**Input off voltage  $V_{i(off)} = f(I_C)$**

$V_{CE} = 5\text{ V}$  (common emitter configuration)

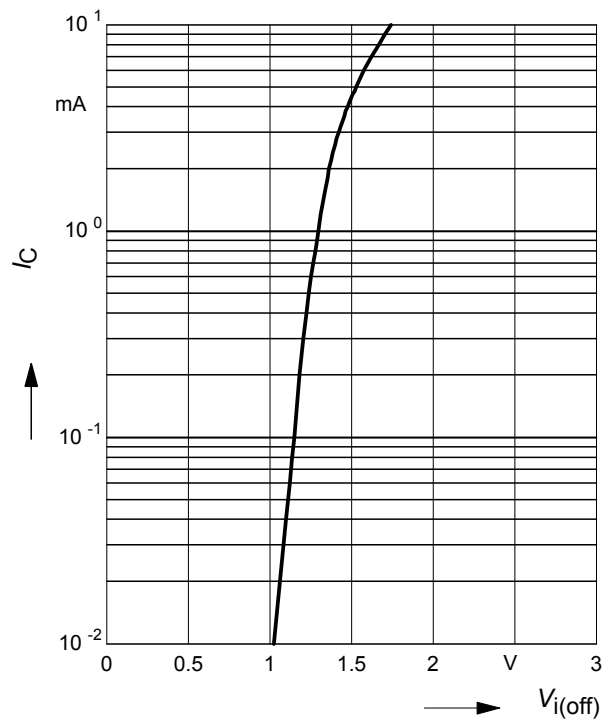

Total power dissipation  $P_{tot} = f(T_S)$

BCR133



Total power dissipation  $P_{tot} = f(T_S)$

BCR133F

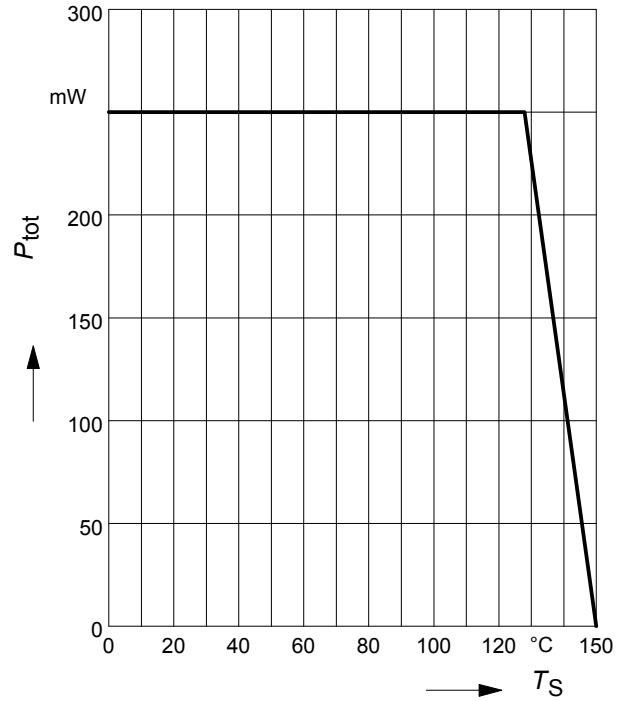

Total power dissipation  $P_{tot} = f(T_S)$

BCR133L3



Total power dissipation  $P_{tot} = f(T_S)$

BCR133S

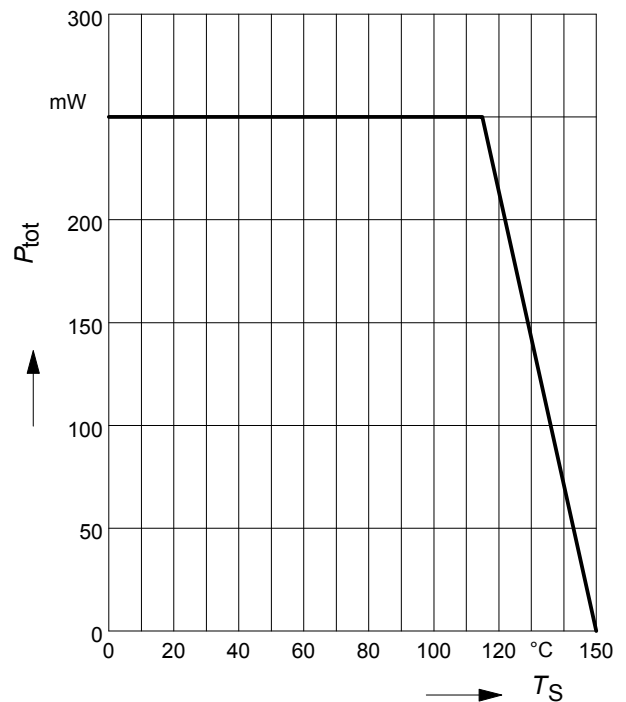

**Total power dissipation  $P_{tot} = f(T_S)$**

BCR133T



**Total power dissipation  $P_{tot} = f(T_S)$**

BCR133W



**Permissible Pulse Load  $R_{thJS} = f(t_p)$**

BCR133

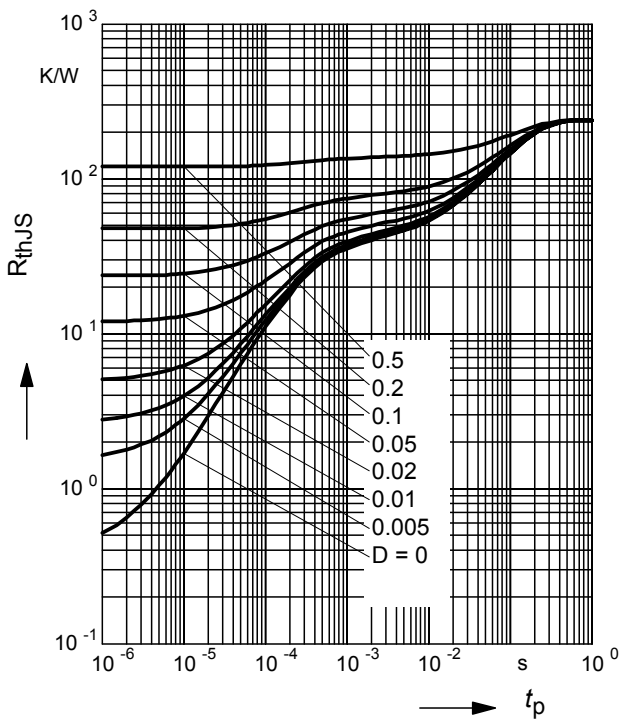

**Permissible Pulse Load**

$P_{totmax}/P_{totDC} = f(t_p)$

BCR133



**Permissible Puls Load  $R_{thJS} = f(t_p)$**

BCR133F



**Permissible Pulse Load**

$P_{totmax}/P_{totDC} = f(t_p)$

BCR133F



**Permissible Puls Load  $R_{thJS} = f(t_p)$**

BCR133L3

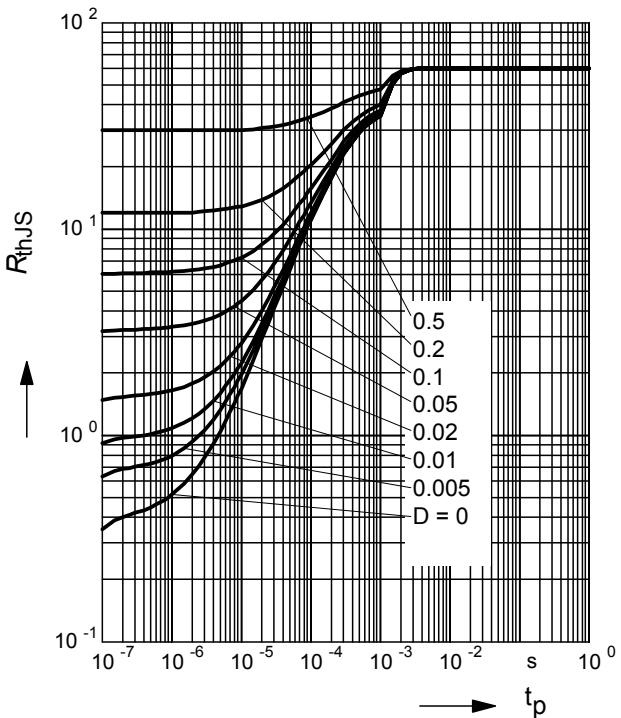

**Permissible Pulse Load**

$P_{totmax}/P_{totDC} = f(t_p)$

BCR133L3



**Permissible Puls Load  $R_{thJS} = f(t_p)$**

BCR133S

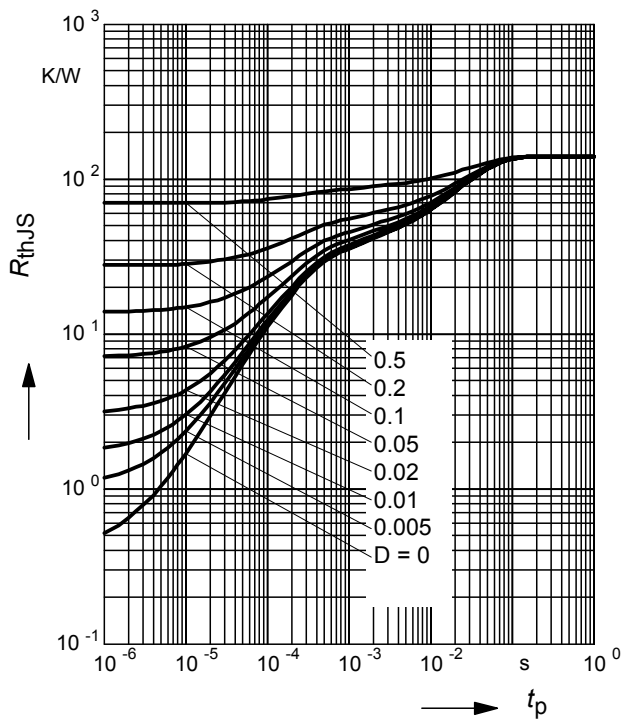

**Permissible Pulse Load**

$P_{totmax}/P_{totDC} = f(t_p)$

BCR133S

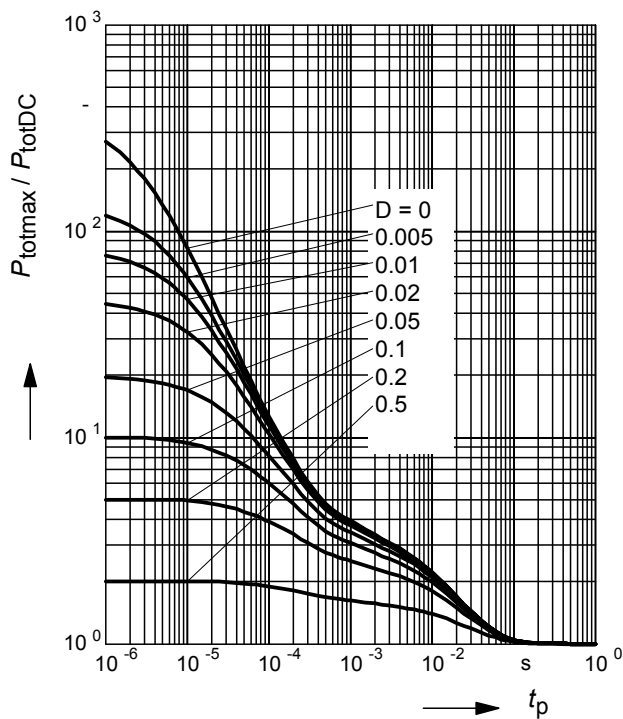

**Permissible Puls Load  $R_{thJS} = f(t_p)$**

BCR133T

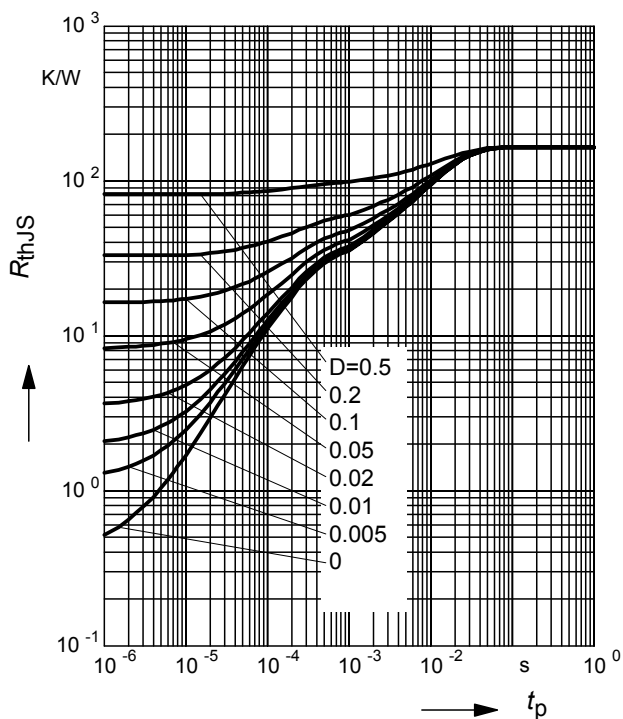

**Permissible Pulse Load**

$P_{totmax}/P_{totDC} = f(t_p)$

BCR133T

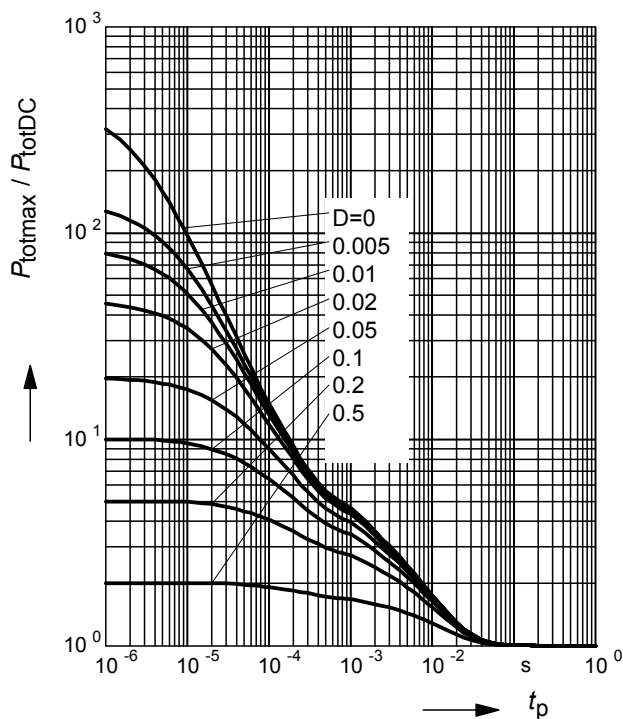



**Permissible Puls Load  $R_{thJS} = f(t_p)$**

BCR133W

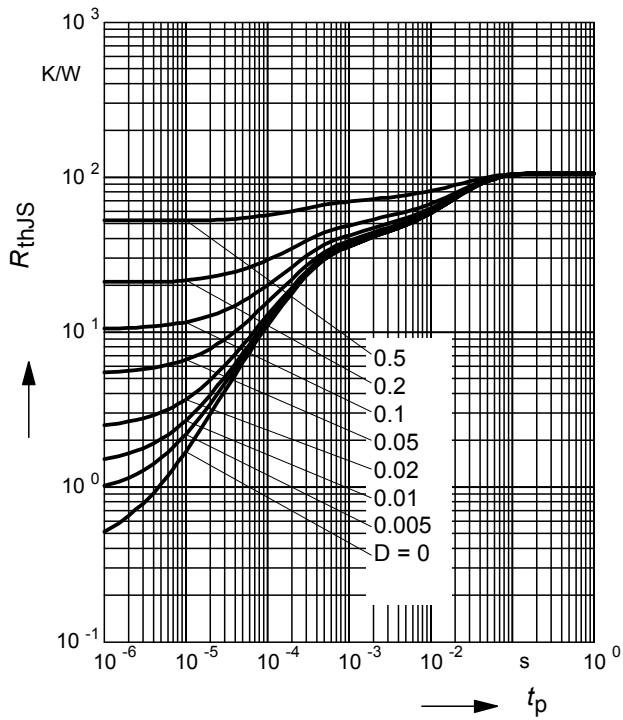

**Permissible Pulse Load**

$P_{totmax}/P_{totDC} = f(t_p)$

BCR133W

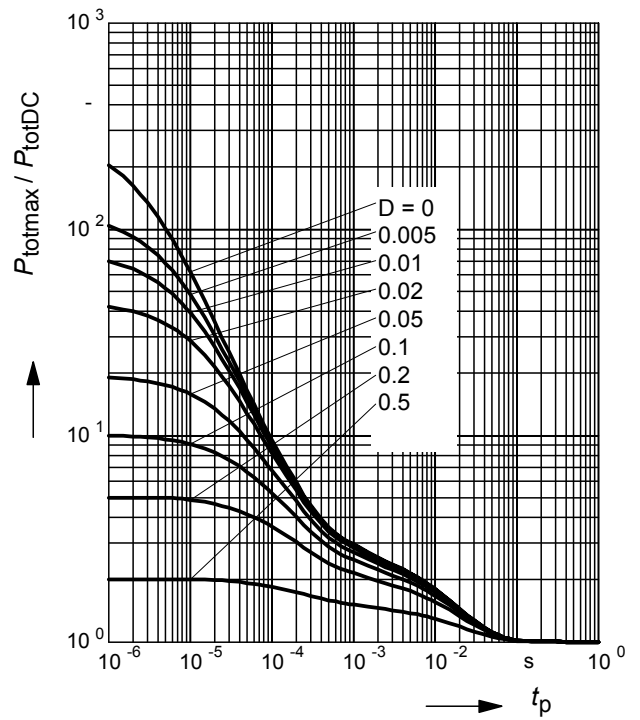

### Package Outline

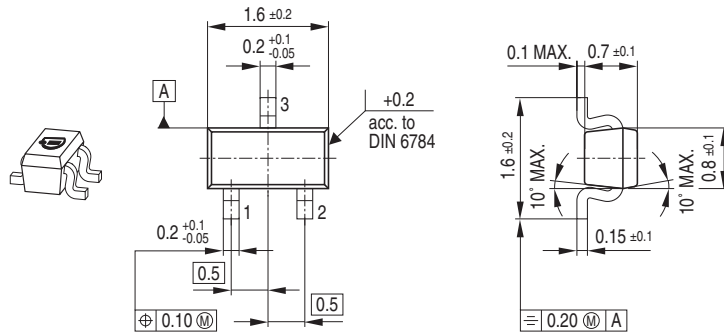

### Foot Print

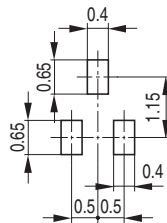

### Marking Layout

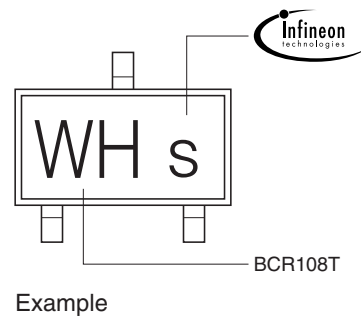
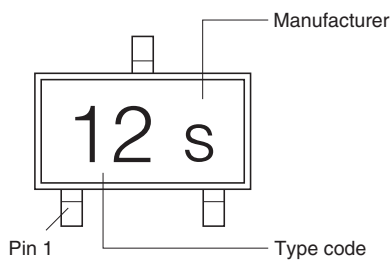

### Packing

Code E6327: Reel  $\varnothing$ 180 mm = 3.000 Pieces/Reel  
 Code E6433: Reel  $\varnothing$ 330 mm = 10.000 Pieces/Reel

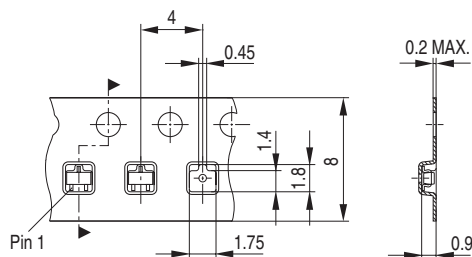

### Package Outline

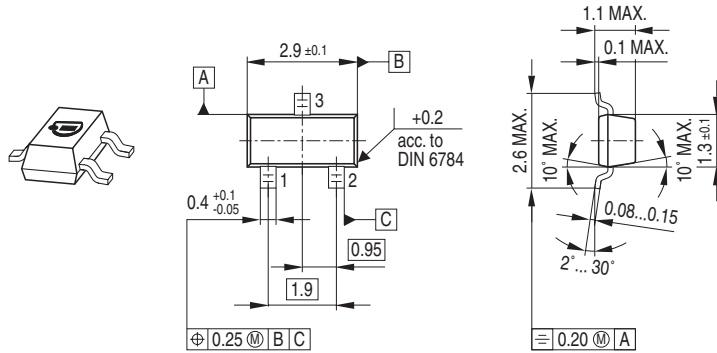

### Foot Print

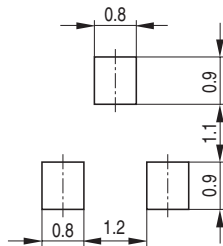

### Marking Layout

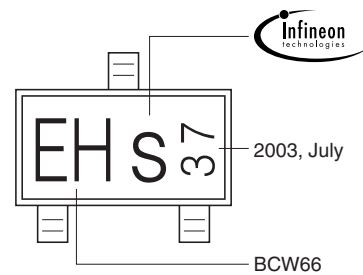
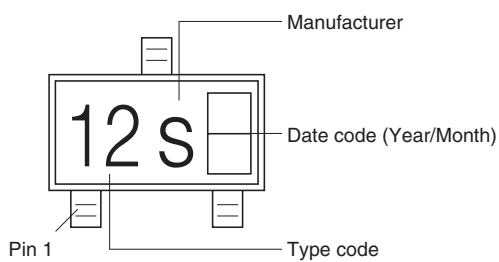

Example

### Packing

Code E6327: Reel  $\varnothing$ 180 mm = 3.000 Pieces/Reel

Code E6433: Reel  $\varnothing$ 330 mm = 10.000 Pieces/Reel

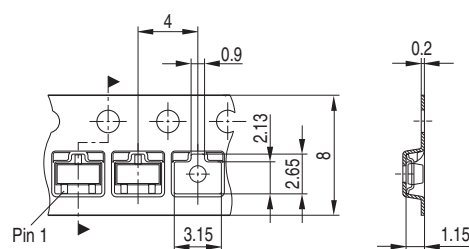

### Package Outline

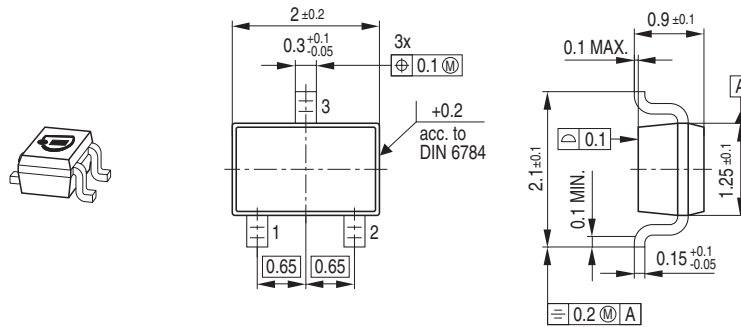

### Foot Print

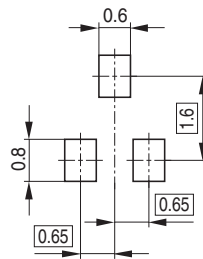

### Marking Layout

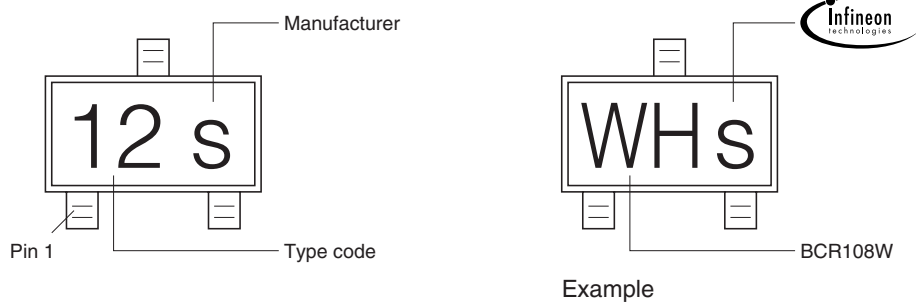

### Packing

Code E6327: Reel  $\varnothing 180$  mm = 3.000 Pieces/Reel  
 Code E6433: Reel  $\varnothing 30$  mm = 10.000 Pieces/Reel

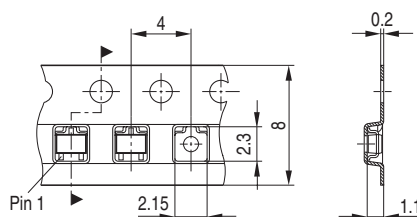

### Package Outline

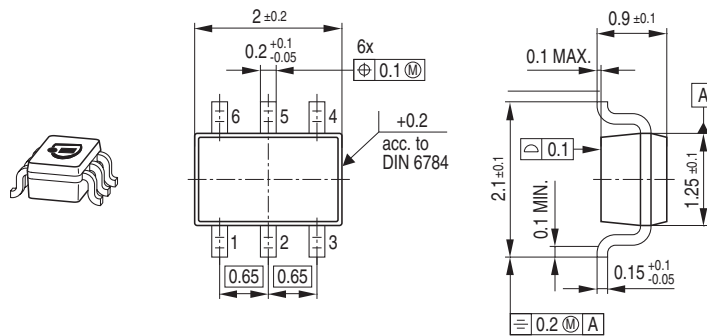

### Foot Print

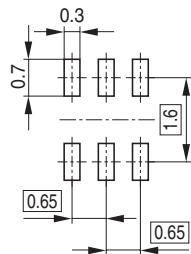

### Marking Layout

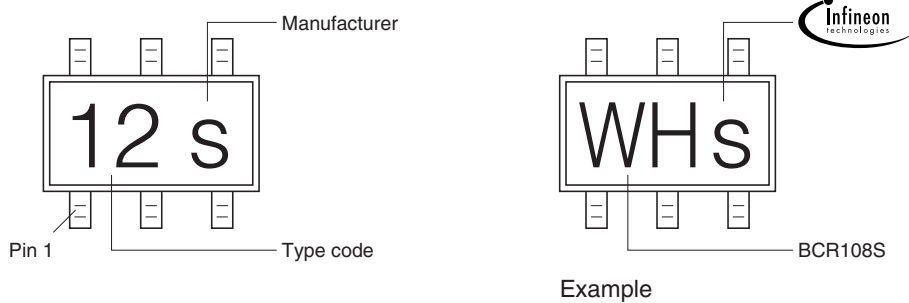

### Packing

Code E6327: Reel  $\varnothing$ 180 mm = 3.000 Pieces/Reel  
 Code E6433: Reel  $\varnothing$ 30 mm = 10.000 Pieces/Reel

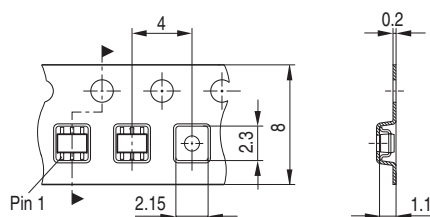

### Package Outline

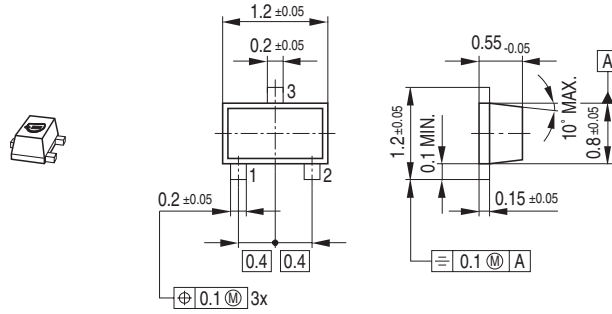

### Foot Print

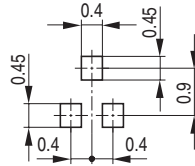

### Marking Layout

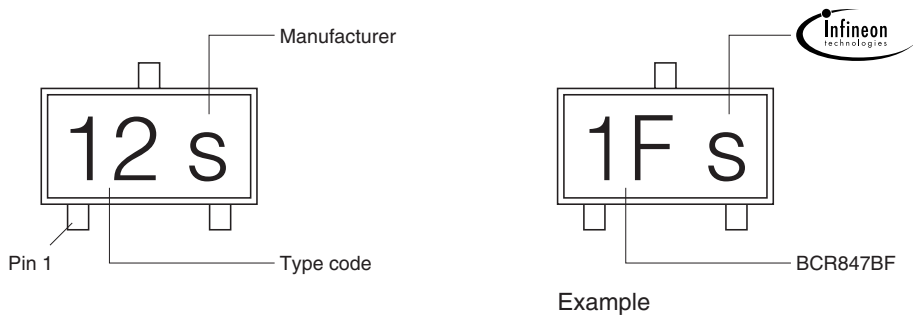

### Packing

Code E6327: Reel  $\varnothing 180$  mm = 3.000 Pieces/Reel  
 Code E6433: Reel  $\varnothing 330$  mm = 10.000 Pieces/Reel

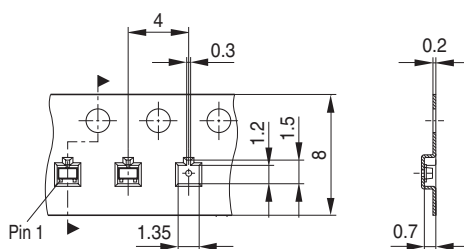



Published by Infineon Technologies AG,  
St.-Martin-Strasse 53,  
81669 München  
© Infineon Technologies AG 2005.  
All Rights Reserved.

### **Attention please!**

The information herein is given to describe certain components and shall not be considered as a guarantee of characteristics.

Terms of delivery and rights to technical change reserved.

We hereby disclaim any and all warranties, including but not limited to warranties of non-infringement, regarding circuits, descriptions and charts stated herein.

### **Information**

For further information on technology, delivery terms and conditions and prices please contact your nearest Infineon Technologies Office ([www.infineon.com](http://www.infineon.com)).

### **Warnings**

Due to technical requirements components may contain dangerous substances. For information on the types in question please contact your nearest Infineon Technologies Office.

Infineon Technologies Components may only be used in life-support devices or systems with the express written approval of Infineon Technologies, if a failure of such components can reasonably be expected to cause the failure of that life-support device or system, or to affect the safety or effectiveness of that device or system. Life support devices or systems are intended to be implanted in the human body, or to support and/or maintain and sustain and/or protect human life. If they fail, it is reasonable to assume that the health of the user or other persons may be endangered.