

# Current Transducer HO-NSM/SP33 series $I_{PN} = 8, 15, 25 A$

Ref: HO 8-NSM/SP33, HO 15-NSM/SP33, HO 25-NSM/SP33

For the electronic measurement of current: DC, AC, pulsed..., with galvanic separation between the primary and the secondary circuit.

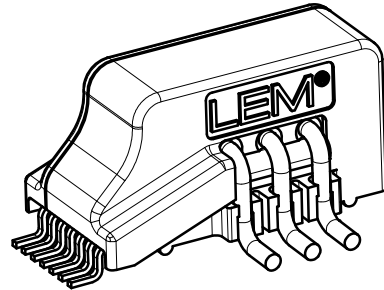

## Features

- Hall effect measuring principle
- Multirange current transducer through PCB pattern lay-out
- Galvanic separation between primary and secondary circuit
- Insulated test voltage 4300 V
- Low power consumption
- Extremely low profile 12 mm
- Fixed offset & sensitivity
- Overcurrent detection  $2.63 \times I_{PN}$  (peak value)
- Memory check.

## Special feature

- Single power supply 3.3 V.

## Advantages

- Small size and space saving
- Only one design for wide primary current range
- High immunity to external interference
- 8 mm creepage /clearance
- Fast response.

## Applications

- AC variable speed drives
- Static converters for DC motor drives
- Battery supplied applications
- Uninterruptible Power Supplies (UPS)
- Switched Mode Power Supplies (SMPS)
- Power supplies for welding applications
- The solar inverter on DC side of the inverter (MPPT)
- Combiner box.

## Standards

- EN 50178: 1997
- IEC 61010-1: 2010
- IEC 61326-1: 2012
- UL 508: 2010.

## Application Domain

- Industrial.

## Absolute maximum ratings

| Parameter  | Symbol         | Unit | Value |
|--|----------------|------|-------|
| Maximum supply voltage (not operating)                   | $U_{C\ max}$   | V    | 6.5   |
| Maximum primary conductor temperature                    | $T_{B\ max}$   | °C   | 120   |
| Electrostatic discharge voltage (HBM - Human Body Model) | $U_{ESD\ HBM}$ | kV   | 2     |

Stresses above these ratings may cause permanent damage. Exposure to absolute maximum ratings for extended periods may degrade reliability.

## UL 508: Ratings and assumptions of certification

File # E189713 Volume: 2 Section: 5

### Standards

- CSA C22.2 NO. 14-10 INDUSTRIAL CONTROL EQUIPMENT - Edition 11
- UL 508 STANDARD FOR INDUSTRIAL CONTROL EQUIPMENT - Edition 17

### Ratings

| Parameter                                | Unit    | Value                                |
|--|---------|--------------------------------------|
| Primary potential involved <sup>1)</sup> | V AC/DC | 1000                                 |
| Maximum surrounding air temperature      | °C      | 105                                  |
| Primary current                          | A       | According to series primary currents |
| Transducer supply voltage                | V DC    | 0 ... 3.3                            |
| Output voltage                           | V       | 0 ... 3.3                            |

Note: <sup>1)</sup>Primary potential involved is 600 AC/DC according to Canadian Standard CSA C22.2.

### Conditions of acceptability

When installed in the end-use equipment, consideration shall be given to the following:

- 1 - These devices have been evaluated for overvoltage category III and for use in pollution degree 2 environment.
- 2 - A suitable enclosure shall be provided in the end-use application.
- 3 - The terminals have not been evaluated for field wiring.
- 4 - These devices have been evaluated for use in 105 °C maximum surrounding air temperature.
- 5 - The secondary (Sensing) circuit is intended to be supplied by a Isolated Secondary Circuit - Limited voltage circuit defined by UL 508 paragraph 32.5. The maximum open circuit voltage potential available to the circuit and overcurrent protection shall be evaluated in the end use application.
- 6 - These devices are intended to be mounted on a printed wiring board of end-use equipment. The suitability of the connections (including spacings) shall be determined in the end-use application.
- 7 - Primary terminals shall not be straightened since assembly of housing case depends upon bending of the terminals.
- 8 - Any surface of polymeric housing have not been evaluated as insulating barrier.
- 9 - Low voltage circuits are intended to be powered by a circuit derived from an isolating source (such as a transformer, optical isolator, limiting impedance or electro-mechanical relay) and having no direct connection back to the primary circuit (other than through the grounding means).

### Marking

Only those products bearing the UL or UR Mark should be considered to be Listed or Recognized and covered under UL's Follow-Up Service. Always look for the Mark on the product.

**Insulation coordination**

| Parameter   | Symbol   | Unit | Value | Comment   |
|---|----------|------|-------|---|
| RMS voltage for AC insulation test, 50/60 Hz, 1 min | $U_d$    | kV   | 4.3   |   |
| Impulse withstand voltage 1.2/50 $\mu$ s            | $U_{Ni}$ | kV   | 8     |   |
| Partial discharge extinction RMS voltage @ 10 pC    | $U_e$    | V    | 1650  |   |
| Clearance (pri. - sec.)                             | $d_{Cl}$ | mm   | 8     | Shortest distance through air   |
| Creepage distance (pri. - sec.)                     | $d_{Cp}$ | mm   | 8     | Shortest path along device body   |
| Case material                                       | -        | -    | V0    | According to UL 94  |
| Comparative tracking index                          | $CTI$    |      | 600   |   |
| Application example                                 |          | V    | 600   | Reinforced insulation, CAT III, PD 2, non uniform field according to EN 50178       |
| Application example                                 |          | V    | 300   | Reinforced insulation, CAT III, PD 2, non uniform field according to IEC 61010      |
| Application example                                 |          | V    | 1000  | Basic insulation, CAT III, PD 2, non uniform field according to EN 50178, IEC 61010 |

**Environmental and mechanical characteristics**

| Parameter                                   | Symbol | Unit         | Min | Typ | Max | Comment |
|---|--------|--------------|-----|-----|-----|---------|
| Ambient operating temperature               | $T_A$  | $^{\circ}$ C | -40 |     | 105 |         |
| Ambient storage temperature                 | $T_S$  | $^{\circ}$ C | -40 |     | 105 |         |
| Surrounding temperature according to UL 508 |        | $^{\circ}$ C |     |     | 105 |         |
| Mass  | $m$    | g            |     | 5   |     |         |

**Electrical data HO 8-NSM/SP33-1000**

At  $T_A = 25\text{ °C}$ ,  $U_C = +3.3\text{ V}$ ,  $N_P = 1\text{ turn}$ ,  $R_L = 10\text{ K}\Omega$  unless otherwise noted (see Min, Max, typ. definition paragraph in page 12).

| Parameter   | Symbol              | Unit                           | Min                 | Typ                 | Max                 | Comment                                 |
|---|---------------------|--------------------------------|---------------------|---------------------|---------------------|---|
| Primary nominal RMS current   | $I_{PN}$            | At                             |                     | 8                   |                     |   |
| Primary current, measuring range  | $I_{PM}$            | At                             | -20                 |                     | 20                  |   |
| Number of primary turns   | $N_P$               |                                |                     | 1,2,3               |                     |   |
| Supply voltage  | $U_C$               | V                              | 3.14                | 3.3                 | 3.46                |   |
| Current consumption   | $I_C$               | mA                             |                     |                     | 25                  |   |
| Reference voltage   | $V_{ref}$           | V                              | 1.636               | 1.65                | 1.664               | Internal reference                      |
| External reference voltage  | $V_{ref}$           | V                              | 0.5                 |                     | 1.85                | @ $U_C = 3.3 \approx 3.46\text{ V}$     |
|   |                     |                                | 0.5                 |                     | 1.7                 | @ $U_C = 3.14 \approx 3.3\text{ V}$     |
| Output voltage range @ $I_{PM}$   | $V_{out} - V_{ref}$ | V                              | -1.15               |                     | 1.15                |   |
| Output voltage @ $I_P = 0\text{ A}$   | $V_{out}$           | V                              |                     | $V_{ref} + V_{OE}$  |                     |   |
| Electrical offset voltage   | $V_{OE}$            | mV                             | -7                  |                     | 7                   |   |
| Temperature coefficient of $V_{ref}$  | $TCV_{ref}$         | ppm/K                          |                     |                     | $\pm 170$           | -20 °C ... 85 °C<br>Internal reference  |
|   |                     |                                |                     |                     | $\pm 180$           | -40 °C ... 105 °C<br>Internal reference |
| Temperature coefficient of $V_{OE}$   | $TCV_{OE}$          | mV/K                           |                     |                     | $\pm 0.080$         | -40 °C ... 105 °C                       |
| Theoretical sensitivity   | $G_{th}$            | mV/A                           |                     | 57.5                |                     | 460 mV/ $I_{PN}$ @ $U_C = 3.3\text{ V}$ |
| Sensitivity error   | $\epsilon_G$        | %                              |                     |                     | $\pm 0.5$           | Factory adjustment                      |
| Temperature coefficient of $G$  | $TCG$               | ppm/K                          |                     |                     | $\pm 200$           | -20 °C ... 85 °C                        |
|   |                     |                                |                     |                     | $\pm 210$           | -40 °C ... 105 °C                       |
| Linearity error 0 ... $I_{PN}$  | $\epsilon_L$        | % of $I_{PN}$                  |                     |                     | $\pm 0.5$           | @ $U_C = 3.3\text{ V}$                  |
| Linearity error 0 ... $I_{PM}$  | $\epsilon_L$        | % of $I_{PM}$                  |                     |                     | $\pm 0.8$           | @ $U_C = 3.3\text{ V}$                  |
| Sensitivity error with respect to $U_C \pm 10\%$                                | $\epsilon_G$        | %/%                            |                     |                     | $\pm 0.4$           | Sensitivity error per $U_C$ drift       |
| Magnetic offset voltage<br>@ $I_P = 0$ after an overload of $2.5 \times I_{PN}$ | $V_{OM}$            | mV                             |                     |                     | $\pm 4$             |   |
| Reaction time @ 10 % of $I_{PN}$  | $t_{ra}$            | $\mu\text{s}$                  |                     |                     | 2                   | $di/dt = I_{PN}/\mu\text{s}$            |
| Step response time to 90 % of $I_{PN}$  | $t_r$               | $\mu\text{s}$                  |                     |                     | 3.5                 | $di/dt = I_{PN}/\mu\text{s}$            |
| Frequency bandwidth (-3 dB)   | $BW$                | kHz                            |                     | 250                 |                     |   |
| Output noise voltage spectral density<br>(DC ... 100 kHz)                       | $e_{no}$            | $\mu\text{V}/\sqrt{\text{Hz}}$ |                     |                     | 18.9                |   |
| Output RMS noise voltage<br>(DC ... 20 MHz)                                     | $V_{no}$            | mVpp                           |                     | 40                  |                     |   |
| Standby pin "0" level   |                     | V                              |                     |                     | 0.3                 |   |
| Standby pin "1" level   |                     | V                              | $U_C - 0.3$         |                     |                     |   |
| Time to switch from standby to normal mode                                      |                     | $\mu\text{s}$                  |                     |                     | 20                  |   |
| Primary current, detection threshold  | $I_{PTh}$           | A                              | $2.6 \times I_{PN}$ | $2.9 \times I_{PN}$ | $3.2 \times I_{PN}$ | peak value                              |
| Accuracy @ $I_{PN}$   | $X$                 | % of $I_{PN}$                  |                     |                     | $\pm 1$             | $= \epsilon_G + \epsilon_L$             |
| Accuracy @ $I_{PN}$ @ $T_A = +85\text{ °C}$                                     | $X$                 | % of $I_{PN}$                  |                     |                     | $\pm 3.3$           | See formula note <sup>1)</sup>          |
| Accuracy @ $I_{PN}$ @ $T_A = +105\text{ °C}$                                    | $X$                 | % of $I_{PN}$                  |                     |                     | $\pm 4.1$           | See formula note <sup>1)</sup>          |

Note: <sup>1)</sup> Accuracy @  $I_P$  and  $T_A = \pm [X + (TCG/10000) \cdot (T_A - 25) + TCV_{OE} \cdot 100 \cdot (T_A - 25) / (G_{th} \cdot I_P)]$ .

**Electrical data HO 15-NSM/SP33-1000**

 At  $T_A = 25\text{ °C}$ ,  $U_C = +3.3\text{ V}$ ,  $N_P = 1\text{ turn}$ ,  $R_L = 10\text{ K}\Omega$  unless otherwise noted (see Min, Max, typ. definition paragraph in page 12).

| Parameter   | Symbol              | Unit                           | Min                 | Typ                 | Max                 | Comment                                 |
|---|---------------------|--------------------------------|---------------------|---------------------|---------------------|---|
| Primary nominal RMS current   | $I_{PN}$            | At                             |                     | 15                  |                     |   |
| Primary current, measuring range  | $I_{PM}$            | At                             | -37.5               |                     | 37.5                |   |
| Number of primary turns   | $N_P$               |                                |                     | 1,2,3               |                     |   |
| Supply voltage  | $U_C$               | V                              | 3.14                | 3.3                 | 3.46                |   |
| Current consumption   | $I_C$               | mA                             |                     |                     | 25                  |   |
| Reference voltage   | $V_{ref}$           | V                              | 1.636               | 1.65                | 1.664               | Internal reference                      |
| External reference voltage  | $V_{ref}$           | V                              | 0.5                 |                     | 1.85                | @ $U_C = 3.3 \approx 3.46\text{ V}$     |
|   |                     |                                | 0.5                 |                     | 1.7                 | @ $U_C = 3.14 \approx 3.3\text{ V}$     |
| Output voltage range @ $I_{PM}$   | $V_{out} - V_{ref}$ | V                              | -1.15               |                     | 1.15                |   |
| Output voltage @ $I_P = 0\text{ A}$   | $V_{out}$           | V                              |                     | $V_{ref} + V_{OE}$  |                     |   |
| Electrical offset voltage   | $V_{OE}$            | mV                             | -5                  |                     | 5                   |   |
| Temperature coefficient of $V_{ref}$  | $TCV_{ref}$         | ppm/K                          |                     |                     | $\pm 170$           | -20 °C ... 85 °C<br>Internal reference  |
|   |                     |                                |                     |                     | $\pm 180$           | -40 °C ... 105 °C<br>Internal reference |
| Temperature coefficient of $V_{OE}$   | $TCV_{OE}$          | mV/K                           |                     |                     | $\pm 0.080$         | -40 °C ... 105 °C                       |
| Theoretical sensitivity   | $G_{th}$            | mV/A                           |                     | 30.67               |                     | 460 mV/ $I_{PN}$ @ $U_C = 3.3\text{ V}$ |
| Sensitivity error   | $\epsilon_G$        | %                              |                     |                     | $\pm 0.5$           | Factory adjustment                      |
| Temperature coefficient of $G$  | $TCG$               | ppm/K                          |                     |                     | $\pm 200$           | -20 °C ... 85 °C                        |
|   |                     |                                |                     |                     | $\pm 210$           | -40 °C ... 105 °C                       |
| Linearity error 0 ... $I_{PN}$  | $\epsilon_L$        | % of $I_{PN}$                  |                     |                     | $\pm 0.5$           | @ $U_C = 3.3\text{ V}$                  |
| Linearity error 0 ... $I_{PM}$  | $\epsilon_L$        | % of $I_{PM}$                  |                     |                     | $\pm 0.8$           | @ $U_C = 3.3\text{ V}$                  |
| Sensitivity error with respect to $U_C \pm 10\%$                                | $\epsilon_G$        | %/%                            |                     |                     | $\pm 0.4$           | Sensitivity error per $U_C$ drift       |
| Magnetic offset voltage<br>@ $I_P = 0$ after an overload of $2.5 \times I_{PN}$ | $V_{OM}$            | mV                             |                     |                     | $\pm 4$             |   |
| Reaction time @ 10 % of $I_{PN}$  | $t_{ra}$            | $\mu\text{s}$                  |                     |                     | 2                   | $di/dt = I_{PN}/\mu\text{s}$            |
| Step response time to 90 % of $I_{PN}$  | $t_r$               | $\mu\text{s}$                  |                     |                     | 3.5                 | $di/dt = I_{PN}/\mu\text{s}$            |
| Frequency bandwidth (-3 dB)   | $BW$                | kHz                            |                     | 250                 |                     |   |
| Output noise voltage spectral density<br>(DC ... 100 kHz)                       | $e_{no}$            | $\mu\text{V}/\sqrt{\text{Hz}}$ |                     |                     | 10.15               |   |
| Output RMS noise voltage<br>(DC ... 20 MHz)                                     | $V_{no}$            | mVpp                           |                     | 30                  |                     |   |
| Standby pin "0" level   |                     | V                              |                     |                     | 0.3                 |   |
| Standby pin "1" level   |                     | V                              | $U_C - 0.3$         |                     |                     |   |
| Time to switch from standby to normal mode                                      |                     | $\mu\text{s}$                  |                     |                     | 20                  |   |
| Primary current, detection threshold  | $I_{PTh}$           | A                              | $2.6 \times I_{PN}$ | $2.9 \times I_{PN}$ | $3.2 \times I_{PN}$ | peak value                              |
| Accuracy @ $I_{PN}$   | $X$                 | % of $I_{PN}$                  |                     |                     | $\pm 1$             | $= \epsilon_G + \epsilon_L$             |
| Accuracy @ $I_{PN}$ @ $T_A = +85\text{ °C}$                                     | $X$                 | % of $I_{PN}$                  |                     |                     | $\pm 3.3$           | See formula note <sup>1)</sup>          |
| Accuracy @ $I_{PN}$ @ $T_A = +105\text{ °C}$                                    | $X$                 | % of $I_{PN}$                  |                     |                     | $\pm 4.1$           | See formula note <sup>1)</sup>          |

 Note: <sup>1)</sup> Accuracy @  $I_P$  and  $T_A = \pm [X + (TCG/10000) \cdot (T_A - 25) + TCV_{OE} \cdot 100 \cdot (T_A - 25)] / (G_{th} \cdot I_P)$ .

**Electrical data HO 25-NSM/SP33-1000**

 At  $T_A = 25\text{ °C}$ ,  $U_C = +3.3\text{ V}$ ,  $N_P = 1\text{ turn}$ ,  $R_L = 10\text{ K}\Omega$  unless otherwise noted (see Min, Max, typ. definition paragraph in page 12).

| Parameter   | Symbol              | Unit                           | Min                 | Typ                 | Max                 | Comment                                 |
|---|---------------------|--------------------------------|---------------------|---------------------|---------------------|---|
| Primary nominal RMS current   | $I_{PN}$            | At                             |                     | 25                  |                     |   |
| Primary current, measuring range  | $I_{PM}$            | At                             | -62.5               |                     | 62.5                |   |
| Number of primary turns   | $N_P$               |                                |                     | 1,2,3               |                     |   |
| Supply voltage  | $U_C$               | V                              | 3.14                | 3.3                 | 3.46                |   |
| Current consumption   | $I_C$               | mA                             |                     |                     | 25                  |   |
| Reference voltage   | $V_{ref}$           | V                              | 1.636               | 1.65                | 1.664               | Internal reference                      |
| External reference voltage  | $V_{ref}$           | V                              | 0.5                 |                     | 1.85                | @ $U_C = 3.3 \approx 3.46\text{ V}$     |
|   |                     |                                | 0.5                 |                     | 1.7                 | @ $U_C = 3.14 \approx 3.3\text{ V}$     |
| Output voltage range @ $I_{PM}$   | $V_{out} - V_{ref}$ | V                              | -1.15               |                     | 1.15                |   |
| Output voltage @ $I_P = 0\text{ A}$   | $V_{out}$           | V                              |                     | $V_{ref} + V_{OE}$  |                     |   |
| Electrical offset voltage   | $V_{OE}$            | mV                             | -6                  |                     | 6                   |   |
| Temperature coefficient of $V_{ref}$  | $TCV_{ref}$         | ppm/K                          |                     |                     | $\pm 170$           | -20 °C ... 85 °C<br>Internal reference  |
|   |                     |                                |                     |                     | $\pm 180$           | -40 °C ... 105 °C<br>Internal reference |
| Temperature coefficient of $V_{OE}$   | $TCV_{OE}$          | mV/K                           |                     |                     | $\pm 0.080$         | -40 °C ... 105 °C                       |
| Theoretical sensitivity   | $G_{th}$            | mV/A                           |                     | 18.4                |                     | 460 mV/ $I_{PN}$ @ $U_C = 3.3\text{ V}$ |
| Sensitivity error   | $\epsilon_G$        | %                              |                     |                     | $\pm 0.5$           | Factory adjustment                      |
| Temperature coefficient of $G$  | $TCG$               | ppm/K                          |                     |                     | $\pm 200$           | -20 °C ... 85 °C                        |
|   |                     |                                |                     |                     | $\pm 210$           | -40 °C ... 105 °C                       |
| Linearity error 0 ... $I_{PN}$  | $\epsilon_L$        | % of $I_{PN}$                  |                     |                     | $\pm 0.5$           | @ $U_C = 3.3\text{ V}$                  |
| Linearity error 0 ... $I_{PM}$  | $\epsilon_L$        | % of $I_{PM}$                  |                     |                     | $\pm 0.8$           | @ $U_C = 3.3\text{ V}$                  |
| Sensitivity error with respect to $U_C \pm 10\%$                                | $\epsilon_G$        | %/%                            |                     |                     | $\pm 0.4$           | Sensitivity error per $U_C$ drift       |
| Magnetic offset voltage<br>@ $I_P = 0$ after an overload of $2.5 \times I_{PN}$ | $V_{OM}$            | mV                             |                     |                     | $\pm 4$             |   |
| Reaction time @ 10 % of $I_{PN}$  | $t_{ra}$            | $\mu\text{s}$                  |                     |                     | 2                   | $di/dt = I_{PN}/\mu\text{s}$            |
| Step response time to 90 % of $I_{PN}$  | $t_r$               | $\mu\text{s}$                  |                     |                     | 3.5                 | $di/dt = I_{PN}/\mu\text{s}$            |
| Frequency bandwidth (-3 dB)   | $BW$                | kHz                            |                     | 250                 |                     |   |
| Output noise voltage spectral density<br>(DC ... 100 kHz)                       | $e_{no}$            | $\mu\text{V}/\sqrt{\text{Hz}}$ |                     |                     | 6.13                |   |
| Output RMS noise voltage<br>(DC ... 20 MHz)                                     | $V_{no}$            | mVpp                           |                     | 20                  |                     |   |
| Standby pin "0" level   |                     | V                              |                     |                     | 0.3                 |   |
| Standby pin "1" level   |                     | V                              | $U_C - 0.3$         |                     |                     |   |
| Time to switch from standby to normal mode                                      |                     | $\mu\text{s}$                  |                     |                     | 20                  |   |
| Primary current, detection threshold  | $I_{PTh}$           | A                              | $2.6 \times I_{PN}$ | $2.9 \times I_{PN}$ | $3.2 \times I_{PN}$ | peak value                              |
| Accuracy @ $I_{PN}$   | $X$                 | % of $I_{PN}$                  |                     |                     | $\pm 1$             | $= \epsilon_G + \epsilon_L$             |
| Accuracy @ $I_{PN}$ @ $T_A = +85\text{ °C}$                                     | $X$                 | % of $I_{PN}$                  |                     |                     | $\pm 3.3$           | See formula note <sup>1)</sup>          |
| Accuracy @ $I_{PN}$ @ $T_A = +105\text{ °C}$                                    | $X$                 | % of $I_{PN}$                  |                     |                     | $\pm 4.1$           | See formula note <sup>1)</sup>          |

 Note: <sup>1)</sup> Accuracy @  $I_P$  and  $T_A = \pm [X + (TCG/10000) \cdot (T_A - 25) + TCV_{OE} \cdot 100 \cdot (T_A - 25) / (G_{th} \cdot I_P)]$ .

Typical performance characteristics  $I_{PN} = 8\text{ A}$

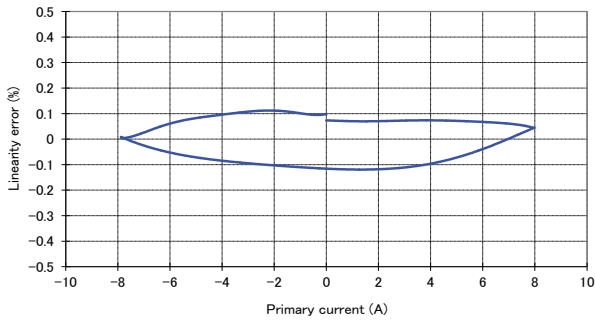

Figure 1: Linearity error

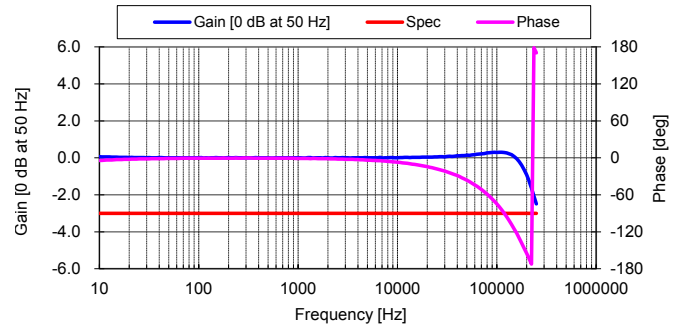

Figure 2: Frequency response

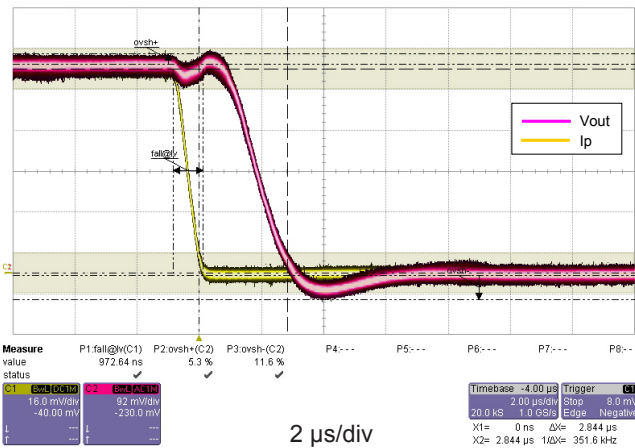

Figure 3: Step response

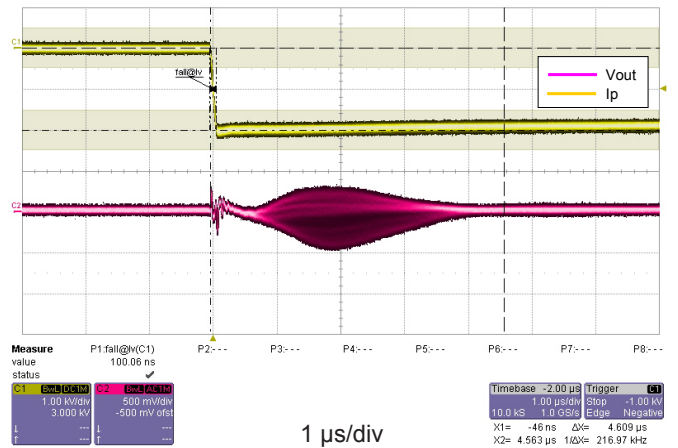

Figure 4:  $dv/dt$

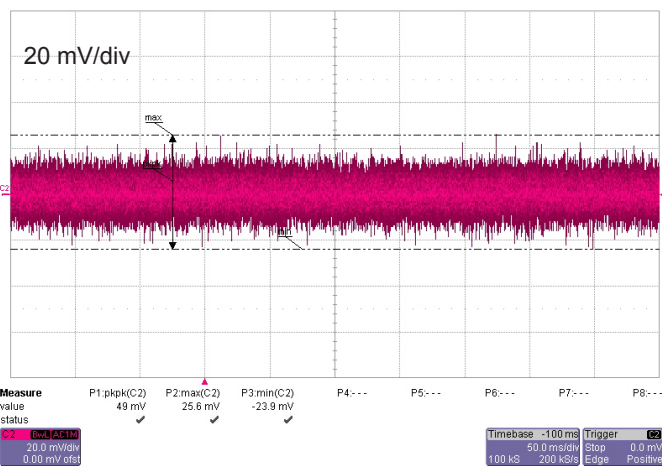

Figure 5: Output noise



Typical performance characteristics  $I_{PN} = 15\text{ A}$

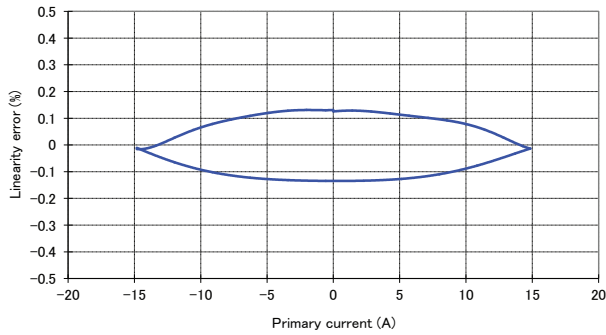

Figure 6: Linearity error

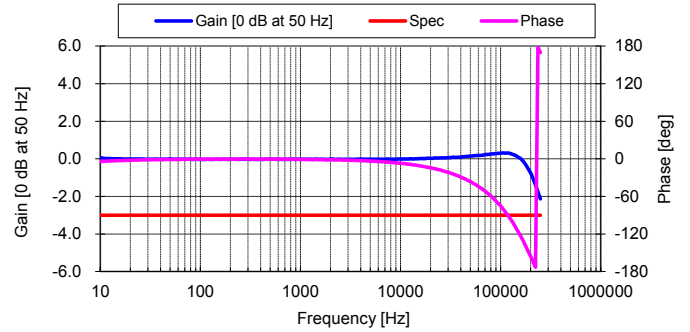

Figure 7: Frequency response

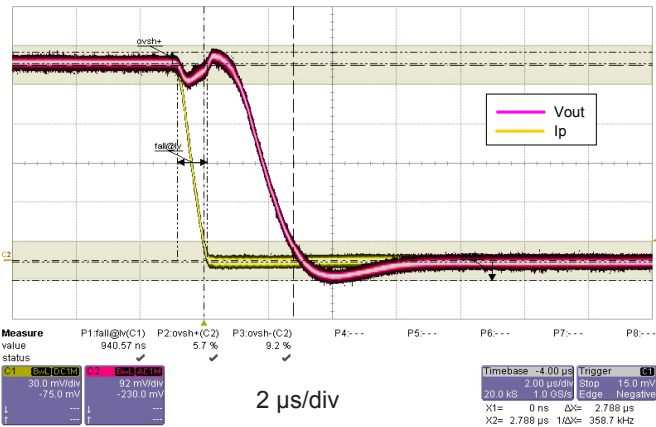

Figure 8: Step response

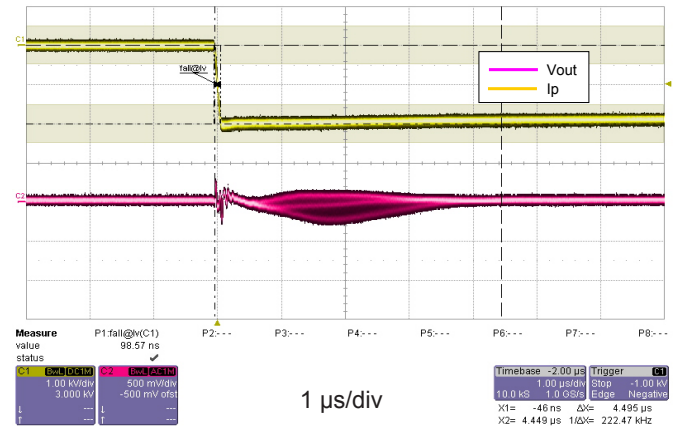

Figure 9: dv/dt

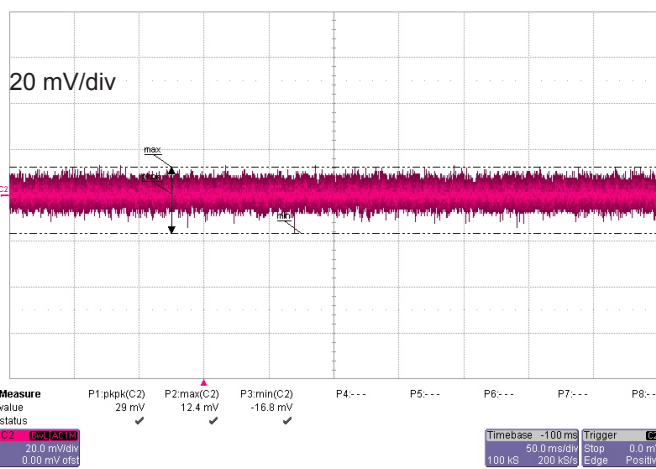

Figure 10: Output noise



Typical performance characteristics  $I_{PN} = 25\text{ A}$

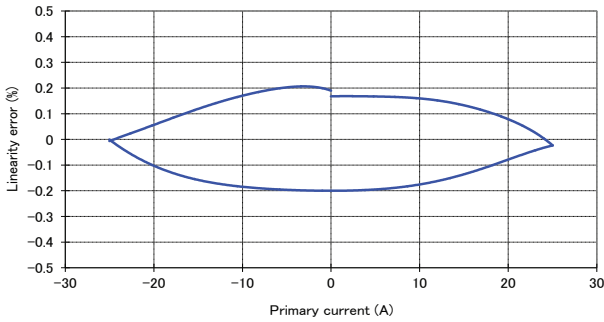

Figure 11: Linearity error

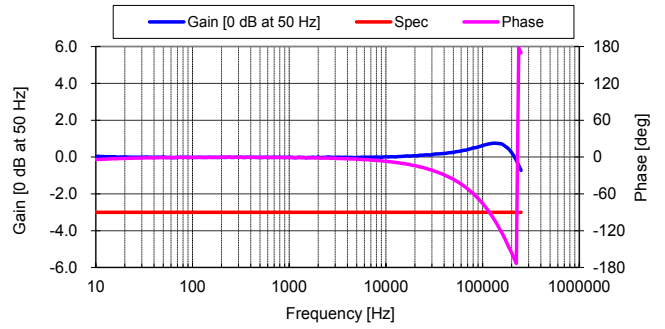

Figure 12: Frequency response

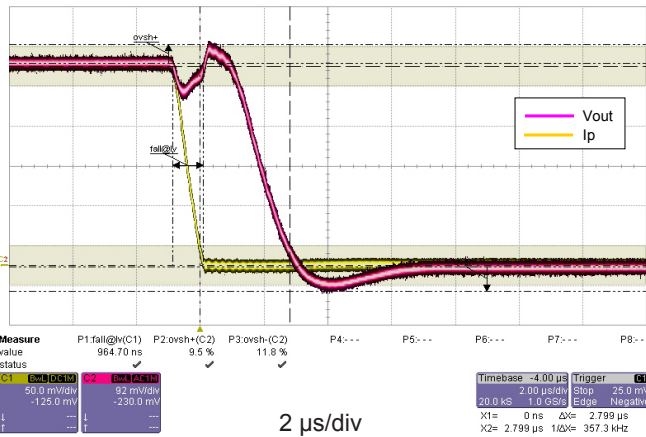

Figure 13: Step response

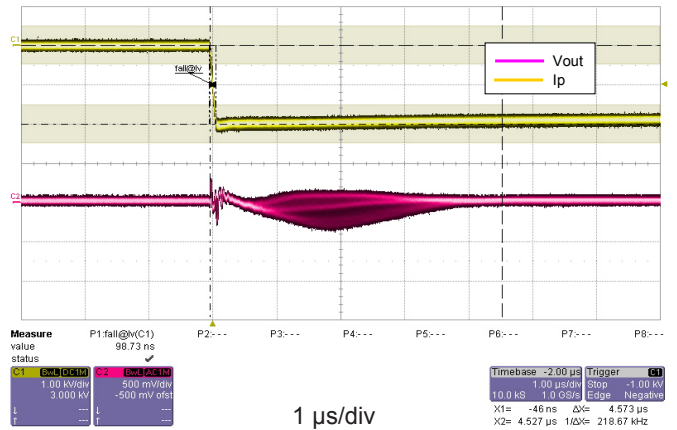

Figure 14:  $dv/dt$

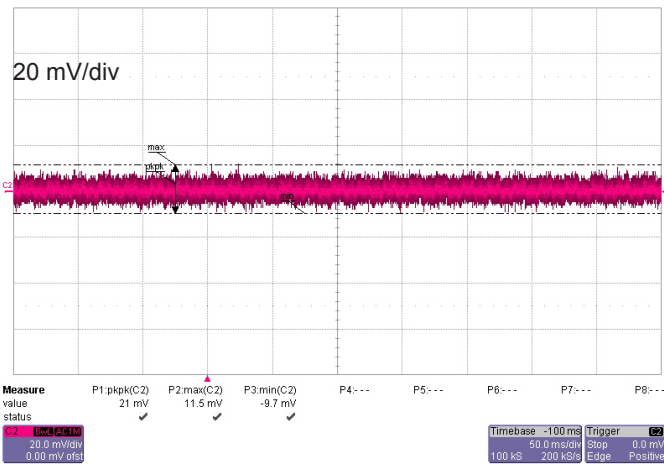

Figure 15: Output noise

Maximum continuous DC primary current

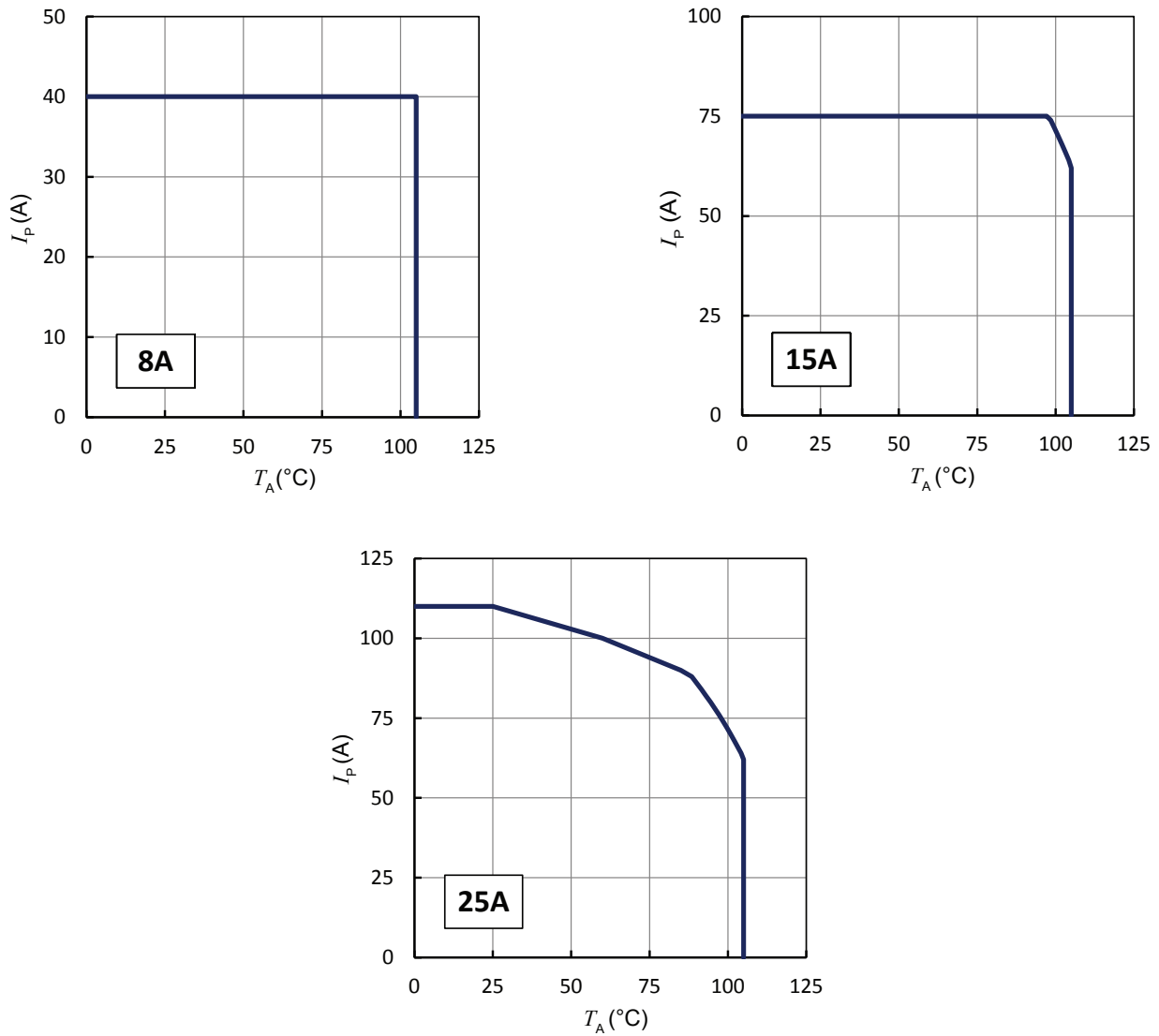
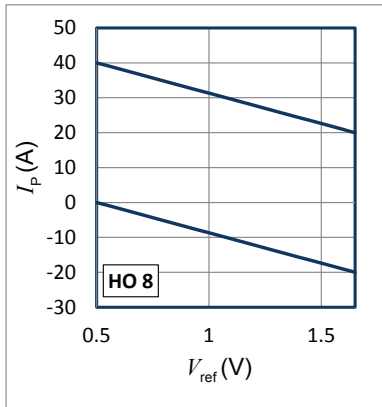

Figure 16:  $I_p$  vs  $T_A$  for HO series

**Important notice:** whatever the usage and/or application, the transducer jumper temperature shall not go above the maximum rating of 120 °C as stated in page 2 of this datasheet.

## Measuring range with external reference voltage



Upper limit:  $I_p = 17.39 \times V_{ref} + 48.7$  ( $V_{ref} = 0.5 \dots 1.65$  V)

Lower limit:  $I_p = 17.39 \times V_{ref} + 8.7$  ( $V_{ref} = 0.5 \dots 1.65$  V)

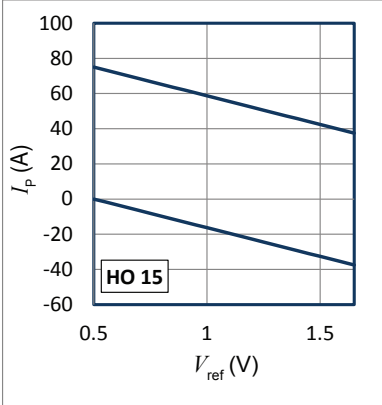

Upper limit:  $I_p = -32.81 \times V_{ref} + 91.3$  ( $V_{ref} = 0.5 \dots 1.65$  V)

Lower limit:  $I_p = -32.81 \times V_{ref} + 16.3$  ( $V_{ref} = 0.5 \dots 1.65$  V)

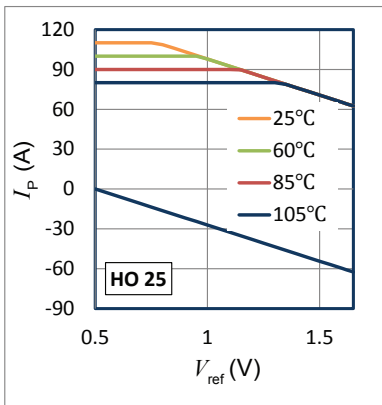

Upper limit:

$T_A = 105^\circ\text{C}$   $I_p = 80$  ( $V_{ref} = 0.5 \dots 1.328$  V)  
 $I_p = -54.35 \times V_{ref} + 152.17$  ( $V_{ref} = 1.328 \dots 1.65$  V)

$T_A = 85^\circ\text{C}$   $I_p = 90$  ( $V_{ref} = 0.5 \dots 1.144$  V)  
 $I_p = -54.35 \times V_{ref} + 152.17$  ( $V_{ref} = 1.144 \dots 1.65$  V)

$T_A = 80^\circ\text{C}$   $I_p = 100$  ( $V_{ref} = 0.5 \dots 0.96$  V)  
 $I_p = -54.35 \times V_{ref} + 152.17$  ( $V_{ref} = 0.96 \dots 1.65$  V)

$T_A = 25^\circ\text{C}$   $I_p = 110$  ( $V_{ref} = 0.5 \dots 0.776$  V)  
 $I_p = -54.35 \times V_{ref} + 152.17$  ( $V_{ref} = 0.776 \dots 1.65$  V)

Lower limit:  $I_p = -54.35 \times V_{ref} + 27.17$  ( $V_{ref} = 0.5 \dots 1.65$  V)

Example with  $V_{ref} = 0.5$  V:

- The 8 A version has a measuring range from 0 A to 40 A
- The 15 A version has a measuring range from 0 A to 75 A
- The 25 A version has a measuring range from 0 A to 80 A at  $T_A = 105^\circ\text{C}$

Example with  $V_{ref} = 1.5$  V:

- The 8 A version has a measuring range from -17.4 A to +22.6 A
- The 15 A version has a measuring range from -32.6 A to +42.4 A
- The 25 A version has a measuring range from -54.4 A to +70.6 A

## Application information

### Total primary resistance

The primary resistance is 0.36 mΩ per conductor at 25 °C.

In the following table, examples of primary resistance according to the number of primary turns.

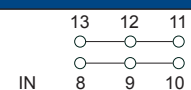
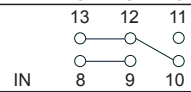
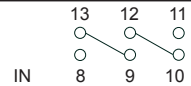
| Number of primary turns<br>$N_p$ | Resistance of primary (winding)<br>$R_p$ [ mΩ ] | Recommended connections   | Primary nominal RMS current<br>$I_{pN}$ [ A ] |     |      |
|----------------------------------|---|---|---|-----|------|
| 1                                | 0.12  |  | 8   | 15  | 25   |
| 2                                | 0.54  |  | 4   | 7.5 | 12.5 |
| 3                                | 1.18  |  | 2.67  | 5   | 8.33 |

### Definition of typical, minimum and maximum values

Minimum and maximum values for specified limiting and safety conditions have to be understood as such as well as values shown in “typical” graphs.

On the other hand, measured values are part of a statistical distribution that can be specified by an interval with upper and lower limits and a probability for measured values to lie within this interval.

Unless otherwise stated (e.g. “100 % tested”), the LEM definition for such intervals designated with “min” and “max” is that the probability for values of samples to lie in this interval is 99.73 %.

For a normal (Gaussian) distribution, this corresponds to an interval between -3 sigma and +3 sigma. If “typical” values are not obviously mean or average values, those values are defined to delimit intervals with a probability of 68.27 %, corresponding to an interval between -sigma and +sigma for a normal distribution.

Typical, maximal and minimal values are determined during the initial characterization of a product.

### HO-NSM/SP33 Series: name and codification

HO family products may be ordered **on request** <sup>1)</sup> with a dedicated setting of the parameters described below (standard products are delivered with the setting 1000 according to the table).

#### HO 15-NSM/SP33-XXXX

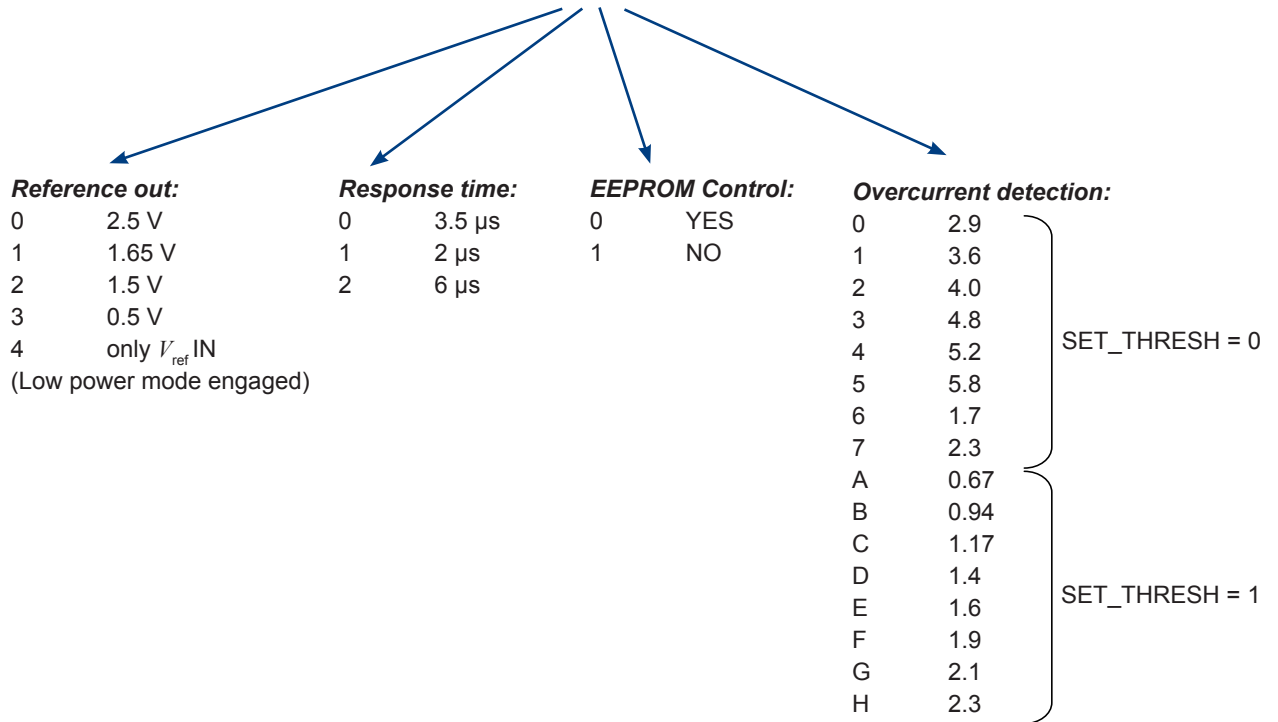

Standard products are:  
 - HO 8-NSM/SP33-1000  
 - HO 15-NSM/SP33-1000  
 - HO 25-NSM/SP33-1000

**Note:** <sup>1)</sup> For dedicated settings, minimum quantities apply.

### PCB footprint

(Example footprint) Top side view

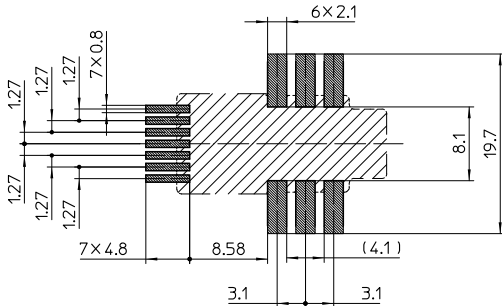

### Reflow profile

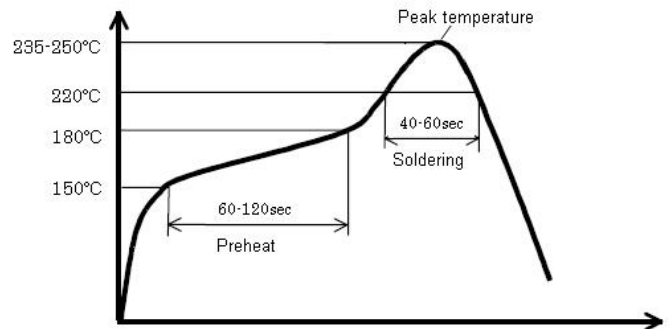

### Safety

This transducer must be used in limited-energy secondary circuits according to IEC 61010-1.



This transducer must be used in electric/electronic equipment with respect to applicable standards and safety requirements in accordance with the manufacturer's operating instructions.



Caution, risk of electrical shock

When operating the transducer, certain parts of the module can carry hazardous voltage (e.g. primary busbar, power supply). Ignoring this warning can lead to injury and/or cause serious damage.

This transducer is a build-in device, whose conducting parts must be inaccessible after installation.

A protective housing or additional shield could be used. Main supply must be able to be disconnected.

### Remark

Installation of the transducer must be done unless otherwise specified on the datasheet, according to LEM Transducer Generic Mounting Rules. Please refer to LEM document N°ANE120504 available on our Web site: [Products/Product Documentation](#).

**Dimensions** (in mm, general linear tolerance  $\pm 0.5$  mm)

Marking area:  
Model type  
Date code  
UL mark  
Current direction

**Connection**

|        | $d_{Cl}$ (mm) | $d_{Cp}$ (mm) |
|--------|---------------|---------------|
| note1) | 8.0           | 8.0           |

1) Minimum distance from the primary to the core