

Evaluation Board for CS4352

Features

- ◆ Demonstrates Recommended Layout And Grounding Arrangements
- ◆ CS8416 Receives S/PDIF, & EIAJ-340-Compatible Digital Audio
- ◆ Headers for External PCM Audio
- ◆ Requires Only a Digital Signal Source and Power Supplies for a Complete Digital-to-Analog Converter System

Description

The CDB4352 evaluation board is an excellent means for quickly evaluating the CS4352 24-bit, high-performance stereo D/A converter. Evaluation requires an analog signal analyzer, a digital signal source, and a power supply. Analog line-level outputs are provided via RCA phono jacks.

The CS8416 digital audio receiver IC provides the system timing necessary to operate the Digital-to-Analog converter and will accept S/PDIF and EIAJ-340-compatible audio data. The evaluation board may also be configured to accept external timing and data signals for operation in a user application during system development.

ORDERING INFORMATION

CDB4352

Evaluation Board

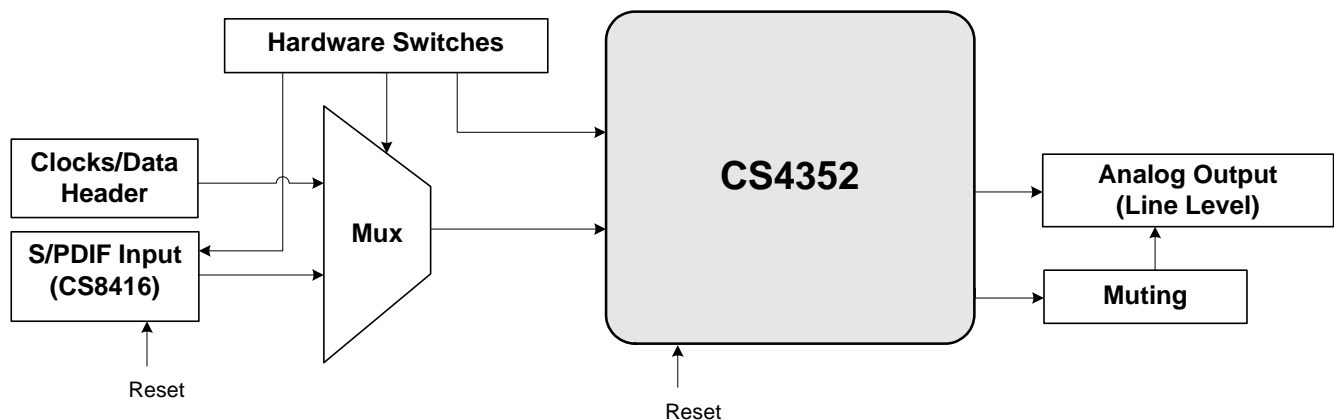

TABLE OF CONTENTS

1. CDB4352 SYSTEM OVERVIEW	4
2. CS4352 DIGITAL-TO-ANALOG CONVERTER	4
3. CS8416 DIGITAL AUDIO RECEIVER	4
4. INPUT FOR CLOCKS AND DATA	4
5. POWER SUPPLY CIRCUITRY	4
6. GROUNDING AND POWER SUPPLY DECOUPLING	5
7. HARDWARE CONTROL	5
8. ANALOG OUTPUT FILTERING	5
9. PERFORMANCE PLOTS	6
10. DESIGN NOTE	11
11. SCHEMATICS	12
12. REVISION HISTORY	21

LIST OF FIGURES

Figure 1. FFT (48 kHz, 0 dB)	6
Figure 2. FFT (48 kHz, -60 dB)	6
Figure 3. FFT (48 kHz, No Input)	6
Figure 4. FFT (48 kHz Out-of-Band, No Input)	6
Figure 5. 48 kHz, THD+N vs. Input Freq	6
Figure 6. 48 kHz, THD+N vs. Level	6
Figure 7. 48 kHz, Fade-to-Noise Linearity	7
Figure 8. 48 kHz, Frequency Response	7
Figure 9. 48 kHz, Crosstalk	7
Figure 10. 48 kHz, Impulse Response	7
Figure 11. FFT (96 kHz, 0 dB)	7
Figure 12. FFT (96 kHz, -60 dB)	7
Figure 13. FFT (96 kHz, No Input)	8
Figure 14. FFT (96 kHz Out-of-Band, No Input)	8
Figure 15. 96 kHz, THD+N vs. Input Freq	8
Figure 16. 96 kHz, THD+N vs. Level	8
Figure 17. 96 kHz, Fade-to-Noise Linearity	8
Figure 18. 96 kHz, Frequency Response	8
Figure 19. 96 kHz, Crosstalk	9
Figure 20. 96 kHz, Impulse Response	9
Figure 21. FFT (192 kHz, 0 dB)	9
Figure 22. FFT (192 kHz, -60 dB)	9
Figure 23. FFT (192 kHz, No Input)	9
Figure 24. FFT (192 kHz Out-of-Band, No Input)	9
Figure 25. 192 kHz, THD+N vs. Input Freq	10
Figure 26. 192 kHz, THD+N vs. Level	10
Figure 27. 192 kHz, Fade-to-Noise Linearity	10
Figure 28. 192 kHz, Frequency Response	10
Figure 29. 192 kHz, Crosstalk	10
Figure 30. 192 kHz, Impulse Response	10
Figure 31. System Block Diagram and Signal Flow	12
Figure 32. CS4352	13
Figure 33. Analog Outputs	14
Figure 34. PCM Input Headers	15
Figure 35. CS8416 S/PDIF Input	16
Figure 36. Power	17
Figure 37. Silkscreen Top	18

Figure 38. Top Side	19
Figure 39. Bottom Side	20

LIST OF TABLES

Table 1. System Connections	5
Table 2. CDB4352 Jumper Settings	11

1. CDB4352 SYSTEM OVERVIEW

The CDB4352 evaluation board is an excellent means of quickly evaluating the CS4352. The CS8416 digital audio interface receiver provides an easy interface to digital audio signal sources including the majority of digital audio test equipment. The evaluation board also allows the user to supply external PCM clocks and data through a header for system development.

The CDB4352 schematic has been partitioned into five schematics, as shown in [Figures 32 through 36](#). Each partitioned schematic is represented in the system diagram shown in [Figure 31](#). Notice that the system diagram also includes the interconnections between the partitioned schematics.

2. CS4352 DIGITAL-to-ANALOG CONVERTER

A description of the CS4352 is included in the CS4352 datasheet.

3. CS8416 DIGITAL AUDIO RECEIVER

The system receives and decodes the standard S/PDIF data format using a CS8416 Digital Audio Receiver, [Figure 35](#). The outputs of the CS8416 include a serial bit clock, serial data, left-right clock, and a 128/256 Fs master clock. The CS8416 data format is fixed to I²S. The operation of the CS8416 and a discussion of the digital audio interface is included in the CS8416 datasheet.

The evaluation board has been designed such that the input can be either optical or coaxial, see [Figure 35](#). However, both inputs cannot be driven simultaneously.

Position 2 of S1 sets the output MCLK to LRCK ratio of the CS8416. This switch should be set to 256 (LO) for input $F_s \leq 48$ kHz and can be either 256 (LO) or 128 (HI) for $F_s > 48$ kHz

4. INPUT FOR CLOCKS AND DATA

The evaluation board has been designed to allow interfacing to external systems via the header J13. Header J13 allows the evaluation board to accept externally generated PCM clocks and data. The schematic for the clock/data input is shown in [Figure 34](#). Switch position 1 of S1 selects the source as either CS8416 or header J13.

Please see the CS4352 datasheet for more information.

5. POWER SUPPLY CIRCUITRY

Power is supplied to the evaluation board by three binding posts (GND, VL, and VA_H), see [Figure 36](#). The VL supply can be jumpered to a +3.3 V regulator or provided externally through the VL binding post. VD and VA is normally supplied by the 3.3 V regulator but can be disconnected using J4 and J6 and then have external voltage applied to the VD and VA test points. The +5 V supply (which powers the regulators for this board) is normally supplied by a 5 V regulator but can be supplied externally by removing J7 and applying 5 V to TP8.

Power consumption of the CS4352 can be measured through the voltage drop at J8, J9, J10, and J11 when the shunts are removed.

WARNING: Refer to the CS4352 datasheet for maximum allowable voltages levels. Operation outside of this range can cause permanent damage to the device.

6. GROUNDING AND POWER SUPPLY DECOUPLING

As with any high-performance converter, the CS4352 requires careful attention to power supply and grounding arrangements to optimize performance. [Figure 32](#) details the connections to the CS4352 and [Figures 37, 38, and 39](#) show the component placement and top and bottom layout. The decoupling capacitors are located as close to the CS4352 as possible. Extensive use of ground plane fill in the evaluation board yields large reductions in radiated noise.

7. HARDWARE CONTROL

The CDB4352 is controlled through settings on switch S1. This allows for configuration of the board without a PC. A switch is provided for CS8416 MCLK speed, clock and data source for the board, and the hardware mode configuration of the CS4352.

8. ANALOG OUTPUT FILTERING

The analog output on the CDB4352 has been designed according to the CS4352 datasheet. This output circuit includes an AC coupling cap, the BJT mute circuit, and a single-pole R and C.

CONNECTOR	INPUT/OUTPUT	SIGNAL PRESENT
VL	Input	+ 1.5 V to +3.3 V power for the CS4352 serial interface
VA_H	Input	+9 V to +12 V positive supply for the CS4352 high-voltage analog and the CDB4352 regulators
GND	Input	Ground connection from power supply
SPDIF INPUT - J16	Input	Digital audio interface input via coaxial cable
SPDIF INPUT - OPT1	Input	Digital audio interface input via optical cable
PCM INPUT - J13	Input	Input for master, serial, left/right clocks and serial data
AOUTA and AOUTB	Output	RCA line-level analog outputs

Table 1. System Connections

9. PERFORMANCE PLOTS

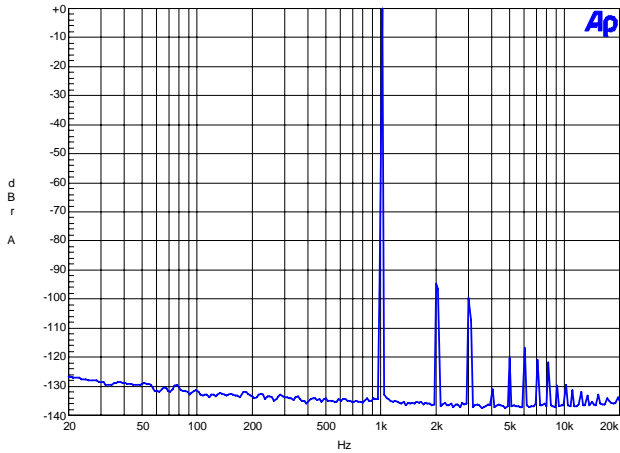

Figure 1. FFT (48 kHz, 0 dB)

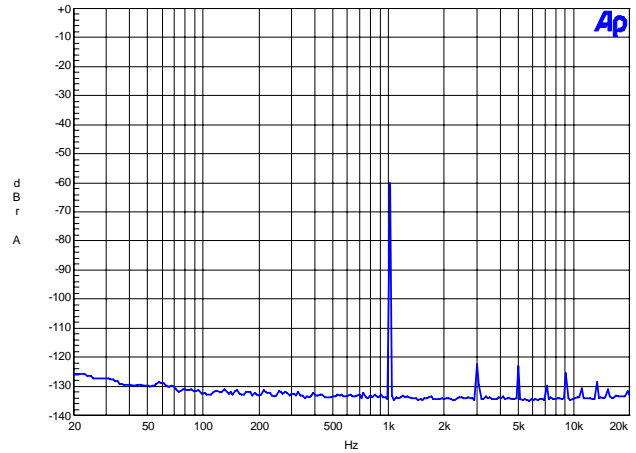

Figure 2. FFT (48 kHz, -60 dB)

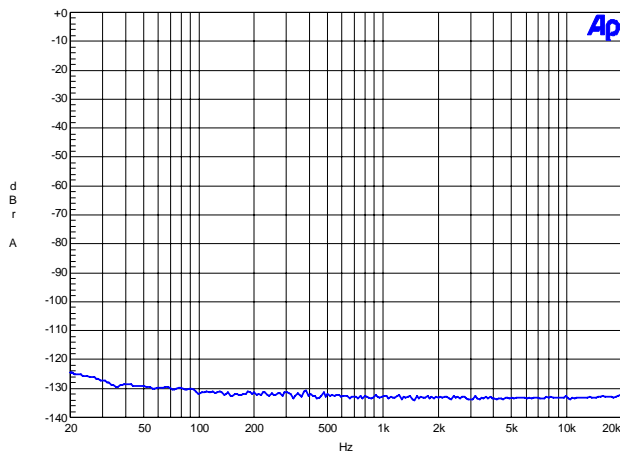

Figure 3. FFT (48 kHz, No Input)

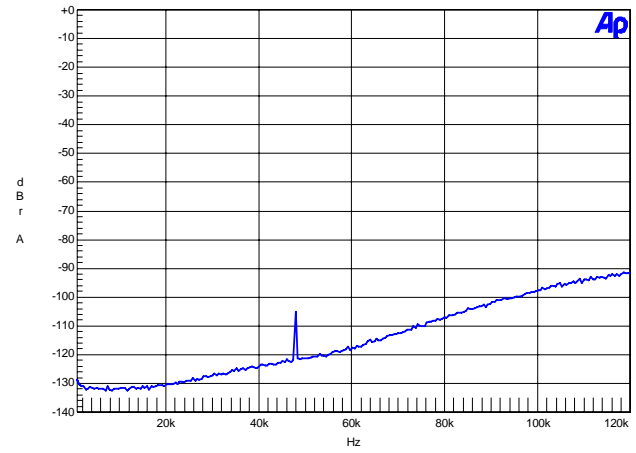

Figure 4. FFT (48 kHz Out-of-Band, No Input)

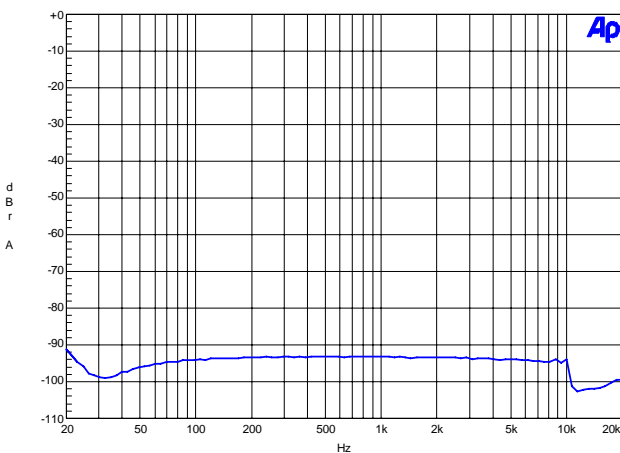

Figure 5. 48 kHz, THD+N vs. Input Freq

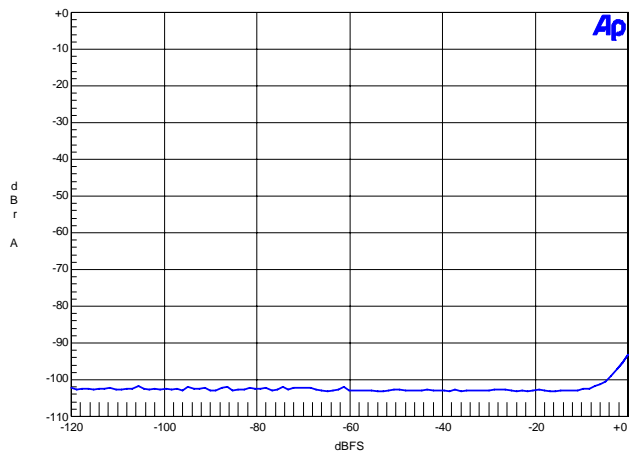
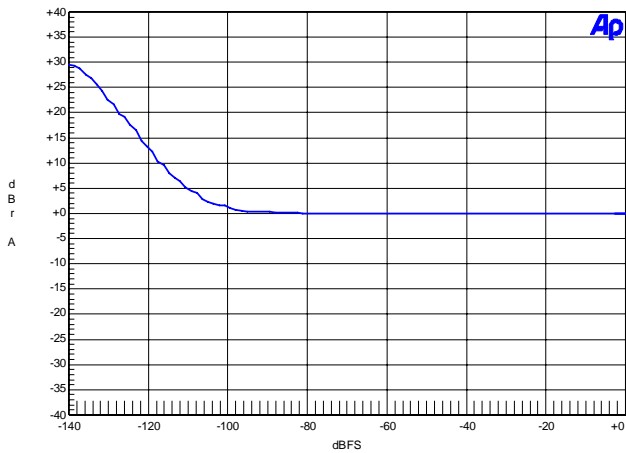
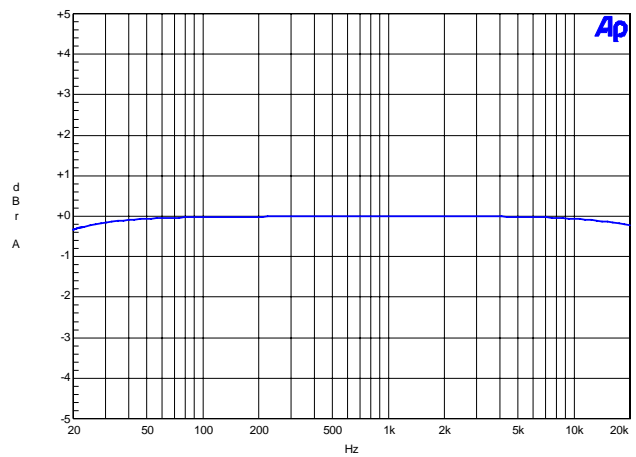
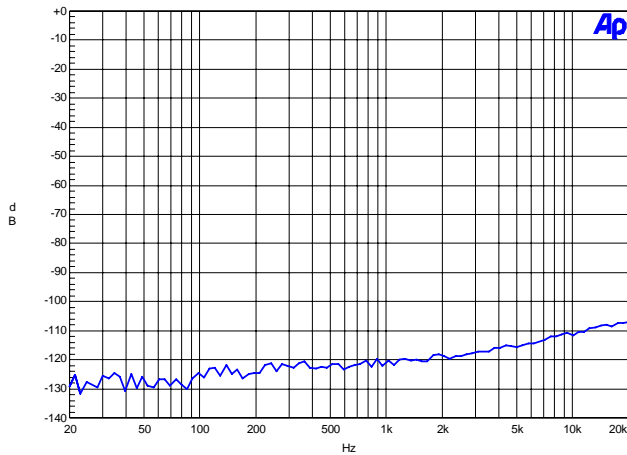
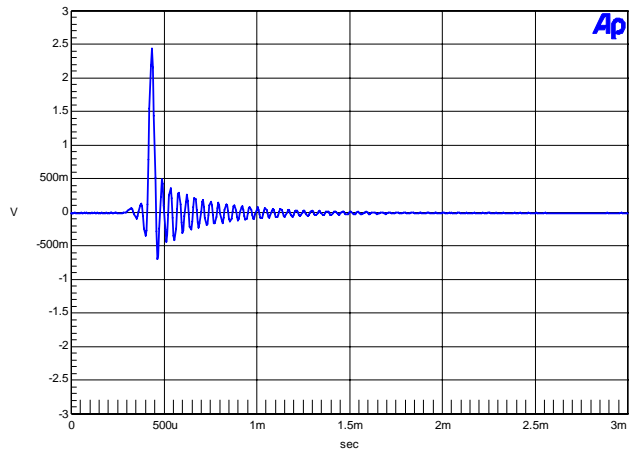
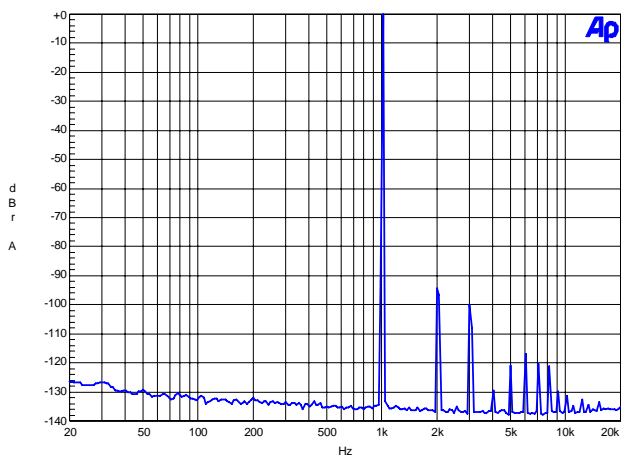
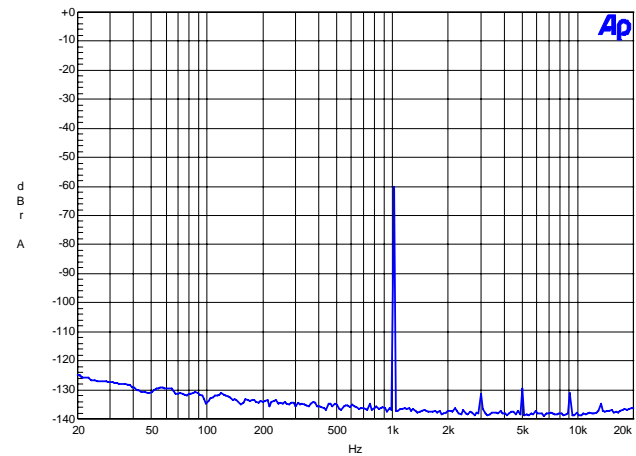
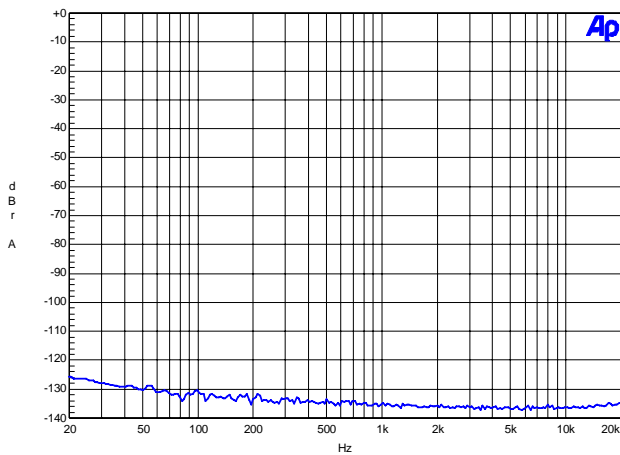
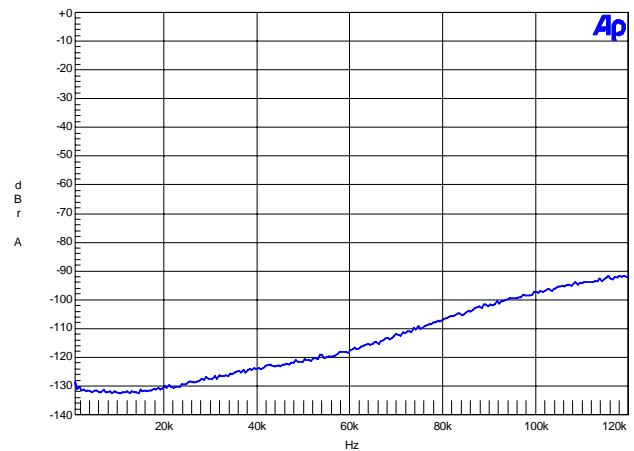
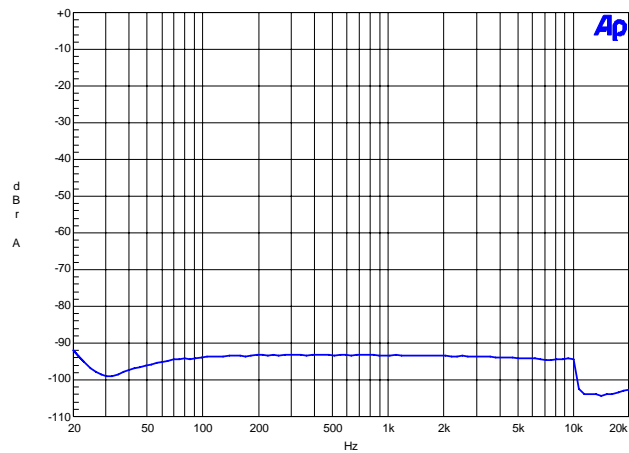
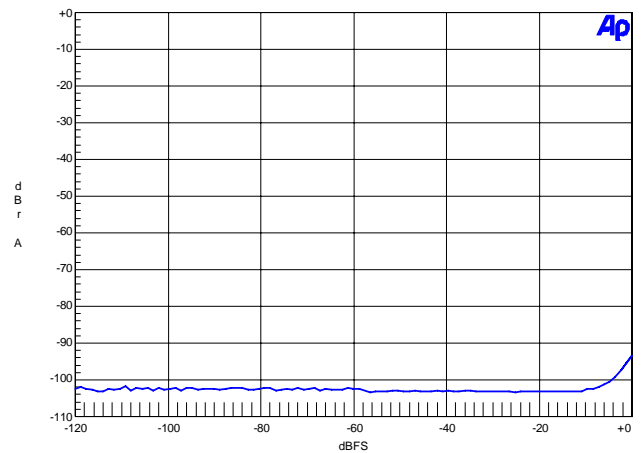
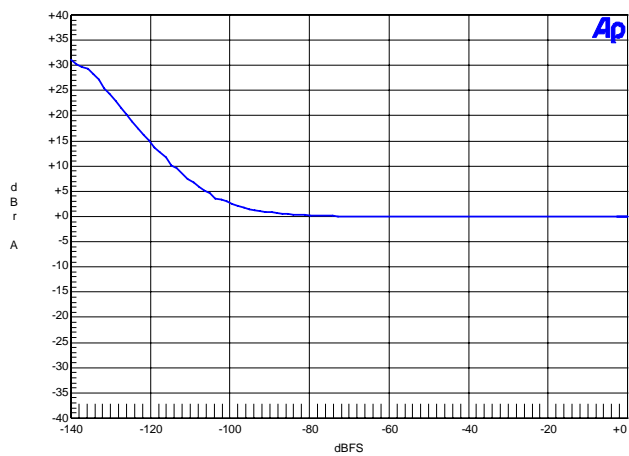
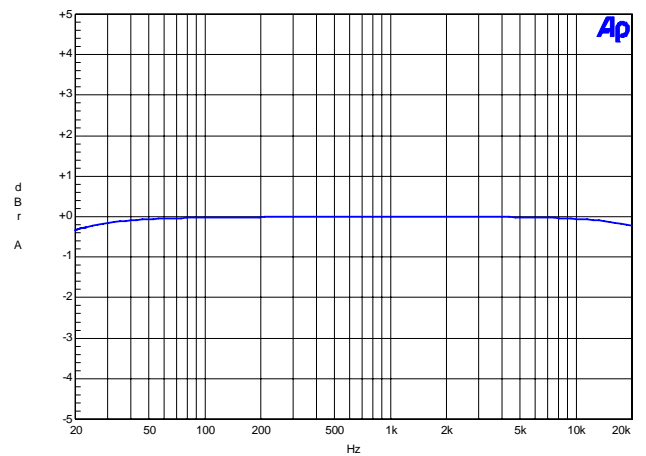
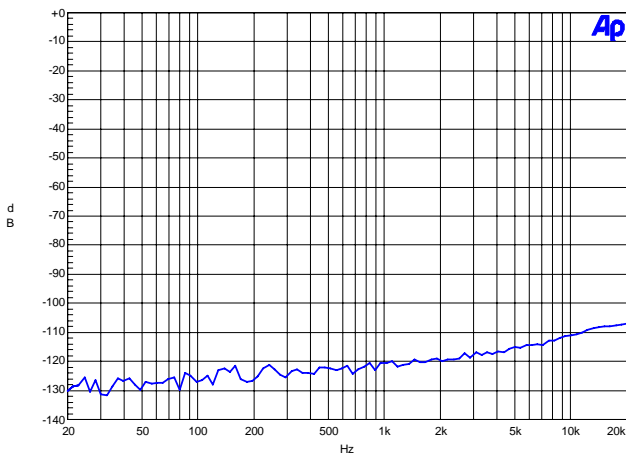
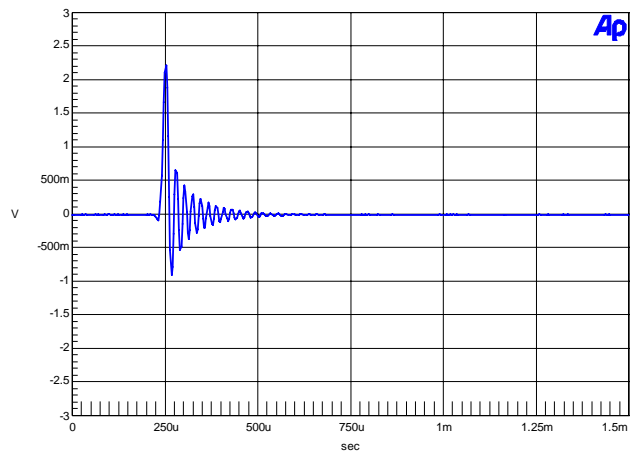
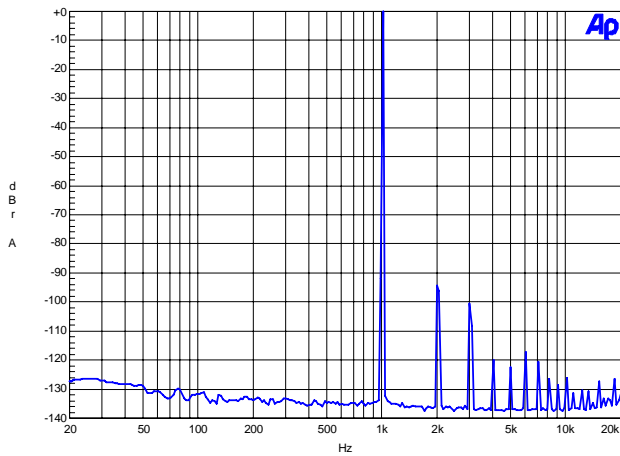
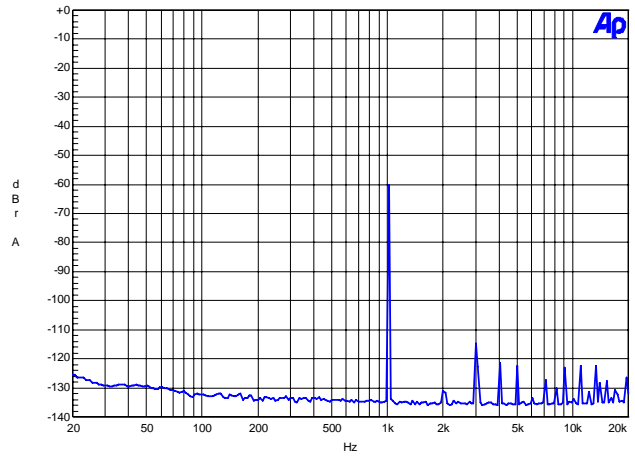
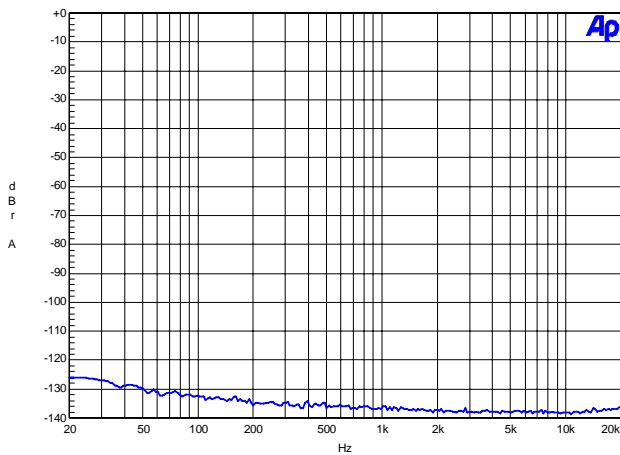
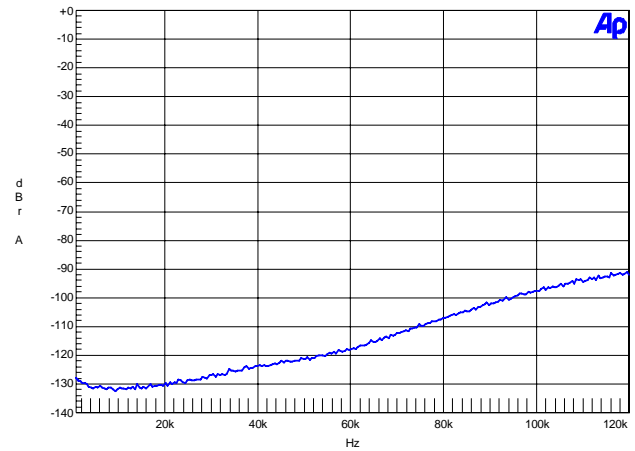
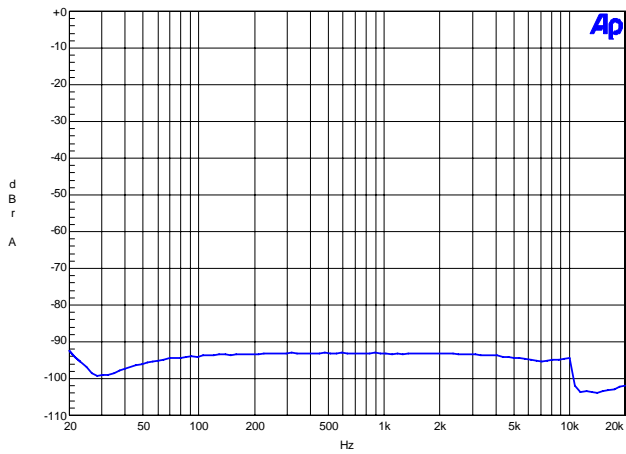
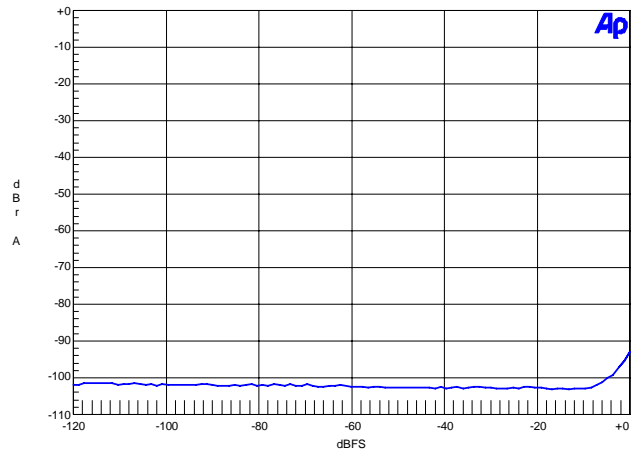
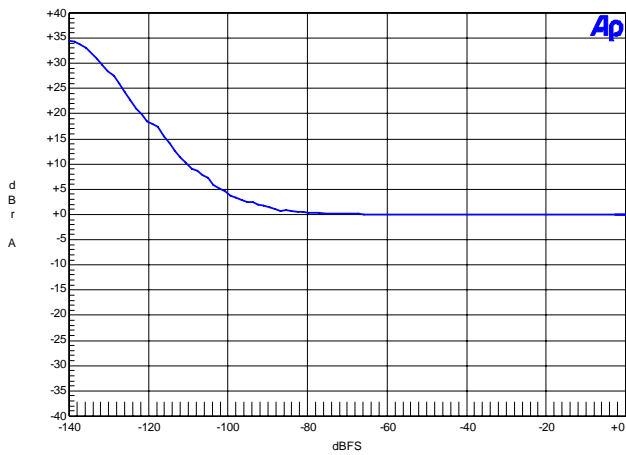
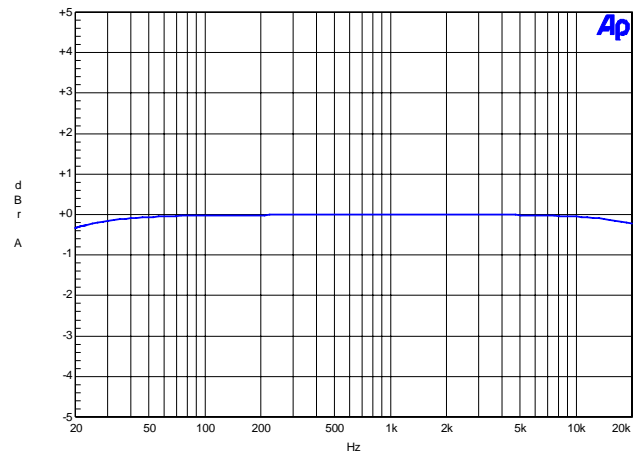
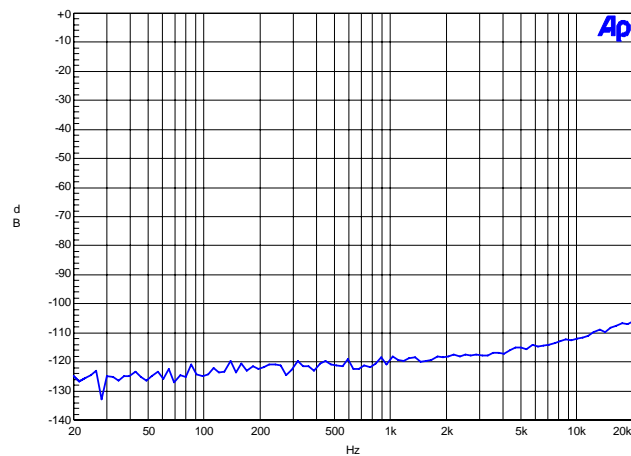
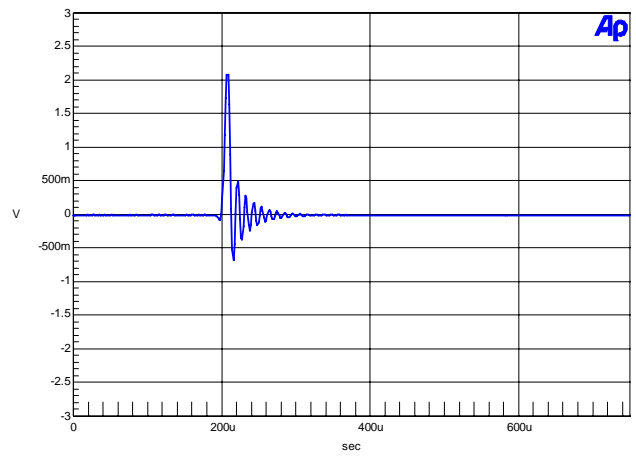

Figure 6. 48 kHz, THD+N vs. Level

Figure 7. 48 kHz, Fade-to-Noise Linearity

Figure 8. 48 kHz, Frequency Response

Figure 9. 48 kHz, Crosstalk

Figure 10. 48 kHz, Impulse Response

Figure 11. FFT (96 kHz, 0 dB)

Figure 12. FFT (96 kHz, -60 dB)

Figure 13. FFT (96 kHz, No Input)

Figure 14. FFT (96 kHz Out-of-Band, No Input)

Figure 15. 96 kHz, THD+N vs. Input Freq

Figure 16. 96 kHz, THD+N vs. Level

Figure 17. 96 kHz, Fade-to-Noise Linearity

Figure 18. 96 kHz, Frequency Response

Figure 19. 96 kHz, Crosstalk

Figure 20. 96 kHz, Impulse Response

Figure 21. FFT (192 kHz, 0 dB)

Figure 22. FFT (192 kHz, -60 dB)

Figure 23. FFT (192 kHz, No Input)

Figure 24. FFT (192 kHz Out-of-Band, No Input)

Figure 25. 192 kHz, THD+N vs. Input Freq

Figure 26. 192 kHz, THD+N vs. Level

Figure 27. 192 kHz, Fade-to-Noise Linearity

Figure 28. 192 kHz, Frequency Response

Figure 29. 192 kHz, Crosstalk

Figure 30. 192 kHz, Impulse Response

JUMPER / SWITCH	PURPOSE	POSITION	FUNCTION SELECTED
J7	Selects source of voltage for the +5V supplies	+5 V *+5V_REG	Voltage source is +5 V test point (TP8) Voltage source is +5 V regulator
J4	Selects source of voltage for the VD supplies	VD *+3.3V REG	Voltage source is VD test point (TP2) Voltage source is +3.3 V regulator
J5	Selects source of voltage for the VL supply	VL *+3.3V REG	Voltage source is VL binding post Voltage source is +3.3 V regulator
J6	Selects source of voltage for the VA supply	VA *+3.3V REG	Voltage source is VA test point (TP7) Voltage source is +3.3 V regulator
J8	Current measure for VD	*shunted	When shunt is removed, the voltage can be measured across a fixed resistance to determine current.
J9	Current measure for VL	*shunted	When shunt is removed, the voltage can be measured across a fixed resistance to determine current.
J10	Current measure for VA	*shunted	When shunt is removed, the voltage can be measured across a fixed resistance to determine current.
J11	Current measure for VA_H	*shunted	When shunt is removed, the voltage can be measured across a fixed resistance to determine current.
S1	Sets clock source, CS8416 clock speed, and CS4352 settings	*1 = open *2, 3, 4, 5 = closed	position 1: 0 = external clock source, 1 = CS8416 position 2: 0 = 8416 MCLK is 256x Fs, 1 = 128x Fs Position 3,4,5: see CS4352 datasheet
S2	Reset	-	Enables reset for CS4352 and CS8416 when pressed
J12 J17	Mute Disable	*LED MUTE	Bypasses muting to turn on LED Normal muting circuit

Table 2. CDB4352 Jumper Settings

*Default Factory Settings.

10.DESIGN NOTE

10.1 CDB4352 Revision A.0

D2 has been removed and shorted and R2 has been removed.

The serial audio decode table for S1 is incorrect. '01' should be RJ-24 and '10' should be LJ

The polarity of the silkscreen for Z1, Z2, Z3, Z4, and Z5 is incorrect

The CS4352 revision is A1

10.2 CDB4352 Revision B.0

No errors at this time

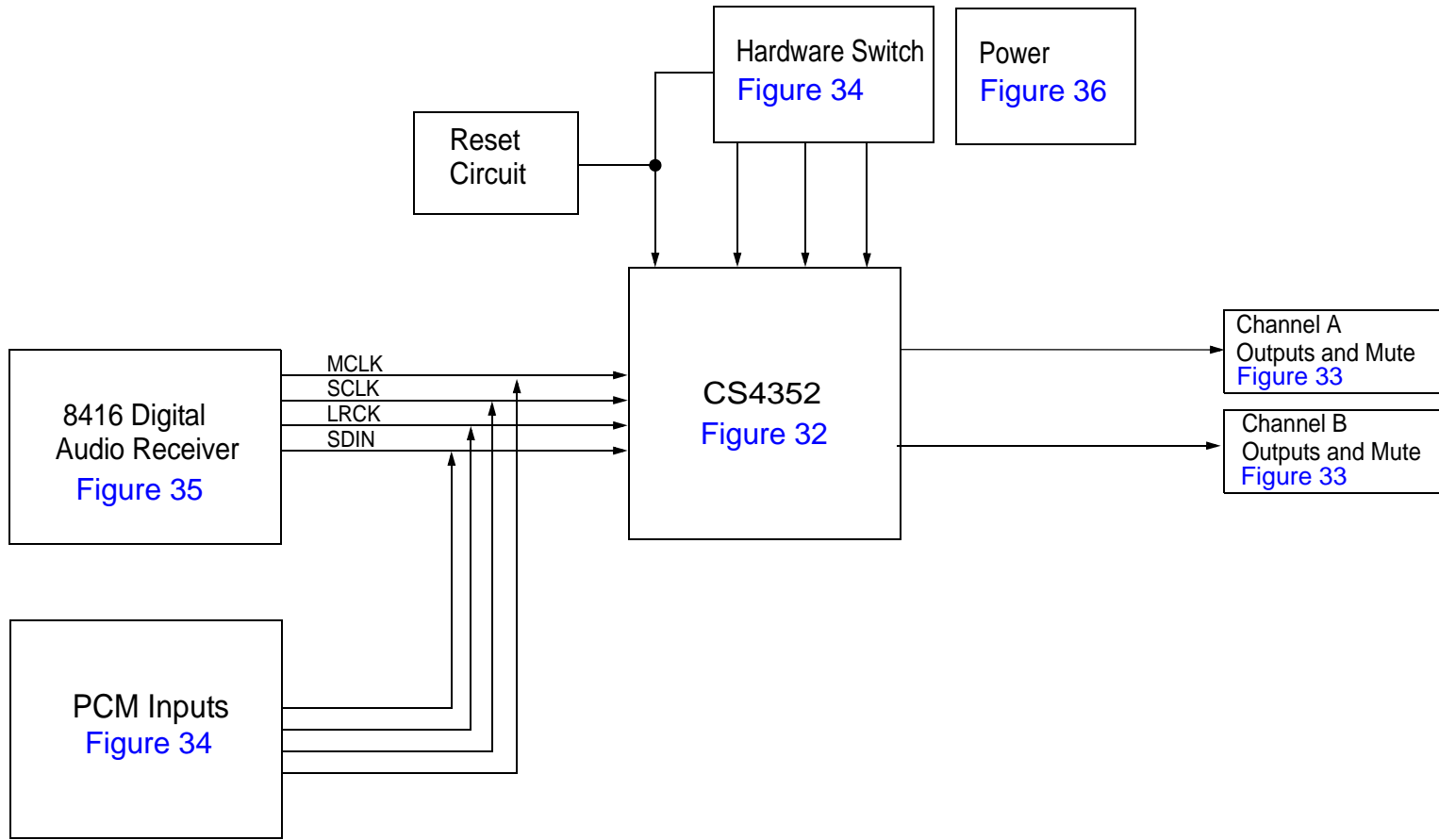

Figure 31. System Block Diagram and Signal Flow

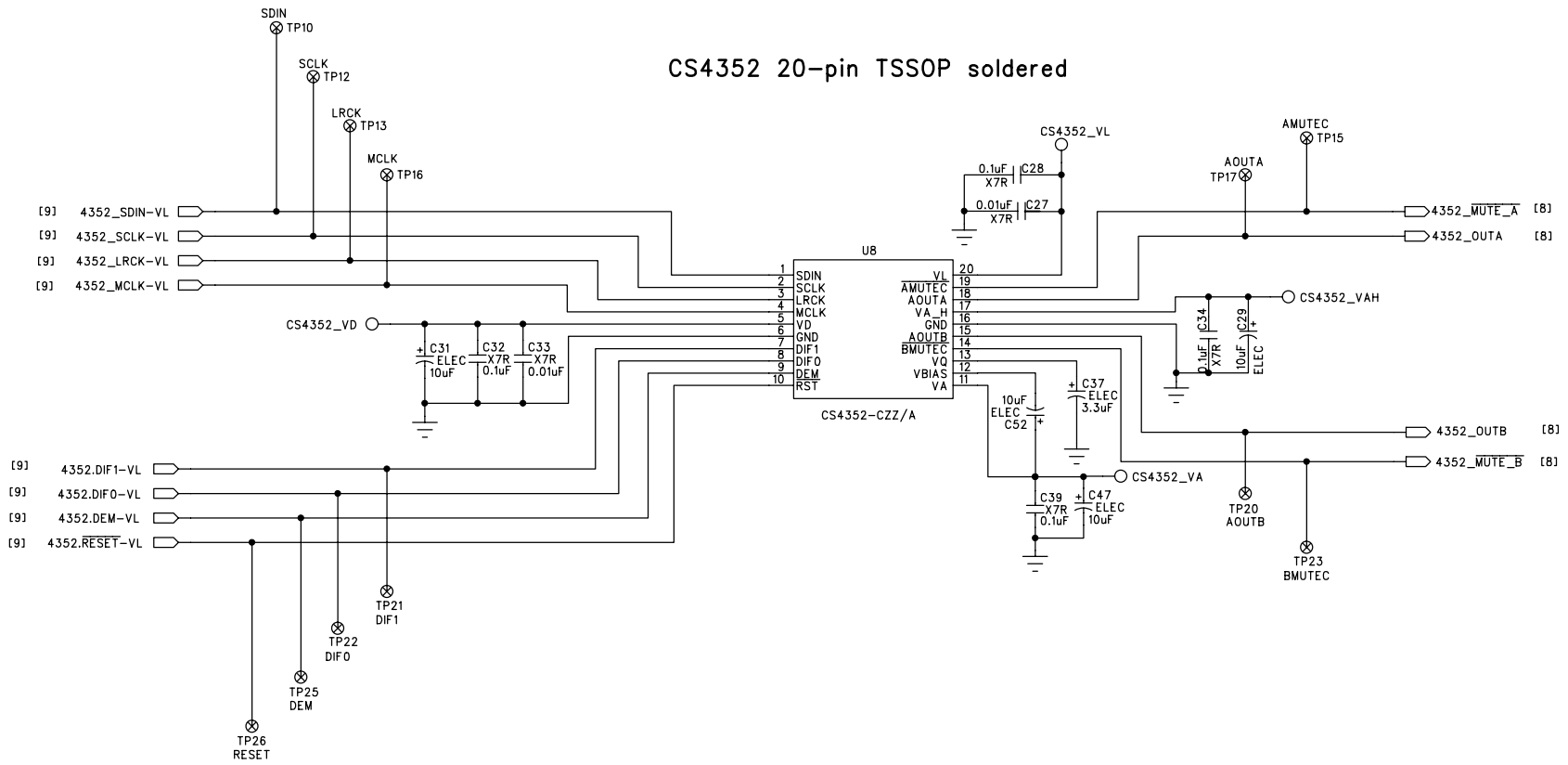

Figure 32. CS4352

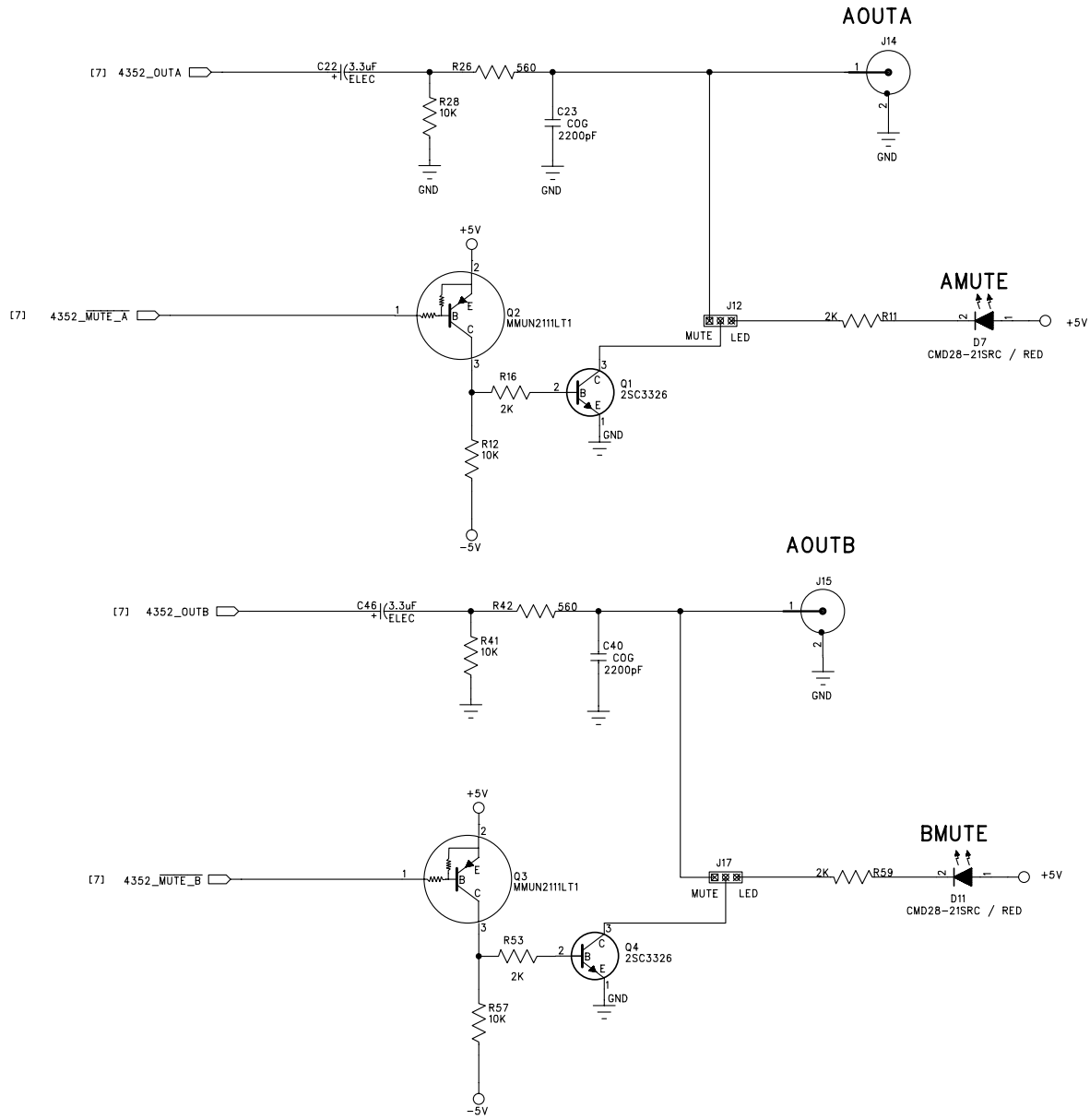
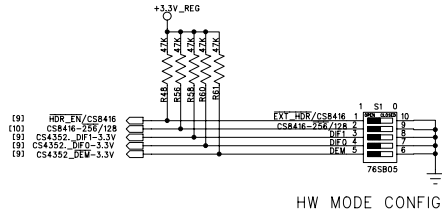

Figure 33. Analog Outputs



S5 BOARD HW CONFIG

FUNCTION	SWITCH	0/1	MODE
SAI source	1	0	EXT HDR
8416 MCLK	2	0*	8416
		1	256
SAI format	3:4	00*	I2S
		01	LJ
		10	RJ-24
		11	RJ-16
DE-EMPH	5	0*	OFF
		1	ON

* denotes default setting

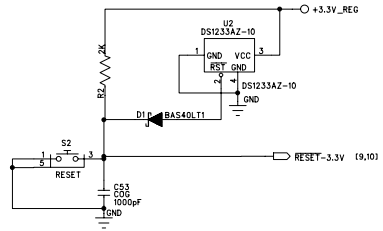

PCM Input Header Clock/Data Mux and Level Shift

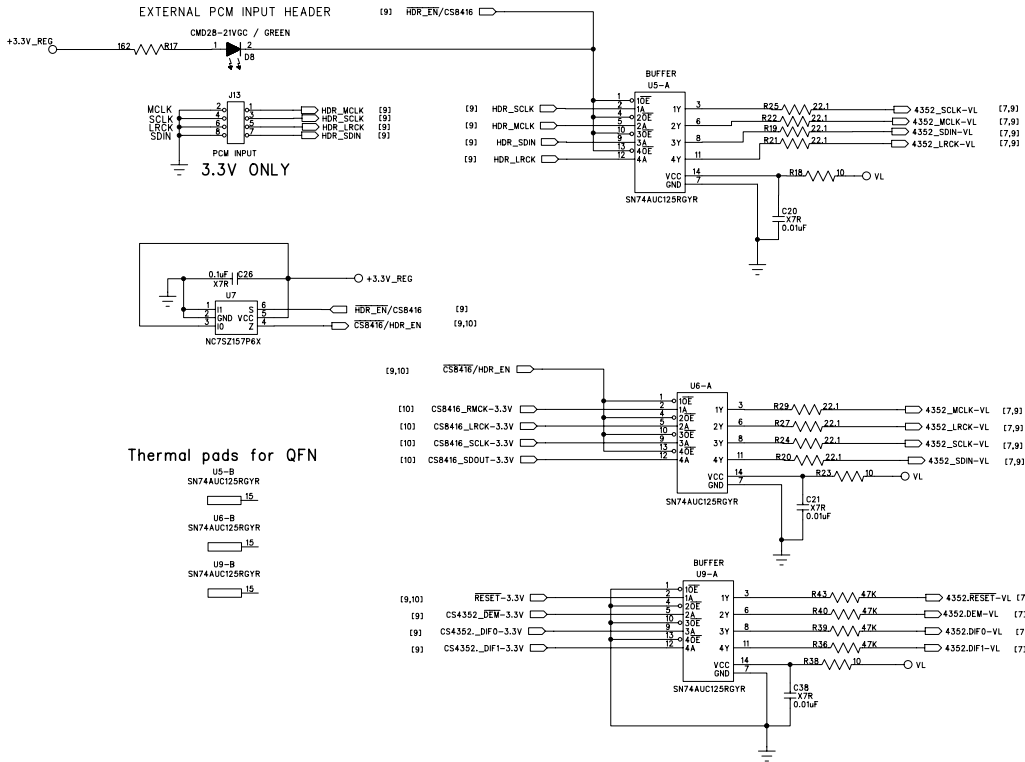

Figure 34. PCM Input Headers



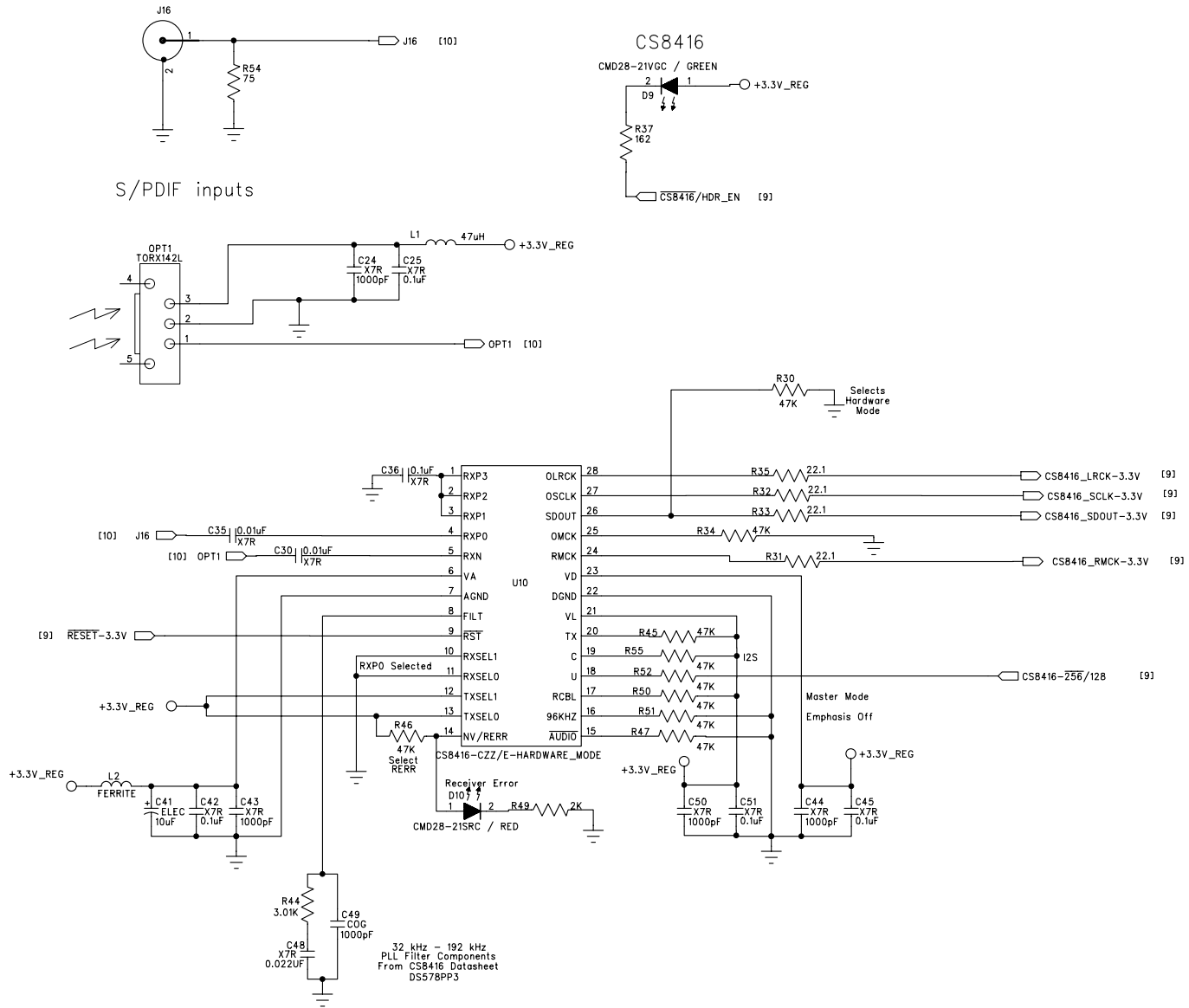

Figure 35. CS8416 S/PDIF Input



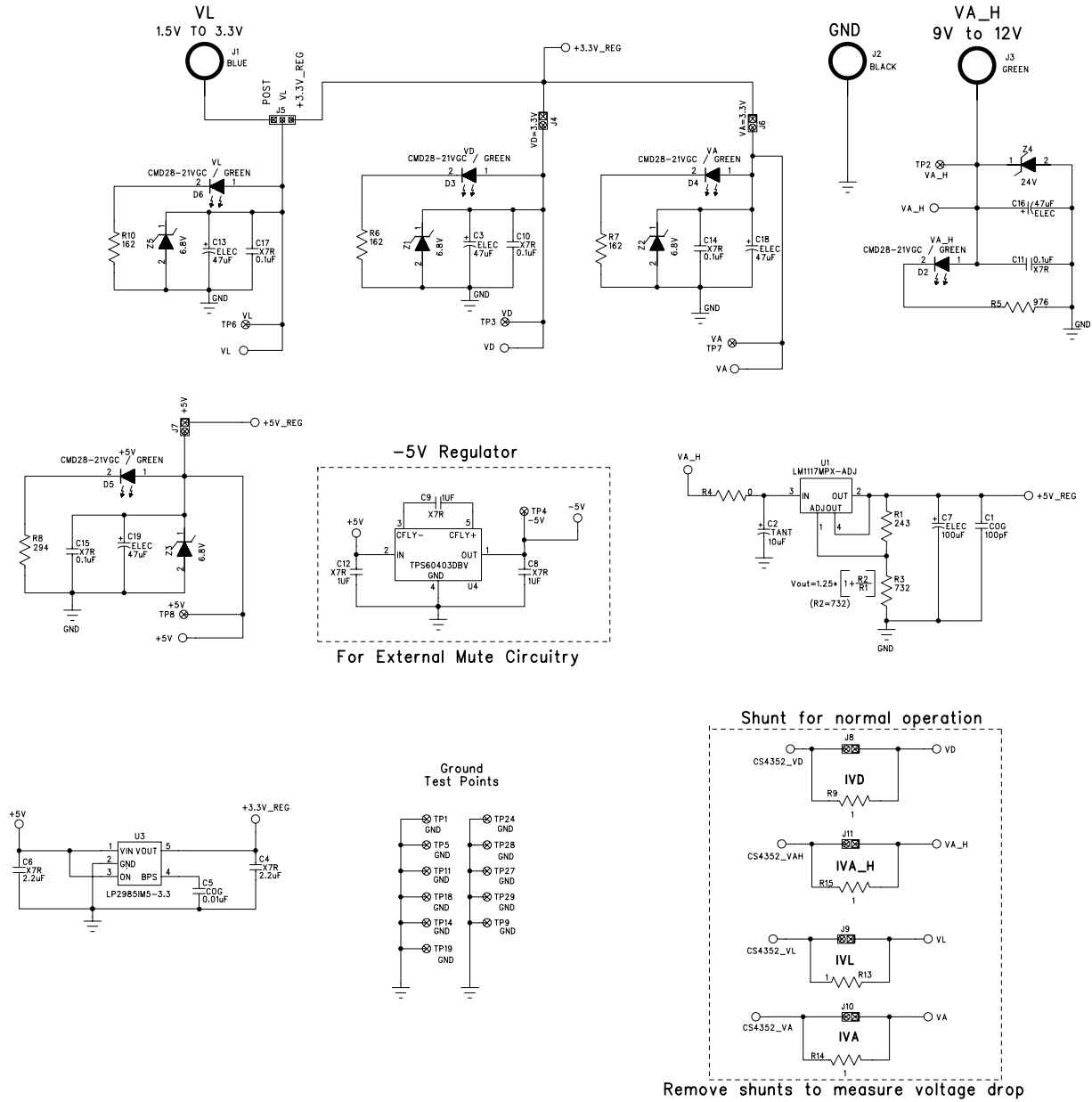

Figure 36. Power



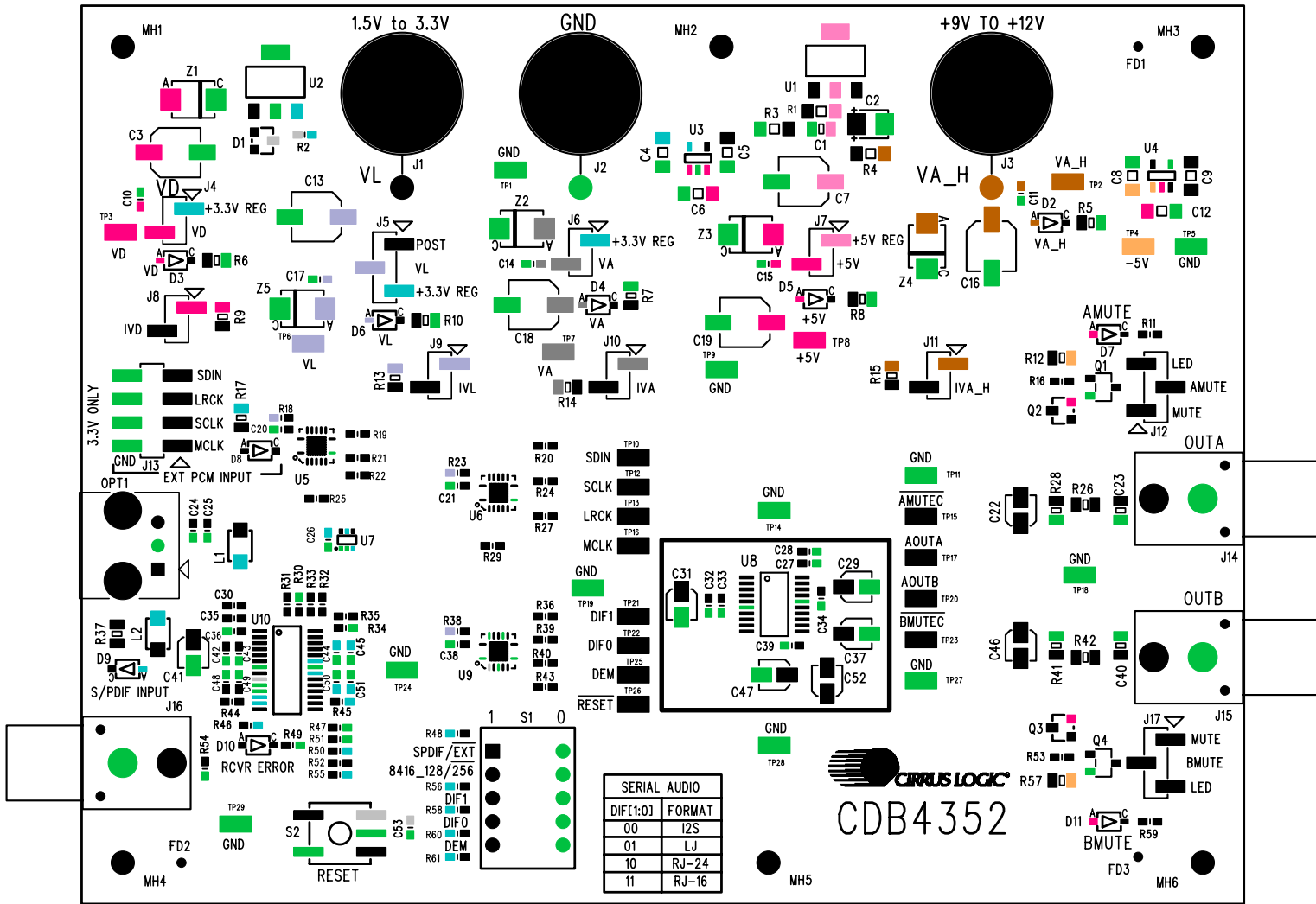

Figure 37. Silkscreen Top



CIRUS LOGIC

CDB4352



CIRUS LOGIC®

CDB4352

7

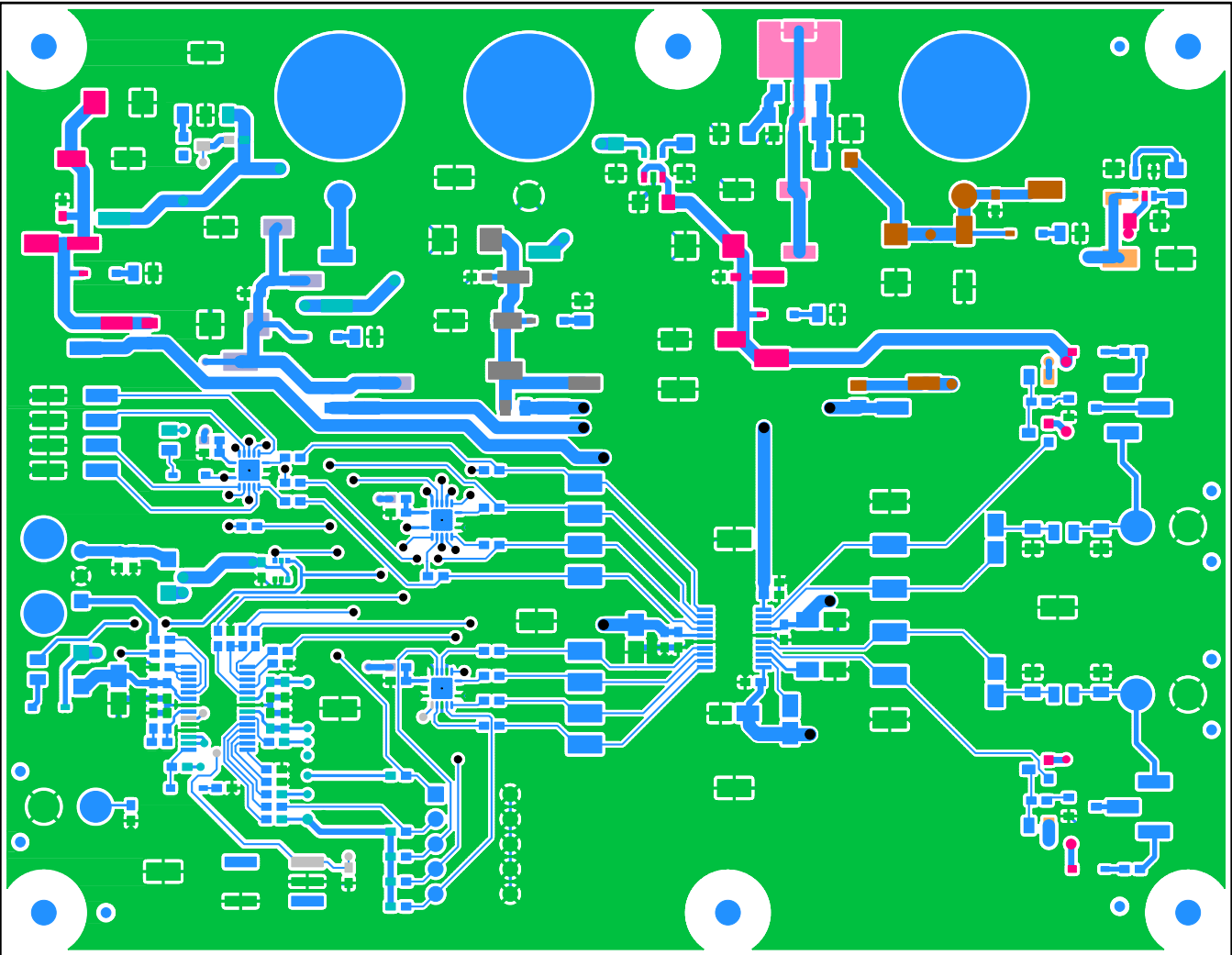

Figure 38. Top Side

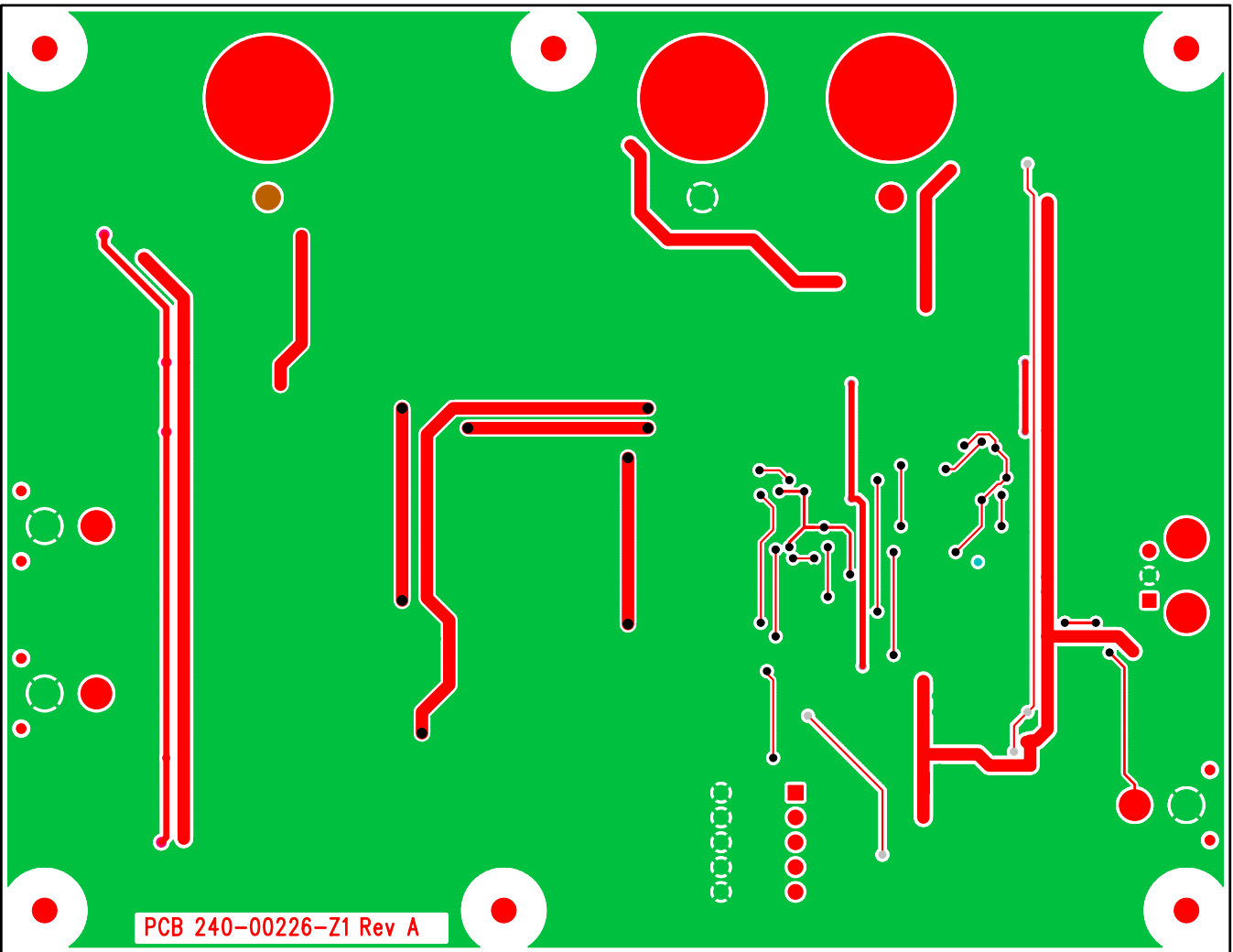

Figure 39. Bottom Side

12. REVISION HISTORY

Release	Changes
DB1	Initial Release
DB2	Added Performance Plots

Contacting Cirrus Logic Support

For all product questions and inquiries, contact a Cirrus Logic Sales Representative.

To find the one nearest you, go to www.cirrus.com.

IMPORTANT NOTICE

Cirrus Logic, Inc. and its subsidiaries ("Cirrus") believe that the information contained in this document is accurate and reliable. However, the information is subject to change without notice and is provided "AS IS" without warranty of any kind (express or implied). Customers are advised to obtain the latest version of relevant information to verify, before placing orders, that information being relied on is current and complete. All products are sold subject to the terms and conditions of sale supplied at the time of order acknowledgment, including those pertaining to warranty, indemnification, and limitation of liability. No responsibility is assumed by Cirrus for the use of this information, including use of this information as the basis for manufacture or sale of any items, or for infringement of patents or other rights of third parties. This document is the property of Cirrus and by furnishing this information, Cirrus grants no license, express or implied under any patents, mask work rights, copyrights, trademarks, trade secrets or other intellectual property rights. Cirrus owns the copyrights associated with the information contained herein and gives consent for copies to be made of the information only for use within your organization with respect to Cirrus integrated circuits or other products of Cirrus. This consent does not extend to other copying such as copying for general distribution, advertising or promotional purposes, or for creating any work for resale.

CERTAIN APPLICATIONS USING SEMICONDUCTOR PRODUCTS MAY INVOLVE POTENTIAL RISKS OF DEATH, PERSONAL INJURY, OR SEVERE PROPERTY OR ENVIRONMENTAL DAMAGE ("CRITICAL APPLICATIONS"). CIRRUS PRODUCTS ARE NOT DESIGNED, AUTHORIZED OR WARRANTED FOR USE IN AIRCRAFT SYSTEMS, MILITARY APPLICATIONS, PRODUCTS SURGICALLY IMPLANTED INTO THE BODY, AUTOMOTIVE SAFETY OR SECURITY DEVICES, LIFE SUPPORT PRODUCTS OR OTHER CRITICAL APPLICATIONS. INCLUSION OF CIRRUS PRODUCTS IN SUCH APPLICATIONS IS UNDERSTOOD TO BE FULLY AT THE CUSTOMER'S RISK AND CIRRUS DISCLAIMS AND MAKES NO WARRANTY, EXPRESS, STATUTORY OR IMPLIED, INCLUDING THE IMPLIED WARRANTIES OF MERCHANTABILITY AND FITNESS FOR PARTICULAR PURPOSE, WITH REGARD TO ANY CIRRUS PRODUCT THAT IS USED IN SUCH A MANNER. IF THE CUSTOMER OR CUSTOMER'S CUSTOMER USES OR PERMITS THE USE OF CIRRUS PRODUCTS IN CRITICAL APPLICATIONS, CUSTOMER AGREES, BY SUCH USE, TO FULLY INDEMNIFY CIRRUS, ITS OFFICERS, DIRECTORS, EMPLOYEES, DISTRIBUTORS AND OTHER AGENTS FROM ANY AND ALL LIABILITY, INCLUDING ATTORNEYS' FEES AND COSTS, THAT MAY RESULT FROM OR ARISE IN CONNECTION WITH THESE USES.

Cirrus Logic, Cirrus, and the Cirrus Logic logo designs are trademarks of Cirrus Logic, Inc. All other brand and product names in this document may be trademarks or service marks of their respective owners.