

User's Manual

78K0 - Shine It!

Demonstration Board for NEC Electronics μ PD78f8024 High-Current- Drive/LED Microcontroller

- **The information in this document is current as of June, 2008. The information is subject to change without notice. For actual design-in, refer to the latest publications of NEC Electronics data sheets or data books, etc., for the most up-to-date specifications of NEC Electronics products. Not all products and/or types are available in every country. Please check with an NEC Electronics sales representative for availability and additional information.**
- No part of this document may be copied or reproduced in any form or by any means without the prior written consent of NEC Electronics. NEC Electronics assumes no responsibility for any errors that may appear in this document.
- NEC Electronics does not assume any liability for infringement of patents, copyrights or other intellectual property rights of third parties by or arising from the use of NEC Electronics products listed in this document or any other liability arising from the use of such products. No license, express, implied or otherwise, is granted under any patents, copyrights or other intellectual property rights of NEC Electronics or others.
- Descriptions of circuits, software and other related information in this document are provided for illustrative purposes in semiconductor product operation and application examples. The incorporation of these circuits, software and information in the design of a customer's equipment shall be done under the full responsibility of the customer. NEC Electronics assumes no responsibility for any losses incurred by customers or third parties arising from the use of these circuits, software and information.
- While NEC Electronics endeavors to enhance the quality, reliability and safety of NEC Electronics products, customers agree and acknowledge that the possibility of defects thereof cannot be eliminated entirely. To minimize risks of damage to property or injury (including death) to persons arising from defects in NEC Electronics products, customers must incorporate sufficient safety measures in their design, such as redundancy, fire-containment and anti-failure features.
- NEC Electronics products are classified into the following three quality grades: "Standard", "Special" and "Specific".
The "Specific" quality grade applies only to NEC Electronics products developed based on a customer-designated "quality assurance program" for a specific application. The recommended applications of an NEC Electronics product depend on its quality grade, as indicated below. Customers must check the quality grade of each NEC Electronics product before using it in a particular application.
"Standard": Computers, office equipment, communications equipment, test and measurement equipment, audio and visual equipment, home electronic appliances, machine tools, personal electronic equipment and industrial robots.
"Special": Transportation equipment (automobiles, trains, ships, etc.), traffic control systems, anti-disaster systems, anti-crime systems, safety equipment and medical equipment (not specifically designed for life support).
"Specific": Aircraft, aerospace equipment, submersible repeaters, nuclear reactor control systems, life support systems and medical equipment for life support, etc.

The quality grade of NEC Electronics products is "Standard" unless otherwise expressly specified in NEC Electronics data sheets or data books, etc. If customers wish to use NEC Electronics products in applications not intended by NEC Electronics, they must contact an NEC Electronics sales representative in advance to determine NEC Electronics' willingness to support a given application.

(Note)

(1) "NEC Electronics" as used in this statement means NEC Electronics Corporation and also includes its majority-owned subsidiaries.

(2) "NEC Electronics products" means any product developed or manufactured by or for NEC Electronics (as defined above).

M8E 02. 11-1

CAUTION

This is a Test- and Measurement equipment with possibility to be significantly altered by user through hardware enhancements/modifications and/or test or application software. Thus, with respect to Council Directive 89/336/EEC (Directive on compliance with the EMC protection requirements), this equipment has no autonomous function. Consequently this equipment is not marked by the CE-symbol.

EEDT-ST-005-10

CAUTION

This equipment should be handled like a CMOS semiconductor device. The user must take all precautions to avoid build-up of static electricity while working with this equipment. All test and measurement tool including the workbench must be grounded. The user/operator must be grounded using the wrist strap. The connectors and/or device pins should not be touched with bare hands.

EEDT-ST-004-10

For customers in the European Union only

Redemption of Waste Electrical and Electronic Equipment (WEEE) in accordance with legal regulations applicable in the European Union only: This equipment (including all accessories) is not intended for household use. After use the equipment cannot be disposed of as household waste. NEC Electronics (Europe) GmbH offers to take back the equipment. All you need to do is register at <http://www.eu.necel.com/weee>

Regional Information

Some information contained in this document may vary from country to country. Before using any NEC product in your application, please contact the NEC office in your country to obtain a list of authorized representatives and distributors. They will verify:

- Device availability
- Ordering information
- Product release schedule
- Availability of related technical literature
- Development environment specifications (for example, specifications for third-party tools and components, host computers, power plugs, AC supply voltages, and so forth)
- Network requirements

In addition, trademarks, registered trademarks, export restrictions, and other legal issues may also vary from country to country.

NEC Electronics Inc. (U.S.)

Santa Clara, California
Tel: 408-588-6000
800-366-9782
Fax: 408-588-6130
800-729-9288

NEC Electronics Hong Kong Ltd.

Hong Kong
Tel: 2886-9318
Fax: 2886-9022/9044

NEC Electronics (Europe) GmbH

Duesseldorf, Germany
Tel: 0211-65 03 0
Fax: 0211-65 03 1327

NEC Electronics Hong Kong Ltd.

Seoul Branch
Seoul, Korea
Tel: 02-528-0303
Fax: 02-528-4411

Sucursal en España

Madrid, Spain
Tel: 091- 504 27 87
Fax: 091- 504 28 60

NEC Electronics Singapore Pte. Ltd.

Singapore
Tel: 65-6253-8311
Fax: 65-6250-3583

Succursale Française

Vélizy-Villacoublay, France
Tel: 01-30-67 58 00
Fax: 01-30-67 58 99

NEC Electronics Taiwan Ltd.

Taipei, Taiwan
Tel: 02-2719-2377
Fax: 02-2719-5951

Filiale Italiana

Milano, Italy
Tel: 02-66 75 41
Fax: 02-66 75 42 99

NEC do Brasil S.A.

Electron Devices Division
Guarulhos, Brasil
Tel: 55-11-6465-6810
Fax: 55-11-6465-6829

Branch The Netherlands

Eindhoven, The Netherlands
Tel: 040-244 58 45
Fax: 040-244 45 80

Branch Sweden

Taeby, Sweden
Tel: 08-63 80 820
Fax: 08-63 80 388

United Kingdom Branch

Milton Keynes, UK
Tel: 01908-691-133
Fax: 01908-670-290

Revision History

Date	Revision	Chapter	Description
28-01-2009	V1.00	---	First release
17-04-2009	V2.00	Chap 1, 2	Description of external LED board corrected
11-05-2009	V3.00	Chap 7	Updated to Applilet EZ for HCD V3.50

Table of Contents

1. Introduction	11
1.1 Package contents	11
1.2 Features	11
1.3 System requirements	12
1.4 Trademarks	12
2. Hardware	13
2.1 Power Supply	13
2.2 LED Drivers	13
2.3 On-board LUXEON Rebel LEDs	14
2.4 External LED Board	16
2.5 LED Light Engine Connector	16
2.6 RS-485/DMX-512 Interface	17
2.7 RS-232 Interface	17
2.8 Expansion IO Connector	17
2.9 USB Programming and Debugging Interface	18
2.10 Ambient Light Sensor	18
2.11 Temperature Sensor	18
2.12 DIP Switch	18
2.13 Reset Switch	18
3. Shine It! installation and operation	19
3.1 Getting started	19
3.2 CD-ROM contents	19
3.3 Pre-programmed Demo-Application	19
4. Hardware installation	20
5. Software installation	20
5.1 Applilet EZ for HCD Controller installation	20
5.2 IAR Systems Embedded Workbench for 78K installation	21
5.3 Device file package of μ PD78F8024 for IAR Embedded Workbench installation	21
5.4 WriteEZ3 installation	21
5.5 USB Driver Installation	21
5.5.1 Installation on Windows 2000	21
5.5.2 Installation on Windows XP	25
5.6 Confirmation of USB Driver Installation	27
6. Applilet EZ for HCD Controller	29
7. Using the Applilet EZ for HCD Controller	30
7.1 Exercise 1 – Applilet EZ for HCD Controller settings	30

7.2	Exercise 2 – Fix dimmer program	32
7.3	Exercise 3 – Variable dimmer program.....	34
7.4	Exercise 4 – Analog input program.....	37
7.5	Exercise 5 – UART0 serial command program	39
8.	Flash Programmer WriteEZ3.....	45
8.1	Device Setup.....	45
8.2	Using WriteEZ3.....	46
9.	Set up a IAR C-SPY debug session.....	47
9.1	Flashing the Debug monitor	47
9.2	Changing the EXEC communication DLL.....	47
9.3	Debugging the project within the IAR Embedded Workbench	48
10.	Cables	51
10.1	USB interface cable (Mini-B type)	51
11.	Schematics	52
12.	Bill of materials	54
13.	EV-K0-HCD Board Assembly	56
14.	Board Layout.....	57

List of Figures

Figure 1: EV-K0-HCD Board (Top View).....	13
Figure 2: EV-K0-HCD Board (Bottom View)	13
Figure 3: Driving the On-board LEDs.....	15
Figure 4: Driving External LED Boards	16
Figure 5: Driving the Dialight Light Engines	16
Figure 6: <i>Shine It!</i> CDROM autorun.exe	20
Figure 7: Found New Hardware Wizard (Windows 2000).....	21
Figure 8: Search Method (Windows 2000).....	22
Figure 9: Driver File Location (Windows 2000).....	22
Figure 10: Address Specification 1 (Windows 2000)	23
Figure 11: Address Specification 2 (Windows 2000)	23
Figure 12: Address Specification 3 (Windows 2000)	24
Figure 13: Driver File Search (Windows 2000)	24
Figure 14: USB Driver Installation Completion (Windows 2000)	24
Figure 15: Found New Hardware Wizard 1 (Windows XP).....	25
Figure 16: Found New Hardware Wizard 2 (Windows XP).....	25
Figure 17: Search Location Specification 1 (Windows XP).....	26
Figure 18: Search Location Specification 2 (Windows XP).....	26
Figure 19: Windows XP Logo Testing (Windows XP).....	27
Figure 20: USB Driver Installation Completion (Windows XP).....	27
Figure 21: Windows Device Manager	28
Figure 22: Applilet EZ for HCD Controller Main Window	30
Figure 23: Applilet EZ for HCD Controller Setting	30
Figure 24: Applilet EZ for HCD Controller CPU settings	31
Figure 25: Applilet EZ for HCD UART settings	31
Figure 26: Applilet EZ for HCD Controller Compiler selection	32
Figure 27: Applilet EZ for HCD Controller Folder Settings.....	32
Figure 28: Applilet EZ for HCD Controller Dimmer Program settings (Fix).....	32
Figure 29: Applilet EZ for HCD Controller Save File as (fix.xml)	33
Figure 30: Applilet EZ for HCD Controller All Program button	33
Figure 31: Applilet EZ for HCD Controller compilation progress.....	33
Figure 32: Applilet EZ for HCD Controller Start Flash programming	34
Figure 33: Applilet EZ for HCD Controller Flash programming status	34
Figure 34: Applilet EZ for HCD Controller Save File as (variable.xml)	35
Figure 35: Applilet EZ for HCD Controller Dimmer Program selection (Variable)	35
Figure 36: Applilet EZ for HCD Dimmer Programming Window	35
Figure 37: Applilet EZ for HCD Controller Wave Editor (set)	36
Figure 38: Applilet EZ for HCD Controller Variable Dimmer Control settings (set).....	37
Figure 39: ADC potentiometer connection	38
Figure 40: Applilet EZ for HCD Controller Save File as (ADC.xml)	38
Figure 41: Applilet EZ for HCD Controller Dimmer Program settings (Analog Input)	39
Figure 42: Applilet Ez for HCD Controller Save File as (uart0.xml)	40
Figure 43: Applilet EZ for HCD Controller Dimmer Program settings (Serial Command)	40
Figure 44: Microsoft HyperTerminal Connection Description	41
Figure 45: Microsoft HyperTerminal Connect to	41
Figure 46: Microsoft HyperTerminal COM1 Properties.....	42
Figure 47: Microsoft HyperTerminal ASCII settings (1/2)	42
Figure 48: Microsoft HyperTerminal ASCII settings (2/2)	43
Figure 49: Microsoft HyperTerminal Command Window	43
Figure 50: WriteEZ3 Startup.....	45
Figure 51: WriteEZ Device Setup Dialogue	45
Figure 52: WriteEZ3 Device Menu	46
Figure 53: WriteEZ3 Open file.....	47
Figure 54: IAR Embedded Workbench Startup.....	48
Figure 55: IAR Embedded Workbench Open Workspace	49
Figure 56: IAR Embedded Workbench Debugger Options	49
Figure 57: IAR Embedded Workbench Linker Options	50
Figure 58: IAR Embedded Workbench .xcl file selection	50

Figure 59: USB interface cable (Mini-B type).....	51
Figure 60: EV-K0-HCD schematics 1 / 2.....	52
Figure 61: Ev-K0-HCD schematics 2 / 2	53
Figure 62: EV-K0-HCD Top Assembly.....	56
Figure 63: EV-K0-HCD Bottom Assembly.....	56
Figure 64: EV-K0-HCD Top Layer.....	57
Figure 65: EV-K0-HCD Layer 1	57
Figure 66: EV-K0-HCD Board Layer 2	58
Figure 67: EV-K0-HCD Bottom Layer	58

List of Tables

Table 1: LED Light Engine Connectors16
Table 2: RS-485/DMX-512 Connectors17
Table 3: RS-232 Connector.....17
Table 4: Expansion IO Connector17
Table 5: Board Configuration Options18
Table 6: *Shine It!* CD-ROM directory structure19
Table 7: WriteEZ3 action buttons46
Table 8: Bill of materials EV-K0-HCD board55

1. Introduction

The *Shine it!* evaluation kit for NEC Electronics' highly integrated, general-purpose μ PD78F8024 microcontroller (MCU) with high-current drive allows you to demonstrate the MCU's capabilities and easily develop intelligent code for emerging high-power LED lighting applications. Compact yet flexible and functionally versatile, the board can be used to drive four channels of single or multiple high-power LEDs in any of three different configurations:

- With the on-board LUXEON® Rebel™ LEDs
- Example for Use of External LED Board
- Using off-the-shelf LED lighting engines such as the Dialight linear engine

The board also can be used to control and dim individual LED channels by means of analog and digital sensor inputs, such as temperature, light and color. Various serial communication protocols are supported by this board, including I²C, SPI, RS-232, and RS-485/DMX-512. Users can program, change, and debug code easily and free of charge using the on-board USB programming and debugging interface (available June 2008).

1.1 Package contents

- EV-K0-HCD board
- 15V_{dc}/1A power supply
- USB cable
- One set of plastic stands and screws
- CD-ROM with Applilet EZ software and an evaluation copy of the IAR Embedded Workbench for 78K with 4Kbyte code size limitation

Please verify that you have received all parts listed in the package contents list attached to the *Shine it!* package. If any part is missing or seems to be damaged, please contact the dealer from whom you received your *Shine it!*.

1.2 Features

- NEC Electronics μ PD78F8024 high-current-drive (HCD)/LED MCU
- NEC Electronics μ PA2756 dual N-channel MOSFETs
- Four channels of constant high-current LED drivers
- Buck topology
- Up to 700 mA per channel
- Supply voltage from 10 to 24 V_{dc}
- On-board LUXEON Rebel LEDs (red/green/blue/white)
- Four External LED Board Connectors
- Four LED light engine connectors
- USB programming and debugging interface

- RS-232 interface
- RS-485/DMX-512 interface
- Expansion IO connector
- On-board temperature sensor
- On-board ambient light sensor
- DIP switch for board configurations
- Reset switch for uPD78F8024 device reset

1.3 System requirements

HOST PC	A PC supporting Windows 2000, Windows XP or Windows Vista is required for the IAR Systems Embedded Workbench demo-version. A Pentium processor with at least 1 GHz CPU performance, with at least 256 Mbytes of RAM, allowing you to fully utilize and take advantage of the product features. 500 Mbytes of free disk space and an additional 10 Mbytes of free disk space on the Windows system drive.
Host interface	A web browser and Adobe Acrobat Reader to be able to access all the product documentation. USB interface that enables communication based on USB (Ver1.1 or later)

Note: Updates of the IAR Embedded Workbench for 78K, documentation and/or utilities for the *Shine it!* Starter Kit, if available, may be downloaded from the NEC WEB page(s) at <http://www.eu.necel.com/SHINEIT>

1.4 Trademarks

IAR Embedded Workbench, visualSTATE, IAR MakeApp and C-SPY are registered trademarks of IAR Systems AB. Microsoft, Windows and HyperTerminal are registered trademarks of Microsoft Corporation. Adobe and Acrobat Reader are registered trademarks of Adobe Systems Incorporated.

All other product names are trademarks or registered trademarks of their respective owners.

2. Hardware

The EV-K0-HCD board measures 3.15 × 3.15 inches or 80 × 80 millimeters (mm). This small form factor is enabled by the use of components such as inductors that are small in size thanks to the μ PD78F8024 MCU's constant-current drives with high switching frequency.

The board is designed with four layers. The top layer contains most of the components, the first middle layer serves as the power plane, the second middle layer adds additional space for traces, and the bottom layer serves as the ground plane and assembly for the temperature sensor and high-power LEDs.

The heat generated by the LEDs is dissipated through the pads and vias surrounding the LEDs, and LED temperature is sensed by the temperature sensor mounted on top of the dissipation pad.

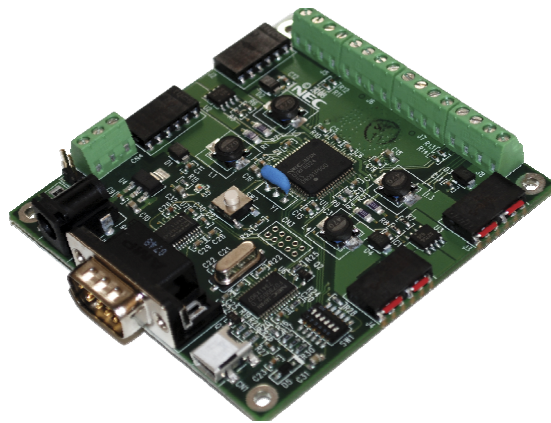

Figure 1: EV-K0-HCD Board (Top View)

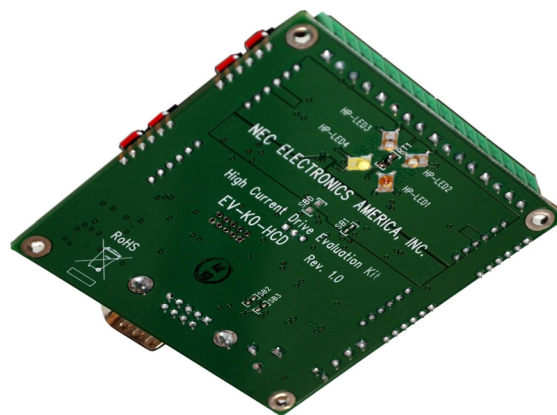

Figure 2: EV-K0-HCD Board (Bottom View)

2.1 Power Supply

The EV-K0-HCD board requires a 10 to 24 V_{DC} power supply with output wattage of at least 5 watts (W) to light the high-power LEDs. The barrel-type power jack mounted on the board accepts a 2.1 mm center pole connector (center positive).

2.2 LED Drivers

The board's four-channel LED drivers are set in buck topology for 350 milliamps (mA) of constant output current. However, you can increase output current up to 700 mA by changing the current sensor's

resistor values using the following formula (refer to R1, R2, R3 and R4 in the schematics). Please note that you

need to change the inductors (refer to L1, L2, L3 and L4 in the schematics) current rating accordingly if you wish to drive at more than 350mA.

$$R_S = 0.115 / I_{LED}$$

Fomula 1

Where R_S = current sensor's resistor value and I_{LED} = LED current. When driving the LEDs at 350 mA, the current sensor's resistor value should be set to 0.33 ohm (Ω).

The number of LEDs that can be used in series per channel is determined by the supply voltage and the LED forward voltage using this formula:

$$N_{MAX} \leq V_{IN} / V_F$$

Fomula 2

Where V_{IN} = supply voltage, V_F = LED forward voltage current, and N_{MAX} = maximum number of LEDs in series per channel.

Generally, the sum of LED forward voltages must be less than the supply voltage for buck mode operation. For a 24V power supply, for example, a maximum of six LEDs with 3.5V forward voltage may be used in series per channel.

LED driver outputs can be connected in one of three configurations:

- To the on-board LUXEON Rebel high-power LEDs
- To LED boards with LUXEON K2 high-power LEDs
- To LED light engines

2.3 On-board LUXEON Rebel LEDs

There are four LUXEON Rebel high-power LEDs mounted on the back of the EV-K0-HCD board, one red (R), one green (G), one blue (B) and one white (W). By default, the board is set to drive the LEDs with jumper wires inserted into the four Tyco six-position receptacle connectors (refer to J1, J2, J3 and J4 in the schematics).

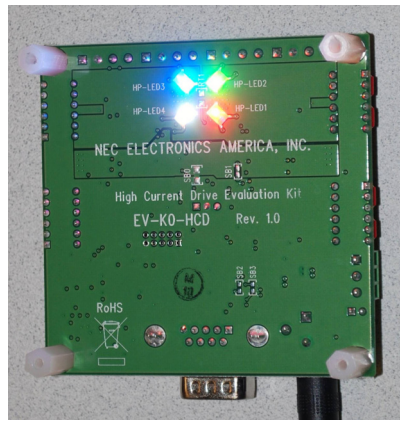

Figure 3: Driving the On-board LEDs

2.4 External LED Board

The EV-K0-HCD board can connect and drive commercially available external LED boards. To do so, you must first remove the jumper wires inserted into the four Tyco receptacle connectors (J1, J2, J3 and J4) before installing the LED boards. You can then cascade multiple LED boards in one channel as long as the number of LEDs meets the requirement specified by Formula 2.

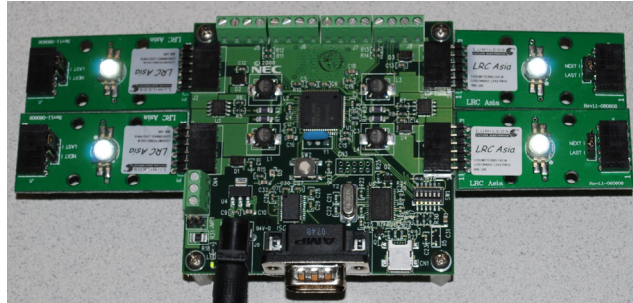

Figure 4: Driving External LED Boards

2.5 LED Light Engine Connector

The EV-K0-HCD board has four LED light engine connectors (refer to J5, J6, J7 and J8 in the schematics) to the 4-pin terminal block. The following table describes the function of each pin.

Pin Number	Function
1	Analog input
2	Ground
3	LED anode
4	LED cathode

Table 1: LED Light Engine Connectors

They can be used to drive up to four off-the-shelf LED light engines, for example, the POWERWHITE™ linear light engine modules from Dialight. Before installing the modules, you must first remove the jumper wires inserted at the four Tyco receptacle connectors (J1, J2, J3 and J4).

The analog inputs (pin 1 & 2) on the connectors are mainly for connecting to off-board thermister on the light engine module but can be used for any analog inputs, such as potentiometer, light sensors, etc. Please not that each analog input is biased with a 10kohm resistor (refer to R11, R12, R13 and R14).

Note: There are six LUXEON Rebel high-power LEDs in series in one POWERWHITE light engine module. Therefore the power supply must be a 24V_{DC}/1.5A with a 2.1mm center pole (center positive) Jack connector to meet the requirement specified by Formula 2.



Figure 5: Driving the Dialight Light Engines

2.6 RS-485/DMX-512 Interface

The EV-K0-HCD board supports DMX-512 protocol over RS-485 using the MCU's UART0 port. The RS-485/DMX-512 connector is a 3-pin terminal block connector that accepts up to 24 American Wire Gauge (AWG) wires.

Pin Number	Function
1	Ground
2	D-
3	D+

Table 2: RS-485/DMX-512 Connectors

The μ PD78F8024 MCU's UART0 port is shared between the RS-485 and RS-232 connectors through a Maxim level shifter (refer to U7 in the schematics). By default, the RS-485 connector is enabled and the RS-232 one is disabled.

If required, an on-board 110 Ω resistor can be inserted between D+ and D- of the RS-485/DMX-512 port as a terminating resistor. By default, the resistor is disconnected. To connect it, insert a jumper into the JMP1 header (refer to JMP1 in the schematics).

2.7 RS-232 Interface

A DB9 male connector is used for the RS-232 interface. By default, RS-232 function is disabled. To enable it, place DIP switch (refer to SW1 in the schematics) position 4 in the "ON" position.

Pin Number	Function
2	TX
3	RX
5	Ground
1,4,6,7,8,9	Not connected

Table 3: RS-232 Connector

2.8 Expansion IO Connector

A dual-row 10-pin header footprint in 2mm-pitch is available on the EV-K0-HCD board (refer to CN3 in the schematics), the μ PD78F8024 device's UART0/CSI and I2C signals are pulled out on this connector. The following table shows the pin out connections.

Pin Number	Pin Name	Description
1	GND	Ground
2	VDD	Logic power supply
3	RX/SI	UART0 RX signal / CSI data input signal
4	TX/SCK	UART0 TX signal / CSI clock signal
5	SO	CSI data output signal
6	IO	P0.0 / Timer TM00 capture input
7	SCL	I ² C clock signal
8	SDA	I ² C data signal
9	GND	Ground
10	VDD	Analog voltage reference

Table 4: Expansion IO Connector

The expansion IO connector pin outs are compatible with the NEC Electronics ZigBee sticks interface; users can add ZigBee / 802.15.4 wireless capability to LED lighting applications.

2.9 USB Programming and Debugging Interface

The EV-K0-HCD evaluation board implements an on-board USB programming and debugging interface using the NEC Electronics μ PD78F0730 USB MCU. You can download code to the μ PD78F8024 HCD/LED MCU from a host computer via a mini-USB cable, and then proceed to debug that code (for information about debugging refer to the regarding chapter).

2.10 Ambient Light Sensor

The EV-K0-HCD board populates a miniature surface-mount light sensor, part number APDS-9005 from Avago Technologies, to sense the intensity of ambient light. By default, this sensor is disconnected from the μ PD78F8024 MCU's A/D converter input. To connect to it, place DIP switch (SW1) position 5 in the "ON" position.

2.11 Temperature Sensor

The EV-K0-HCD board populates a negative temperature coefficient (NTC) 10 k Ω thermistor to sense the temperature of the on-board LEDs. By default, the thermistor is disconnected from the μ PD78F8024 MCU's A/D converter input. To connect to it, place DIP switch position 6 in the "ON" position.

2.12 DIP Switch

The EV-K0-HCD board uses a 6-position DIP switch (SW1) for configuration purposes. The following table shows the various configuration options.

Switch No.	Setting	
	OFF	ON
SW1-1	USB programming mode	Normal operation
SW1-2	Don't Care	Self-flash programming mode
SW1-3	User-defined	User-defined
SW1-4	RS-485 enabled / RS-232 disabled	RS-232 enabled / RS-485 disabled
SW1-5	Ambient light sensor disabled	Ambient light sensor enabled
SW1-6	Temperature sensor disabled	Temperature sensor enabled

Table 5: Board Configuration Options

2.13 Reset Switch

The on-board reset switch (refer to SW2 in the schematics) can be used to reset the μ PD78F8024 MCU.

3. *Shine it!* installation and operation

3.1 Getting started

The Applilet EZ for HCD Controller allows a GUI based program building and downloading application programs to the EV-K0-HCD board. Therefore it is necessary to have a valid IAR Embedded Workbench for 78K installation on the PC host system. As communication interface between the PC host system and the EV-K0-HCD board a standard USB interface line is needed. Before you can download and run a program, software and hardware have to be installed properly.

3.2 CD-ROM contents

The CD-ROM shows following directory structure:









NEC Shine It!	CD-ROM ROOT
 Acrobat	- Acrobat Reader for 32Bit Windows OS
 Applilet	- Applilet EZ for HCD controller
 Device file package	- μ PD78F8024 Device file package
 Doc	- Documentation
 dotnet	- Microsoft dotnet package
 Driver	- EV-K0-HCD driver files
 IAR Embedded Workbench	- IAR Embedded Workbench for 78K
 samplehex	- Example program for the <i>Shine it!</i> Starter Kit
 WriteEZ3	- Flash Programmer WriteEZ3 incl. PRM file for μ PD78F8024

Table 6: *Shine it!* CD-ROM directory structure

3.3 Pre-programmed Demo-Application

The EV-K0-HCD board is pre-programmed with a demonstration code that cyclically dims the four on-board high-power LEDs. To run the demo application, make sure that the DIP switch SW1-1 is set to **ON** when connecting the power supply or the USB cable to the EV-K0-HCD board.

4. Hardware installation

After unpacking the 78K0 *Shine it!* Starter kit, connect the board via connector CN1 to your host computer using the provided USB interface cable. When EV-K0-HCD board is connected, the USB driver needs to be installed on the host machine. Please refer to the following **CHAPTER 5 SOFTWARE INSTALLATION**.

5. Software installation

The *Shine it!* package comes with the following software packages:

- Applilet EZ for HCD Controller
- IAR Systems Embedded Workbench for 78K 4Kbyte code size limited, including C compiler, assembler, linker, librarian and IAR C-SPY debugger / simulator
- Device file package of μ PD78F8024 for IAR Embedded Workbench for 78K
- WriteEZ3 flash programmer including the PRM file for μ PD78F8024

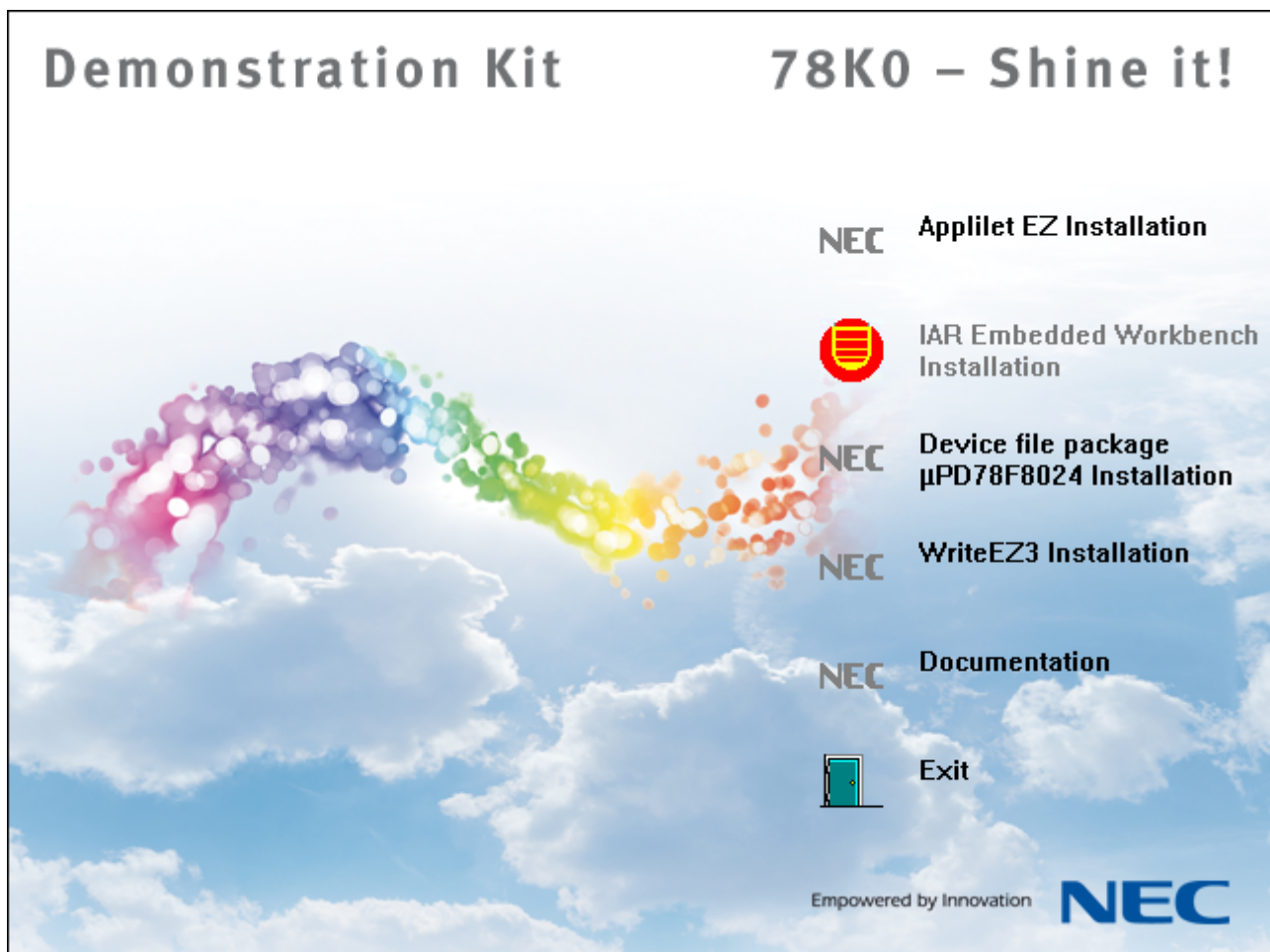

Figure 6: *Shine it!* CDROM autorun.exe

5.1 Applilet EZ for HCD Controller installation

To install the Applilet EZ for HCD Controller just press the regarding button from the Autorun of the CD-ROM provided within the *Shine it!* package. The setup dialogues will guide you through the installation process. The installation can also be started by executing the `AppEZHCD.msi` in the directory “\Applilet” of the CDROM.

5.2 IAR Systems Embedded Workbench for 78K installation

To install the IAR Systems Embedded Workbench for 78K including C-SPY debugger / simulator press the regarding button from the Autorun of the CDROM provided within the *Shine it!* package. The setup dialogues will guide you through the installation process. The installation can also be started by executing the `Autorun.exe` program in the directory "`\IAR Embedded Workbench\`" of the CDROM. For further information about the IAR Embedded Workbench installation refer to the `InstallationGuide.ENU.pdf` in the directory of the CDROM.

Note: Please make sure to install the device file package of the μ PD78F8024 for the IAR Embedded Workbench, as explained below, before using the Applet EZ for code generation and download to the target device.

5.3 Device file package of μ PD78F8024 for IAR Embedded Workbench installation

To install the device file package of the μ PD78F8024 for the IAR Embedded Workbench just press the regarding button from the Autorun of the CD-ROM provided within the *Shine it!* package. The setup dialogues will guide you through the installation process. The installation can also be started by executing the `dev_install.exe` in the directory "`\Device file package`" of the CDROM.

5.4 WriteEZ3 installation

To install WriteEZ3 for the IAR Embedded Workbench just press the regarding button from the Autorun of the CD-ROM provided within the *Shine it!* package. The setup dialogues will guide you through the installation process. The installation can also be started by executing the `setup.exe` in the directory "`\WRITEEZ3`" of the CDROM.

5.5 USB Driver Installation

In order to use the EV-K0-HCD board the USB driver needs to be installed on the host machine. Install the driver according to the following procedure:

Installation on Windows 2000	Page 21
Installation on Windows XP	Page 25

5.5.1 Installation on Windows 2000

1. When the EV-K0-HCD board is connected with the host machine, the board is recognized by <Plug and Play>, and the wizard for finding new hardware is started. Click **Next>**.

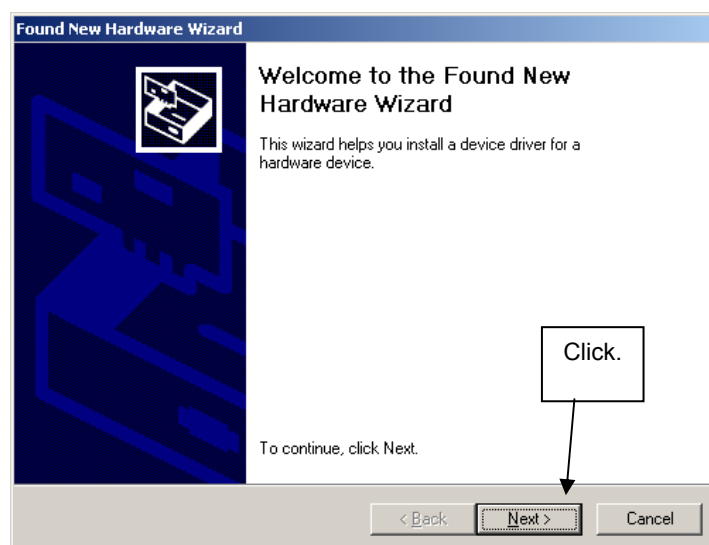

Figure 7: Found New Hardware Wizard (Windows 2000)

2. Following the window below is displayed. So, check that "Search for a suitable driver ..." is selected, then click **Next>**.

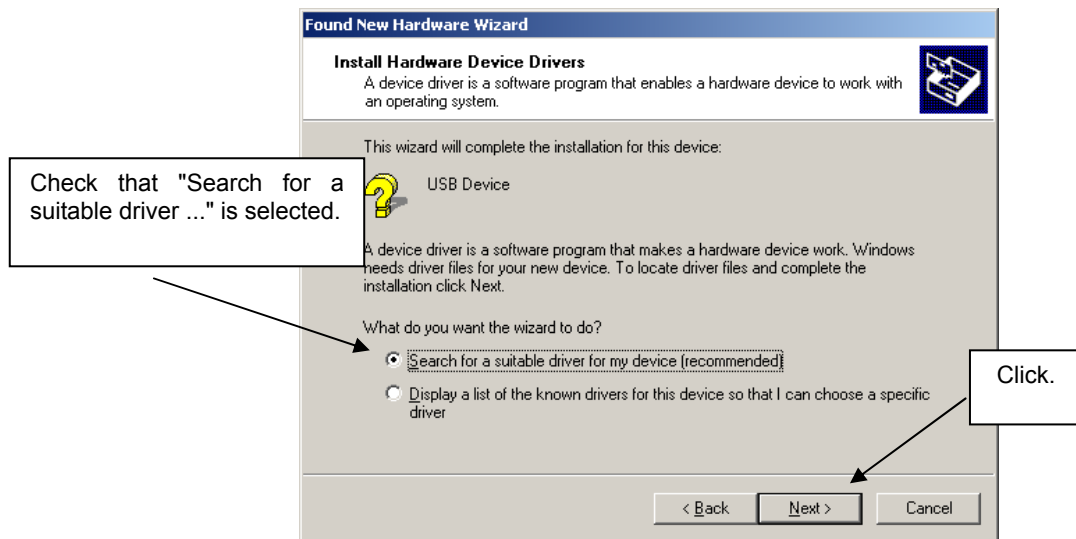

Figure 8: Search Method (Windows 2000)

3. Check the "Specify a location" check box only, then click **Next>**.

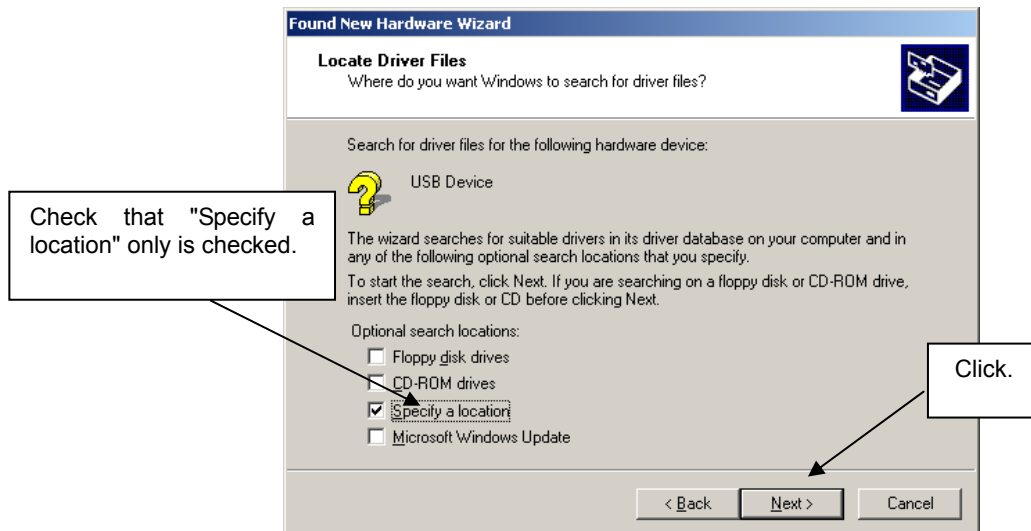

Figure 9: Driver File Location (Windows 2000)

4. Locate to the folder "CDROM:\Driver\EV-K0-HCD".

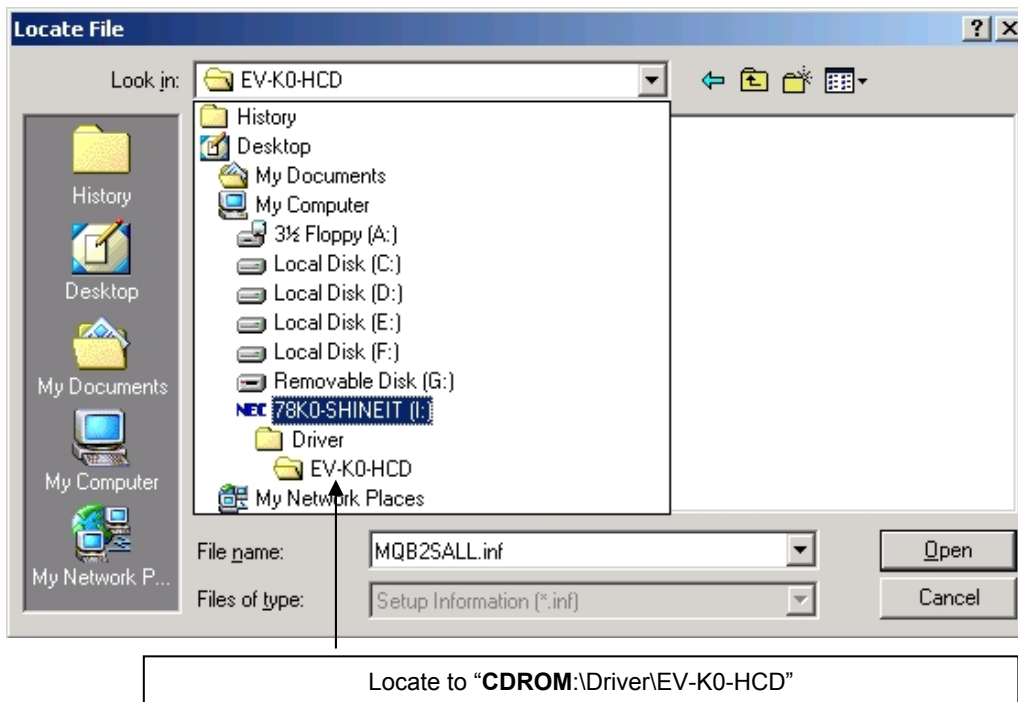

Figure 10: Address Specification 1 (Windows 2000)

- 5. The setup information file “MQB2ALL.inf” is automatic selected, then click **Open** to proceed within driver installation.

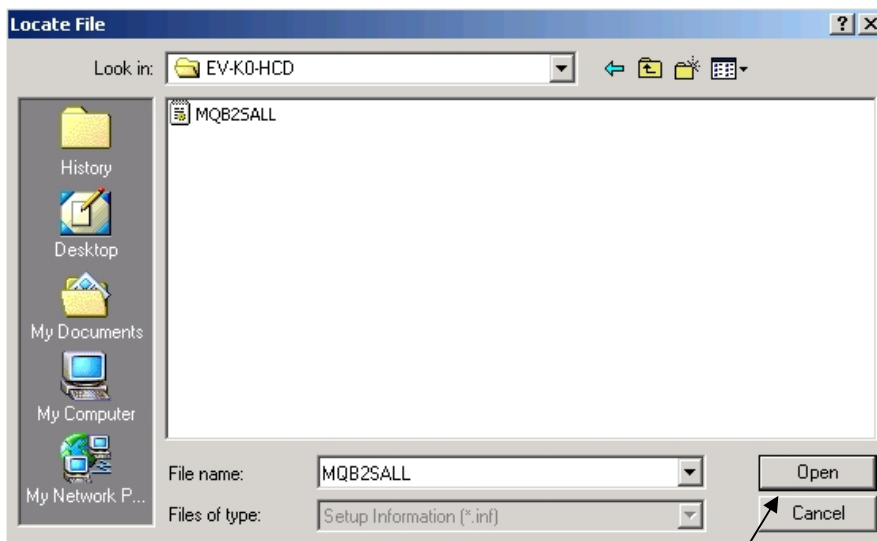

Figure 11: Address Specification 2 (Windows 2000)

- 6. After the location of the USB driver has been specified click **OK** to proceed.

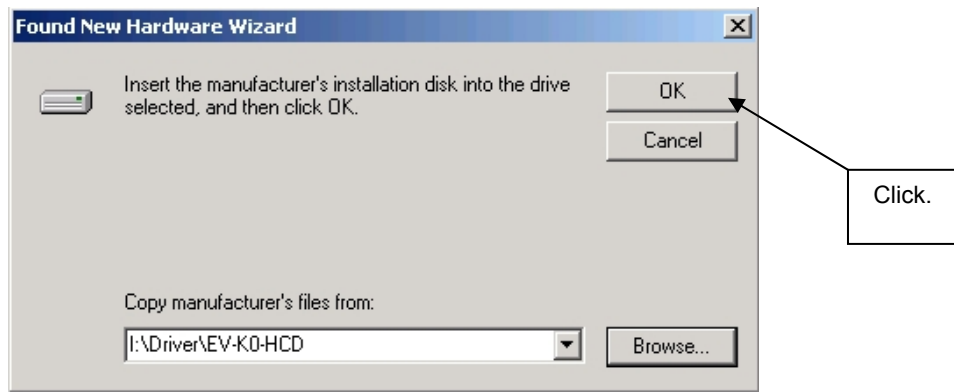

Figure 12: Address Specification 3 (Windows 2000)

- 7. Click **Next>**.

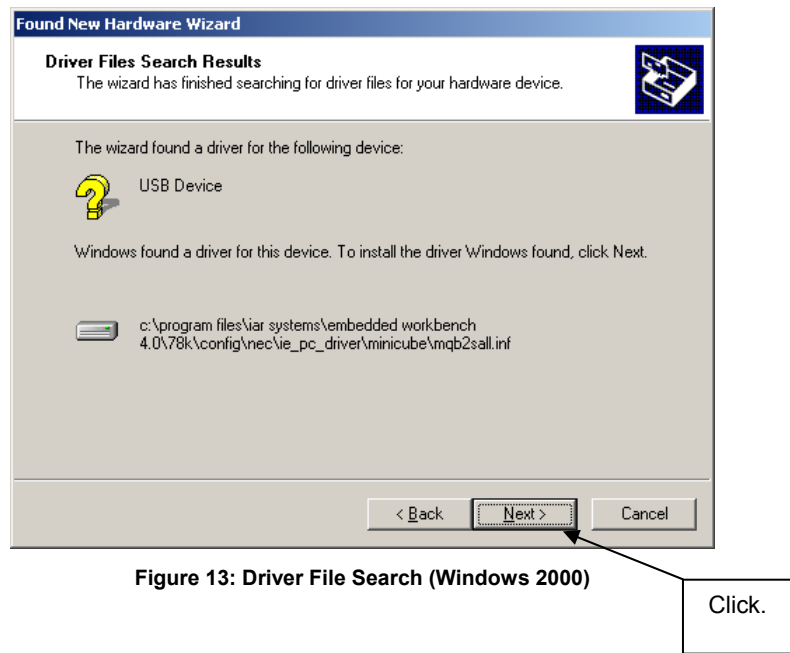

Figure 13: Driver File Search (Windows 2000)

- 8. Click **Finish** to complete the installation of the USB driver.

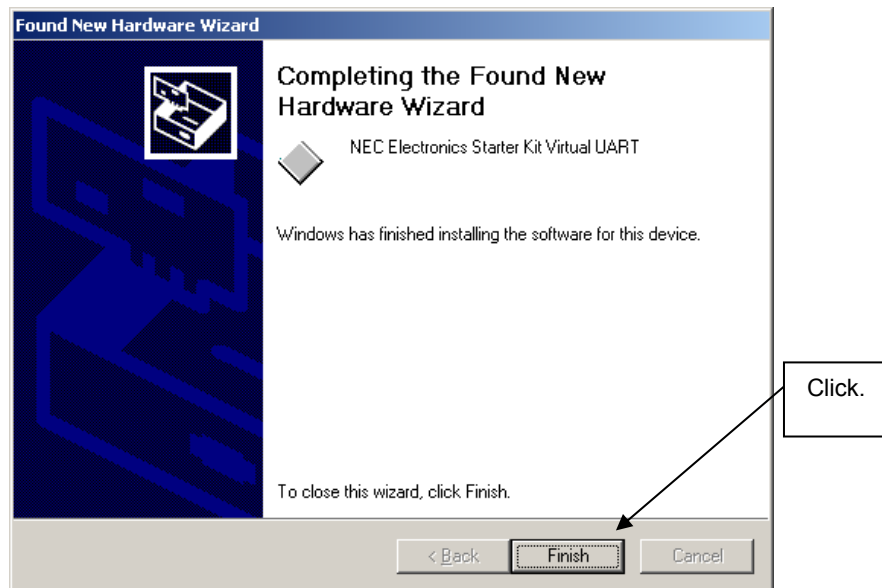

Figure 14: USB Driver Installation Completion (Windows 2000)

5.5.2 Installation on Windows XP

1. When the EV-K0HCD board is connected with the host machine, the board is recognized by Plug and Play, and the wizard for finding new hardware is started. At first the hardware wizard will ask if windows should search on the windows update web, check "No, not this time" and then click **Next>**.



Figure 15: Found New Hardware Wizard 1 (Windows XP)

2. Check that "Install from a list or specific location (Advanced)" is selected, then click **Next>**.

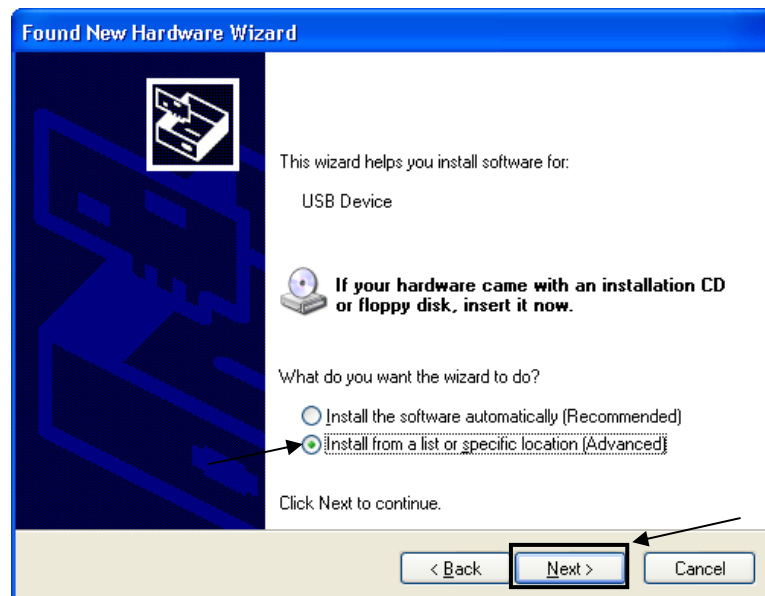

Figure 16: Found New Hardware Wizard 2 (Windows XP)

3. Check that "Search for the best driver in these locations." is selected. Select the "Include this location in the search:" check box and then click **Browse**.

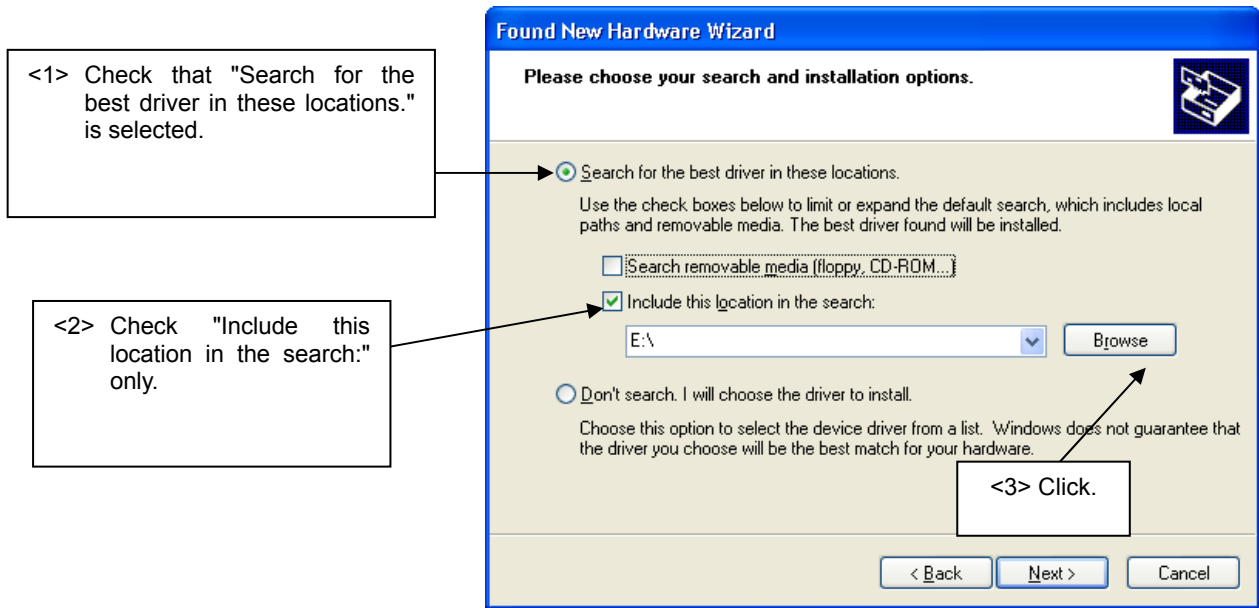

Figure 17: Search Location Specification 1 (Windows XP)

4. Locate the folder "C **CDROM**:\Driver\EV-K0-HCD" and click **OK**.



Figure 18: Search Location Specification 2 (Windows XP)

5. As shown below, "NEC Electronics Starter Kit Virtual UART has not passed Windows Logo testing to verify its compatibility with Windows XP." is displayed. Click **Continue Anyway**.



Figure 19: Windows XP Logo Testing (Windows XP)

6. After the installation of the USB driver is completed the window below is displayed. Click **Finish** to close the hardware wizard.

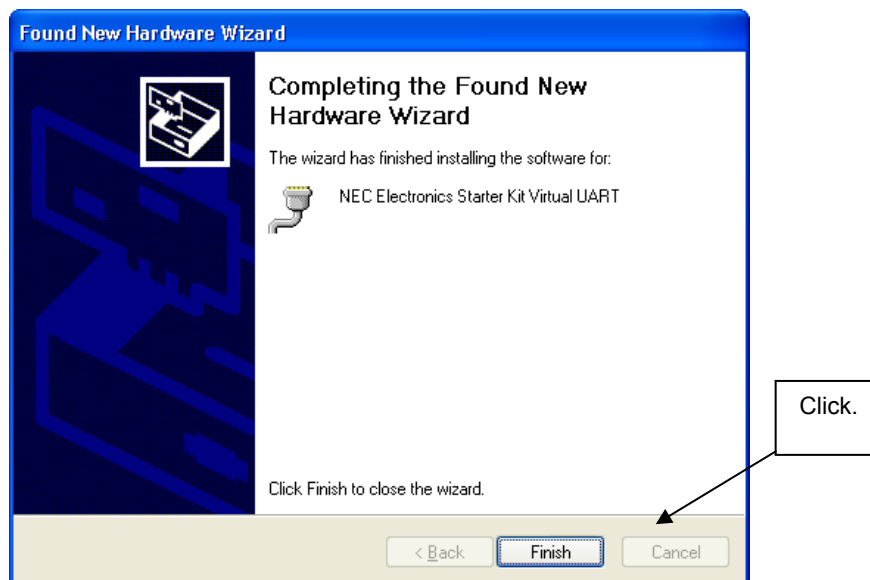

Figure 20: USB Driver Installation Completion (Windows XP)

5.6 Confirmation of USB Driver Installation

After installing the USB driver, check that the driver has been installed normally, according to the procedure below. When using the EV-K0-HCD board the "NEC Electronics Starter Kit Virtual UART" should be present like in the figure below.

Please check in the Windows "Device Manager" within the Windows Properties ("Hardware" tab), that the driver is installed normally.

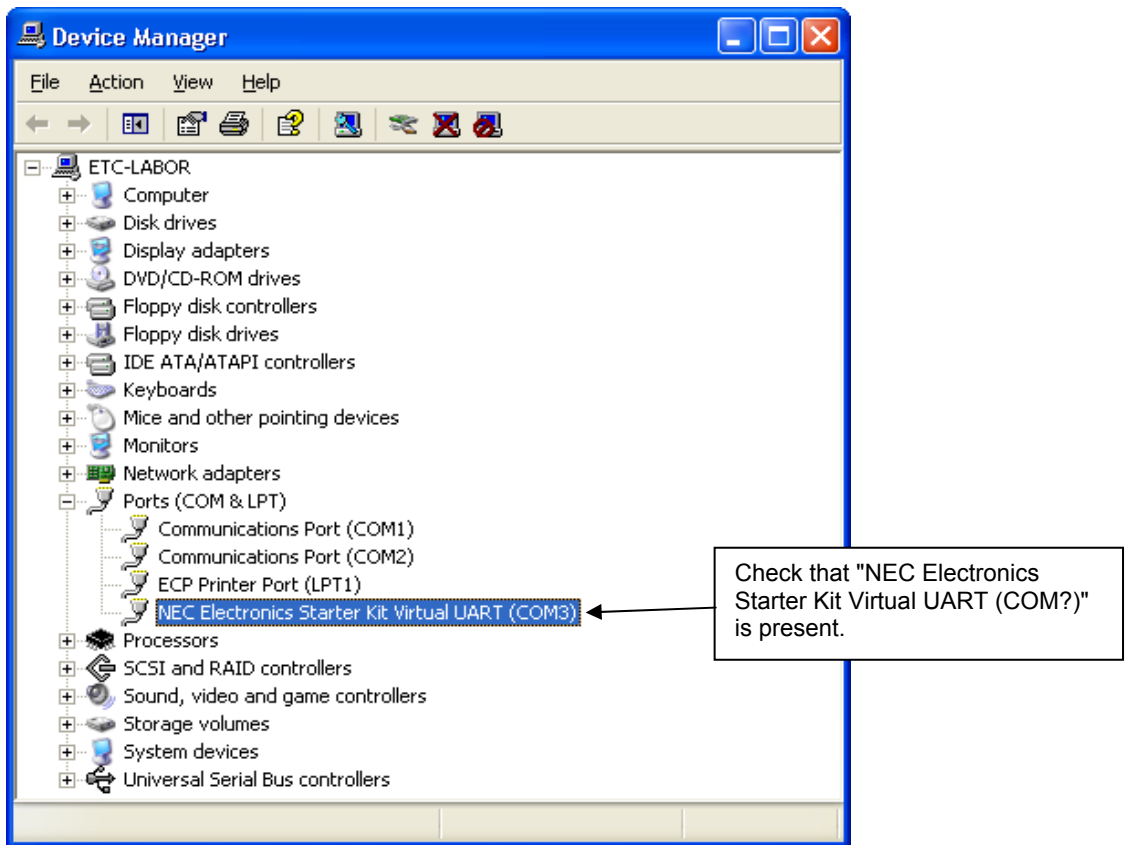

Figure 21: Windows Device Manager

6. Applilet EZ for HCD Controller

Applilet EZ for HCD Controller is a tool used to automatically generate software for microcontroller μ PD78F8024, which is used to control the high current driver, and write programs.

Software can be easily generated by specifying the setting and operation of the μ PD78F8024 on the GUI. The generated software can be directly written to the flash memory of the μ PD78F8024 via a USB cable and an operation check can be performed by using the EV-K0-HCD evaluation board.

By using Applilet EZ for HCD Controller, an application system that uses the μ PD78F8024 can be introduced without requiring a detailed knowledge of complex programming languages. Furthermore, labor for software development for microcontrollers, which used to take a long time, and operation checking can be significantly reduced.

For a further information please refer to the Applilet EZ for HCD Controller User's Manual (U19178EJ4V0UM00.pdf) which can be found in the "**CDROM:\Doc\Applilet EZ**" folder.

7. Using the Applilet EZ for HCD Controller

In the following chapter the different functionalities will be explained in short exercises. Exercise 1 and 2 can be used as short quick start example to light up the LEDs mounted to the EV-K0-HCD board. The exercise 3 to 5 will give a further description of the possibilities in usage of the Applilet EZ for HCD Controller.

7.1 Exercise 1 – Applilet EZ for HCD Controller settings

This exercise will go through the Applilet EZ for HCD controller's general settings.

1. Open the Applilet EZ for HCD. Click **Start** → **All Programs** → **Applilet EZ for HCD** → **AppEzHCD**.

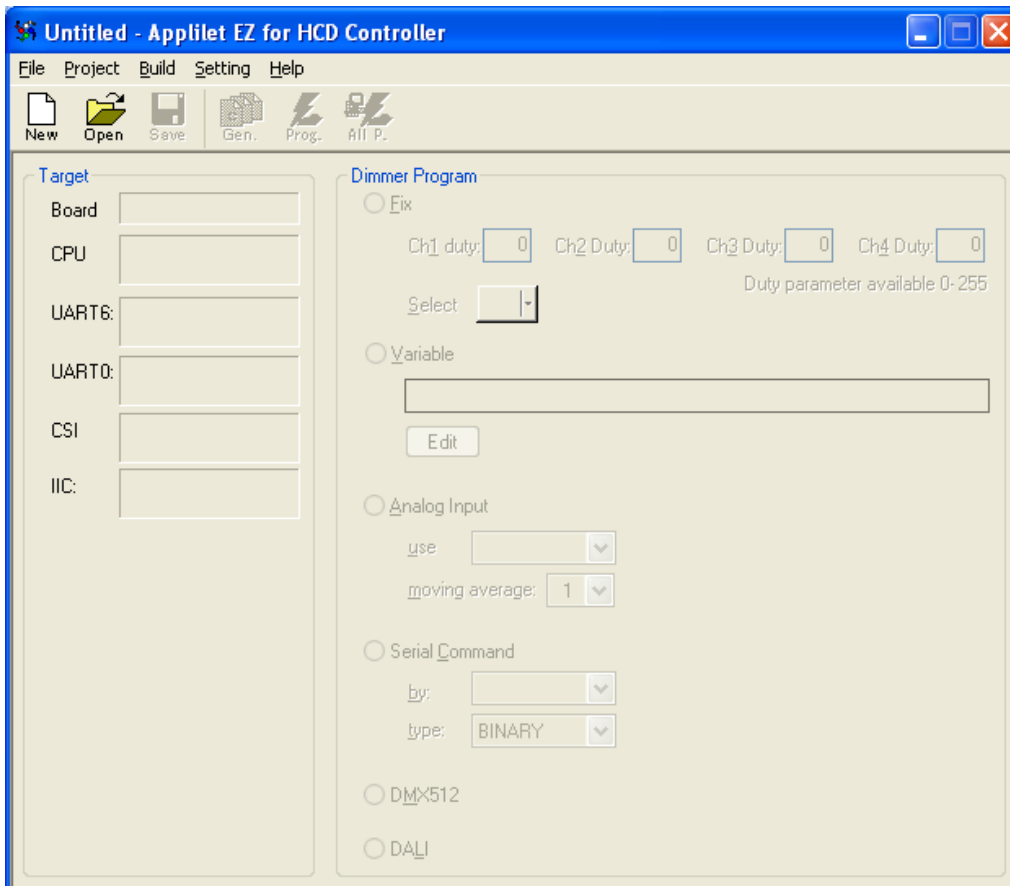

Figure 22: Applilet EZ for HCD Controller Main Window

2. Under the Project menu all of the MCU settings will be listed for configuration. Select **CPU**.

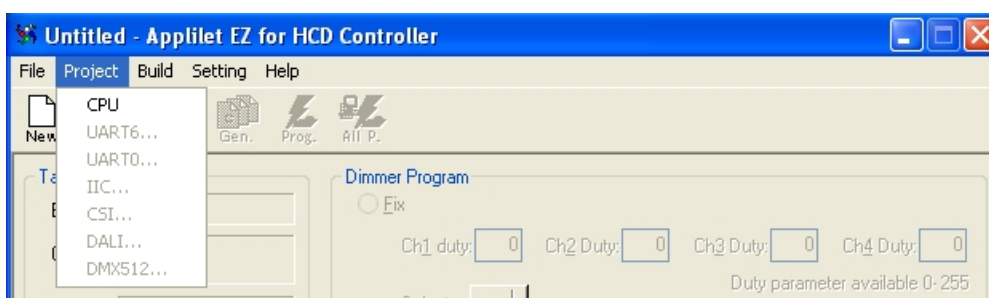

Figure 23: Applilet EZ for HCD Controller Setting

- In the CPU settings you have to select the Target EV-K0-HCD. Under the clock setting you can choose between the internal 8 MHz and external clock/oscillator setting. **Make sure the clock is on External 8 MHz and then click OK.** Furthermore you can select the active LED channels.

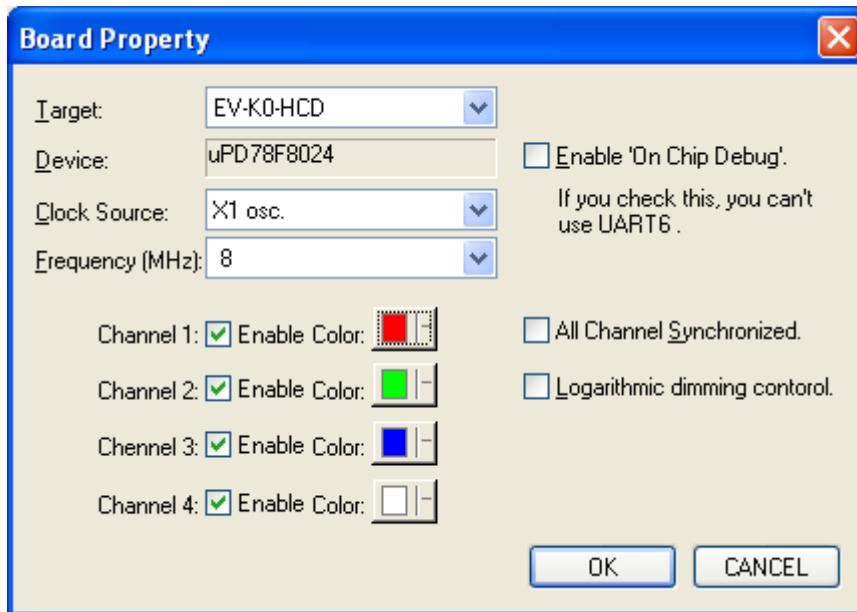

Figure 24: Applilet EZ for HCD Controller CPU settings

- The uPD78F8024 device contains two UART peripherals. Applilet EZ allows configuration these peripherals for the simple control programs. We will take a look at UART0. **Select Project → UART0.**



Figure 25: Applilet EZ for HCD UART settings

- In the UART0 setting you can configure the baud rate or “Speed” and the “Parity” type. **Click OK** to leave the setting at 9600bps and odd parity.
- The Applilet EZ is able to use the NEC Compiler for 78K0 as well as the IAR Embedded Workbench for 78K. To select click **Setting → Compiler** and choose the IAR compiler when using the Applilet EZ for HCD Controller with the *Shine It!* starter kit.



Figure 26: Applilet EZ for HCD Controller Compiler selection

Note: Make sure that you have installed the selected compiler correctly to your PC host system before building the project.

- Now let's take a look at the output folder option, select **Setting** → **Folders...** These locations will specify the output paths of the generated files. Enter in your desire destination but keep in mind that Applilet EZ will create subdirectories under this folder for each Applilet EZ project. **Click OK.**

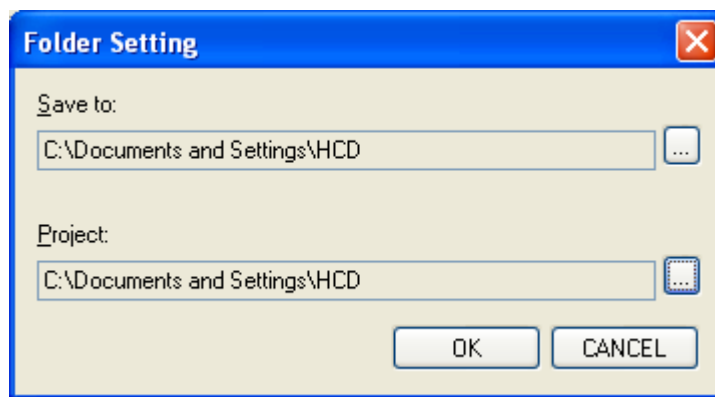

Figure 27: Applilet EZ for HCD Controller Folder Settings

7.2 Exercise 2 – Fix dimmer program

This program set a fixed duty value for each channel of the 4 LED channels. Make sure that all settings like explained in [Exercise 1](#) are still correctly set for this exercise.

- Make sure “Fix” is still selected as the dimmer program and input “10” to all the channels so they are not too bright.

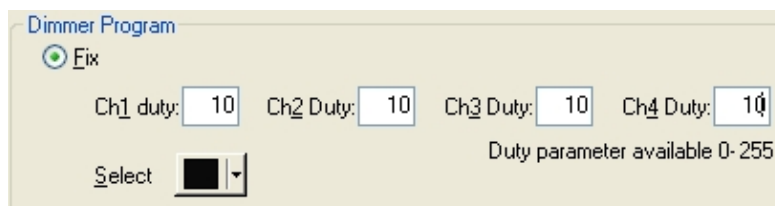

Figure 28: Applilet EZ for HCD Controller Dimmer Program settings (Fix)

- Now let's save the Applilet EZ project (.xml). We will resave the new Applilet EZ project name to fix.xml. **Select File** → **Save as..** and input “fix.xml” and then click **Save.**

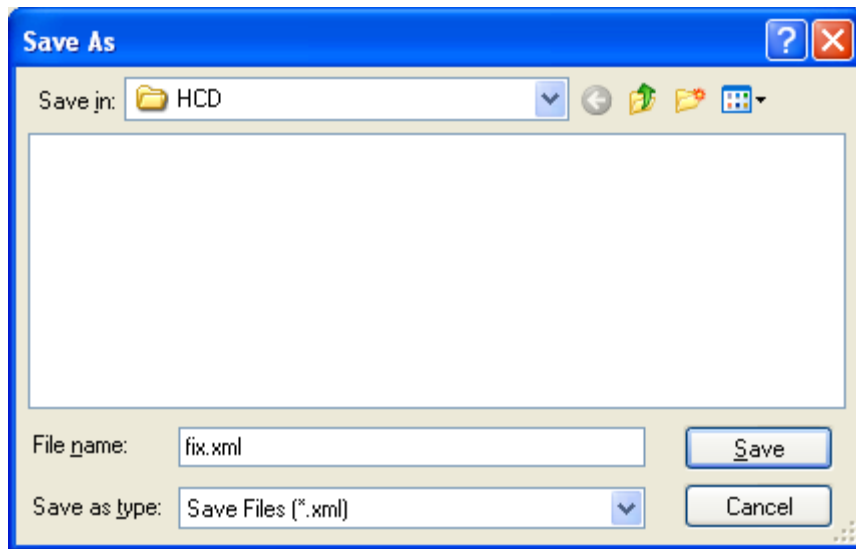

Figure 29: Appilet EZ for HCD Controller Save File as (fix.xml)

3. Make sure to remove the power cable. Click the **All P.** Button. Make sure that **SW1.1** of the Switch Dip is in the **OFF** position which is the programming mode and then **insert the USB connector**.



Figure 30: Appilet EZ for HCD Controller All Program button

4. You will be informed about the progress of the compilation.

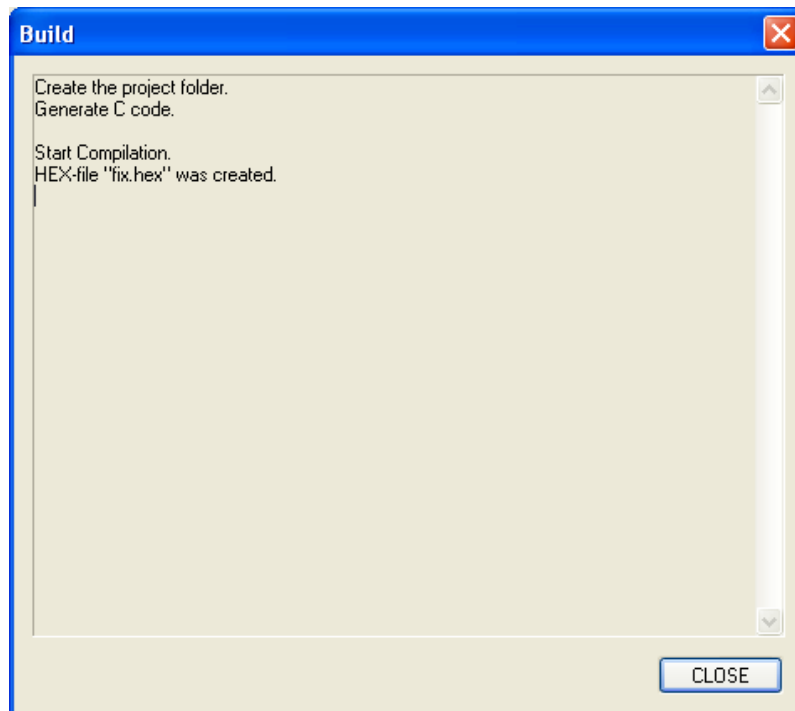

Figure 31: Appilet EZ for HCD Controller compilation progress

5. Next click OK when prompt to start flash programming.

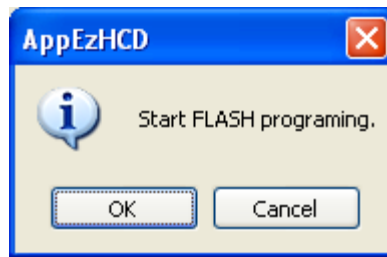

Figure 32: Applilet EZ for HCD Controller Start Flash programming

6. During the flash procedure you will be informed about the actual status of the download

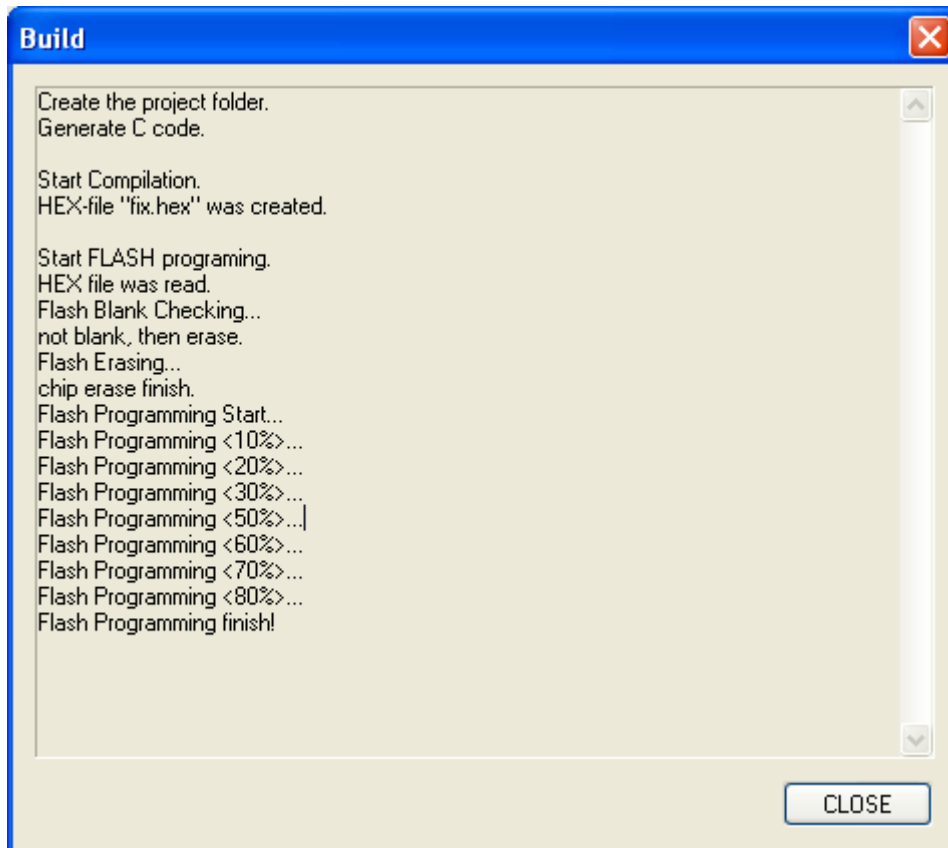

Figure 33: Applilet EZ for HCD Controller Flash programming status

7. **Click CLOSE** to exit the “Build” window. Remove the USB and change SW1.1 to the on position for run mode. Insert the power connector or the USB cable to the board and you should see the LEDs light up to finish this exercise.

- I. HP-LED1(channel 1) = Red
- II. HP-LED2(channel 2) = Green
- III. HP-LED3(channel 3) = Blue
- IV. HP-LED4(channel 4) = White

7.3 Exercise 3 – Variable dimmer program

This program sets the duty value for each channel given by drawing pattern data.

1. Make sure that you have set all the settings as explained in [Exercise 1](#).
2. Save the new Applilet EZ project name to variable.xml. **Select File → Save as.. and input “variable.xml” and then click Save.**

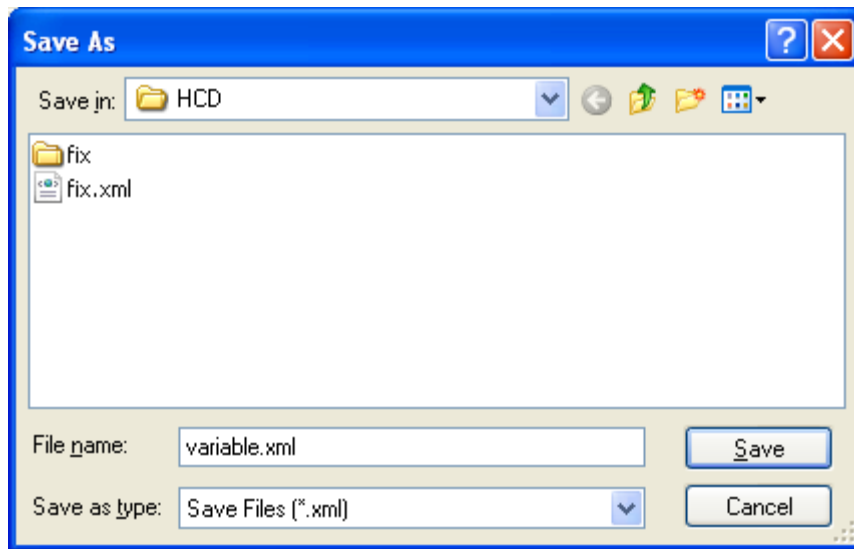

Figure 34: Applilet EZ for HCD Controller Save File as (variable.xml)

- Now we have a new Applilet EZ project file and we will change the dimmer program to “Variable”.



Figure 35: Applilet EZ for HCD Controller Dimmer Program selection (Variable)

- Click on the “Edit” button under “Variable” and the “Variable Dimmer Control” window will open. Enter “600” for the data points and enable the “Cyclic” check box. Select Ch.1 for the RED LED channel and activate the Graph Button.

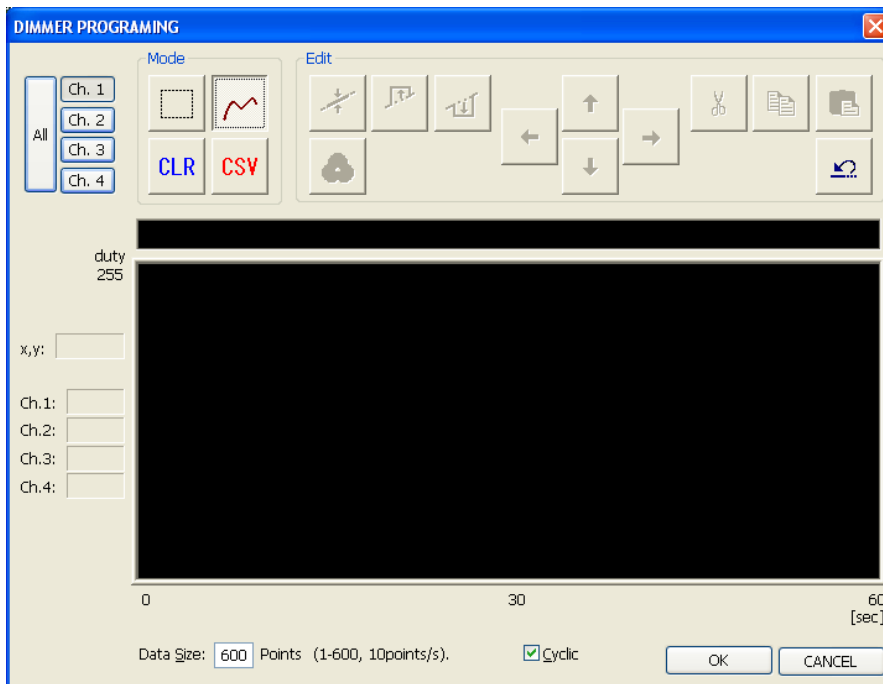

Figure 36: Applilet EZ for HCD Dimmer Programming Window

5. Using your mouse pointer you can draw the PWM duty cycle versus time in the Black window.
6. Draw something close to the sinusoidal wave below.

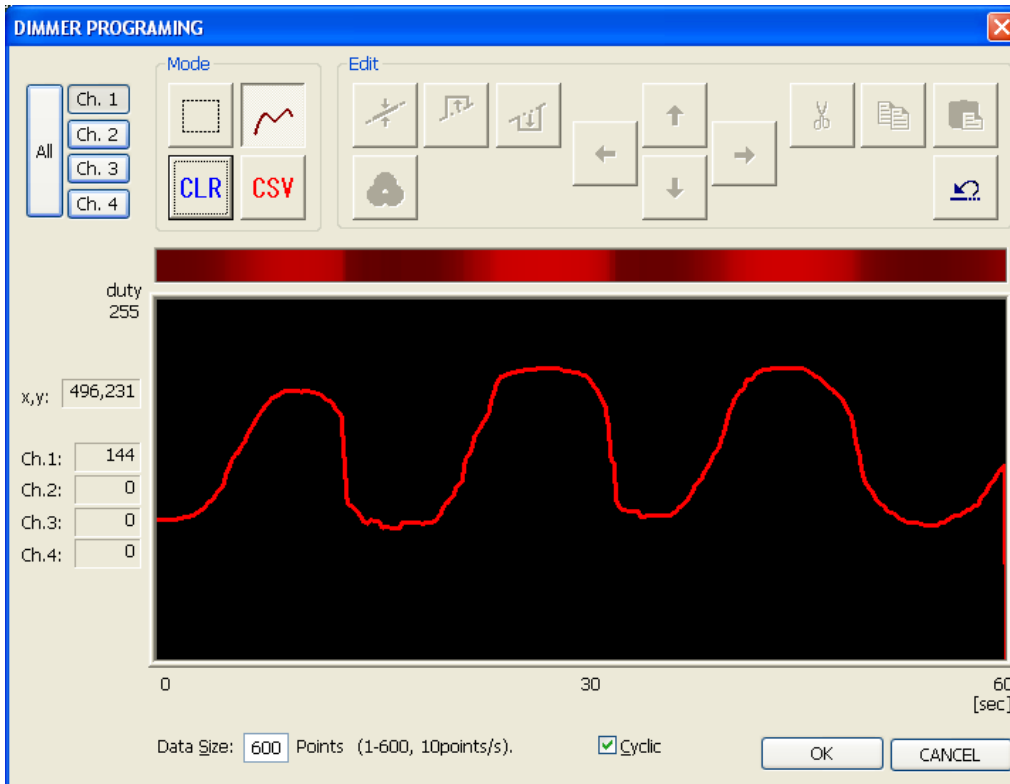

Figure 37: Appilet EZ for HCD Controller Wave Editor (set)

8. Repeat the same process for the red channel to the rest of the 3 channels. When done, **click on the close button** to exit the variable dimmer control window.

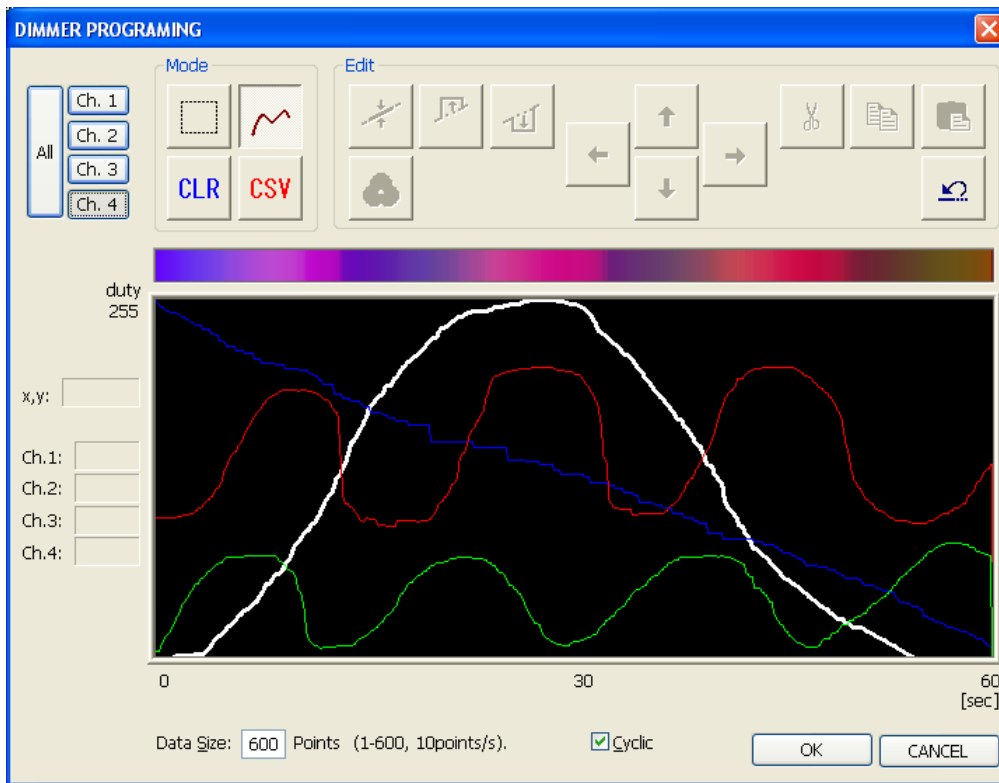

Figure 38: Applet EZ for HCD Controller Variable Dimmer Control settings (set)

9. Make sure that the EV-K0-HCD board is in programming mode (**SW1.1** set to **OFF**) and the USB cable is connected correctly. **Click the save button and afterwards the All P. button.** After downloading the application disconnect the USB and set the EV-K0-HCD board in the run mode as described in [Exercise 2](#) point 7. You should now see the LEDs on the board running the variable dimming application based on the wave table drawn.

7.4 Exercise 4 – Analog input program

This program controls the duty value for each channel by looking at the A/D conversion result. In order to perform this exercise you will need to have a 2-pole 100KΩ potentiometer attached the J5 connector which is the ADC channel 0 of the MCU.

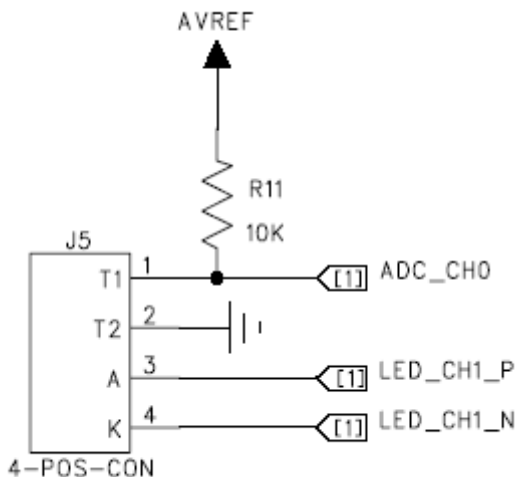

Figure 39: ADC potentiometer connection

1. Make sure that you have set all the settings as explained in [Exercise 1](#).
2. We will resave the new Applilet EZ project name to adc.xml. **Select File → Save as.. and input “ADC.xml” and then click Save.**

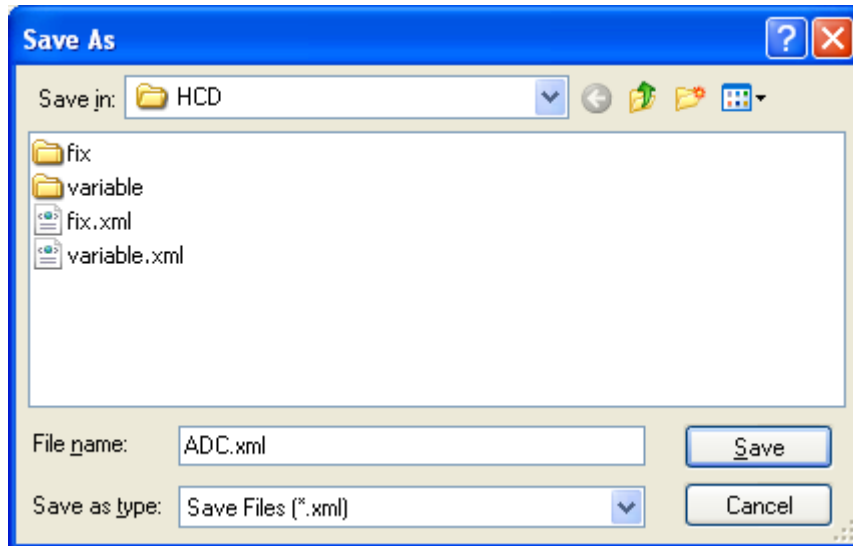

Figure 40: Applilet EZ for HCD Controller Save File as (ADC.xml)

3. Change the Dimmer Program to “Analog Input”

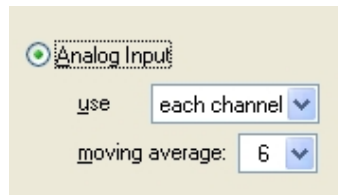

Figure 41: Applilet EZ for HCD Controller Dimmer Program settings (Analog Input)

4. Use the “each channel” selection and choose a moving average of 6.
5. Make sure that the EV-K0-HCD board is in programming mode (**SW1.1** set to **OFF**) and the USB cable is connected correctly. **Click the save button and afterwards the All P. button.** After downloading the application disconnect the USB and set the EV-K0-HCD board in the run mode as described in [Exercise 2](#) point 7. Turning the potentiometer clockwise will dim the LEDs and counter-clockwise will increase the brightness the LEDs.

7.5 Exercise 5 – UART0 serial command program

This program controls the duty value for each channel based on the given serial communication command. The serial command programs support either binary or ASCII communication format. For this exercise we will use UART0 with the ASCII command set. A straight DB9 female to female cable is required for this exercise.

Host (PC) → target (EV-K0-HCD)

ch	Comma(0x2C)	cmd	Comma(0x2C)	data	LineFeed(0x0D)	CarriageReturn(0x0A)
ch	Comma(0x2C)	cmd	Comma(0x2C)	data	LineFeed(0x0D)	CarriageReturn(0x0A)
1 byte	1 byte	2 bytes	1 byte	3 bytes	1 byte	1 byte

1. Make sure that you have set all the settings as explained in [Exercise 1](#).
2. We will resave the new Applilet EZ project name to uart0.xml. **Select File → Save as.. and input “uart0.xml” and then click Save.**

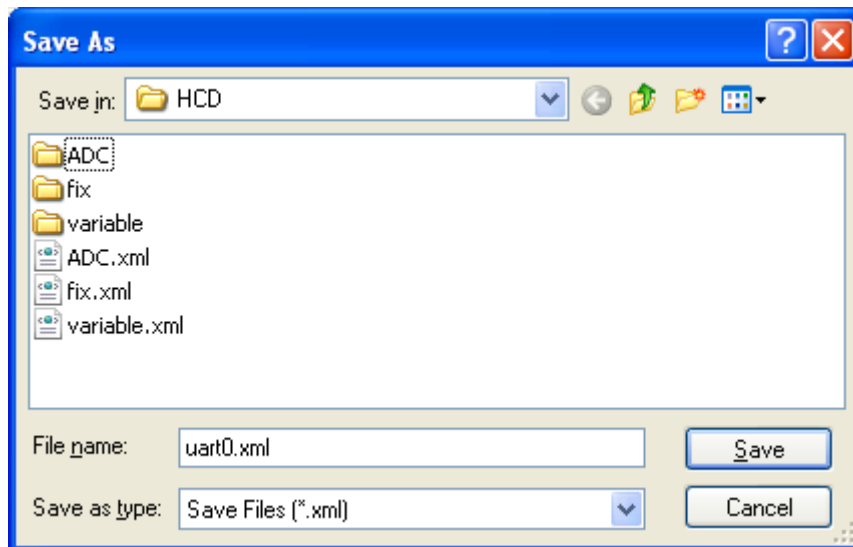

Figure 42: Applilet Ez for HCD Controller Save File as (uart0.xml)

2. Change the dimmer program to **“Serial Command”**. Select UART0 as the interface and ASCII type.



Figure 43: Applilet EZ for HCD Controller Dimmer Program settings (Serial Command)

3. Make sure to deselect the “All Channel Synchronize” check box. Configure the board into programming mode (**SW1.1** set to **OFF**) and attached the USB cable. **Click the save button and then click the All P. button.**
4. Remove the USB cable and **now change the SW1.4 to ON** in order to change the Maxim RS232/485 device to be in RS232 mode.
5. Attached the DB9 cable to the board and then apply power to the board.
6. Open a text terminal application. We will use Windows HyperTerminal as an example. **Click Start → Programs → Accessories → Communications → HyperTerminal.**
7. Enter the connection name **“EV-K0-HCD”** and click **OK**.

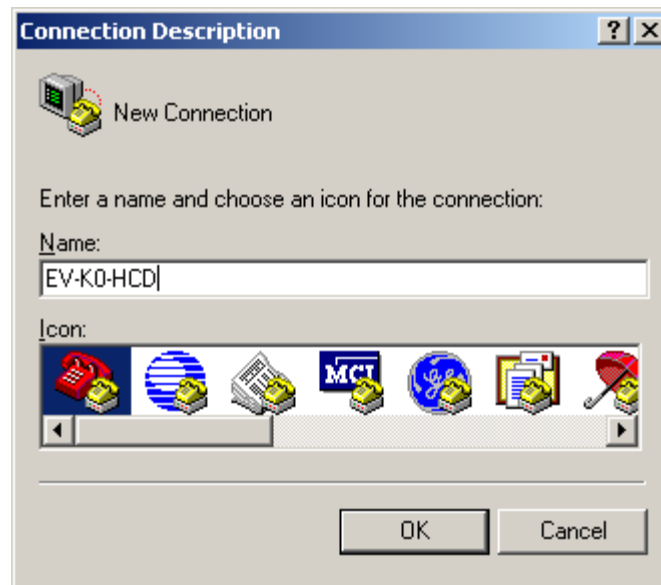

Figure 44: Microsoft HyperTerminal Connection Description

8. Specify the appropriate COM port for your connection and **click OK**.



Figure 45: Microsoft HyperTerminal Connect to

9. Input 9600 for baud rate, 8 bit, odd parity, and no flow control. **Click OK**.

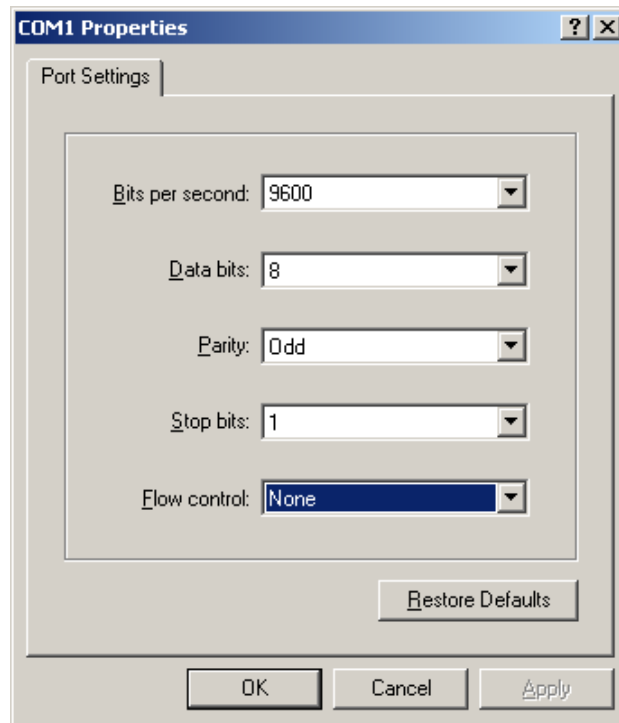

Figure 46: Microsoft HyperTerminal COM1 Properties

10. Click **File** → **Properties** → **Settings** tab. Click on the **ASCII Setup** button.

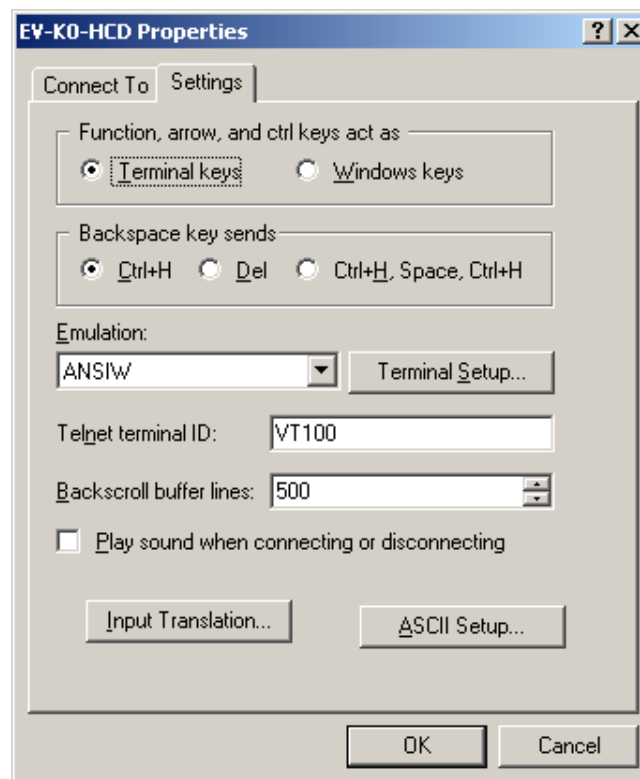

Figure 47: Microsoft HyperTerminal ASCII settings (1/2)

11. Enable the check box for “Send line ends with line feeds” and “Echo typed characters locally”. Next click OK to close the ASCII Setup window.

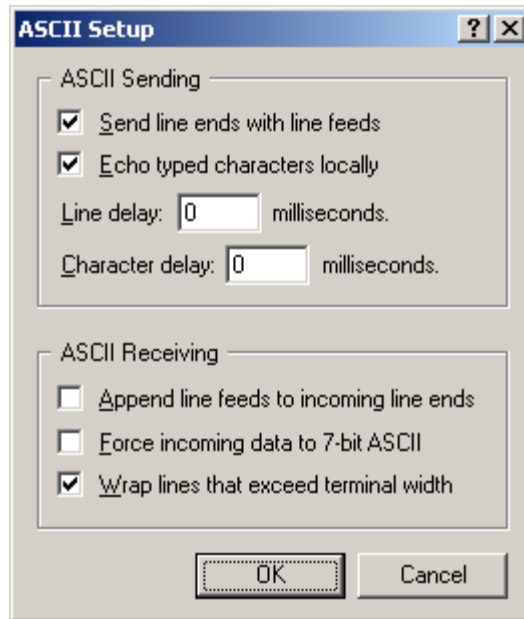

Figure 48: Microsoft HyperTerminal ASCII settings (2/2)

12. Click OK to exit the communication port properties.
13. Type “1,wd,100” and hit the Enter key in HyperTerminal. Make sure to type it correctly and that you don’t use the backspace key if you mistyped. If you mistyped hit the enter key to re-enter the command.

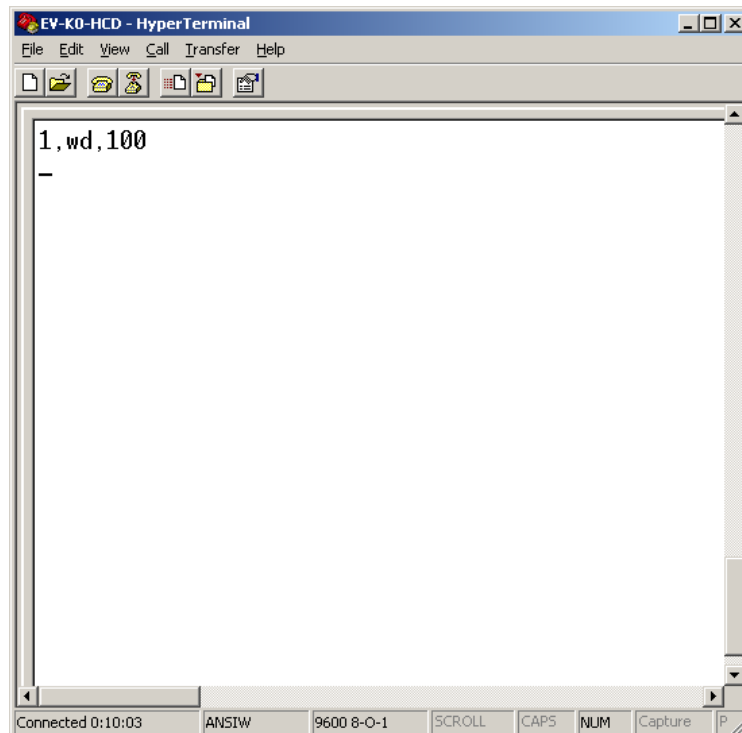
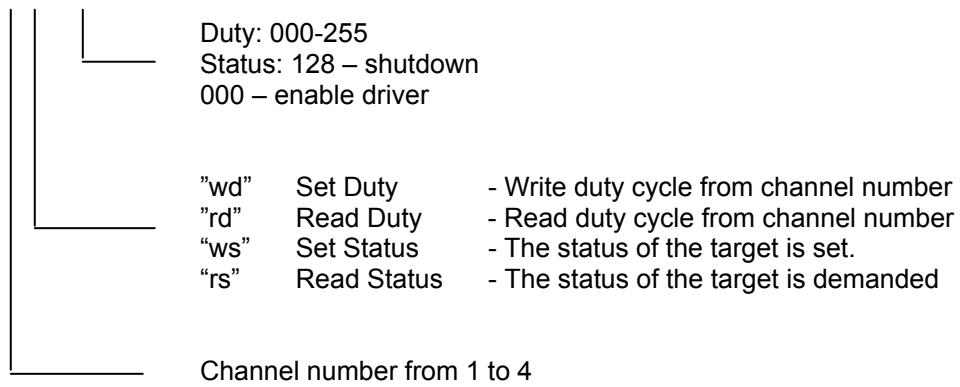

Figure 49: Microsoft HyperTerminal Command Window

14. The red LED should light up with this command.

15. Here's the command list for the ASCII input.

"1,wd,000"



16. Try to set the other channels using the ASCII command set.

8. Flash Programmer WriteEZ3

The WriteEZ3 is flash programming software to flash hex files to the related device. For installation information refer to the chapter [WriteEZ3 installation](#).

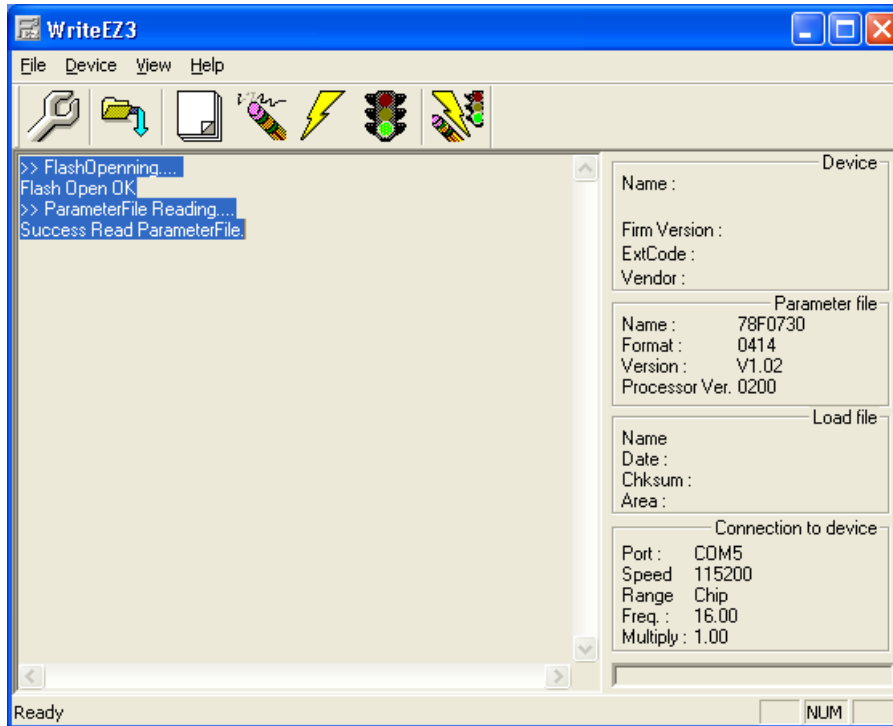

Figure 50: WriteEZ3 Startup

8.1 Device Setup

To provide all necessary information about the device to be programmed, only the corresponding flash parameter file must be loaded. The parameter file (*.prm) for the μ PD78F8024 is located on the CDROM, in the same folder as the WriteEZ3 setup file. Please use the menu "**Device -> Setup...**" to open the following dialogue and the button "**PRM File Read**" to select the parameter file.

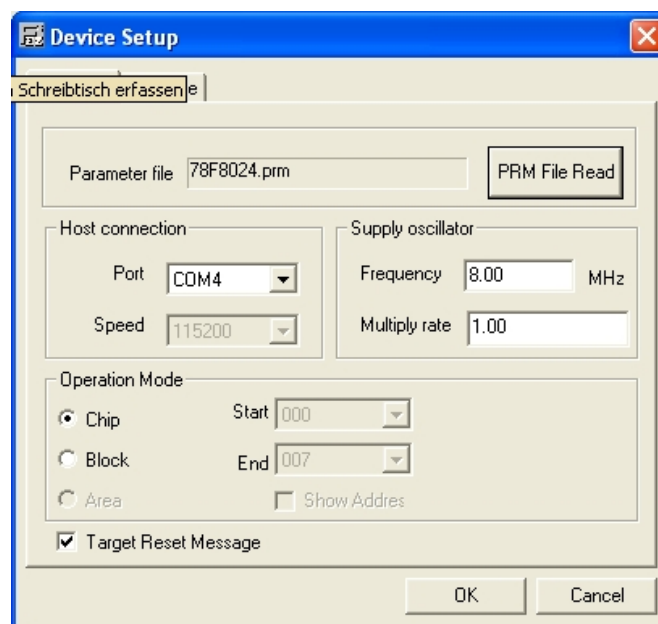

Figure 51: WriteEZ Device Setup Dialogue

Please check that the correct host communication port is selected. The used communication port can be seen in the [Windows Device Manager](#).

8.2 Using WriteEZ3

After a successful device selection the internal flash memory can be blank-checked, erased, programmed or verified. WriteEZ3 can be controlled either by menu or by buttons

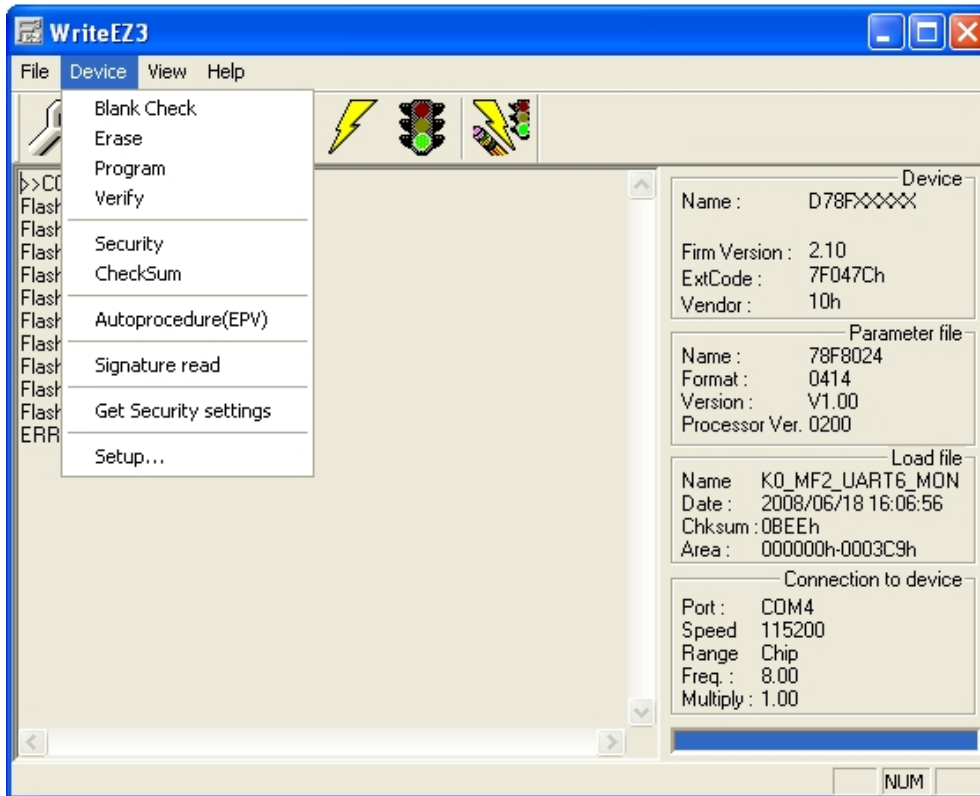

Figure 52: WriteEZ3 Device Menu







	device setup button
	load file button
	blank check button
	erase button
	program button
	verity button
	erase / program / verify button

Table 7: WriteEZ3 action buttons

WriteEZ3 supports Intel-Hex and Motorola S-record file formats as input file.

9. Set up a IAR C-SPY debug session

The following chapter describes the necessary steps to set up an IAR C-SPY debug session using the EV-K0-HCD board.

9.1 Flashing the Debug monitor

Unlike to other 78K OCD-Debug-Interfaces the debug monitor program is not automatically downloaded by the C-SPY Driver to the target device. To be able to start a debug session this debug monitor has to be downloaded by an additional tool, WriteEZ3.

Please use following configuration to make sure that the flash programming of the debug monitor works as expected.

1. Select the right .prm file as explained in chapter [8.1 Device Setup](#). The regarding 78F8024.prm file can be found on the CDROM in the folder “**CDROM\WRITEEZ3\PRM files\78K0**”
2. Set the Supply Oscillator frequency to **8MHz**
3. The next step is to load the debug monitor .hex file. **File** → **Load...** and select the “**K0_MF2_UART6_MON.hex**” from the CDROM folder “**CDROM\WRITEEZ3**”

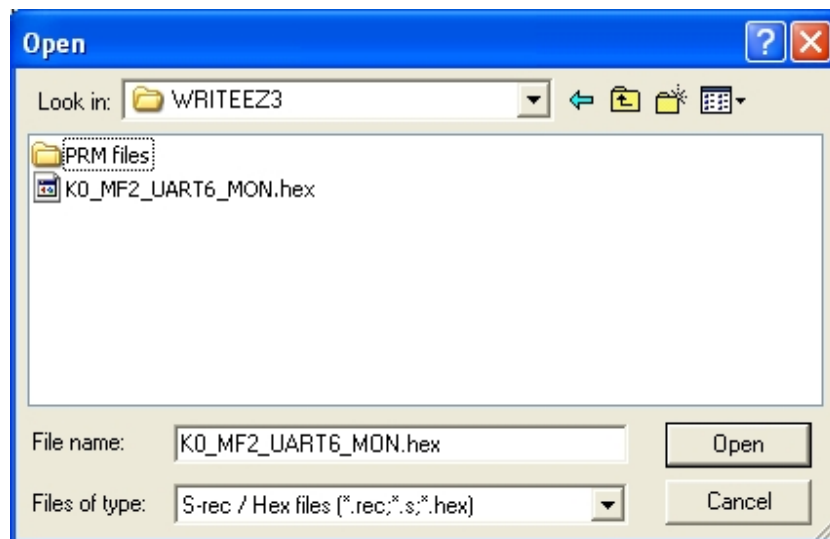

Figure 53: WriteEZ3 Open file

4. Click the **erase / program / verify** button.
5. If the procedure was successful the debug monitor is now correctly flashed to the device.

9.2 Changing the EXEC communication DLL

The next step to establish a debug session is to change the regarding debug communication DLL of the IAR Embedded Workbench.

Note: Please make sure that the IAR Embedded Workbench for 78K is closed during this procedure.

1. Locate the “**exk032o.dll**” in the **C:\Program Files\IAR Systems\Embedded Workbench Kickstart 5.0\78k\config\nec**

2. Create a backup of this file, for example “**exk032o_backup.dll**”
3. Copy the new EXEC communication DLL “**exk032ou.dll**” from the CDROM folder “**CDROM\IAR Embedded Workbench**” to the folder **C:\Program Files\IAR Systems\Embedded Workbench Kickstart 5.0\78k\config\ nec**.
4. Rename the “**exk032ou.dll**” into “**exk032o.dll**”

9.3 Debugging the project within the IAR Embedded Workbench

1. Start the IAR Embedded Workbench for 78K. **Start** → **All Programs** → **IAR Systems** → **IAR Embedded Workbench Kickstart for NEC 78K**
2. Click the “**Open existing workspace**” button

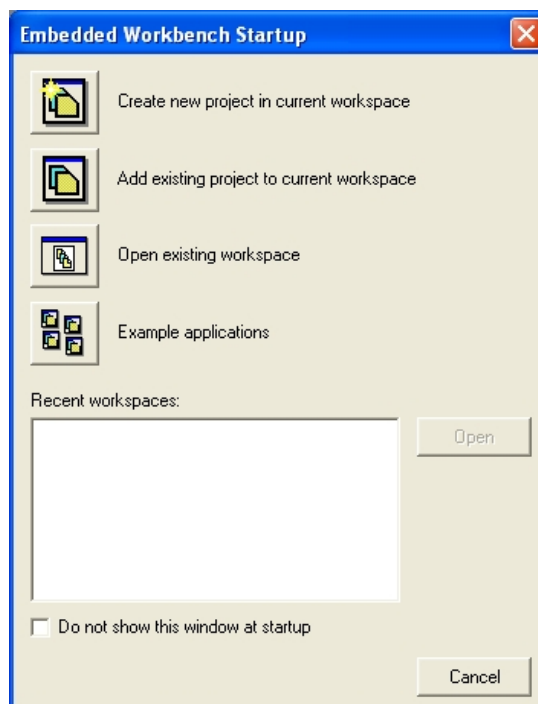

Figure 54: IAR Embedded Workbench Startup

3. Open your with Applilet EZ for HCD Controller created IAR workspace file .eww.

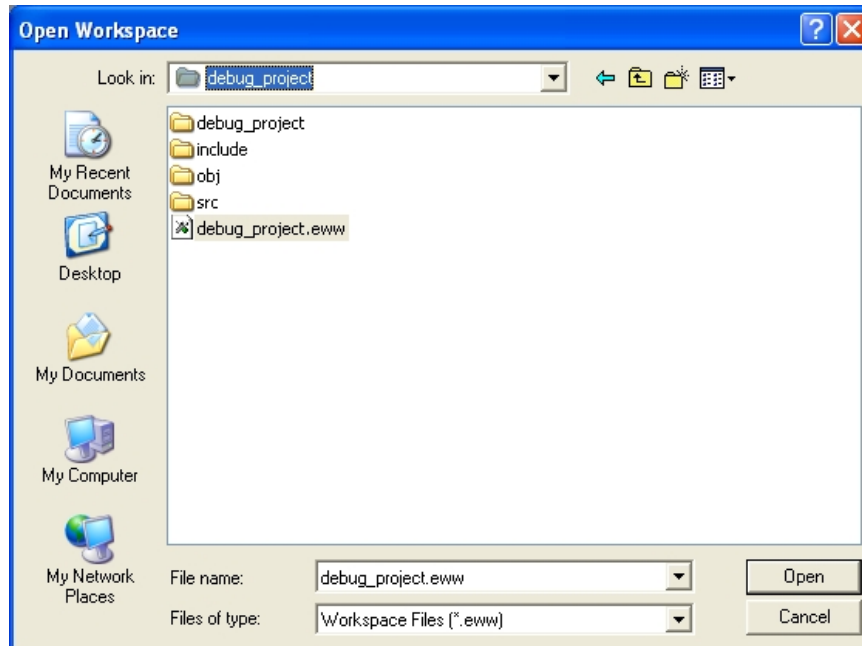

Figure 55: IAR Embedded Workbench Open Workspace

4. Select the MINICUBE as debugger driver. **Project** → **Options** → **Debugger** → **Driver**

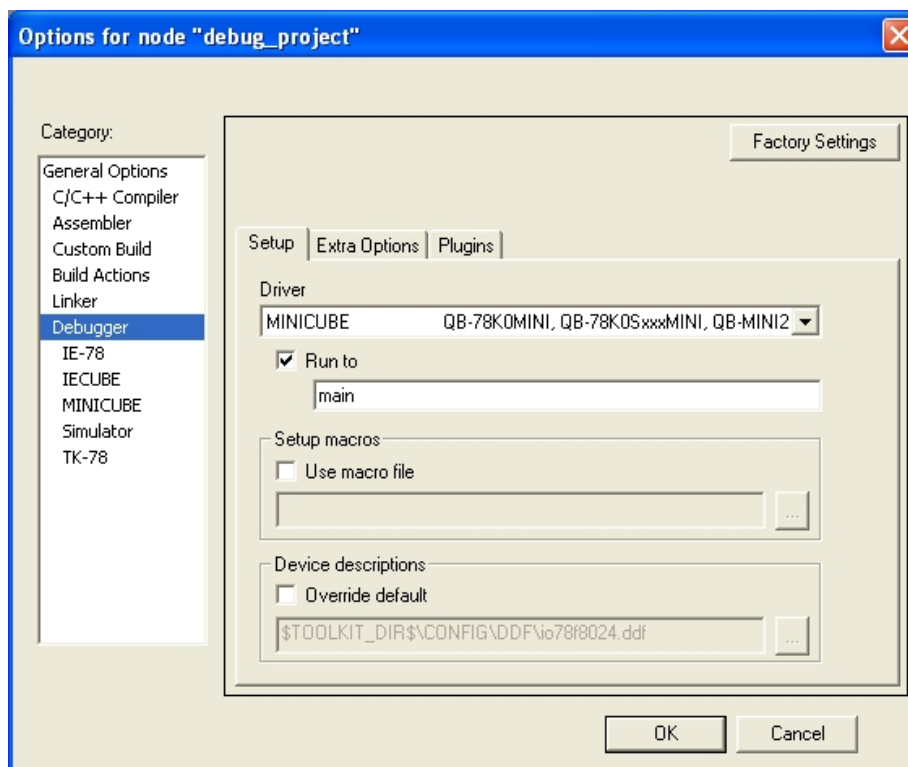

Figure 56: IAR Embedded Workbench Debugger Options

5. Exchange the linker command file. **Project** → **Options** → **Linker** → **Config** → **Override default** and then push the “...” button

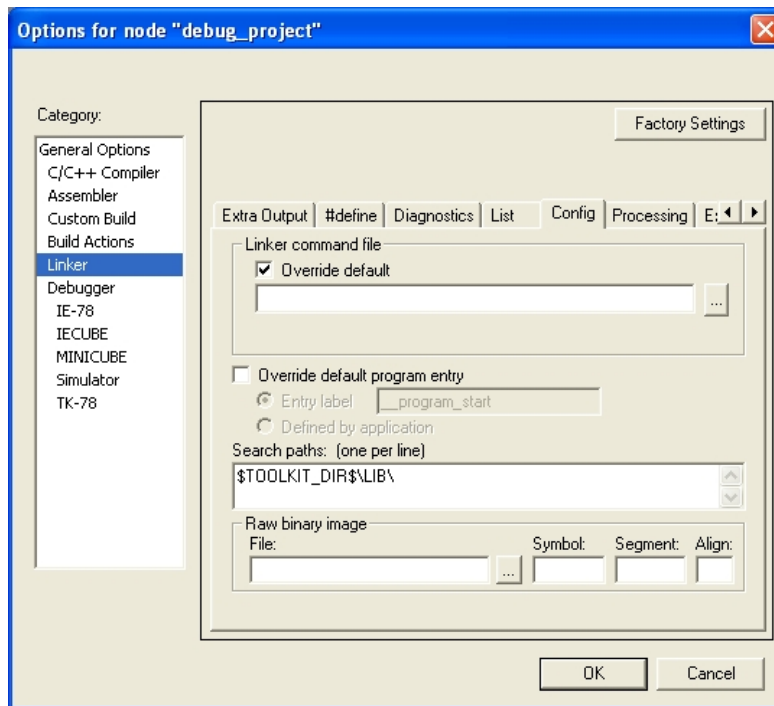

Figure 57: IAR Embedded Workbench Linker Options

5. Select the **Ink78f8024_EV-K0-HCD.xcl** linker command file. This file can be found in the IAR Embedded Workbench folder **C:\Program Files\IAR Systems\Embedded Workbench Kickstart 5.0\78k\config**

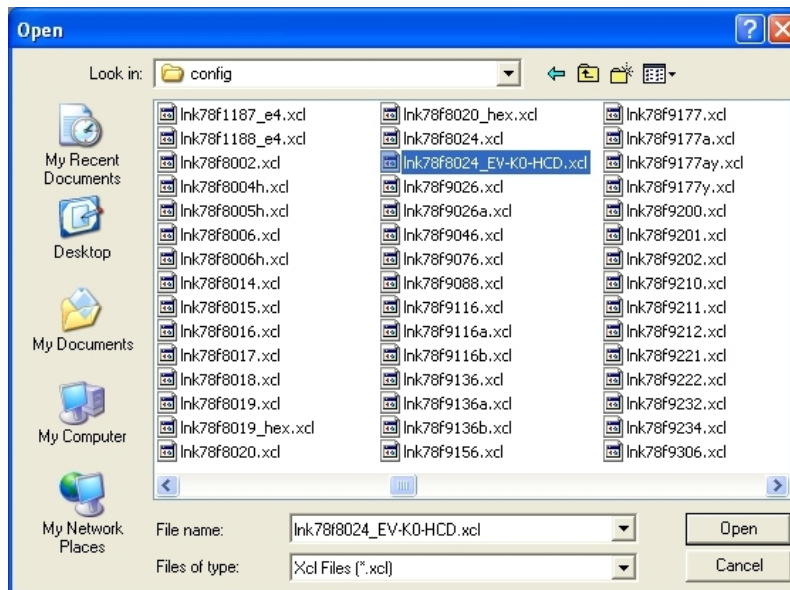

Figure 58: IAR Embedded Workbench .xcl file selection

Note: If you have changed the install location of the IAR Embedded Workbench during installation please refer to the selected location "IAR installation folder"\78K\config

7. Start a Debug session. **Project** → **Debug** Now you should be connected to the target device using the IAR C-SPY debugger.

Note: Make sure to set back the original debug communication DLL from the backup file after finishing the debug session.

10. Cables

10.1 USB interface cable (Mini-B type)

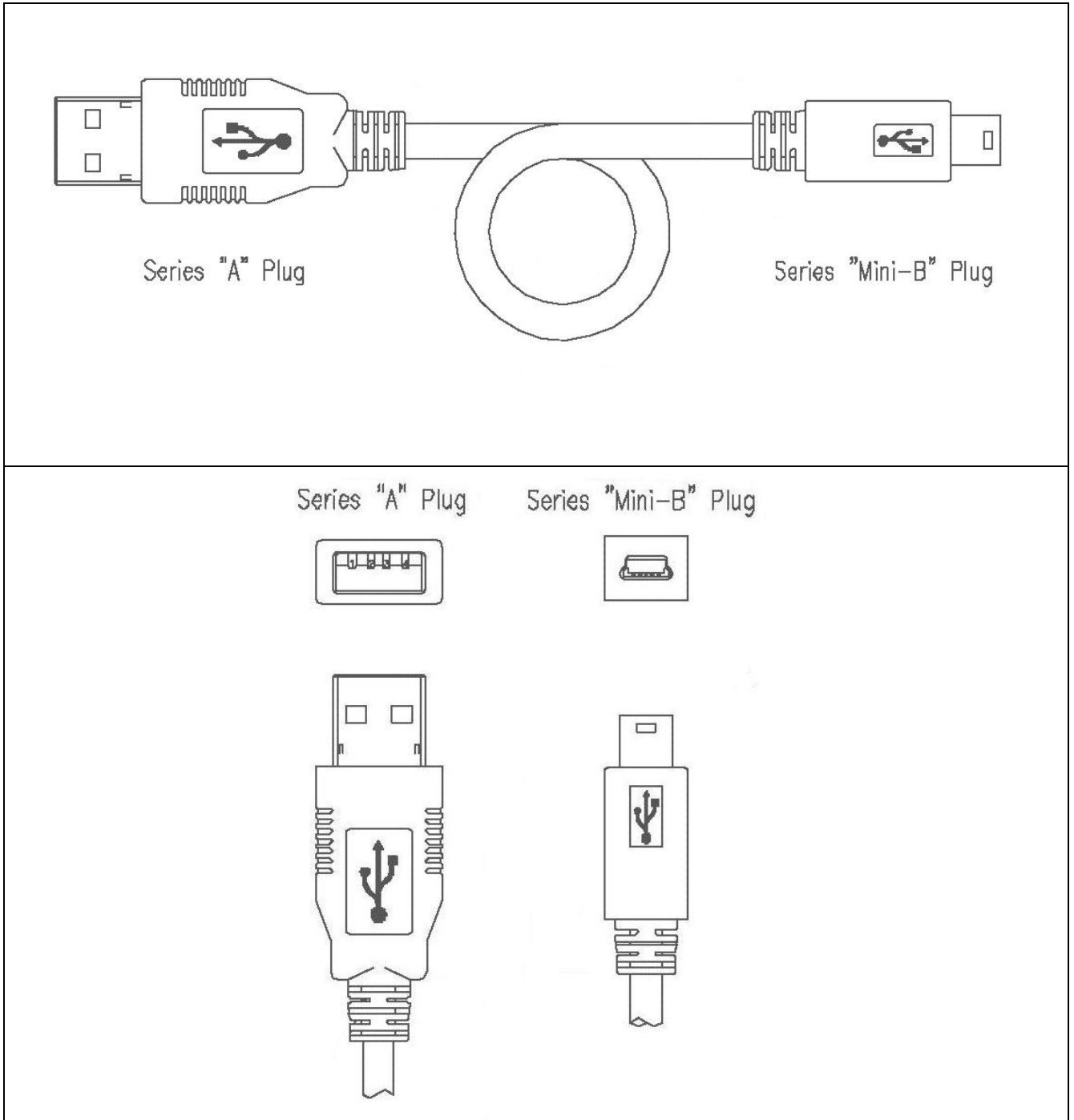

Figure 59: USB interface cable (Mini-B type)

11. Schematics

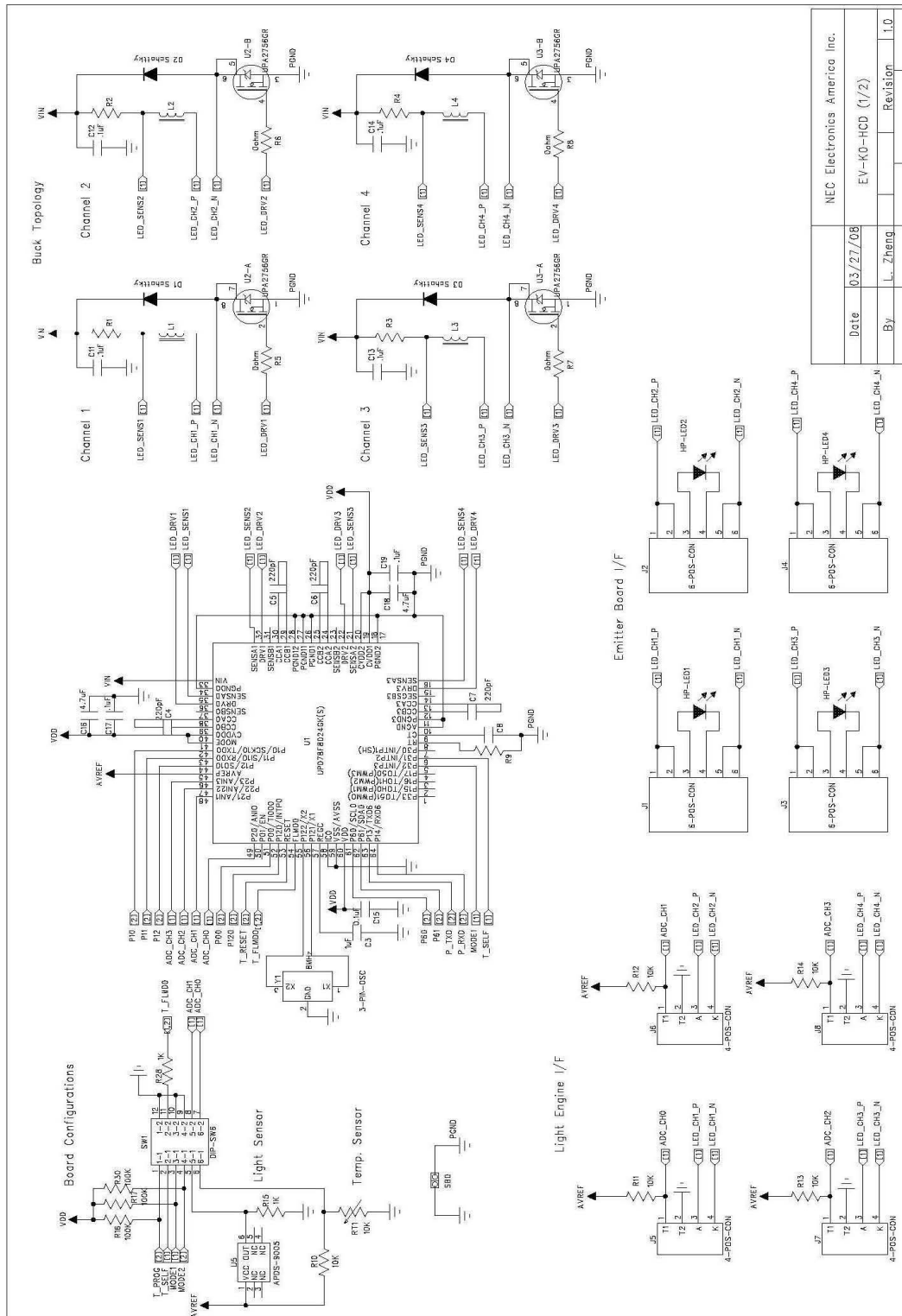

Figure 60: EV-K0-HCD schematics 1 / 2

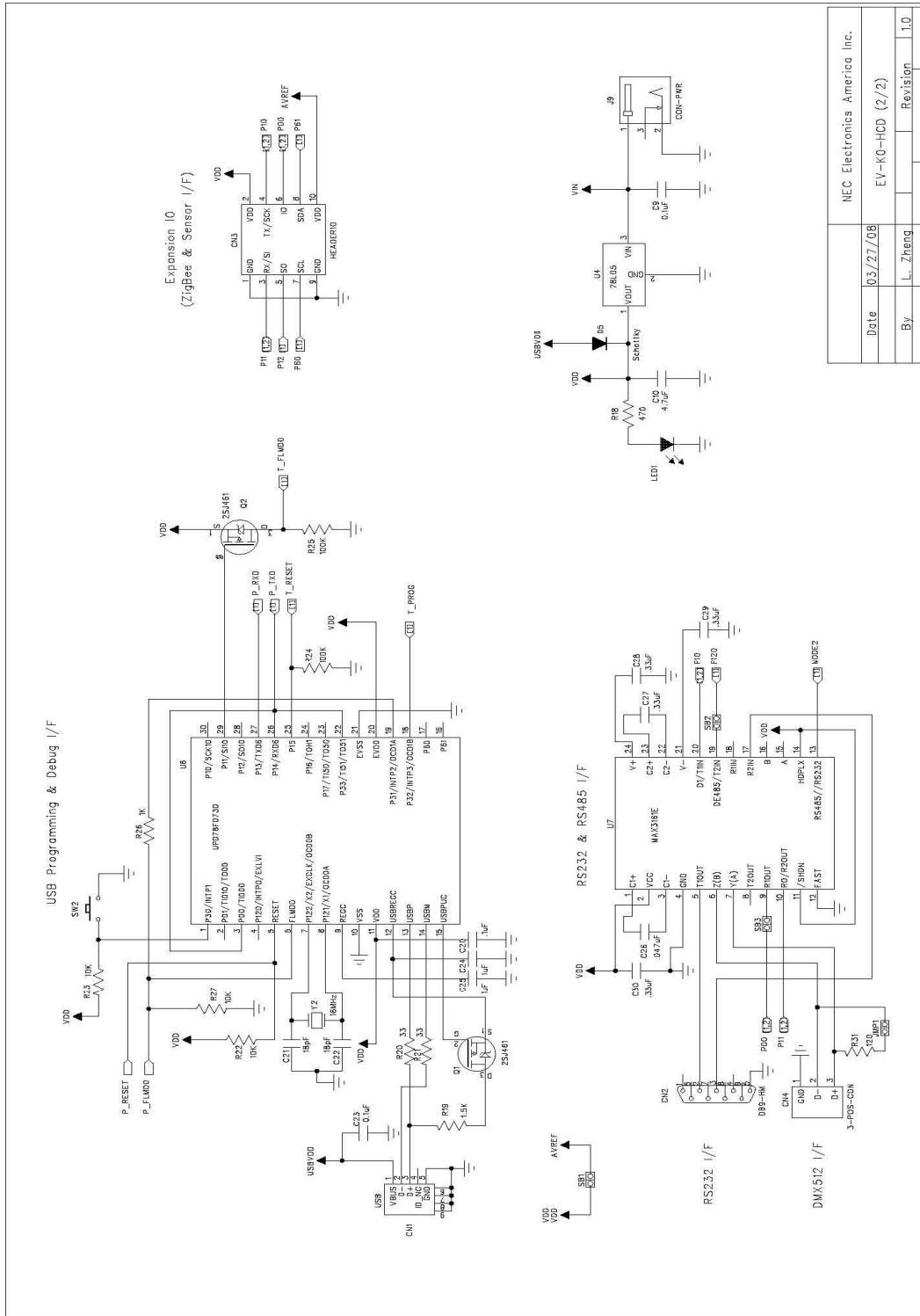

Figure 61: EV-K0-HCD schematics 2 / 2

Date	03/27/08	NEC Electronics America Inc.
By	L. Zheng	EV-K0-HCD (2/2)
Revision	1.0	

12. Bill of materials

	Name	Manufacturer / Part #	Qty.	Description
U1	HCD/LED MCU	NEC Electronics / μ PD78F8024GK	1	64-pin LQFP
U2, U3	MOSFETs	NEC Electronics / μ PA2756GR	2	8-pin SOP, dual-N FET
U4	Voltage regulator	TI / UA78M05CDCYR	1	SOT-223, 5V, 500 mA
U5	Light sensor	Avago / APDS-9005-020	1	6-pin miniature SMD
U6	USB MCU	NEC Electronics / μ PD78F0730MC	1	30-pin SSOP
U7	RS-232/485 tcrv	Maxim / MAX3161EAG+	1	24-pin SSOP
Q1, Q2	MOSFETs	NEC / 2SJ461	2	SC-59, PFET
D1, D2, D3, D4	Schottky diode	ST / STPS140A	4	1A/40V, SMA footprint
D5	Schottky diode	Diodes / B0520LW-7-F	1	500 mA, 0.385 Vf, SOD-123
R1, R2, R3, R4	Current sensor	KOA / SR732BTTER332F	4	0.332 Ω , 1/4W, 1206 SMD, 1%, 100 PPM
HP-LED1	High power LED	Lumileds/ LXML-PD01-0040	1	LUXEON Rebel Red
HP-LED2	High power LED	Lumileds / LXML-PM01-0050	1	LUXEON Rebel Green
HP-LED3	High power LED	Lumileds / LXML-PB01-0023	1	LUXEON Rebel Blue
HP-LED4	High power LED	Lumileds / LXML-PWC1-0070	1	LUXEON Rebel White
L1, L2, L3, L4	Inductor	TDK / SLF6028T-470MR59-PF	4	47 μ H \pm 20%, 590 mA, 210m Ω , 6028 SMD
J1, J2, J3, J4	LED board connector	Tyco / 5535676-5	4	6-position receptacle, 0.1" pitch dual dip
J5, J6, J7, J8	Light engine connector	Phoenix Contact / 1727036	4	4 POS 3.8 1 MM PCB GRN
J9	Power Jack	CUI / PJ-102A	1	2.1 mm barrel, internal switch
CN1	USB connector	Hirose / UX60A-MB-5ST	1	Mini-USB, type B, 5-position SMD
CN2	RS-232 connector	Tyco / 1734352-1	1	DB9-M, through-hole right angle
CN3	Expansion IO	Hirose / DF11-10DS-2DSA(05)	1	2 \times 5 , 2 mm pitch
CN4	RS-485 connector	Phoenix Contact / 1727023	1	3POS 3.81MM PCB GRN
JMP1	Jumper		1	2POS 0.1" pitch
SW1	Tactile switch	Omron / B3FS-1012	1	SMD
SW2	DIP switch	Omron / A6H-6101	1	6-position, SMD, 1.27 mm pitch
Y1	Ceramic resonator	Murata / CSTLS8M00G53-B0	1	8 MHz, radial
Y2	Crystal	Citizen / HCM49 16.000MABJ-UT	1	HC-49 SMD, 16 MHz, \pm 50 ppm, 18 pF
LED1	Indicator LED	Dialight / 598-8070-107F	1	0603 SMD, green
SB0	Solder bridge		1	0805 footprint
SB1, SB2, SB3	Solder bridge		3	0603 footprint
C21, C22	Capacitor	Kemet / C0603C180J5GACTU	2	18 pF, 0603
C3, C24, C25	Capacitor	Kemet / C0603C105K8PACTU	3	1 μ F, 10V, 0603

	Name	Manufacturer / Part #	Qty.	Description
C4, C5, C6, C7	Capacitor	Kemet / C0603C221K5RACTU	4	220 pF, 50V, 0603
C8	Capacitor	Kemet / C0603C101J5GACTU	1	100 pF, 0603
C9, C11, C12, C13, C14, C15, C17, C19, C20, C23	Capacitor	Kemet / C0603C104K5RACTU	10	0.1 μ F, 50V, 0603
C10, C16, C18, C31, C32	Capacitor	Kemet / C0805C475K8PACTU	5	4.7 μ F, 10V, 0805
C26	Capacitor	TDK / C1608X7R1E473K	1	0.047 μ F, 0603
C27, C28, C29, C30	Capacitor	Kemet / C0603C334K8PACTU	4	0.33 μ F, 0603
R5, R6, R7, R8	Resistor	Bourns / CR0603-J/-000ELF	4	0 Ω , 0603
R9	Resistor	Vishay / CRCW060311K0FKEA	1	11 k Ω , 0603
R10, R11, R12, R13, R14, R22, R23, R27	Resistor	Vishay / CRCW060310K0FKEA	8	10 k Ω , 1%, 0603
R15, R26, R28	Resistor	Vishay / CRCW06031K00FKEB	3	1 k Ω , 1%, 0603
R16, R17, R24, R25, R30	Resistor	Vishay / CRCW0603100KFKEB	5	100 k Ω , 0603
R18	Resistor	Vishay / CRCW0603470RJNEA	1	470 Ω , 0603
R19	Resistor	Vishay / CRCW06031K50FKEA	1	1.5 k Ω , 0603
R20, R21	Resistor	Vishay / CRCW060333R0FKEA	2	33 Ω , 0603
R31	Resistor	KOA / RK73B2ETTD111J	1	110 Ω , 1210, 1/2 watt
RT1	Thermistor	Murata / NCP21XV103J03RA	1	NTC, 10 k Ω , 0805

Table 8: Bill of materials EV-K0-HCD board

13. EV-K0-HCD Board Assembly

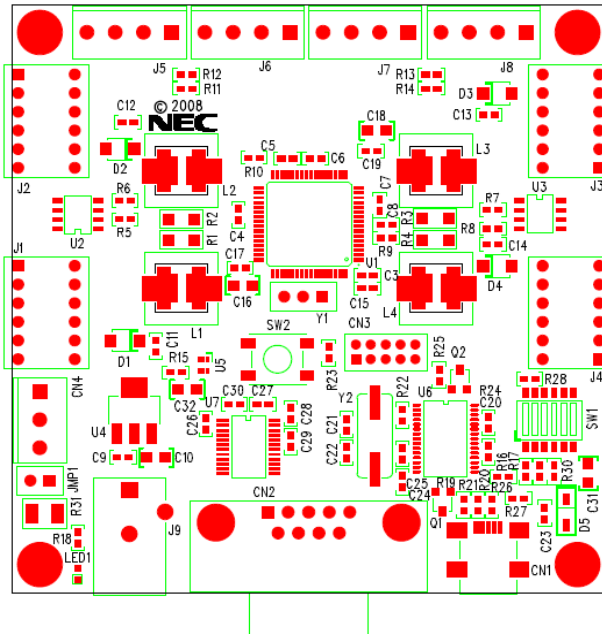

Figure 62: EV-K0-HCD Top Assembly

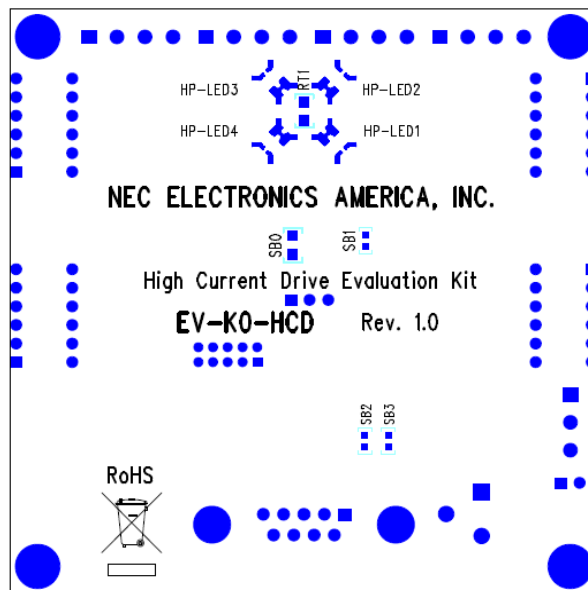

Figure 63: EV-K0-HCD Bottom Assembly

14. Board Layout

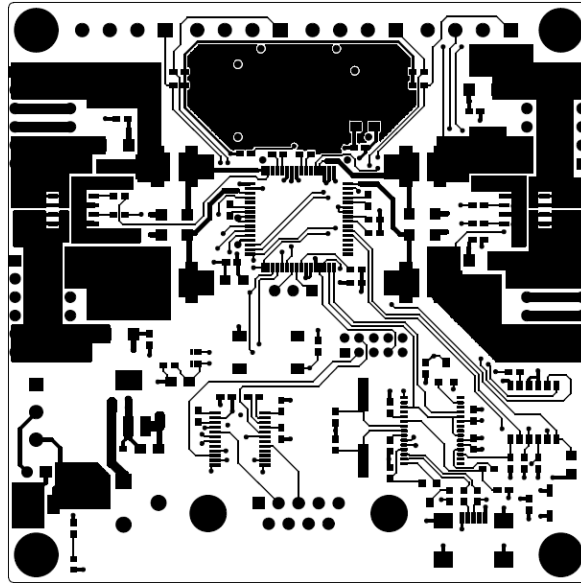

Figure 64: EV-K0-HCD Top Layer

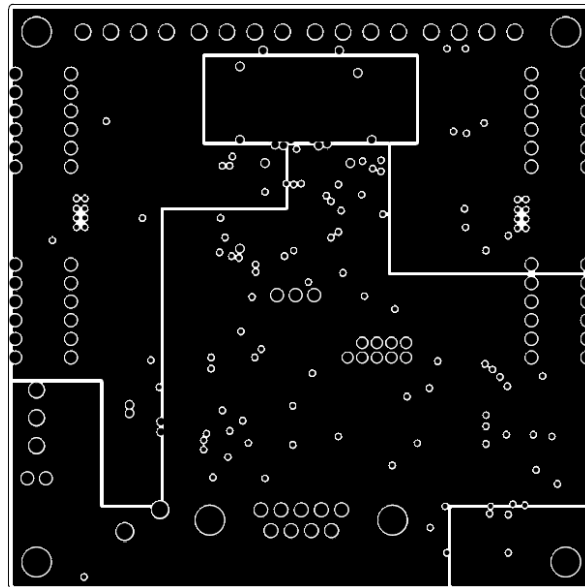

Figure 65: EV-K0-HCD Layer 1

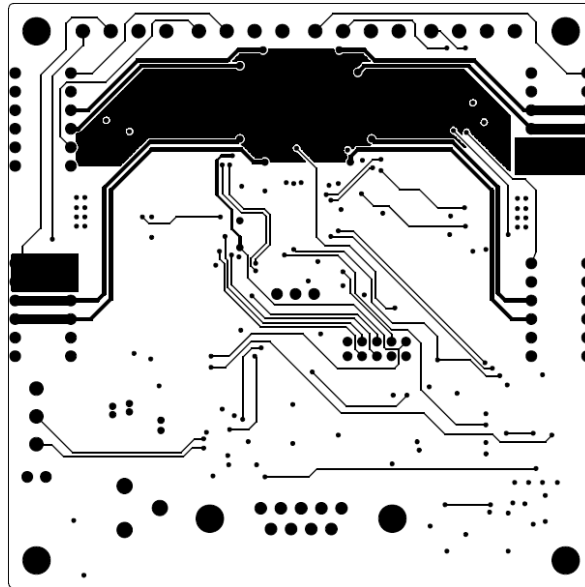

Figure 66: EV-K0-HCD Board Layer 2

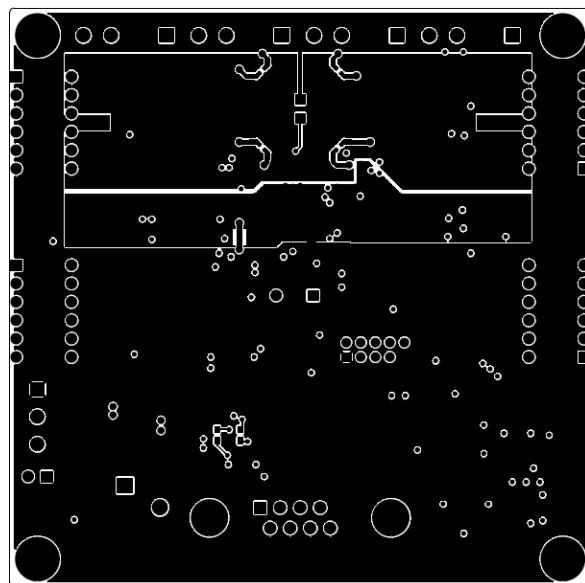

Figure 67: EV-K0-HCD Bottom Layer

[MEMO]