

## Ideal for Workpiece Position and Original Pressure Checking

- The 0 to 100 kPa model can be used for workpiece position checking.
- The 0 to 1MPa model is ideal for original pressure checking.
- Degree of protection conforms to IEC IP54.



 Be sure to read *Safety Precautions* on page 6.

## Ordering Information

Pressure range		ON/OFF output		Linear output
		NPN open collector	PNP open collector	
Positive pressure	0 to 1 MPa	<b>E8EB-10C</b>	<b>E8EB-10B</b>	1 to 5 V
Positive pressure	0 to 100 kPa	<b>E8EB-01C</b>	<b>E8EB-01B</b>	
Negative pressure	0 to -100 kPa	<b>E8EB-N0C2B</b>	<b>E8EB-N0B2B</b>	

## Ratings and Specifications

Item	Model	E8EB-10C	E8EB-10B	E8EB-01C	E8EB-01B	E8EB -N0C2B*	E8EB -N0B2B*
Power supply voltage		24 VDC $\pm 10\%$ with a ripple (p-p) of 5% max.					
Current consumption		20 mA max.					
Pressure type		Gauge pressure					
Permissible pressure range		0 to 1 MPa		0 to 100 kPa		0 to -100 kPa	
Pressure setting range		0 to 1 MPa		0 to 100 kPa		0 to -100 kPa	
Withstand pressure		2 MPa		290 kPa			
Applicable fluid		Noncorrosive and nonflammable gases					
Repeat accuracy (ON/OFF output)		$\pm 1\%$ FS max.					
Accuracy (linear output)		$\pm 3\%$ FS max.					
Hysteresis (linear output)		$\pm 1\%$ FS max.					
Differential travel (ON/OFF output)		0.4 to 1.6% FS max.					
Linearity (linear output)		$\pm 1\%$ FS max.					
Response time		5 ms max.					
Linear output		1 to 5 V with an output impedance of 20 $\Omega$ and a permissible resistive load of 10 k $\Omega$ min.					
ON/OFF output		NPN open collector	PNP open collector	NPN open collector	PNP open collector	NPN open collector	PNP open collector
	Load current	80 mA max.					
	Output applied voltage	30 VDC max.					
	Residual voltage	NPN: 0.4 V max. (at the load current of 20 mA) and 1 V max. (at the load current of 80 mA) PNP: 1.5 V max. (at the load current of 20 mA) and 2 V max. (at the load current of 80 mA)					
Indicator		Operation indicator (red)					
Ambient temperature		Operating: -10°C to 55°C (with no icing) Storage: -25°C to 70°C (with no icing)					
Ambient humidity		Operating: 35% to 85% (with no condensation)					
Temperature influence		$\pm 0.12\%$ FS/°C between 0°C and 50°C		$\pm 0.2\%$ FS/°C between 0°C and 50°C			
		$\pm 0.2\%$ FS/°C max. between -10°C and 0°C or 50°C and 55°C		$\pm 0.3\%$ FS/°C max. between -10°C and 0°C or 50°C and 55°C			
Voltage influence		$\pm 1\%$ FS max.					
Insulation resistance		100 M $\Omega$ min. (at 500 VDC) between current carry parts and case					
Dielectric strength		500 VAC for 1 min between current carry parts and case					
Vibration resistance		Destruction: 10 to 500 Hz, 1.5-mm double amplitude or 100 m/s <sup>2</sup> whichever is smaller, for 2 hours each in X, Y, and Z directions					
Shock resistance		Destruction: 1,000 m/s <sup>2</sup> 3 times each in X, Y, and Z directions					
Degree of protection		IEC 60529 IP54					
Pressure inlet		Rc(PT)1/8					
Connection method		Pre-wired (standard cable length: 2 m)					
Weight (packed state)		Approx. 120 g					
Pressure port material		Zinc die-cast					
Accessories		Instruction manual					

\* These models are negative-pressure models.

# Engineering Data (Typical)

### Operating Pressure Fluctuation vs. Temperature E8EB-01C

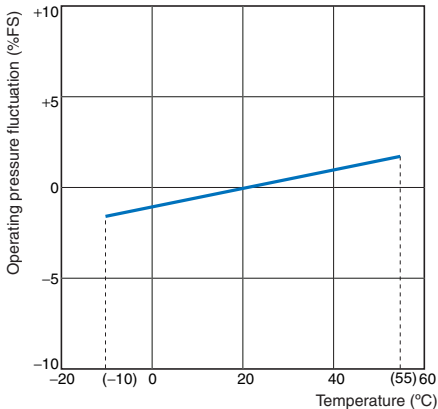

### Differential Travel vs. Pressure E8EB-01C

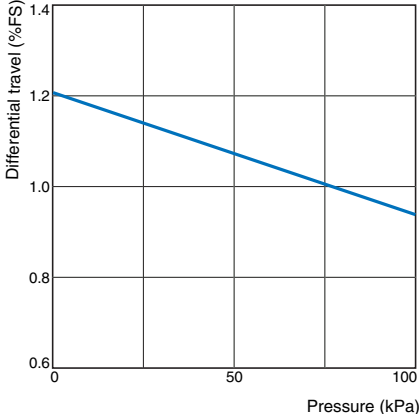

### Operating Pressure Fluctuation vs. Voltage E8EB-01C

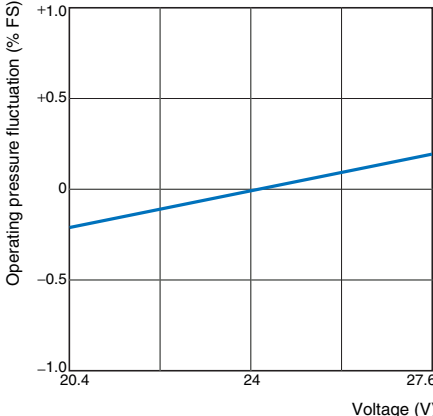

### Linear Output Voltage vs. Pressure E8EB

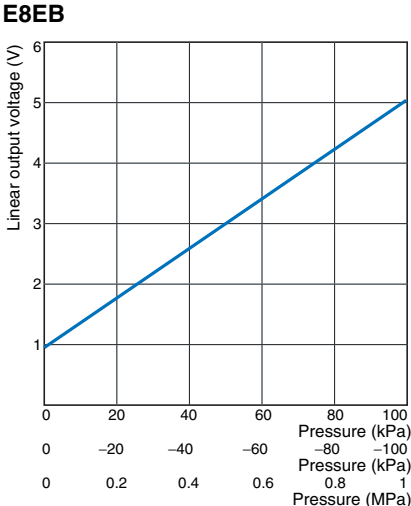

### Linear Output Fluctuation vs. Temperature E8EB-01C

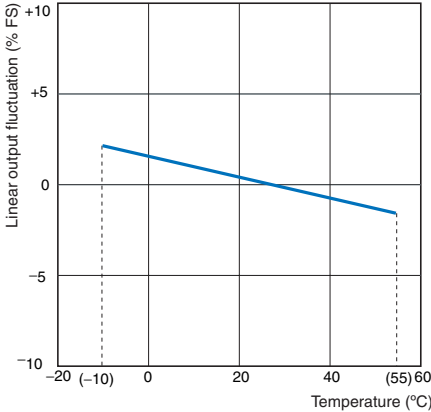

### Linearity E8EB-01C

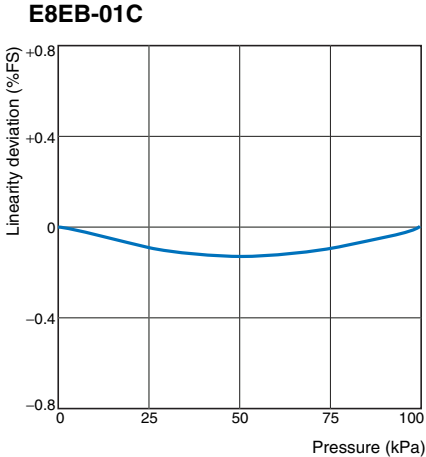

### Linear Output Fluctuation vs. Voltage E8EB-01C

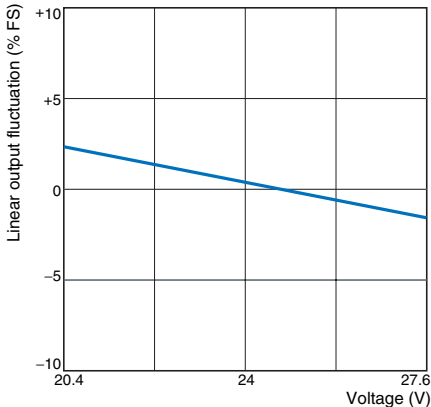

## Gap Measurement

When checking the gap between the workpiece and the nozzle as shown in the illustration, the output of the E8EB varies with the surface roughness of the workpiece or the dimensions of the nozzle.

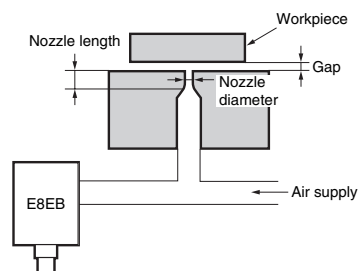

### Examples with E8EB-01C (Typical) Influence of Surface Roughness of Workpieces

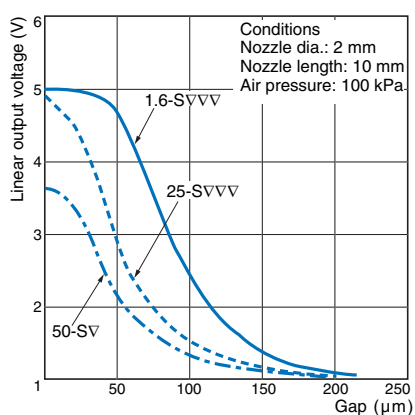

- The output varies with the surface roughness of the workpiece even though the gap is constant.
- The rougher the surface of the workpiece is, the more noticeable the variation of output is with a small gap. The variation rate versus gap change is not large in such cases.

### Influence of Nozzle Diameter

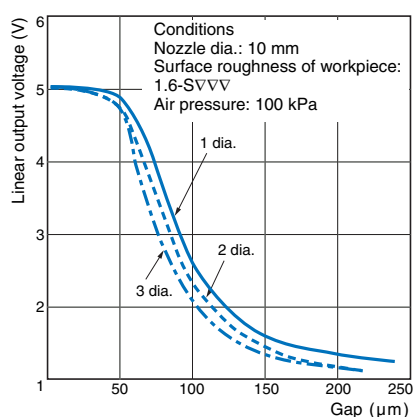

- The larger the nozzle diameter is, the larger the variation rate of output versus gap change is.

### Influence of Nozzle Length

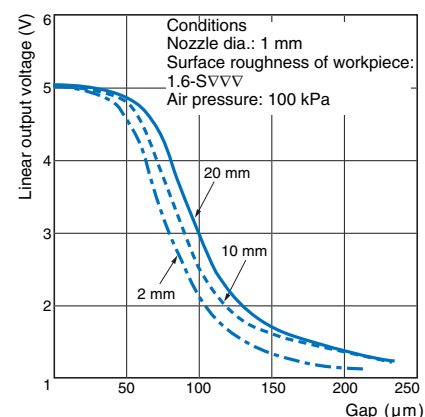

- The smaller the nozzle length is, the larger the variation rate of output versus gap change is.

I/O Circuit Diagrams

NPN Output

Model	Timing Charts	Output Circuit
<p>E8EB-10C E8EB-01C</p>		
<p>E8EB-N0C2B</p>		

PNP Output

Model	Timing Charts	Output Circuit
<p>E8EB-10B E8EB-01B</p>		
<p>E8EB-N0B2B</p>		

## Safety Precautions

### ⚠ WARNING

This product is not designed or rated for ensuring safety of persons.

Do not use it for such purposes.



### Precautions for Correct Use

Do not use the product in atmospheres or environments that exceed product ratings.

#### ● Mounting

- If the diaphragm is damaged, the Pressure Sensor will not operate properly. Do not insert a screwdriver or steel wire into the interior of the pressure-sensitive parts through the pressure port.
- The pressure inlet has an R (PT) 1/8 taper screw and M5 female screw that conforms to JIS Standards. Apply sealing tape around the female taper screw so that no pressure leakage will occur.
- The most-suitable wrench is 17 mm in size.
- Make sure that the tightening torque of the M5 female screw is 9.8 N·m or less.

#### ● Adjustment

##### Pressure Setting

- After the pressure is set with the pressure adjuster, cover the adjuster with the rubber bushing so that no dust or any other foreign material will penetrate into the interior of the E8EB.

## Dimensions

(Unit: mm)

### E8EB

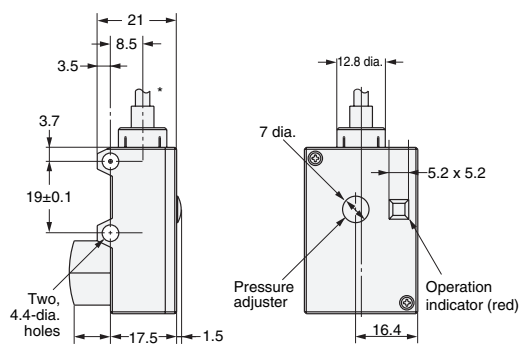
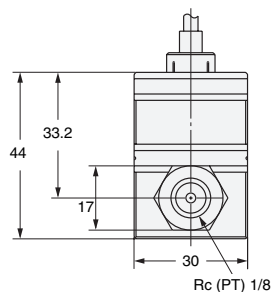
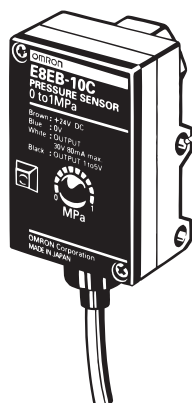

\*3.8-dia. vinyl-insulated round cable with 4 conductors, (Conductor cross-section: 0.2 mm<sup>2</sup>, Insulator diameter: 1.0 mm); Standard length: 2 m

In the interest of product improvement, specifications are subject to change without notice.