

1200 V power Schottky silicon carbide diode

Datasheet - production data

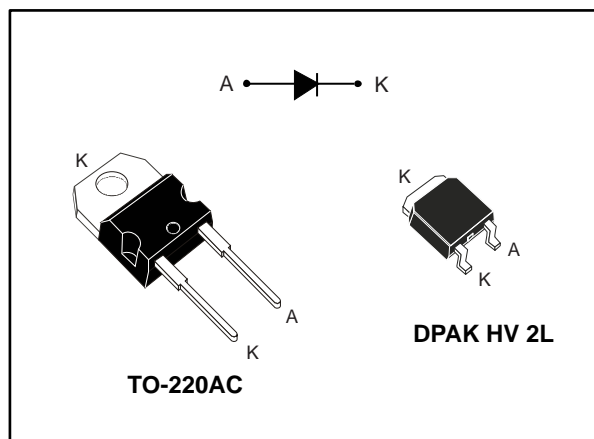

Description

The SiC diode, available in TO-220AC and DPAK HV, is an ultrahigh performance power Schottky rectifier. It is manufactured using a silicon carbide substrate. The wide band-gap material allows the design of a low V_F Schottky diode structure with a 1200 V rating. Due to the Schottky construction, no recovery is shown at turn-off and ringing patterns are negligible. The minimal capacitive turn-off behavior is independent of temperature.

Especially suited for use in PFC and secondary side applications, this ST SiC diode will boost the performance in hard switching conditions. This rectifier will enhance the performance of the targeted application. Its high forward surge capability ensures a good robustness during transient phases.

Features

- No or negligible reverse recovery
- Switching behavior independent of temperature
- Robust high voltage periphery
- Operating T_j from $-40\text{ }^\circ\text{C}$ to $175\text{ }^\circ\text{C}$
- Low V_F
- ECOPACK[®]2 compliant

Table 1: Device summary

Symbol	Value
$I_{F(AV)}$	5 A
V_{RRM}	1200 V
$T_j(\text{max.})$	$175\text{ }^\circ\text{C}$
$V_F(\text{typ.})$	1.35 V

1 Characteristics

Table 2: Absolute ratings (limiting values at 25 °C, unless otherwise specified)

Symbol	Parameter		Value	Unit	
V _{RRM}	Repetitive peak reverse voltage (T _j = -40 °C to +175 °C)		1200	V	
I _{F(RMS)}	Forward rms current		20	A	
I _{F(AV)}	Average forward current	T _C = 160 °C, DC current T _C = 125 °C, DC current	5 10	A	
I _{FRM}	Repetitive peak forward current	T _C = 160 °C, T _j = 175 °C, δ = 0.1	19	A	
I _{FSM}	Surge non repetitive forward current	t _p = 10 ms sinusoidal	T _C = 25 °C	35	A
			T _C = 150 °C	30	
		t _p = 10 μs square	T _C = 25 °C	210	
T _{stg}	Storage temperature range		-65 to +175	°C	
T _j	Operating junction temperature range		-40 to +175	°C	

Table 3: Thermal parameters

Symbol	Parameter	Typ.	Max.	Unit
R _{th(j-c)}	Junction to case	1.0	1.4	°C/W

Table 4: Static electrical characteristics

Symbol	Parameter	Test conditions		Min.	Typ.	Max.	Unit
I _R ⁽¹⁾	Reverse leakage current	T _j = 25 °C	V _R = V _{RRM}	-	2.5	30	μA
		T _j = 150 °C		-	15	200	
V _F ⁽²⁾	Forward voltage drop	T _j = 25 °C	I _F = 5 A	-	1.35	1.50	V
		T _j = 150 °C		-	1.75	2.25	

Notes:

(1)Pulse test: t_p = 10 ms, δ < 2%

(2)Pulse test: t_p = 500 μs, δ < 2%

To evaluate the maximum conduction losses, use the following equation:

$$P = 1.08 \times I_{F(AV)} + 0.233 \times I_{F(RMS)}^2$$

Table 5: Dynamic electrical characteristics

Symbol	Parameter	Test conditions	Min.	Typ.	Max.	Unit
Q _{Cj} ⁽¹⁾	Total capacitive charge	V _R = 800 V	-	36	-	nC
C _j	Total capacitance	V _R = 0 V, T _C = 25 °C, F = 1 MHz	-	450	-	pF
		V _R = 800 V, T _C = 25 °C, F = 1 MHz	-	29	-	

Notes:

(1)Most accurate value for the capacitive charge: $Q_{Cj}(V_R) = \int_0^{V_R} C_j(V)dV$

1.1 Characteristics (curves)

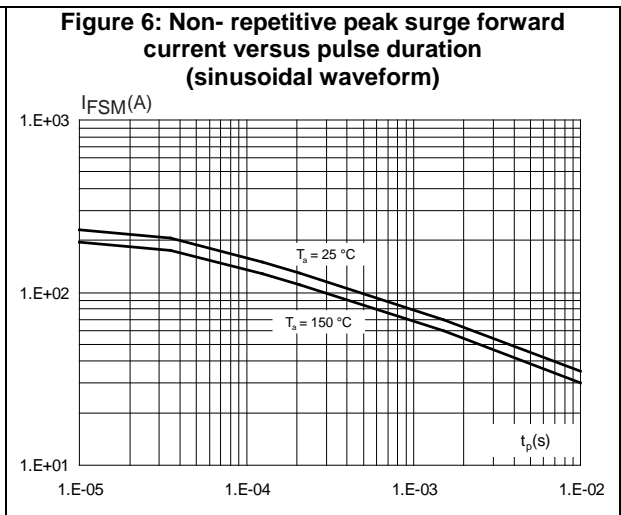
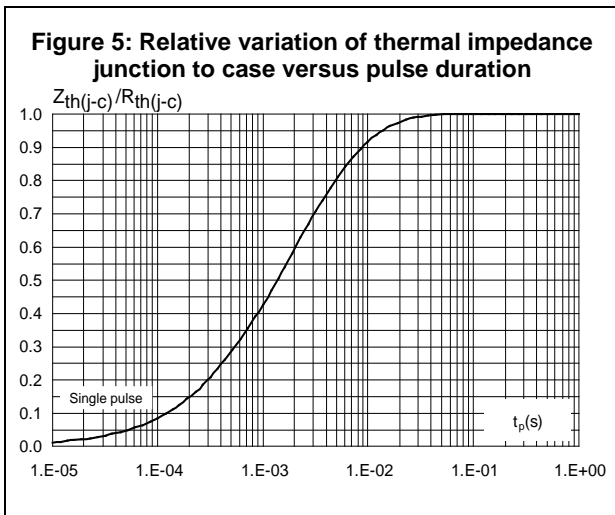
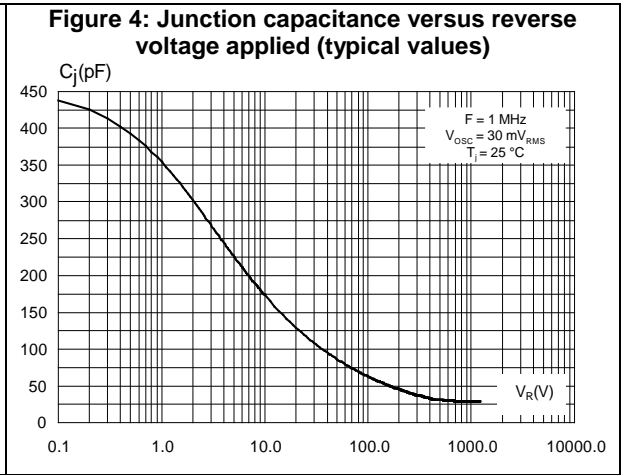
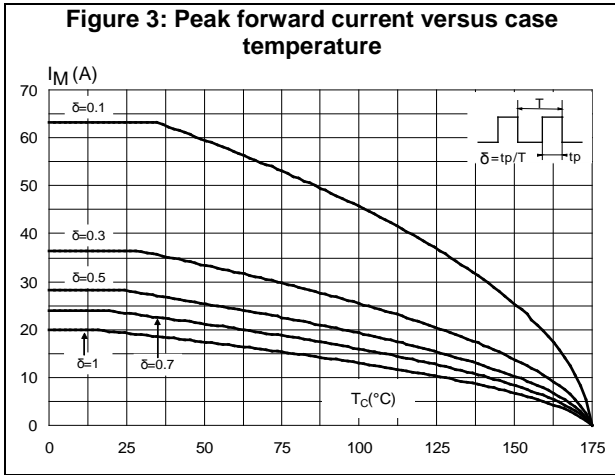
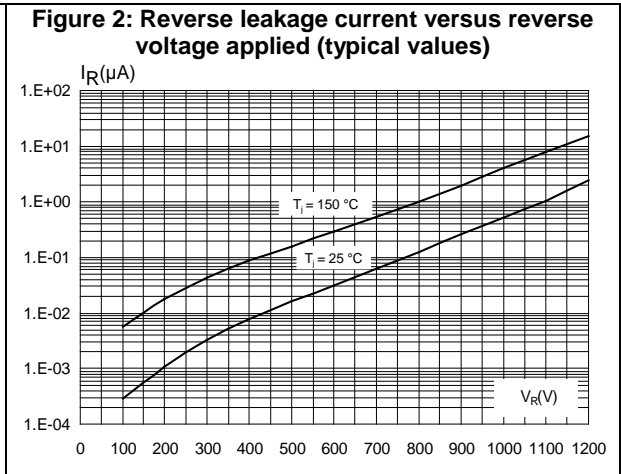
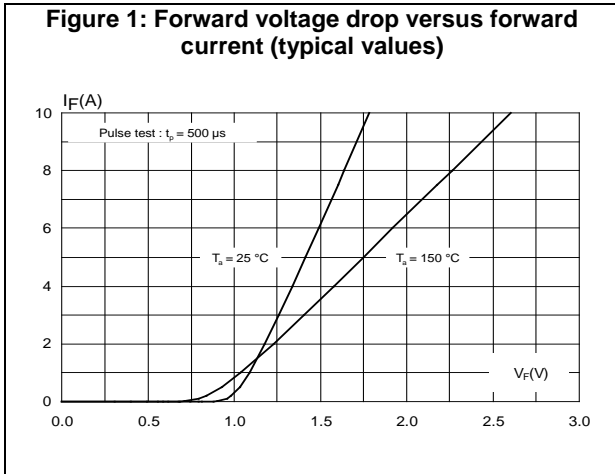

Figure 7: Total capacitive charges versus reverse voltage applied (typical values)

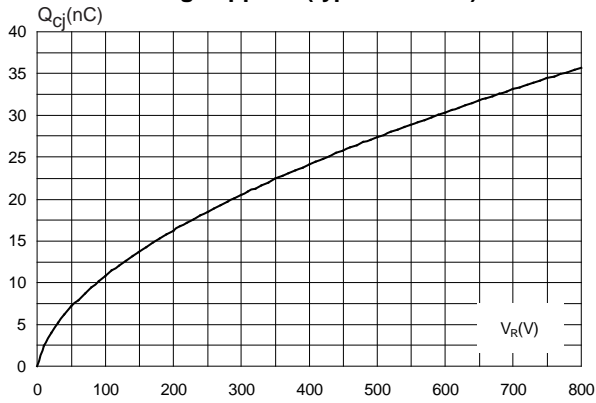
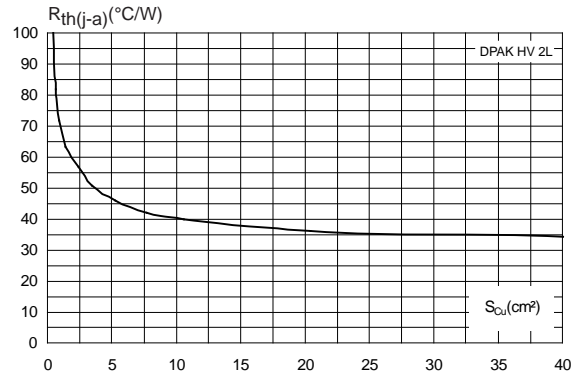

Figure 8: Thermal resistance junction to ambient versus copper surface under tab on epoxy printed board FR4, $e_{Cu} = 35 \mu m$ (typical values)



2 Package information

In order to meet environmental requirements, ST offers these devices in different grades of ECOPACK® packages, depending on their level of environmental compliance. ECOPACK® specifications, grade definitions and product status are available at: www.st.com. ECOPACK® is an ST trademark.

- Epoxy meets UL94, V0
- Cooling method: by conduction (C)
- Recommended torque value: 0.55 N·m
- Maximum torque value: 0.7 N·m

2.1 TO-220AC rectifier package information

Figure 9: TO-220AC package outline

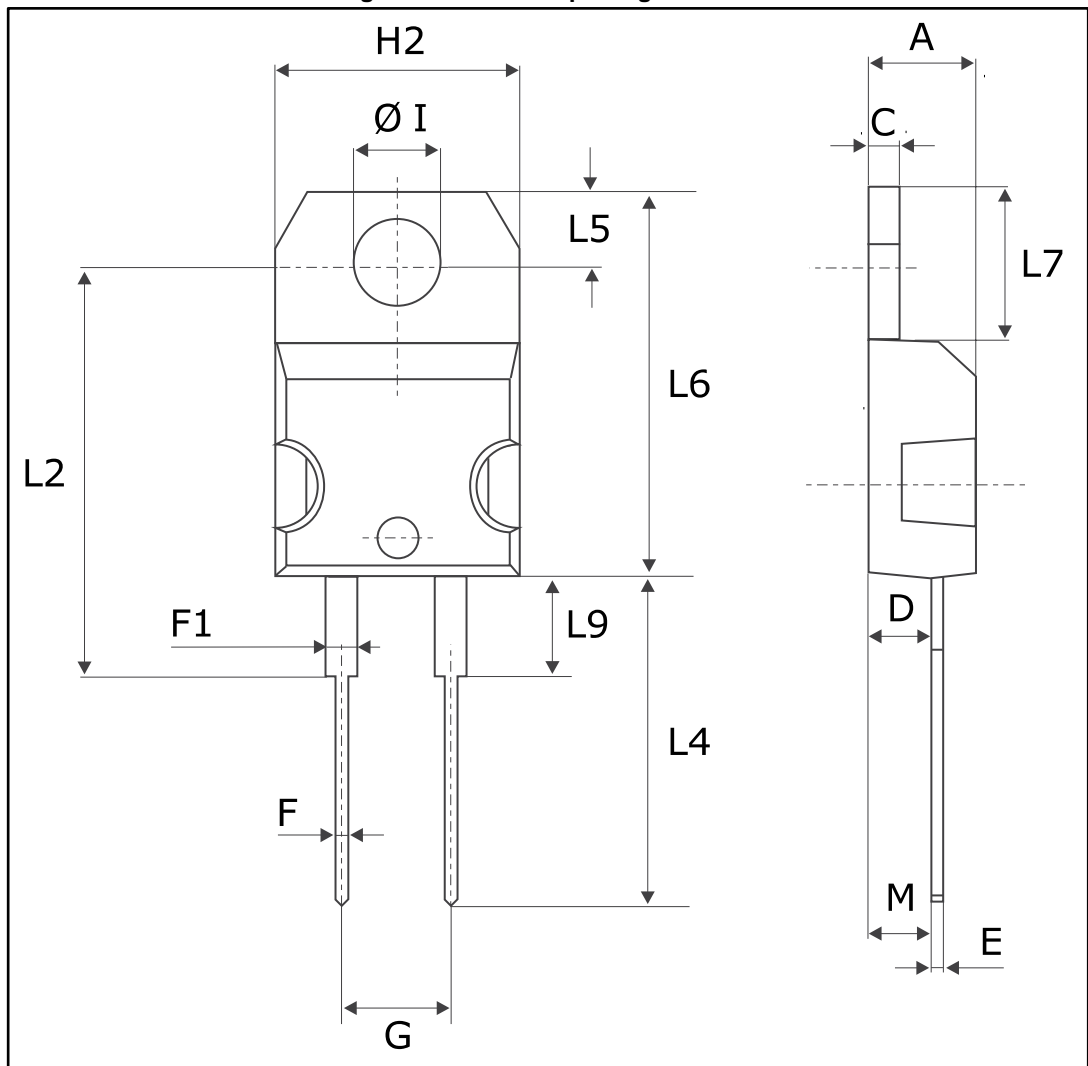

Table 6: TO-220AC package mechanical data

Ref.	Dimensions			
	Millimeters		Inches	
	Min.	Max.	Min.	Max.
A	4.40	4.60	0.173	0.181
C	1.23	1.32	0.048	0.051
D	2.40	2.72	0.094	0.107
E	0.49	0.70	0.019	0.027
F	0.61	0.88	0.024	0.034
F1	1.14	1.70	0.044	0.066
G	4.95	5.15	0.194	0.202
H2	10.00	10.40	0.393	0.409
L2	16.40 typ.		0.645 typ.	
L4	13.00	14.00	0.511	0.551
L5	2.65	2.95	0.104	0.116
L6	15.25	15.75	0.600	0.620
L7	6.20	6.60	0.244	0.259
L9	3.50	3.93	0.137	0.154
M	2.6 typ.		0.102 typ.	
Diam	3.75	3.85	0.147	0.151

2.2 DPAK HV 2L package information

Figure 10: DPAK HV 2L package outline

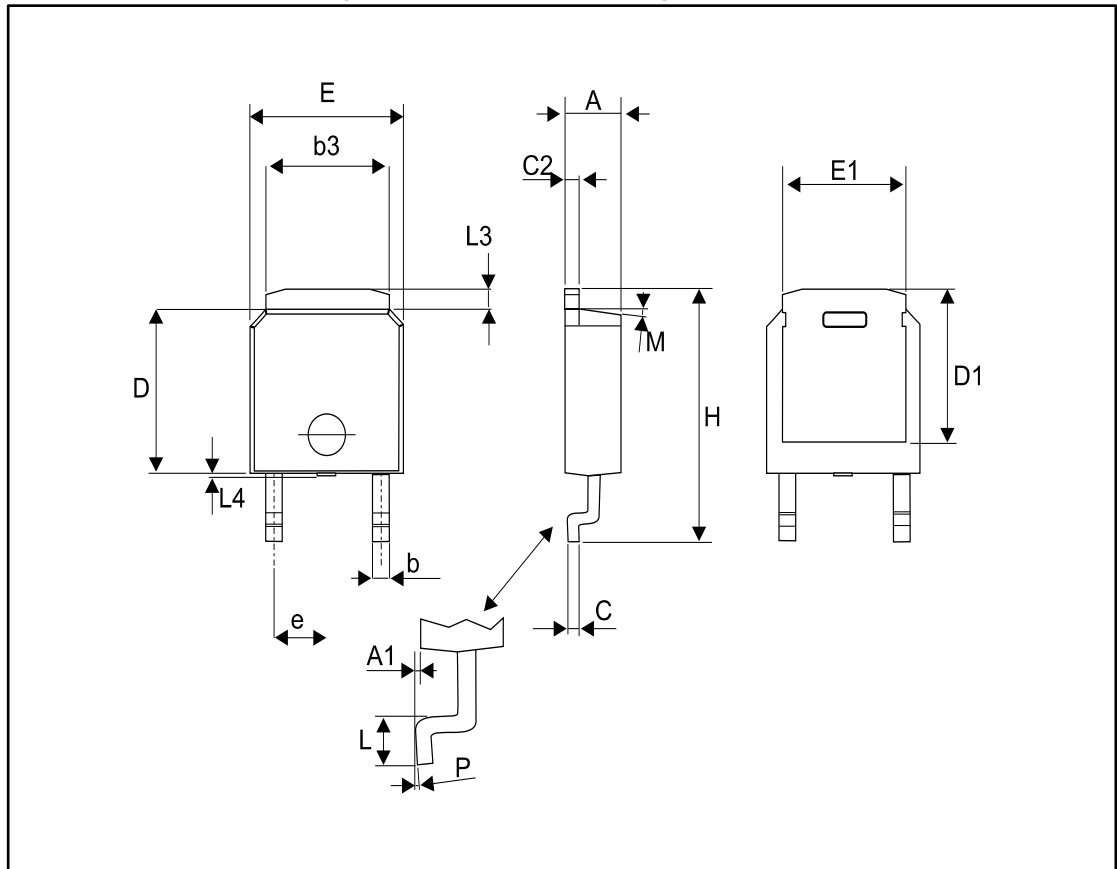

Table 7: DPAK HV 2L package mechanical data

Ref.	Dimensions					
	Millimeters			Inches		
	Min.	Typ.	Max.	Min.	Typ.	Max.
A	2.16	2.29	2.40	0.085	0.090	0.094
A1	0.06	0.08	0.13	0.002	0.003	0.005
b	0.71	0.76	1.07	0.028	0.029	0.030
b3	5.004	5.10	5.21	0.197	0.201	0.205
c	0.46	0.51	0.56	0.018	0.020	0.025
c2	0.76	0.81	0.86	0.029	0.032	0.034
D	5.97	6.10	6.22	0.235	0.240	0.245
D1	5.84 REF			0.230 REF		
E	6.48	6.60	6.73	0.255	0.260	0.265
E1	4.95	5.08	5.21	0.195	0.200	0.205
e	2.29 REF			0.90 REF		
H	9.70	9.83	10.08	0.382	0.387	0.397
L	1.02	1.14	1.40	0.040	0.045	0.055
L3			1.14			0.045
L4 ⁽¹⁾	0.000		0.15	0.000		0.006
M		7°			7°	
P			5°			5°

Notes:

⁽¹⁾Maximum plastic protrusion

Figure 11: Footprint (dimensions in mm)

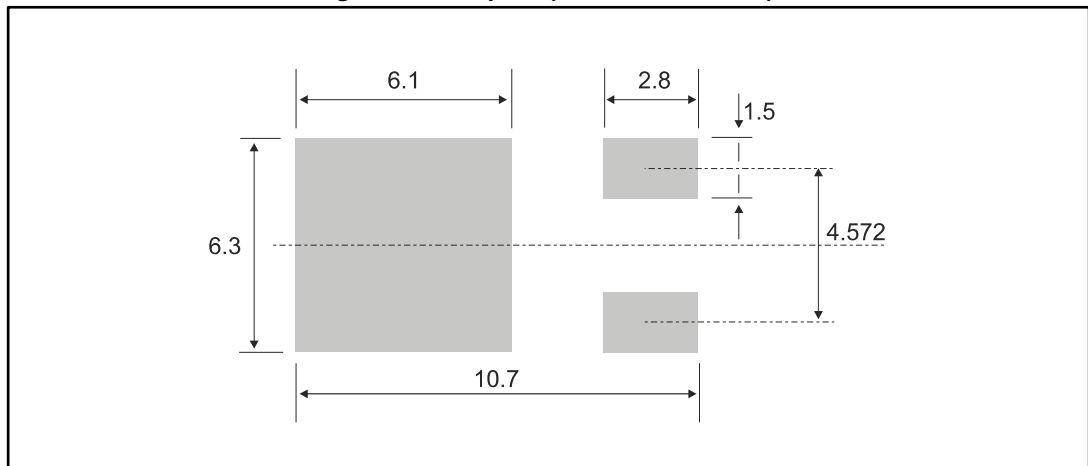

3 Ordering information

Table 8: Ordering information

Order code	Marking	Package	Weight	Base qty.	Delivery mode
STPSC5H12D	STPSC5H12D	TO-220AC	1.86 g	50	Tube
STPSC5H12B-TR1	STPSC 5H12	DPAK HV 2L	0.368 g	2500	Tape and reel

4 Revision history

Table 9: Document revision history

Date	Revision	Changes
24-Jan-2017	1	Initial release.

IMPORTANT NOTICE – PLEASE READ CAREFULLY

STMicroelectronics NV and its subsidiaries ("ST") reserve the right to make changes, corrections, enhancements, modifications, and improvements to ST products and/or to this document at any time without notice. Purchasers should obtain the latest relevant information on ST products before placing orders. ST products are sold pursuant to ST's terms and conditions of sale in place at the time of order acknowledgement.

Purchasers are solely responsible for the choice, selection, and use of ST products and ST assumes no liability for application assistance or the design of Purchasers' products.

No license, express or implied, to any intellectual property right is granted by ST herein.

Resale of ST products with provisions different from the information set forth herein shall void any warranty granted by ST for such product.

ST and the ST logo are trademarks of ST. All other product or service names are the property of their respective owners.

Information in this document supersedes and replaces information previously supplied in any prior versions of this document.

© 2017 STMicroelectronics – All rights reserved