

Gallium Arsenide PHEMT

RF Power Field Effect Transistor

Designed for WLL/MMDS/BWA or UMTS driver applications. Characterized from 500 to 5000 MHz. Device is unmatched and is suitable for use in Class AB Customer Premise Equipment (CPE) applications.

- Typical Single-Carrier W-CDMA Performance: $V_{DD} = 12$ Volts, $I_{DQ} = 55$ mA, $P_{out} = 300$ mWatts Avg., 3550 MHz, Channel Bandwidth = 3.84 MHz, PAR = 8.5 dB @ 0.01% Probability on CCDF.
 Power Gain — 10.8 dB
 Drain Efficiency — 24.5%
 ACPR @ 5 MHz Offset — -43 dBc in 3.84 MHz Channel Bandwidth
- 3 Watts P1dB @ 3550 MHz, CW
- Excellent Phase Linearity and Group Delay Characteristics
- High Gain, High Efficiency and High Linearity
- RoHS Compliant
- In Tape and Reel. T1 Suffix = 1000 Units per 12 mm, 7 inch Reel.

MRFG35003ANT1

**3.5 GHz, 3 W, 12 V
 POWER FET
 GaAs PHEMT**

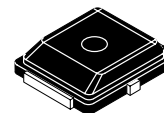

**CASE 466-03, STYLE 1
 PLD-1.5
 PLASTIC**

Table 1. Maximum Ratings

Rating	Symbol	Value	Unit
Drain-Source Voltage	V_{DSS}	15	Vdc
Gate-Source Voltage	V_{GS}	-5	Vdc
RF Input Power	P_{in}	29	dBm
Storage Temperature Range	T_{stg}	-65 to +150	°C
Channel Temperature ⁽¹⁾	T_{ch}	175	°C

Table 2. Thermal Characteristics

Characteristic	Symbol	Value ⁽²⁾	Unit
Thermal Resistance, Junction to Case	$R_{\theta JC}$	15.9	°C/W

1. For reliable operation, the operating channel temperature should not exceed 150°C.
2. Refer to AN1955, *Thermal Measurement Methodology of RF Power Amplifiers*. Go to <http://www.freescale.com/rf>. Select Documentation/Application Notes - AN1955.

Table 3. ESD Protection Characteristics

Test Methodology	Class
Human Body Model (per JESD22-A114)	1C (Minimum)
Machine Model (per EIA/JESD22-A115)	A (Minimum)
Charge Device Model (per JESD22-C101)	IV (Minimum)

Table 4. Moisture Sensitivity Level

Test Methodology	Rating	Package Peak Temperature	Unit
Per JESD22-A113, IPC/JEDEC J-STD-020	3	260	°C

Table 5. Electrical Characteristics ($T_A = 25^\circ\text{C}$ unless otherwise noted)

Characteristic	Symbol	Min	Typ	Max	Unit
Saturated Drain Current ($V_{DS} = 3.5\text{ Vdc}$, $V_{GS} = 0\text{ Vdc}$)	I_{DSS}	—	1.3	—	Adc
Off State Leakage Current ($V_{GS} = -0.4\text{ Vdc}$, $V_{DS} = 0\text{ Vdc}$)	I_{GSS}	—	< 1	100	μAdc
Off State Drain Current ($V_{DS} = 12\text{ Vdc}$, $V_{GS} = -2.5\text{ Vdc}$)	I_{DSO}	—	—	450	μAdc
Off State Current ($V_{DS} = 28.5\text{ Vdc}$, $V_{GS} = -2.5\text{ Vdc}$)	I_{DSX}	—	2	7	mAdc
Gate-Source Cut-off Voltage ($V_{DS} = 3.5\text{ Vdc}$, $I_{DS} = 6.5\text{ mA}$)	$V_{GS(th)}$	-1.2	-0.9	-0.7	Vdc
Quiescent Gate Voltage ($V_{DS} = 12\text{ Vdc}$, $I_D = 80\text{ mA}$)	$V_{GS(Q)}$	-1.2	-0.9	-0.7	Vdc

Functional Tests (In Freescale Test Fixture, 50 ohm system) $V_{DD} = 12\text{ Vdc}$, $I_{DQ} = 55\text{ mA}$, $P_{out} = 300\text{ mWatts Avg.}$, $f = 3550\text{ MHz}$, Single-Carrier W-CDMA, 3.84 MHz Channel Bandwidth Carrier. ACPR measured in 3.84 MHz Channel Bandwidth @ $\pm 5\text{ MHz}$ Offset. PAR = 8.5 dB @ 0.01% Probability on CCDF.

Power Gain	G_{ps}	9.5	10.8	—	dB
Drain Efficiency	η_D	22	24.5	—	%
Adjacent Channel Power Ratio	ACPR	—	-43	-40	dBc

Typical RF Performance (In Freescale Test Fixture, 50 ohm system) $V_{DD} = 12\text{ Vdc}$, $I_{DQ} = 55\text{ mA}$, $f = 3550\text{ MHz}$

Output Power, 1 dB Compression Point, CW	P_{1dB}	—	3	—	W
--	-----------	---	---	---	---

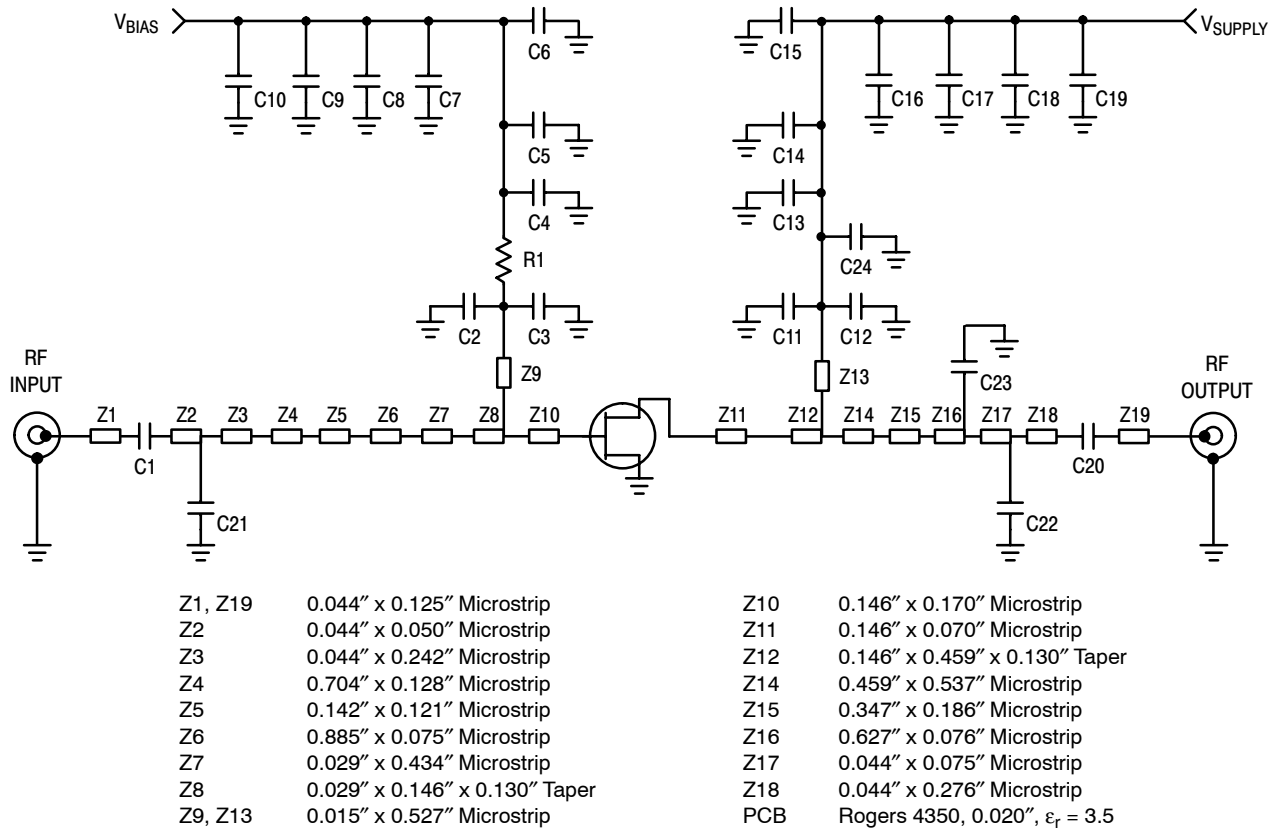

Figure 1. MRFG35003ANT1 Test Circuit Schematic

Table 6. MRFG35003ANT1 Test Circuit Component Designations and Values

Part	Description	Part Number	Manufacturer
C1, C20	7.5 pF Chip Capacitors	ATC100A7R5JT150XT	ATC
C2, C3, C11, C12	3.9 pF Chip Capacitors	08051J3R9BBS	AVX
C4, C13	10 pF Chip Capacitors	ATC100A100JT150XT	ATC
C5, C14	0.01 μ F Chip Capacitors	GRM1881X1H103JA01	Murata
C6, C15	100 pF Chip Capacitors	ATC100B101JT500XT	ATC
C7, C16	1000 pF Chip Capacitors	ATC100B102JT50XT	ATC
C8, C17	39K pF Chip Capacitors	ATC200B393KT50XT	ATC
C9, C18	0.01 μ F Chip Capacitors	ATC200B103KT50XT	ATC
C10, C19	10 μ F Chip Capacitors	GRM55DR61H106KA88B	Murata
C21, C22, C23	0.4 pF Chip Capacitors	08051J0R4ABS	AVX
C24	5.6 pF Chip Capacitor	08051J5R6BBS	AVX
R1	100 Ω , 1/4 W Chip Resistor	ERJ-8GEYJ101V	Panasonic

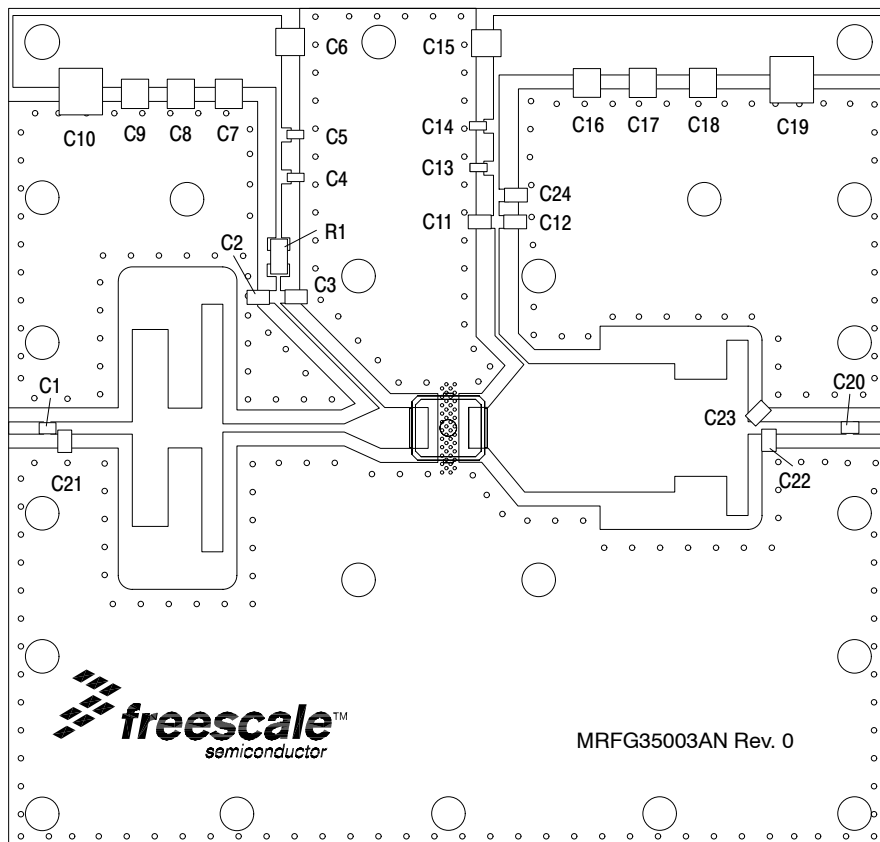

Figure 2. MRFG35003ANT1 Test Circuit Component Layout

TYPICAL CHARACTERISTICS

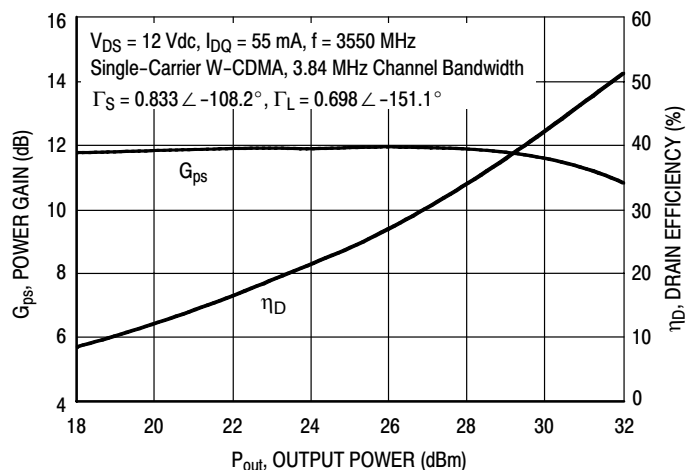

Figure 3. Single-Carrier W-CDMA Power Gain and Drain Efficiency versus Output Power

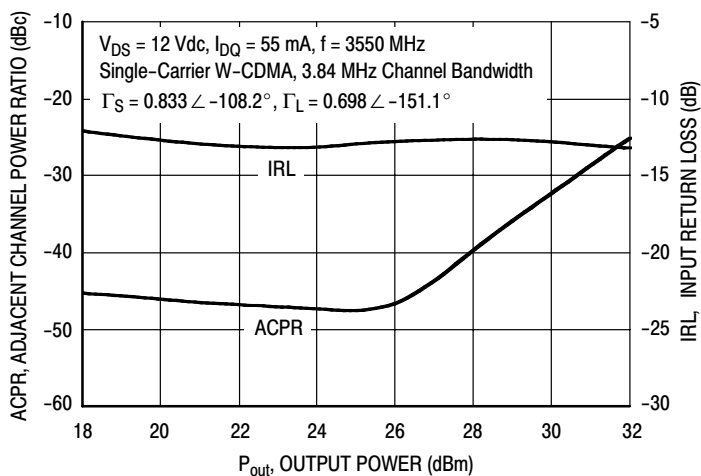

Figure 4. Single-Carrier W-CDMA ACPR and Input Return Loss versus Output Power

NOTE: All data is referenced to package lead interface. Γ_S and Γ_L are the impedances presented to the DUT. All data is generated from load pull, not from the test circuit shown.

TYPICAL CHARACTERISTICS

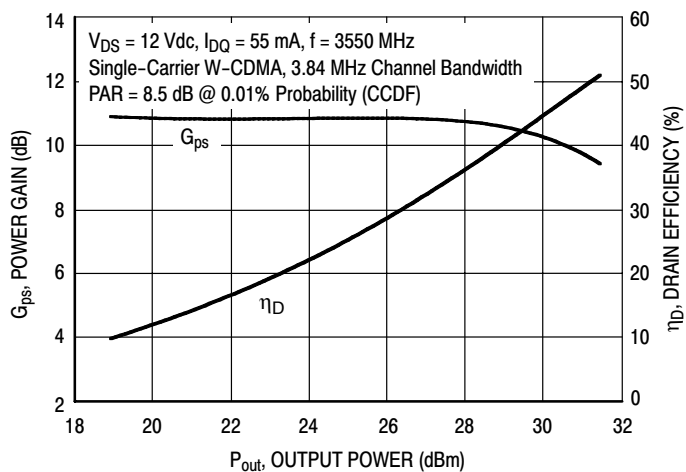

Figure 5. Single-Carrier W-CDMA Power Gain and Drain Efficiency versus Output Power

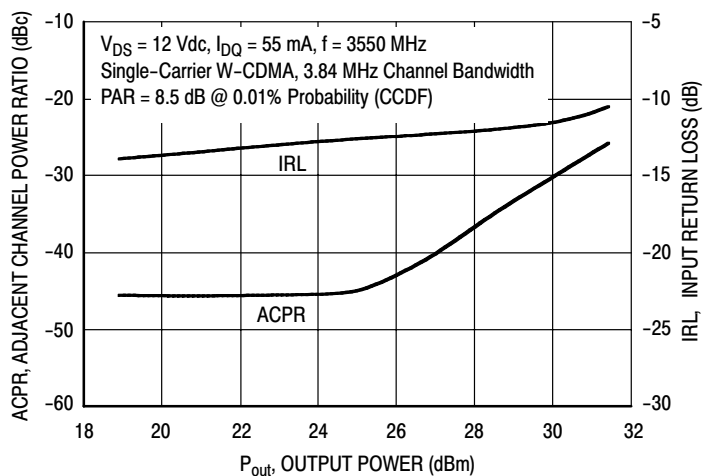

Figure 6. Single-Carrier W-CDMA ACPR and Input Return Loss versus Output Power

NOTE: Data is generated from the test circuit shown.

TYPICAL CHARACTERISTICS

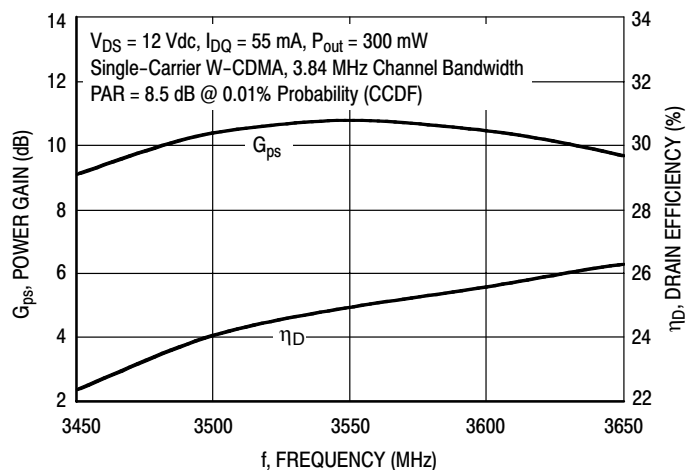

Figure 7. Single-Carrier W-CDMA Power Gain and Drain Efficiency versus Frequency

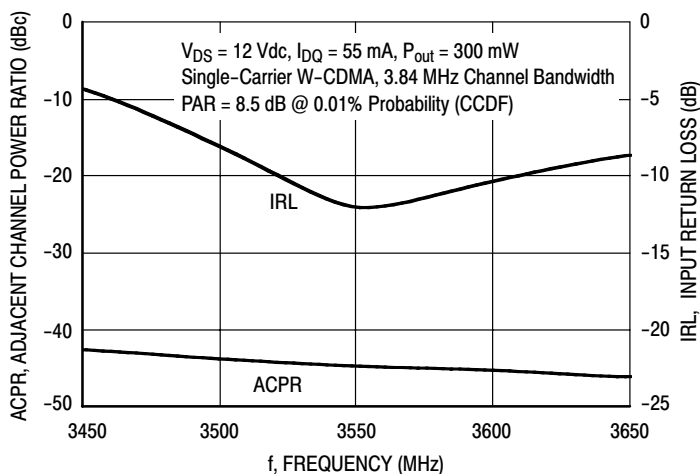

Figure 8. Single-Carrier W-CDMA ACPR and Input Return Loss versus Frequency

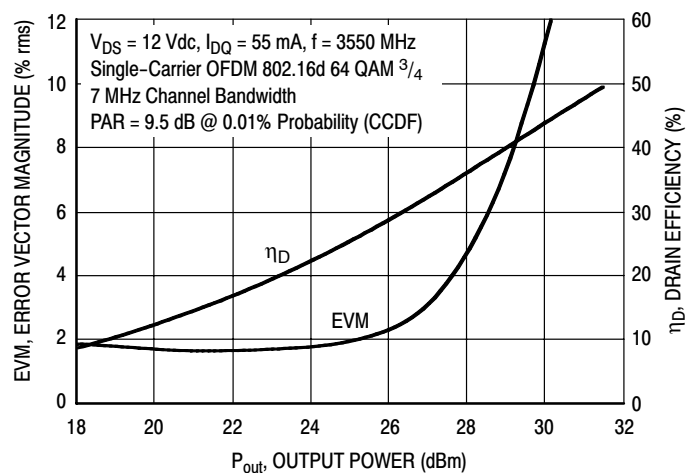
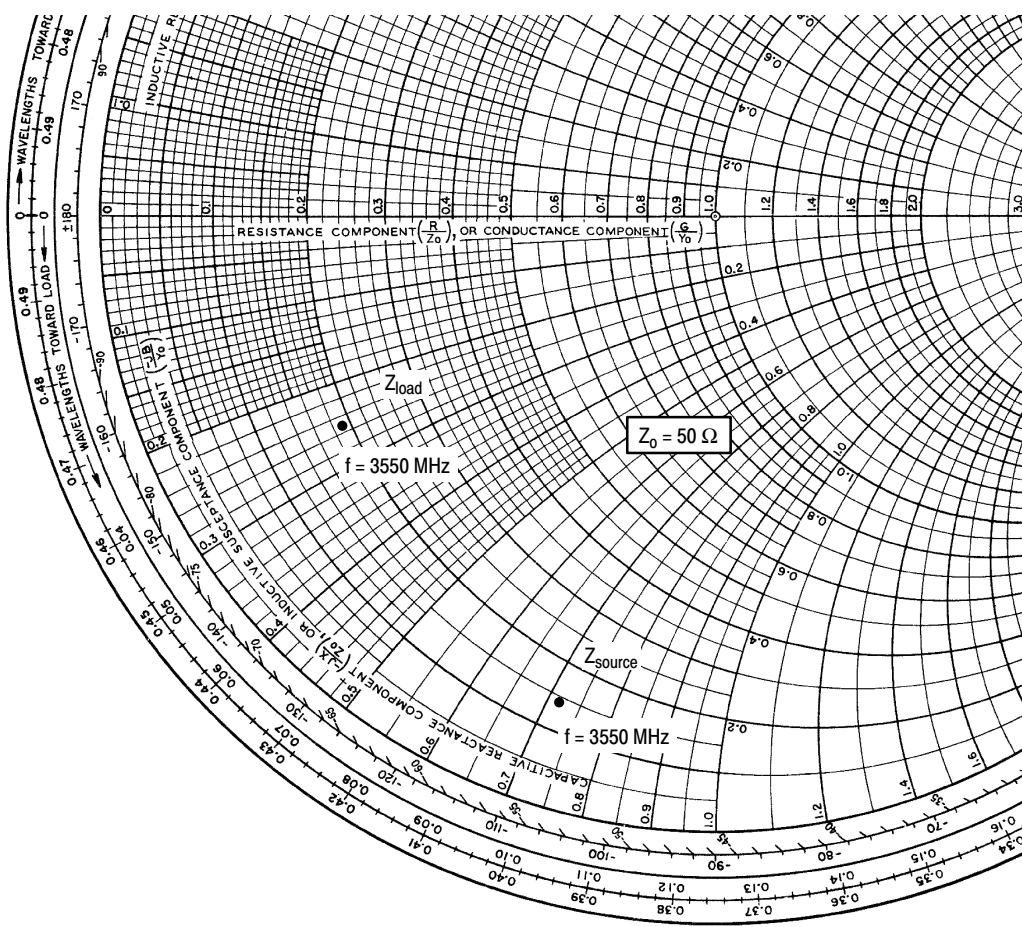

Figure 9. Single-Carrier OFDM EVM and Drain Efficiency versus Output Power

NOTE: Data is generated from the test circuit shown.



$V_{DD} = 12 \text{ Vdc}$, $I_{DQ} = 55 \text{ mA}$, $P_{out} = 300 \text{ mW Avg.}$

f MHz	Z_{source} Ω	Z_{load} Ω
3550	$6.9 - j35.8$	$9.5 - j12.4$

Z_{source} = Test circuit impedance as measured from gate to ground.

Z_{load} = Test circuit impedance as measured from drain to ground.

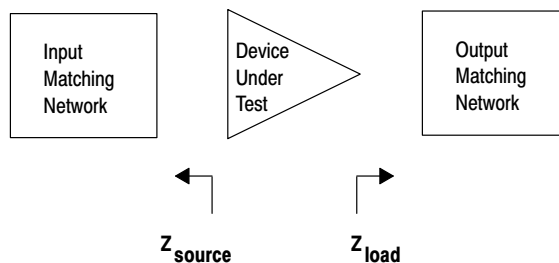

Figure 10. Series Equivalent Source and Load Impedance

Table 7. Class AB Common Source S-Parameters ($V_{DS} = 12 \text{ Vdc}$, $I_{DQ} = 55 \text{ mA}$, $T_A = 25^\circ\text{C}$, 50Ω system)

f GHz	S ₁₁		S ₂₁		S ₁₂		S ₂₂	
	S ₁₁	∠φ	S ₂₁	∠φ	S ₁₂	∠φ	S ₂₂	∠φ
0.500	0.893	-166.3	7.532	85.5	0.0369	3.0	0.553	-168.3
0.525	0.892	-167.7	7.180	84.3	0.0369	2.1	0.554	-169.3
0.550	0.894	-169.2	6.914	83.1	0.0370	1.3	0.554	-170.3
0.575	0.892	-170.3	6.550	81.9	0.0370	0.6	0.554	-171.1
0.600	0.893	-171.7	6.359	80.9	0.0371	-0.2	0.555	-171.9
0.625	0.893	-172.6	6.045	79.8	0.0371	-0.9	0.556	-172.7
0.650	0.893	-174.0	5.892	78.7	0.0372	-1.6	0.556	-173.4
0.675	0.893	-174.9	5.670	77.7	0.0372	-2.3	0.556	-174.1
0.700	0.893	-175.9	5.464	76.6	0.0372	-2.9	0.557	-174.7
0.725	0.894	-177.0	5.318	75.7	0.0372	-3.5	0.557	-175.4
0.750	0.893	-177.8	5.107	74.7	0.0372	-4.1	0.557	-176.0
0.775	0.894	-178.9	4.997	73.7	0.0373	-4.7	0.557	-176.6
0.800	0.893	-179.6	4.820	72.7	0.0373	-5.3	0.558	-177.1
0.825	0.893	179.4	4.697	71.8	0.0374	-5.9	0.558	-177.6
0.850	0.893	178.6	4.569	70.8	0.0374	-6.4	0.558	-178.1
0.875	0.893	177.8	4.420	69.9	0.0374	-7.0	0.559	-178.7
0.900	0.894	177.0	4.339	69.1	0.0375	-7.5	0.559	-179.2
0.925	0.893	176.4	4.184	68.1	0.0375	-8.1	0.559	-179.6
0.950	0.893	175.4	4.120	67.3	0.0375	-8.6	0.559	180.0
0.975	0.893	174.7	4.015	66.3	0.0376	-9.1	0.559	179.6
1.000	0.892	174.0	3.914	65.4	0.0376	-9.6	0.559	179.1
1.025	0.893	173.3	3.842	64.6	0.0376	-10.1	0.559	178.7
1.050	0.892	172.6	3.730	63.7	0.0377	-10.6	0.560	178.3
1.075	0.893	171.8	3.684	62.9	0.0377	-11.1	0.560	177.9
1.100	0.892	171.2	3.590	61.9	0.0378	-11.6	0.559	177.5
1.125	0.892	170.5	3.522	61.1	0.0378	-12.2	0.560	177.1
1.150	0.892	169.9	3.464	60.3	0.0379	-12.7	0.560	176.7
1.175	0.891	169.2	3.382	59.4	0.0379	-13.1	0.559	176.3
1.200	0.891	168.6	3.334	58.6	0.0380	-13.6	0.559	175.9
1.225	0.890	168.0	3.259	57.7	0.0380	-14.2	0.559	175.5
1.250	0.891	167.4	3.213	56.9	0.0380	-14.6	0.559	175.1
1.275	0.890	166.8	3.154	56.0	0.0381	-15.1	0.558	174.7
1.300	0.890	166.2	3.101	55.2	0.0382	-15.6	0.558	174.3
1.325	0.891	165.6	3.056	54.4	0.0382	-16.0	0.558	173.9
1.350	0.890	165.0	2.994	53.5	0.0383	-16.5	0.558	173.5
1.375	0.890	164.4	2.959	52.8	0.0383	-17.0	0.557	173.1
1.400	0.890	163.9	2.909	51.9	0.0384	-17.5	0.557	172.7
1.425	0.890	163.3	2.869	51.1	0.0384	-17.9	0.557	172.2
1.450	0.889	162.7	2.827	50.3	0.0385	-18.4	0.556	171.8
1.475	0.889	162.2	2.786	49.4	0.0385	-18.8	0.556	171.4
1.500	0.889	161.1	2.786	48.4	0.0391	-19.5	0.549	171.2
1.525	0.888	160.7	2.738	47.6	0.0391	-19.9	0.549	170.7
1.550	0.889	160.2	2.707	46.8	0.0391	-20.4	0.550	170.2
1.575	0.889	159.8	2.663	46.0	0.0391	-20.8	0.550	169.7

(continued)

Table 7. Class AB Common Source S-Parameters ($V_{DS} = 12\text{ Vdc}$, $I_{DQ} = 55\text{ mA}$, $T_A = 25^\circ\text{C}$, $50\ \Omega$ system) (continued)

f GHz	S ₁₁		S ₂₁		S ₁₂		S ₂₂	
	S ₁₁	∠φ	S ₂₁	∠φ	S ₁₂	∠φ	S ₂₂	∠φ
1.600	0.889	159.4	2.627	45.2	0.0391	-21.2	0.551	169.3
1.625	0.889	159.0	2.594	44.4	0.0392	-21.6	0.551	168.8
1.650	0.888	158.5	2.554	43.6	0.0392	-22.0	0.551	168.4
1.675	0.888	158.1	2.526	42.9	0.0392	-22.4	0.552	168.0
1.700	0.887	157.6	2.486	42.0	0.0392	-22.9	0.552	167.6
1.725	0.887	157.1	2.460	41.3	0.0392	-23.3	0.553	167.2
1.750	0.887	156.6	2.428	40.5	0.0393	-23.7	0.553	166.9
1.775	0.886	156.1	2.395	39.7	0.0393	-24.1	0.553	166.5
1.800	0.886	155.6	2.370	38.9	0.0393	-24.6	0.554	166.2
1.825	0.886	155.1	2.337	38.1	0.0394	-25.0	0.554	165.9
1.850	0.886	154.5	2.315	37.3	0.0394	-25.5	0.554	165.5
1.875	0.885	154.0	2.286	36.5	0.0394	-25.9	0.554	165.2
1.900	0.885	153.5	2.262	35.7	0.0395	-26.3	0.554	164.9
1.925	0.885	152.9	2.238	34.9	0.0395	-26.8	0.554	164.6
1.950	0.884	152.3	2.211	34.0	0.0396	-27.2	0.553	164.4
1.975	0.884	151.7	2.194	33.2	0.0396	-27.7	0.553	164.1
2.000	0.884	151.1	2.168	32.4	0.0397	-28.2	0.553	163.8
2.025	0.883	150.5	2.149	31.6	0.0398	-28.6	0.553	163.5
2.050	0.884	149.9	2.129	30.8	0.0399	-29.1	0.552	163.3
2.075	0.883	149.3	2.108	30.0	0.0400	-29.5	0.551	163.0
2.100	0.883	148.6	2.092	29.2	0.0401	-30.0	0.551	162.8
2.125	0.882	148.0	2.071	28.3	0.0402	-30.5	0.550	162.5
2.150	0.883	147.3	2.058	27.5	0.0402	-30.9	0.550	162.3
2.175	0.882	146.7	2.040	26.7	0.0404	-31.4	0.549	162.0
2.200	0.881	146.0	2.026	25.8	0.0405	-31.9	0.548	161.8
2.225	0.881	145.3	2.012	25.0	0.0406	-32.4	0.547	161.5
2.250	0.880	144.6	1.996	24.2	0.0408	-32.8	0.546	161.2
2.275	0.880	143.9	1.986	23.3	0.0409	-33.3	0.545	160.9
2.300	0.879	143.2	1.971	22.5	0.0411	-33.8	0.544	160.6
2.325	0.878	142.6	1.960	21.6	0.0412	-34.3	0.543	160.3
2.350	0.878	141.9	1.947	20.8	0.0414	-34.9	0.542	160.0
2.375	0.877	141.2	1.936	19.9	0.0416	-35.4	0.541	159.7
2.400	0.876	140.5	1.927	19.0	0.0417	-35.9	0.540	159.3
2.425	0.875	139.8	1.913	18.1	0.0419	-36.5	0.538	158.9
2.450	0.875	139.1	1.905	17.3	0.0421	-37.0	0.537	158.5
2.475	0.875	138.5	1.895	16.4	0.0422	-37.5	0.536	158.1
2.500	0.874	137.8	1.885	15.5	0.0424	-38.1	0.535	157.7
2.525	0.874	137.1	1.877	14.7	0.0425	-38.6	0.533	157.2
2.550	0.873	136.4	1.866	13.8	0.0427	-39.2	0.532	156.7
2.575	0.873	135.8	1.860	12.9	0.0429	-39.7	0.530	156.3
2.600	0.872	135.1	1.850	12.0	0.0431	-40.3	0.529	155.8
2.625	0.871	134.4	1.843	11.1	0.0432	-40.8	0.528	155.3
2.650	0.871	133.7	1.834	10.2	0.0434	-41.4	0.526	154.8
2.675	0.870	133.1	1.826	9.3	0.0436	-41.9	0.525	154.4

(continued)

Table 7. Class AB Common Source S-Parameters ($V_{DS} = 12 \text{ Vdc}$, $I_{DQ} = 55 \text{ mA}$, $T_A = 25^\circ\text{C}$, 50Ω system) (continued)

f GHz	S_{11}		S_{21}		S_{12}		S_{22}	
	$ S_{11} $	$\angle \phi$	$ S_{21} $	$\angle \phi$	$ S_{12} $	$\angle \phi$	$ S_{22} $	$\angle \phi$
2.700	0.870	132.4	1.821	8.4	0.0438	-42.4	0.524	153.9
2.725	0.868	131.7	1.811	7.5	0.0440	-43.0	0.522	153.4
2.750	0.868	130.9	1.806	6.6	0.0442	-43.6	0.521	153.0
2.775	0.867	130.2	1.797	5.7	0.0443	-44.1	0.520	152.5
2.800	0.866	129.5	1.791	4.7	0.0445	-44.7	0.519	152.0
2.825	0.865	128.7	1.786	3.8	0.0447	-45.3	0.517	151.6
2.850	0.864	128.0	1.777	2.9	0.0449	-45.8	0.516	151.1
2.875	0.863	127.2	1.774	2.0	0.0451	-46.4	0.514	150.6
2.900	0.862	126.4	1.765	1.0	0.0452	-47.0	0.513	150.2
2.925	0.861	125.6	1.761	0.1	0.0454	-47.6	0.511	149.7
2.950	0.860	124.8	1.755	-0.8	0.0456	-48.2	0.510	149.2
2.975	0.859	123.9	1.749	-1.8	0.0458	-48.7	0.508	148.7
3.000	0.859	123.1	1.746	-2.8	0.0460	-49.3	0.506	148.2
3.025	0.857	122.3	1.739	-3.8	0.0463	-49.9	0.504	147.7
3.050	0.857	121.4	1.737	-4.7	0.0465	-50.5	0.502	147.1
3.075	0.856	120.5	1.730	-5.7	0.0467	-51.1	0.500	146.6
3.100	0.855	119.6	1.727	-6.7	0.0469	-51.7	0.498	146.1
3.125	0.855	118.8	1.723	-7.7	0.0471	-52.4	0.496	145.5
3.150	0.854	117.9	1.717	-8.7	0.0474	-53.0	0.495	144.9
3.175	0.853	117.0	1.716	-9.7	0.0476	-53.6	0.493	144.4
3.200	0.853	116.1	1.710	-10.7	0.0479	-54.3	0.491	143.8
3.225	0.852	115.2	1.709	-11.7	0.0482	-54.9	0.490	143.1
3.250	0.851	114.3	1.705	-12.7	0.0484	-55.6	0.488	142.5
3.275	0.850	113.4	1.702	-13.7	0.0487	-56.3	0.486	141.9
3.300	0.850	112.5	1.700	-14.8	0.0489	-56.9	0.485	141.3
3.325	0.849	111.6	1.695	-15.8	0.0491	-57.6	0.483	140.6
3.350	0.848	110.7	1.695	-16.8	0.0494	-58.3	0.482	139.9
3.375	0.847	109.8	1.691	-17.8	0.0497	-59.0	0.481	139.3
3.400	0.846	108.9	1.689	-18.8	0.0499	-59.6	0.479	138.6
3.425	0.845	108.0	1.687	-19.9	0.0502	-60.3	0.478	137.9
3.450	0.843	107.1	1.683	-20.9	0.0505	-61.0	0.477	137.2
3.475	0.843	106.2	1.682	-21.9	0.0507	-61.7	0.476	136.5
3.500	0.842	105.3	1.678	-22.9	0.0509	-62.4	0.475	135.9
3.525	0.841	104.3	1.677	-24.0	0.0512	-63.0	0.474	135.2
3.550	0.840	103.4	1.674	-25.0	0.0514	-63.8	0.473	134.5
3.575	0.838	102.5	1.671	-26.0	0.0517	-64.4	0.472	133.8
3.600	0.838	101.6	1.670	-27.1	0.0519	-65.1	0.471	133.2
3.625	0.836	100.7	1.666	-28.1	0.0521	-65.8	0.470	132.5
3.650	0.836	99.8	1.665	-29.1	0.0524	-66.5	0.468	131.8
3.675	0.834	98.9	1.661	-30.2	0.0526	-67.2	0.467	131.2
3.700	0.833	98.0	1.660	-31.2	0.0528	-67.9	0.466	130.5
3.725	0.832	97.1	1.657	-32.2	0.0530	-68.6	0.465	129.9
3.750	0.831	96.2	1.654	-33.2	0.0532	-69.3	0.464	129.3
3.775	0.830	95.2	1.654	-34.3	0.0534	-69.9	0.463	128.7

(continued)

Table 7. Class AB Common Source S-Parameters ($V_{DS} = 12 \text{ Vdc}$, $I_{DQ} = 55 \text{ mA}$, $T_A = 25^\circ\text{C}$, 50Ω system) (continued)

f GHz	S_{11}		S_{21}		S_{12}		S_{22}	
	$ S_{11} $	$\angle \phi$	$ S_{21} $	$\angle \phi$	$ S_{12} $	$\angle \phi$	$ S_{22} $	$\angle \phi$
3.800	0.829	94.3	1.650	-35.3	0.0537	-70.6	0.461	128.2
3.825	0.828	93.3	1.649	-36.3	0.0539	-71.3	0.460	127.6
3.850	0.827	92.4	1.646	-37.4	0.0541	-72.0	0.459	127.1
3.875	0.825	91.4	1.645	-38.4	0.0543	-72.6	0.457	126.5
3.900	0.825	90.3	1.644	-39.5	0.0546	-73.3	0.456	126.0
3.925	0.823	89.3	1.641	-40.5	0.0548	-74.0	0.454	125.5
3.950	0.822	88.2	1.641	-41.6	0.0550	-74.7	0.452	124.9
3.975	0.821	87.1	1.638	-42.7	0.0553	-75.5	0.450	124.4
4.000	0.820	86.0	1.638	-43.8	0.0555	-76.2	0.448	123.9
4.025	0.819	84.8	1.636	-44.9	0.0558	-76.9	0.445	123.4
4.050	0.818	83.6	1.634	-46.0	0.0560	-77.7	0.443	122.8
4.075	0.817	82.4	1.634	-47.1	0.0562	-78.4	0.440	122.2
4.100	0.816	81.2	1.631	-48.3	0.0565	-79.2	0.437	121.7
4.125	0.815	80.0	1.631	-49.4	0.0568	-80.0	0.435	121.1
4.150	0.815	78.7	1.630	-50.6	0.0570	-80.8	0.432	120.5
4.175	0.814	77.4	1.628	-51.8	0.0572	-81.6	0.429	119.9
4.200	0.813	76.1	1.627	-52.9	0.0575	-82.4	0.426	119.2
4.225	0.812	74.7	1.626	-54.1	0.0578	-83.2	0.422	118.5
4.250	0.812	73.4	1.626	-55.4	0.0580	-84.1	0.419	117.8
4.275	0.810	72.0	1.623	-56.6	0.0583	-84.9	0.416	117.0
4.300	0.810	70.6	1.624	-57.8	0.0586	-85.8	0.413	116.2
4.325	0.810	69.2	1.623	-59.1	0.0588	-86.7	0.410	115.4
4.350	0.809	67.8	1.622	-60.3	0.0591	-87.6	0.406	114.6
4.375	0.809	66.4	1.622	-61.6	0.0594	-88.5	0.403	113.7
4.400	0.808	64.9	1.620	-62.9	0.0596	-89.5	0.400	112.9
4.425	0.808	63.4	1.620	-64.2	0.0598	-90.4	0.397	111.9
4.450	0.807	61.9	1.619	-65.5	0.0600	-91.4	0.393	111.0
4.475	0.807	60.4	1.618	-66.9	0.0603	-92.2	0.390	110.0
4.500	0.806	58.8	1.617	-68.2	0.0606	-93.2	0.386	109.0
4.525	0.806	57.3	1.615	-69.5	0.0608	-94.1	0.383	108.0
4.550	0.806	55.7	1.615	-70.9	0.0611	-95.1	0.379	106.9
4.575	0.805	54.2	1.612	-72.3	0.0614	-96.1	0.375	105.8
4.600	0.805	52.6	1.612	-73.6	0.0616	-97.1	0.372	104.6
4.625	0.805	51.0	1.609	-75.0	0.0619	-98.2	0.368	103.5
4.650	0.805	49.4	1.607	-76.4	0.0621	-99.2	0.365	102.2
4.675	0.805	47.8	1.605	-77.8	0.0623	-100.2	0.361	101.0
4.700	0.805	46.2	1.601	-79.2	0.0625	-101.3	0.357	99.7
4.725	0.805	44.6	1.601	-80.6	0.0627	-102.4	0.354	98.3
4.750	0.806	43.0	1.596	-82.0	0.0629	-103.4	0.349	97.0
4.775	0.806	41.3	1.594	-83.5	0.0631	-104.5	0.346	95.5
4.800	0.806	39.7	1.590	-84.9	0.0632	-105.5	0.342	94.0
4.825	0.806	38.1	1.586	-86.4	0.0634	-106.6	0.338	92.4
4.850	0.807	36.5	1.583	-87.8	0.0635	-107.7	0.334	90.8
4.875	0.807	34.8	1.578	-89.3	0.0637	-108.8	0.330	89.2

(continued)

Table 7. Class AB Common Source S-Parameters ($V_{DS} = 12 \text{ Vdc}$, $I_{DQ} = 55 \text{ mA}$, $T_A = 25^\circ\text{C}$, 50Ω system) (continued)

f GHz	S ₁₁		S ₂₁		S ₁₂		S ₂₂	
	S ₁₁	∠φ	S ₂₁	∠φ	S ₁₂	∠φ	S ₂₂	∠φ
4.900	0.808	33.2	1.574	-90.8	0.0638	-109.9	0.326	87.4
4.925	0.808	31.5	1.567	-92.2	0.0639	-111.1	0.322	85.6
4.950	0.809	29.8	1.564	-93.7	0.0640	-112.3	0.318	83.7
4.975	0.810	28.2	1.558	-95.2	0.0641	-113.5	0.315	81.7
5.000	0.811	26.5	1.550	-96.7	0.0639	-114.6	0.311	79.7
5.025	0.812	24.8	1.545	-98.2	0.0639	-115.8	0.308	77.6
5.050	0.813	23.1	1.537	-99.7	0.0639	-116.9	0.305	75.4
5.075	0.814	21.4	1.531	-101.2	0.0638	-118.0	0.302	73.2
5.100	0.814	19.7	1.523	-102.7	0.0637	-119.1	0.299	70.9
5.125	0.815	18.0	1.516	-104.2	0.0638	-120.2	0.297	68.6
5.150	0.817	16.3	1.508	-105.8	0.0637	-121.3	0.295	66.2
5.175	0.818	14.6	1.499	-107.3	0.0637	-122.5	0.293	63.8
5.200	0.819	12.9	1.492	-108.8	0.0637	-123.7	0.292	61.4
5.225	0.821	11.2	1.482	-110.4	0.0636	-124.8	0.291	58.9
5.250	0.822	9.5	1.474	-111.9	0.0634	-126.0	0.291	56.4
5.275	0.823	7.8	1.464	-113.5	0.0633	-127.1	0.291	53.9
5.300	0.825	6.1	1.454	-115.0	0.0632	-128.3	0.291	51.4
5.325	0.826	4.4	1.444	-116.5	0.0631	-129.5	0.292	49.0
5.350	0.828	2.7	1.433	-118.1	0.0630	-130.6	0.293	46.5
5.375	0.829	1.0	1.424	-119.6	0.0628	-131.8	0.294	44.1
5.400	0.831	-0.7	1.413	-121.2	0.0627	-133.0	0.296	41.7
5.425	0.832	-2.4	1.403	-122.7	0.0625	-134.2	0.297	39.4
5.450	0.834	-4.1	1.392	-124.3	0.0624	-135.4	0.300	37.0
5.475	0.835	-5.7	1.381	-125.8	0.0622	-136.6	0.302	34.7
5.500	0.836	-7.4	1.370	-127.4	0.0620	-137.8	0.304	32.5
5.525	0.838	-9.1	1.359	-128.9	0.0618	-139.0	0.306	30.3
5.550	0.840	-10.7	1.349	-130.5	0.0616	-140.2	0.309	28.1
5.575	0.841	-12.3	1.337	-132.0	0.0614	-141.3	0.311	26.0
5.600	0.842	-14.0	1.326	-133.5	0.0613	-142.5	0.314	23.9
5.625	0.844	-15.6	1.316	-135.1	0.0611	-143.7	0.316	21.9
5.650	0.845	-17.2	1.304	-136.6	0.0609	-144.9	0.319	19.9
5.675	0.847	-18.8	1.294	-138.1	0.0607	-146.1	0.321	17.9
5.700	0.848	-20.4	1.283	-139.7	0.0604	-147.3	0.324	15.9
5.725	0.849	-22.0	1.272	-141.2	0.0602	-148.4	0.326	13.9
5.750	0.851	-23.5	1.261	-142.7	0.0601	-149.6	0.329	12.0
5.775	0.852	-25.1	1.251	-144.2	0.0599	-150.8	0.331	10.0
5.800	0.853	-26.6	1.240	-145.7	0.0596	-151.9	0.334	8.1
5.825	0.855	-28.2	1.230	-147.2	0.0594	-153.1	0.336	6.2
5.850	0.857	-29.7	1.220	-148.8	0.0592	-154.1	0.338	4.2
5.875	0.858	-31.3	1.209	-150.3	0.0591	-155.3	0.341	2.2
5.900	0.859	-32.7	1.199	-151.8	0.0589	-156.4	0.343	0.2
5.925	0.860	-34.3	1.188	-153.3	0.0587	-157.5	0.346	-1.7
5.950	0.862	-35.8	1.178	-154.8	0.0586	-158.6	0.348	-3.7
5.975	0.863	-37.3	1.168	-156.3	0.0585	-159.7	0.351	-5.7

(continued)

Table 7. Class AB Common Source S-Parameters ($V_{DS} = 12 \text{ Vdc}$, $I_{DQ} = 55 \text{ mA}$, $T_A = 25^\circ\text{C}$, 50Ω system) (continued)

f GHz	S_{11}		S_{21}		S_{12}		S_{22}	
	$ S_{11} $	$\angle \phi$	$ S_{21} $	$\angle \phi$	$ S_{12} $	$\angle \phi$	$ S_{22} $	$\angle \phi$
6.000	0.865	-38.7	1.157	-157.8	0.0584	-160.9	0.353	-7.8
6.025	0.866	-40.2	1.147	-159.3	0.0582	-162.1	0.356	-9.8
6.050	0.868	-41.7	1.136	-160.8	0.0580	-163.3	0.360	-11.8
6.075	0.869	-43.1	1.126	-162.3	0.0577	-164.3	0.363	-13.9
6.100	0.871	-44.6	1.115	-163.8	0.0576	-165.4	0.367	-15.9
6.125	0.872	-46.1	1.103	-165.3	0.0574	-166.4	0.370	-17.9
6.150	0.874	-47.5	1.093	-166.8	0.0574	-167.4	0.375	-19.9
6.175	0.875	-49.0	1.081	-168.3	0.0573	-168.5	0.379	-21.8
6.200	0.876	-50.4	1.070	-169.8	0.0572	-169.6	0.383	-23.7
6.225	0.877	-51.9	1.059	-171.3	0.0571	-170.7	0.388	-25.6
6.250	0.879	-53.3	1.047	-172.8	0.0570	-171.9	0.393	-27.5
6.275	0.880	-54.7	1.036	-174.3	0.0568	-173.0	0.398	-29.3
6.300	0.881	-56.1	1.024	-175.8	0.0567	-174.0	0.403	-31.1
6.325	0.883	-57.6	1.013	-177.3	0.0566	-175.0	0.407	-32.9
6.350	0.884	-59.0	1.001	-178.8	0.0565	-176.0	0.412	-34.6
6.375	0.886	-60.4	0.989	-179.7	0.0566	-176.9	0.417	-36.4
6.400	0.887	-61.8	0.978	-178.3	0.0567	-177.9	0.422	-38.1
6.425	0.888	-63.2	0.966	-176.8	0.0569	-178.9	0.427	-39.8
6.450	0.890	-64.6	0.954	-175.3	0.0571	-180.0	0.432	-41.5
6.475	0.891	-66.0	0.942	-173.8	0.0573	-178.9	0.437	-43.2
6.500	0.892	-67.4	0.930	-172.3	0.0577	-177.8	0.443	-44.9
6.525	0.893	-68.7	0.918	-170.9	0.0580	-176.6	0.448	-46.6
6.550	0.894	-70.2	0.906	-169.4	0.0584	-175.3	0.453	-48.3
6.575	0.896	-71.5	0.894	-167.9	0.0588	-174.0	0.459	-50.0
6.600	0.897	-72.8	0.882	-166.5	0.0592	-172.8	0.465	-51.7
6.625	0.898	-74.2	0.870	-165.0	0.0599	-171.5	0.471	-53.3
6.650	0.898	-75.6	0.858	-163.6	0.0608	-170.2	0.478	-55.0
6.675	0.900	-76.9	0.847	-162.2	0.0618	-168.5	0.484	-56.6
6.700	0.901	-78.2	0.835	-160.8	0.0629	-166.5	0.490	-58.2
6.725	0.900	-79.5	0.824	-159.3	0.0638	-164.2	0.496	-59.8
6.750	0.901	-80.8	0.812	-157.9	0.0645	-161.8	0.503	-61.3
6.775	0.902	-82.1	0.801	-156.5	0.0652	-159.4	0.509	-62.8
6.800	0.903	-83.3	0.790	-155.1	0.0657	-156.8	0.515	-64.3
6.825	0.903	-84.5	0.779	-153.8	0.0665	-154.2	0.522	-65.7
6.850	0.903	-85.7	0.768	-152.4	0.0671	-151.1	0.528	-67.1
6.875	0.903	-86.9	0.757	-151.0	0.0676	-147.8	0.533	-68.4
6.900	0.904	-88.0	0.747	-149.6	0.0674	-144.2	0.539	-69.7
6.925	0.904	-89.1	0.736	-148.3	0.0670	-140.7	0.545	-70.9
6.950	0.904	-90.0	0.725	-146.9	0.0663	-136.8	0.551	-72.0
6.975	0.906	-91.1	0.715	-145.6	0.0649	-132.7	0.556	-73.0
7.000	0.907	-92.0	0.704	-144.3	0.0624	-129.1	0.562	-73.9
7.025	0.908	-93.0	0.693	-143.0	0.0599	-126.2	0.569	-74.9
7.050	0.910	-93.9	0.682	-141.7	0.0574	-123.6	0.576	-75.7
7.075	0.911	-94.8	0.671	-140.5	0.0550	-121.6	0.583	-76.6

(continued)

Table 7. Class AB Common Source S-Parameters ($V_{DS} = 12 \text{ Vdc}$, $I_{DQ} = 55 \text{ mA}$, $T_A = 25^\circ\text{C}$, 50Ω system) (continued)

f GHz	S ₁₁		S ₂₁		S ₁₂		S ₂₂	
	S ₁₁	∠φ	S ₂₁	∠φ	S ₁₂	∠φ	S ₂₂	∠φ
7.100	0.914	-95.7	0.660	139.3	0.0529	120.1	0.590	-77.4
7.125	0.914	-96.5	0.650	138.2	0.0514	118.4	0.598	-78.2
7.150	0.916	-97.4	0.640	137.0	0.0498	116.5	0.605	-79.0
7.175	0.917	-98.1	0.629	135.9	0.0479	114.7	0.612	-79.7
7.200	0.920	-98.9	0.619	134.8	0.0459	113.4	0.619	-80.4
7.225	0.922	-99.7	0.609	133.8	0.0444	112.3	0.626	-81.0
7.250	0.923	-100.4	0.599	132.8	0.0429	111.2	0.634	-81.7
7.275	0.925	-101.1	0.590	131.7	0.0415	110.3	0.640	-82.3
7.300	0.926	-101.8	0.580	130.8	0.0402	109.4	0.646	-82.9
7.325	0.928	-102.4	0.570	129.8	0.0389	108.7	0.653	-83.5
7.350	0.929	-103.0	0.561	128.9	0.0380	107.9	0.659	-84.1
7.375	0.930	-103.6	0.552	128.0	0.0369	107.1	0.664	-84.6
7.400	0.933	-104.2	0.543	127.0	0.0358	106.3	0.670	-85.2
7.425	0.934	-104.7	0.534	126.2	0.0348	105.8	0.675	-85.7
7.450	0.934	-105.2	0.525	125.2	0.0340	105.1	0.679	-86.3
7.475	0.935	-105.8	0.516	124.3	0.0332	104.4	0.684	-86.8
7.500	0.937	-106.4	0.508	123.5	0.0324	103.9	0.689	-87.3
7.525	0.938	-106.8	0.500	122.6	0.0316	102.8	0.692	-87.8
7.550	0.938	-107.3	0.491	121.7	0.0308	102.3	0.696	-88.5
7.575	0.939	-107.9	0.483	120.8	0.0300	101.3	0.700	-89.0
7.600	0.939	-108.4	0.475	119.9	0.0292	100.7	0.704	-89.6
7.625	0.940	-108.9	0.468	119.1	0.0285	100.3	0.707	-90.2
7.650	0.940	-109.3	0.460	118.2	0.0278	99.6	0.711	-90.9
7.675	0.940	-109.8	0.452	117.3	0.0271	98.9	0.714	-91.6
7.700	0.942	-110.3	0.445	116.4	0.0264	98.5	0.717	-92.2
7.725	0.942	-110.8	0.438	115.6	0.0258	97.9	0.721	-93.0
7.750	0.943	-111.2	0.431	114.7	0.0251	97.4	0.724	-93.7
7.775	0.943	-111.7	0.423	113.8	0.0245	96.9	0.727	-94.4
7.800	0.944	-112.3	0.416	113.0	0.0240	96.3	0.730	-95.2
7.825	0.945	-112.8	0.409	112.1	0.0233	95.8	0.733	-95.9
7.850	0.946	-113.2	0.403	111.2	0.0228	95.5	0.736	-96.7
7.875	0.946	-113.7	0.396	110.4	0.0223	95.1	0.740	-97.5
7.900	0.947	-114.2	0.389	109.5	0.0217	94.6	0.743	-98.3
7.925	0.949	-114.8	0.383	108.6	0.0212	94.3	0.746	-99.0
7.950	0.949	-115.3	0.377	107.7	0.0208	93.9	0.749	-99.8
7.975	0.949	-115.7	0.371	106.9	0.0203	93.6	0.752	-100.5
8.000	0.950	-116.2	0.365	106.0	0.0199	93.2	0.755	-101.3

PACKAGE DIMENSIONS

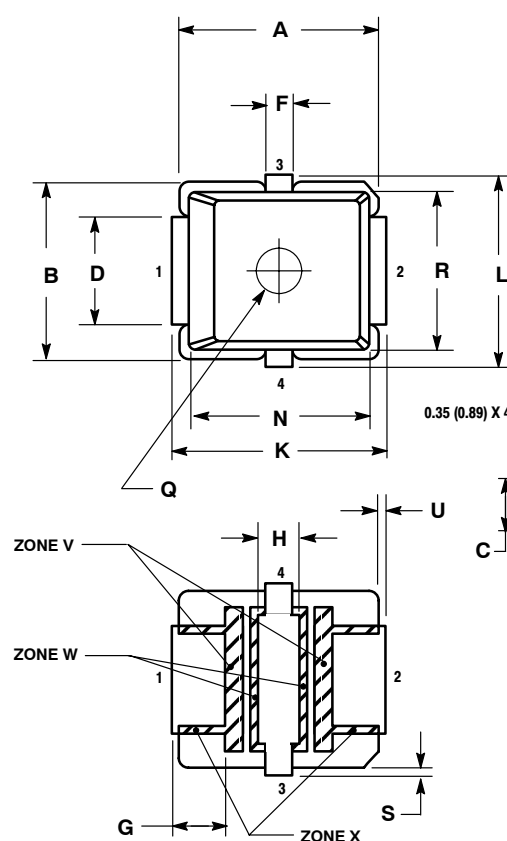

VIEW Y-Y

**CASE 466-03
ISSUE D
PLD-1.5
PLASTIC**

- NOTES:
1. INTERPRET DIMENSIONS AND TOLERANCES PER ASME Y14.5M, 1984.
 2. CONTROLLING DIMENSION: INCH
 3. RESIN BLEED/FLASH ALLOWABLE IN ZONE V, W, AND X.
- STYLE 1:
PIN 1. DRAIN
2. GATE
3. SOURCE
4. SOURCE

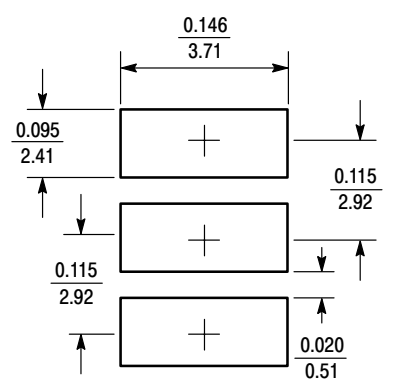

(inches)
mm

SOLDER FOOTPRINT

DIM	INCHES		MILLIMETERS	
	MIN	MAX	MIN	MAX
A	0.255	0.265	6.48	6.73
B	0.225	0.235	5.72	5.97
C	0.065	0.072	1.65	1.83
D	0.130	0.150	3.30	3.81
E	0.021	0.026	0.53	0.66
F	0.026	0.044	0.66	1.12
G	0.050	0.070	1.27	1.78
H	0.045	0.063	1.14	1.60
J	0.160	0.180	4.06	4.57
K	0.273	0.285	6.93	7.24
L	0.245	0.255	6.22	6.48
N	0.230	0.240	5.84	6.10
P	0.000	0.008	0.00	0.20
Q	0.055	0.063	1.40	1.60
R	0.200	0.210	5.08	5.33
S	0.006	0.012	0.15	0.31
U	0.006	0.012	0.15	0.31
ZONE V	0.000	0.021	0.00	0.53
ZONE W	0.000	0.010	0.00	0.25
ZONE X	0.000	0.010	0.00	0.25

PRODUCT DOCUMENTATION

Refer to the following documents to aid your design process.

Application Notes

- AN1955: Thermal Measurement Methodology of RF Power Amplifiers

REVISION HISTORY

The following table summarizes revisions to this document.

Revision	Date	Description
0	April 2007	<ul style="list-style-type: none"> • Initial Release of Data Sheet
1	Dec. 2008	<ul style="list-style-type: none"> • Removed "Operating Case Temperature Range" from Maximum Ratings table so that the maximum channel temperature rating is the limiting thermal design criteria and not the case temperature range, p. 1
2	June 2009	<ul style="list-style-type: none"> • Modified data sheet to reflect MSL rating change from 1 to 3 as a result of the standardization of packing process as described in Product and Process Change Notification number, PCN13516, p. 2

How to Reach Us:

Home Page:

www.freescale.com

Web Support:

<http://www.freescale.com/support>

USA/Europe or Locations Not Listed:

Freescale Semiconductor, Inc.
Technical Information Center, EL516
2100 East Elliot Road
Tempe, Arizona 85284
1-800-521-6274 or +1-480-768-2130
www.freescale.com/support

Europe, Middle East, and Africa:

Freescale Halbleiter Deutschland GmbH
Technical Information Center
Schatzbogen 7
81829 Muenchen, Germany
+44 1296 380 456 (English)
+46 8 52200080 (English)
+49 89 92103 559 (German)
+33 1 69 35 48 48 (French)
www.freescale.com/support

Japan:

Freescale Semiconductor Japan Ltd.
Headquarters
ARCO Tower 15F
1-8-1, Shimo-Meguro, Meguro-ku,
Tokyo 153-0064
Japan
0120 191014 or +81 3 5437 9125
support.japan@freescale.com

Asia/Pacific:

Freescale Semiconductor China Ltd.
Exchange Building 23F
No. 118 Jianguo Road
Chaoyang District
Beijing 100022
China
+86 10 5879 8000
support.asia@freescale.com

For Literature Requests Only:

Freescale Semiconductor Literature Distribution Center
1-800-441-2447 or +1-303-675-2140
Fax: +1-303-675-2150
LDCForFreescaleSemiconductor@hibbertgroup.com

Information in this document is provided solely to enable system and software implementers to use Freescale Semiconductor products. There are no express or implied copyright licenses granted hereunder to design or fabricate any integrated circuits or integrated circuits based on the information in this document.

Freescale Semiconductor reserves the right to make changes without further notice to any products herein. Freescale Semiconductor makes no warranty, representation or guarantee regarding the suitability of its products for any particular purpose, nor does Freescale Semiconductor assume any liability arising out of the application or use of any product or circuit, and specifically disclaims any and all liability, including without limitation consequential or incidental damages. "Typical" parameters that may be provided in Freescale Semiconductor data sheets and/or specifications can and do vary in different applications and actual performance may vary over time. All operating parameters, including "Typicals", must be validated for each customer application by customer's technical experts. Freescale Semiconductor does not convey any license under its patent rights nor the rights of others. Freescale Semiconductor products are not designed, intended, or authorized for use as components in systems intended for surgical implant into the body, or other applications intended to support or sustain life, or for any other application in which the failure of the Freescale Semiconductor product could create a situation where personal injury or death may occur. Should Buyer purchase or use Freescale Semiconductor products for any such unintended or unauthorized application, Buyer shall indemnify and hold Freescale Semiconductor and its officers, employees, subsidiaries, affiliates, and distributors harmless against all claims, costs, damages, and expenses, and reasonable attorney fees arising out of, directly or indirectly, any claim of personal injury or death associated with such unintended or unauthorized use, even if such claim alleges that Freescale Semiconductor was negligent regarding the design or manufacture of the part.

Freescale™ and the Freescale logo are trademarks of Freescale Semiconductor, Inc. All other product or service names are the property of their respective owners.

© Freescale Semiconductor, Inc. 2007-2009. All rights reserved.