

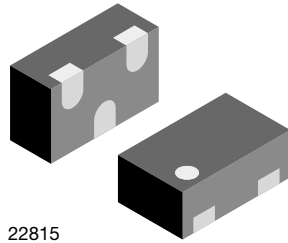

# 2-Line Low Capacitance, Bidirectional and Symmetrical (BiSy) ESD Protection Diode - Flow Through Design

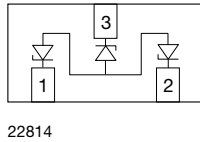

### FEATURES

- Compact LLP1006-3L package
- Low package height < 0.4 mm
- 2-line ESD protection
- Low leakage current  $I_R < 0.1 \mu A$
- Low capacitance:  $C_D < 0.4 pF$
- Ideal for high speed data line like
  - HDMI, DisplayPort, eSATA
  - USB, 1394 / firewire
  - Thunderbolt
- ESD immunity acc. IEC 61000-4-2
  - $\pm 20 kV$  contact discharge
  - $\pm 20 kV$  air discharge
- Soldering can be checked by standard vision inspection, no X-ray necessary
- Pin plating NiPdAu (e4) no whisker growth
- e4 - precious metal (e.g. Ag, Au, NiPd, NiPdAu) (no Sn)
- PATENT(S): [www.vishay.com/patents](http://www.vishay.com/patents)
- Material categorization: for definitions of compliance please see [www.vishay.com/doc?99912](http://www.vishay.com/doc?99912)



### MARKING (example only)



Bar = cathode marking  
 X = date code  
 Y = type code (see table below)

### DESIGN SUPPORT TOOLS click logo to get started



ORDERING INFORMATION			
DEVICE NAME	ORDERING CODE	TAPED UNITS PER REEL (8 mm TAPE ON 7" REEL)	MINIMUM ORDER QUANTITY
VBUS05M2-HT1	VBUS05M2-HT1-G4-08	8000	8000

PACKAGE DATA						
DEVICE NAME	PACKAGE NAME	TYPE CODE	WEIGHT	MOLDING COMPOUND FLAMMABILITY RATING	MOISTURE SENSITIVITY LEVEL	SOLDERING CONDITIONS
VBUS05M2-HT1	LLP1006-3L	5	0.72 mg	UL 94 V-0	MSL level 1 (according J-STD-020)	260 °C/10 s at terminals

ABSOLUTE MAXIMUM RATINGS				
PARAMETER	TEST CONDITIONS	SYMBOL	VALUE	UNIT
Peak pulse current	Acc. IEC 61000-4-5; $t_P = 8/20 \mu s$ ; single shot	$I_{PPM}$	3.6	A
Peak pulse power	Acc. IEC 61000-4-5; $t_P = 8/20 \mu s$ ; single shot	$P_{PP}$	65	W
ESD immunity	Contact discharge acc. IEC 61000-4-2; 10 pulses	$V_{ESD}$	$\pm 20$	kV
	Air discharge acc. IEC 61000-4-2; 10 pulses		$\pm 20$	
Operating temperature	Junction temperature	$T_J$	-55 to +125	°C
Storage temperature		$T_{STG}$	-55 to +150	°C

PATENT(S): [www.vishay.com/patents](http://www.vishay.com/patents)

This Vishay product is protected by one or more United States and international patents.

<b>ELECTRICAL CHARACTERISTICS</b> (pin 1 or pin 2 to pin 3; in both directions) ( $T_{amb} = 25\text{ }^{\circ}\text{C}$ , unless otherwise specified)						
PARAMETER	TEST CONDITIONS/REMARKS	SYMBOL	MIN.	TYP.	MAX.	UNIT
Protection paths	Number of lines which can be protected	$N_{channel}$	-	-	2	lines
Reverse stand-off voltage	Max. reverse working voltage	$V_{RWM}$	-	-	5.5	V
Reverse voltage	At $I_R = 0.1\text{ }\mu\text{A}$	$V_R$	5.5	-	-	V
Reverse current	At $V_{RWM} = 5.5\text{ V}$	$I_R$	-	< 0.001	0.1	$\mu\text{A}$
Reverse breakdown voltage	At $I_R = 1\text{ mA}$	$V_{BR}$	7.5	8.5	9.5	V
Reverse clamping voltage	At $I_{PP} = 1\text{ A}$	$V_C$	-	11	13	V
	At $I_{PP} = I_{PPM} = 3.6\text{ A}$	$V_C$	-	15	18	V
Clamping voltage	Transmission line pulse (TLP), $t_p = 100\text{ ns}$ $I_{TLP} = 8\text{ A}$	$V_{C-TLP}$	-	19	-	V
	Transmission line pulse (TLP), $t_p = 100\text{ ns}$ $I_{TLP} = 16\text{ A}$	$V_{C-TLP}$	-	27	-	V
Dynamic resistance	Transmission line pulse (TLP), $t_p = 100\text{ ns}$	$R_{DYN}$	-	1	-	$\Omega$
Capacitance	At $V_R = 0\text{ V}$ ; $f = 1\text{ MHz}$	$C_D$	-	0.35	0.4	pF
	At $V_R = 3.3\text{ V}$ ; $f = 1\text{ MHz}$		-	0.35	0.4	pF

### APPLICATION NOTE

The VBUS05M2-HT1 is a two-line ESD protection device with a bidirectional and symmetrical (BiSy) breakdown and clamping performance made for application with a voltage working range up to  $\pm 5.5\text{ V}$ . The high ESD immunity and a very low capacitance makes it usable for high frequency applications like USB2.0, USB3.0, or HDMI.

With the VBUS05M2-HT1 two high speed data lines can be protected against transient voltage signals like ESD (electro static discharge). Connected to the data line (pin 1 and pin 2) and to ground (pin 3) negative transients will be clamped close above the 5.5 V working range.

### FLOW THROUGH DESIGN

Modern digital transmission lines can be clocked up to 480 Mbit/s (USB2.0) or 1.65 Gbit/s (HDMI).

At such high data rates the transmission lines like cables or the line traces on the PCBs have to be very homogeneous regarding their surge impedance. This requires well defined trace dimensions as trace width and distance which have to be calculated depending on the requested surge impedance (e.g. 50  $\Omega$ ) and the PCB material and layer dimensions. Any device connected to the data lines - like ESD protection devices - have to be connected with minimal changes in these trace dimensions and distances.

With the package in the so called "Flow Through Design" this is possible. The lines are running straight along the PCB while the **VBUS05M2-HT1** is placed on top without any via or loops.

### SCHEMATIC DIAGRAM

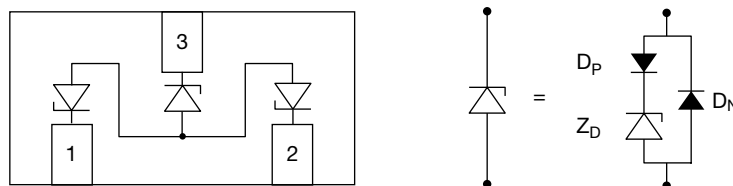

Fig. A

The simplified schematic diagram in Fig. A shows three identical Z-diodes with the cathode on pin 1, 2, or 3 and common anodes. In reality each Z-diode consist of one Z-diode for the adjustment of the breakdown voltage, and two low capacitance switching diodes which provide the low capacitance. Positive transients will be clamped through the switching diode  $D_P$  and the Z-diode  $Z_D$  while negative transients will be clamped through the switching diode  $D_N$ .

**TYPICAL CHARACTERISTICS** ( $T_{amb} = 25\text{ }^{\circ}\text{C}$ , unless otherwise specified)

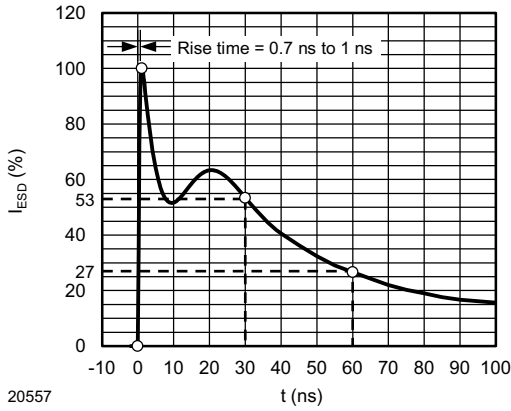

Fig. 1 - ESD Discharge Current Wave Form acc. IEC 61000-4-2 (330  $\Omega$ /150 pF)

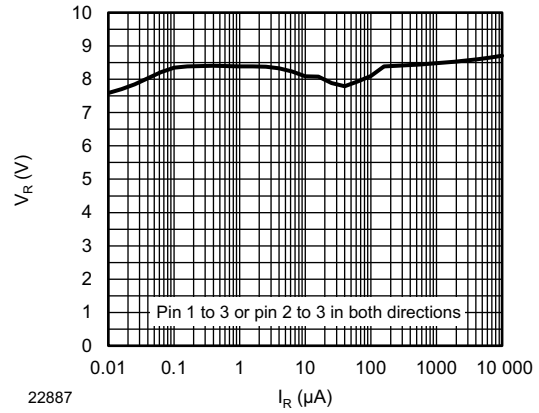

Fig. 4 - Typical Reverse Voltage vs. Reverse Current

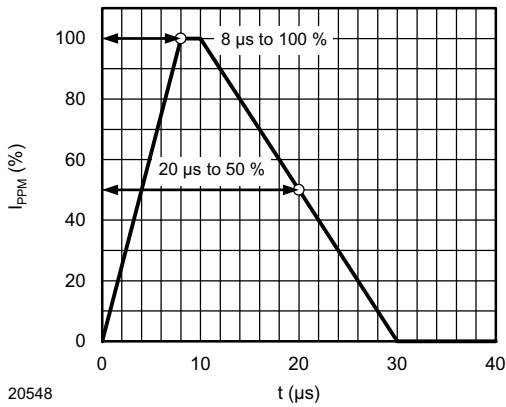

Fig. 2 - 8/20  $\mu\text{s}$  Peak Pulse Current Wave Form acc. IEC 61000-4-5

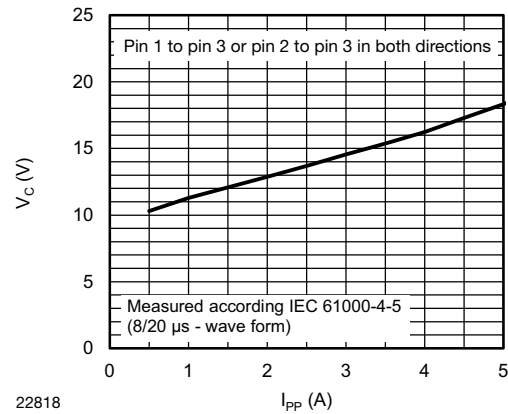

Fig. 5 - Typical Peak Clamping Voltage vs. Peak Pulse Current

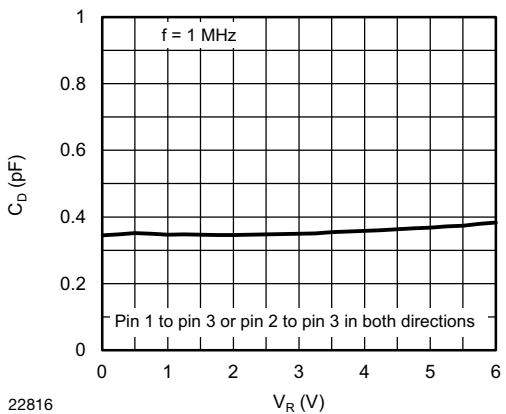

Fig. 3 - Typical Capacitance vs. Reverse Voltage

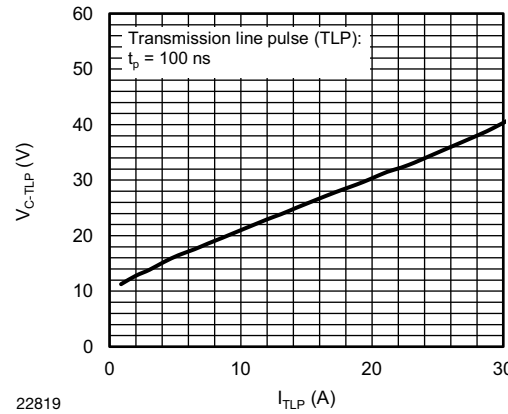
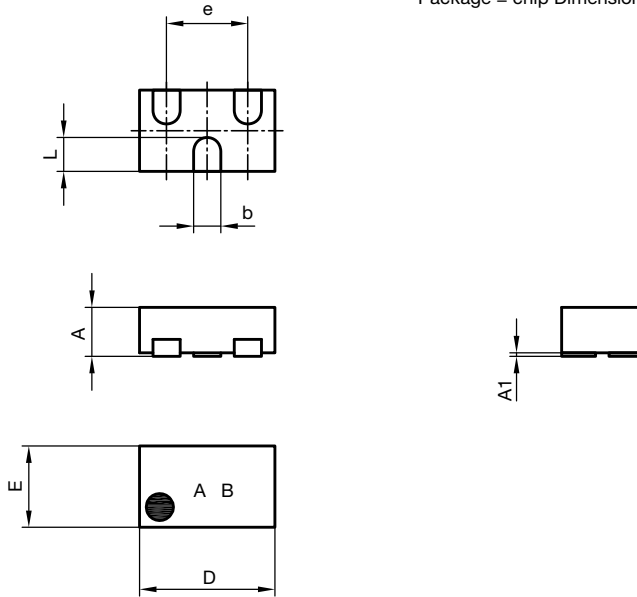

Fig. 6 - Typical Peak Forward Voltage vs. Forward Current



PACKAGE DIMENSIONS in millimeters: **LLP1006-3L**

Package = chip Dimensions in mm



	Millimeters	
	Min.	Max.
D	0.95	1.05
E	0.55	0.65
A	0.33	0.40
A1	0	0.05
b	0.2	
L	0.20	0.30
e	0.6	

Foot print recommendation:

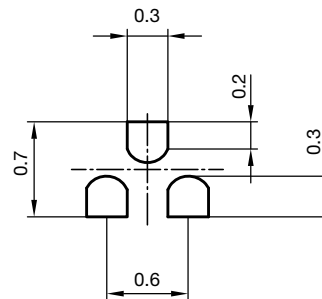

Document no.:S8-V-3906.04-044 (4)  
Created - Date: 03. Sep. 2015  
22820

**CARRIER TAPE** in millimeters: **LLP1006**

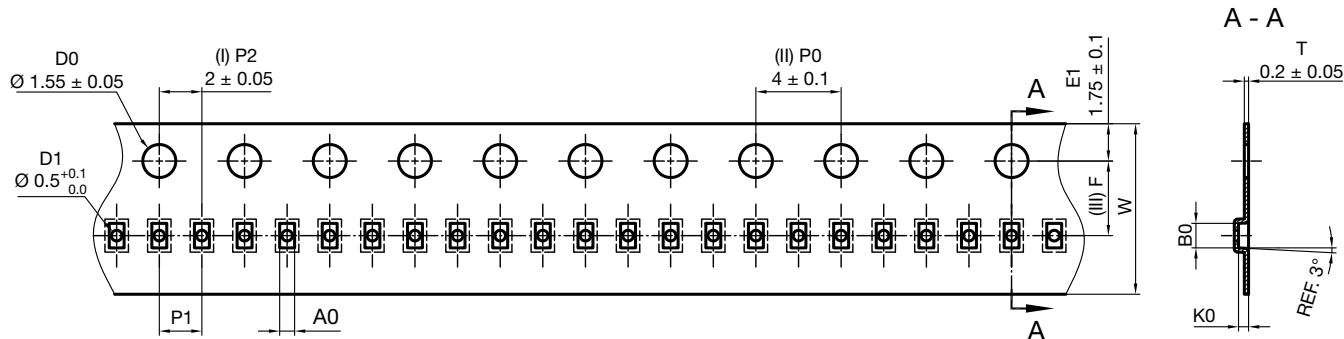

**Notes**

- (I) Measured from centreline of sprocket hole to centreline of pocket
- (II) Cumulative tolerance of 10 sprocket hole is  $\pm 0.20$
- (III) Measured from centreline of sprocket hole to centreline of pocket
- (IV) Other material available

	Millimeters
A0	$0.70 \pm 0.05$
B0	$1.15 \pm 0.05$
K0	$0.47 \pm 0.05$
F	$3.50 \pm 0.05$
P1	$2.00 \pm 0.1$
W	$8.00 \pm 0.1$

Doc. no. S8-V-3906.04-016 (3)  
 Created - Date: 12-Sep-2007  
 22823

**ORIENTATION IN CARRIER TAPE: LLP1006-3L**

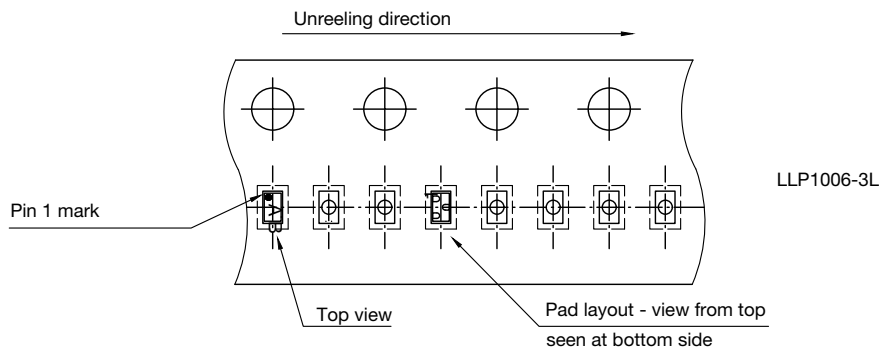

Doc. no. S8-V-3906.04-017 (4)  
 Created - Date: 02-May-2017  
 22821



## **Disclaimer**

ALL PRODUCT, PRODUCT SPECIFICATIONS AND DATA ARE SUBJECT TO CHANGE WITHOUT NOTICE TO IMPROVE RELIABILITY, FUNCTION OR DESIGN OR OTHERWISE.

Vishay Intertechnology, Inc., its affiliates, agents, and employees, and all persons acting on its or their behalf (collectively, "Vishay"), disclaim any and all liability for any errors, inaccuracies or incompleteness contained in any datasheet or in any other disclosure relating to any product.

Vishay makes no warranty, representation or guarantee regarding the suitability of the products for any particular purpose or the continuing production of any product. To the maximum extent permitted by applicable law, Vishay disclaims (i) any and all liability arising out of the application or use of any product, (ii) any and all liability, including without limitation special, consequential or incidental damages, and (iii) any and all implied warranties, including warranties of fitness for particular purpose, non-infringement and merchantability.

Statements regarding the suitability of products for certain types of applications are based on Vishay's knowledge of typical requirements that are often placed on Vishay products in generic applications. Such statements are not binding statements about the suitability of products for a particular application. It is the customer's responsibility to validate that a particular product with the properties described in the product specification is suitable for use in a particular application. Parameters provided in datasheets and / or specifications may vary in different applications and performance may vary over time. All operating parameters, including typical parameters, must be validated for each customer application by the customer's technical experts. Product specifications do not expand or otherwise modify Vishay's terms and conditions of purchase, including but not limited to the warranty expressed therein.

Except as expressly indicated in writing, Vishay products are not designed for use in medical, life-saving, or life-sustaining applications or for any other application in which the failure of the Vishay product could result in personal injury or death. Customers using or selling Vishay products not expressly indicated for use in such applications do so at their own risk. Please contact authorized Vishay personnel to obtain written terms and conditions regarding products designed for such applications.

No license, express or implied, by estoppel or otherwise, to any intellectual property rights is granted by this document or by any conduct of Vishay. Product names and markings noted herein may be trademarks of their respective owners.