

This drawing involves proprietary design rights of Tyco Electronics Corporation, and all design, manufacture, reproduction, use and sale rights remaining the same are expressly reserved. It is submitted for a specific purpose and the recipient by accepting this drawing, assumes custody and control and agrees to take reasonable precautions: (a) that this drawing will not be copied and reproduced, in whole or in part, or its contents revealed in any manner, or to any person except to meet the purpose for which it was delivered and (b) that any special features peculiar to this design will not be incorporated in other projects without the expressed written permission of Tyco Electronics Corporation.

REVISIONS			
EC	REV	DESCRIPTION	DATE
CPR	A	NEW RELEASE	12/21/05

5. MODULE INFORMATION

CONNECTOR	TYCO PART NUMBER	CATALOG MODULE #	QTY	SIZE NO.	CONTACT QTY	MATING PIN	MAX. CURRENT (PER CONTACT)	CONTACT SPACING	VOLTAGE RATING*
PIN	1926021-1	FP0105	2	8	2	125 X 7.00 L049 X .276J	35 AMPERES	7.50 L2953J	250 VOLTS
		FP0106	2		2				

*IAW IEC-950

NOTES: UNLESS OTHERWISE SPECIFIED.

1. PART NUMBER CHANGES AND OR DESIGN CHANGES AFFECTING ITEM INTERCHANGEABILITY REQUIRE PRIOR ELCON APPROVAL AND AUTHORIZATION BY REVISION TO THIS DRAWING.

2. MATERIALS:

INSULATORS: THERMOPLASTIC, GLASS REINFORCED, COLOR BLACK. UL94V-0 FLAMMABILITY RATED.

POWER CONTACTS: PHOSPHOR BRONZE ALLOY,

CROWN BANDS: BERYLLIUM COPPER ALLOY.

3. FINISHES:

CONTACTS: GOLD PLATE .000030" MIN. THK, OVER NICKEL .000040" MIN. THICK

TERMINALS: TIN PLATE, MATTE FINISH .000100" MIN. THICK

4. ITEMS PROVIDED TO THIS SPECIFICATION TO BE PERMANENTLY IDENTIFIED PER THE FOLLOWING IDENTIFIER:

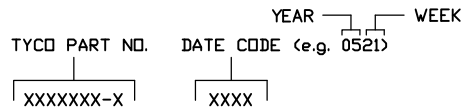

<p>THIRD ANGLE PROJECTION</p> <p>UNLESS OTHERWISE SPECIFIED DIMENSIONS ARE IN METRIC [INCHES]</p> <p>TOLERANCES</p> <p>ANGLES ± .5°</p> <p>DECIMALS</p> <p>.XX ± .25 L010J</p> <p>.X ± .5 L020J</p>	DRAWN R. F. A.	DATE 12/21/05	Tyco Electronics Corporation Menlo Park, Ca 94025	<p>TITLE</p> <p>PIN CONNECTOR, FLATPAQ RIGHT ANGLE, SOLDER TAILS</p>	
	CHECKED				
	APPROVED				
	APPROVED D. CHAU	12/21/05			
	DCA APPROVED M. ALIM		SIZE B	DWG NUMBER C = 1926021	REV. A
	ACAD FILE NUMBER	C1926021A.DWG	DWG SCALE	1=1	SH 1 OF 3

This drawing involves proprietary design rights of Tyco Electronics Corporation, and all design, manufacture, reproduction, use and sale rights involving the same are expressly reserved. It is submitted for a specific purpose and the recipient by accepting this drawing, assumes custody and control and agrees to take reasonable precautions: (a) that this drawing will not be copied and reproduced in whole or in part, or its contents revealed in any manner, or to any person except to meet the purpose for which it was delivered and (b) that any special features peculiar to this design will not be incorporated in other projects without the expressed written permission of Tyco Electronics Corporation.

REVISIONS			DATE
EC	REV	DESCRIPTION	
		SEE SHEET 1	

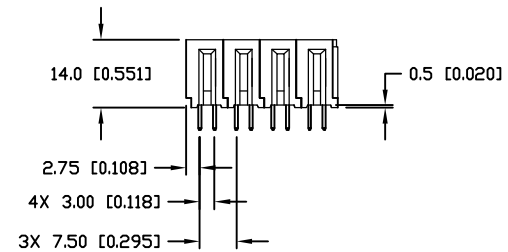
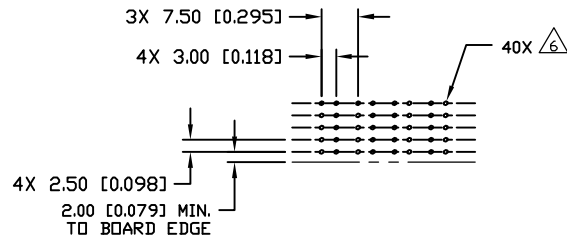
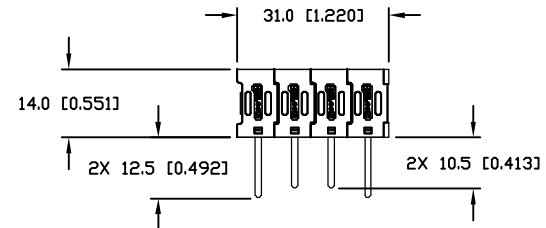
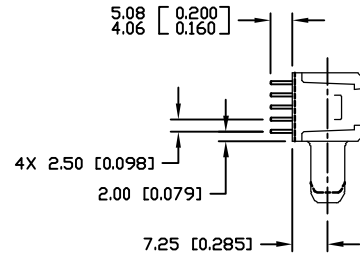

PRINTED CIRCUIT LAYOUT

← MM OR MM [INCH] THIRD ANGLE PROJECTION UNLESS OTHERWISE SPECIFIED DIMENSIONS ARE IN METRIC [INCHES] TOLERANCES ANGLES ± .5° DECIMALS .XX ± .25 [0.010] .X ± .5 [0.020]	DRAWN R. F. A.	DATE 12/21/05	 Tyco Electronics Corporation Menlo Park, Ca 94025 	TITLE PIN CONNECTOR, FLATPAQ RIGHT ANGLE, SOLDER TAILS	
	CHECKED				
	APPROVED		APPROVED D. CHAU 12/21/05		SIZE B
	APPROVED DCA APPROVED M. ALIM	ACAD FILE NUMBER	C1926021A.DWG		DWG NUMBER C = 1926021
			DWG SCALE 1=1	REV. A	
				SH 2 OF 3	

This drawing involves proprietary design rights of Tyco Electronics Corporation, and all design, manufacture, reproduction, use and sale rights pertaining thereto are expressly reserved. It is submitted for a specific purpose and the recipient by accepting this drawing, assumes entirely and controls and agrees to take reasonable precautions (a) that this drawing will not be copied and reproduced in whole or in part, or its contents revealed in any manner, or to any person except to meet the purpose for which it was delivered and (b) that any similar features similar to this design will not be incorporated in other projects without the expressed written permission of Tyco Electronics Corporation.

REVISIONS		
EC	REV	DESCRIPTION
		SEE SHEET 1
		DATE

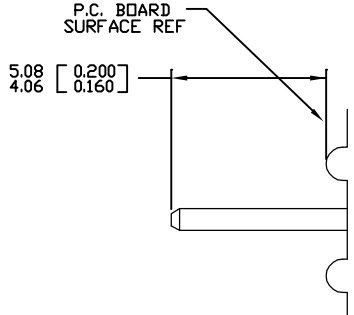

SOLDER PIN DETAIL

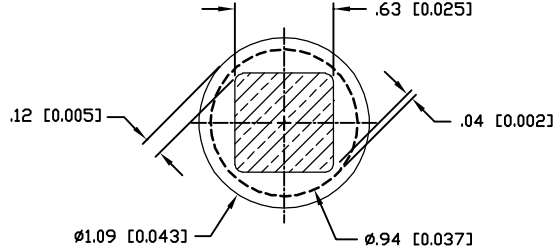

△ SOLDER TERMINATION AREA
RECOMMENDED PRINTED CIRCUIT HOLE

DRILLED HOLE: Ø1.15 [0.0453] ±.013 [0.0005]
COPPER PLATE: .025-.050 [0.001-.002] (PER SURFACE)
TIN PLATE: .0005 [0.00002] (PER SURFACE)

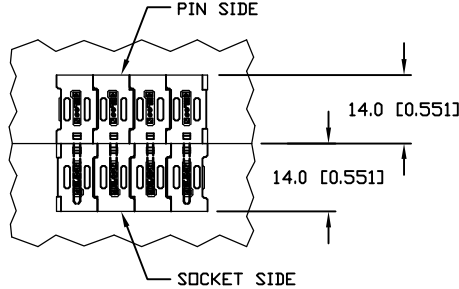
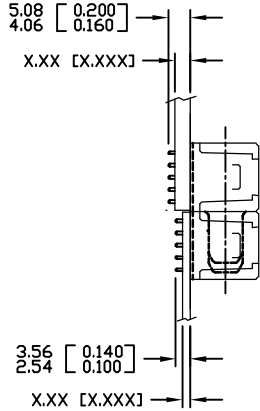

MATED CONDITION

MM OR MM [INCH] THIRD ANGLE PROJECTION UNLESS OTHERWISE SPECIFIED DIMENSIONS ARE IN METRIC [INCHES] TOLERANCES ANGLES ± .5° DECIMALS .XX ± .25 [0.010] .X ± .5 [0.020]	DRAWN R. F. A.	DATE 12/21/05	 Tyco Electronics Corporation Menlo Park, Ca 94025
	CHECKED		
	APPROVED		USER INFORMATION SOLDER TAIL TERMINATION AND MATED CONDITION
	APPROVED D. CHAU	12/21/05	
	DCA APPROVED M. ALIM		DWG NUMBER C = 1926021
	ACAD FILE NUMBER	C1926021A.DWG	REV. A
		DWG SCALE 1=1	SH 3 OF 3