

Safety Controllers F3SX

Safety, Simplicity, Visibility: Safety Controllers without Programming

- Conforms to global safety standards.
- All-in-one constructions for easy multi-input safety circuits.
- Information where you need it: LED indicators, auxiliary outputs, and serial communications.



Features

OMRON believes the fundamentals for building risk-free workplace environments are **safety, simplicity, and visibility**.

Design and implementation of safety measures and policies can be readily achieved through proven safety procedures using simple connections. Peace of mind is attained by communicating safety equipment status information (see note) in a form that is meaningful to the on-site operational and maintenance staff supporting the system.

The F3SX evolves from this philosophy.

Information:

1. Indicator output with self-diagnostic functions clearly communicates proximity warnings and work permission during operation to the operator.
2. The lighting patterns of the Safety Controller's indicators allow the operator to read the ON/OFF status of safety equipment I/O as well as error type information.
3. RS-232 communications can be used to read detailed information for the above status.

What is a Safety Controller?

Are Your Safety Inputs Connected to Your PLC Built with Interlocks?

Generally, safety is jeopardized in PLCs and other programmable control devices due to partial memory loss, CPU runaways, and situations such as on-site overwriting of programs. Using Safety Light Curtains and Safety-door Switches on their own does not necessarily ensure sufficient safety for PLC operation. Nor is safety fully secured through the use of relays in interlocks due to hazardous events that occur as a result of fused relays or short-circuited wiring.

The F3SX offers safe and simple connections for an array of safety equipment, such as Safety Light Curtains and Safety-door Switches, functioning as a central hub to perform integrated monitoring of various safety equipment.

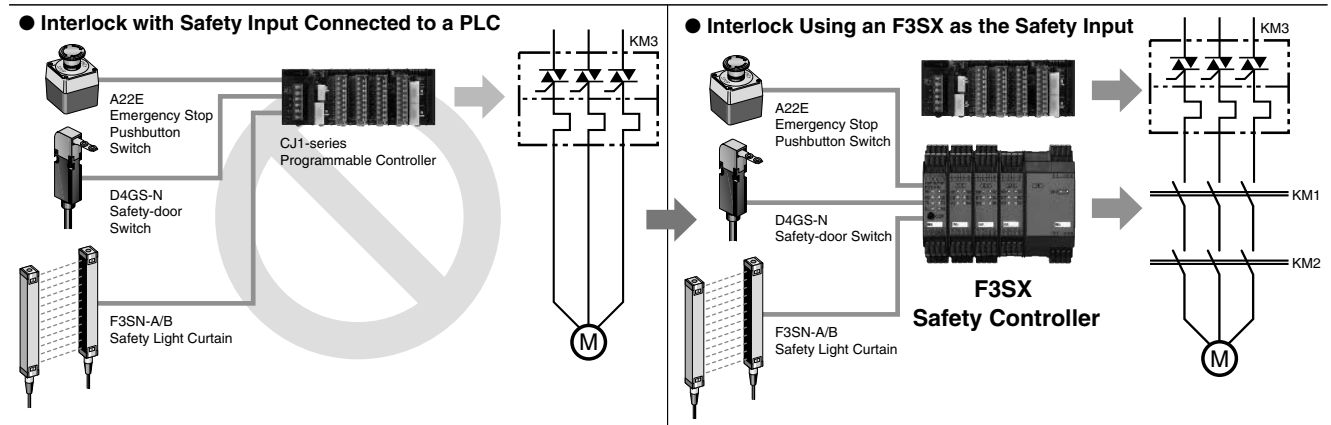

OMRON SCIENTIFIC TECHNOLOGIES, INC.
USA Tel. 1/888/510-4357 Canada Tel. 1/866/986-6766



For the Latest Information
On the Internet: www.sti.com or www.omron.ca

OMRON

Safety Networks
and Application
Controllers

F3SX

■ Configuration

**The Modular Configuration Fits Your Equipment Perfectly.
An All-in-one Solution for Delivering Required I/O**

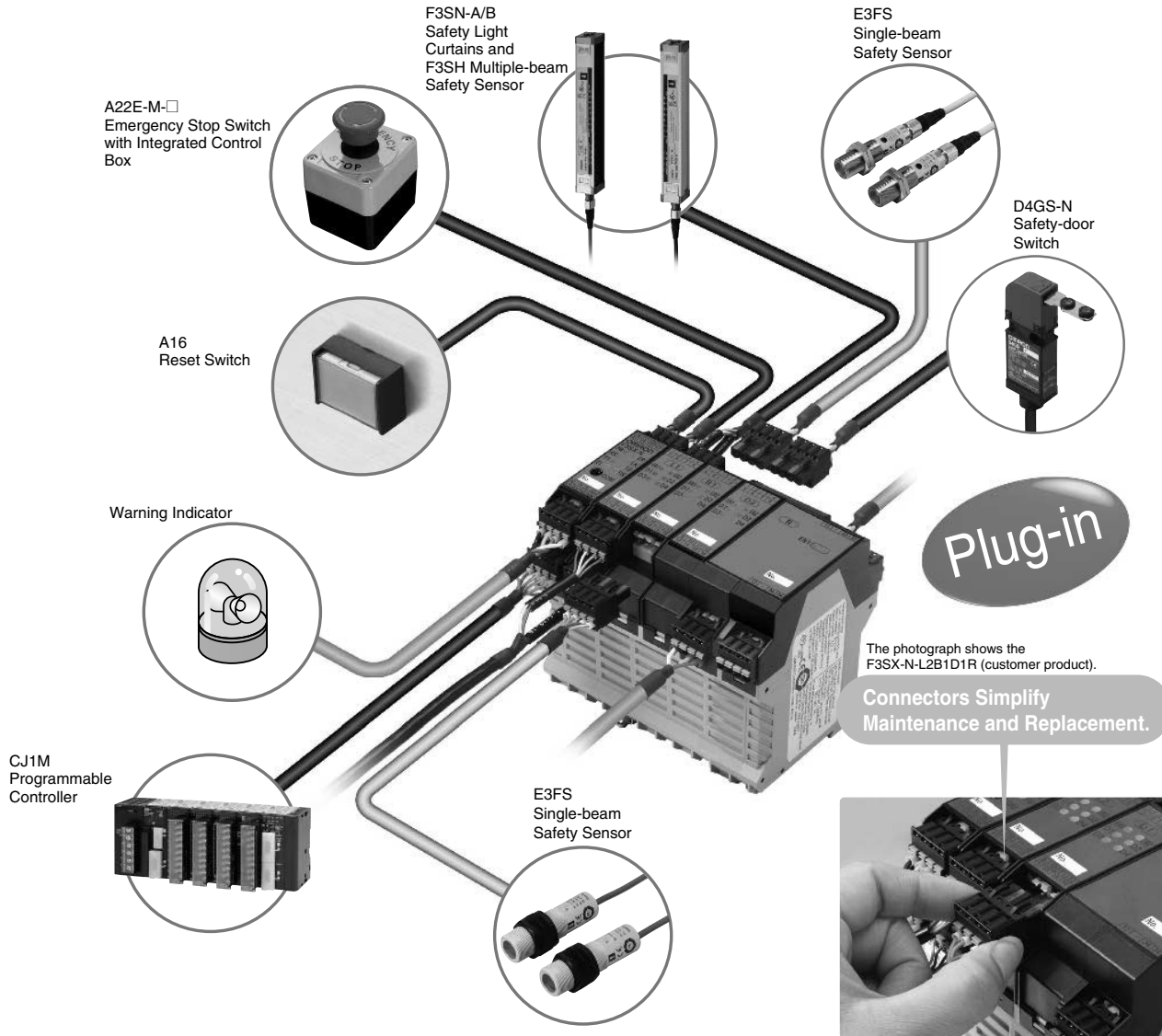

Safety Networks
and Application
Controllers
F3SX

Main Modules	Input Modules					Output Modules		
<p>N</p> <ul style="list-style-type: none"> Emergency stop input Indicator output <p>OR</p> <p>E</p> <ul style="list-style-type: none"> Emergency stop input DC solid-state safety output 	<p>L1</p> <ul style="list-style-type: none"> Two-hand Control Switch F3SN-A/B Safety Light Curtain F3SH Multiple-beam Safety Sensor <p>— One set each —</p> <p>Up to four Modules</p>	<p>L2</p> <ul style="list-style-type: none"> F3SN-A/B Safety Light Curtain F3SH Multiple-beam Safety Sensor <p>— Two sets —</p> <p>Up to two Modules (See note 1)</p>	<p>B1</p> <ul style="list-style-type: none"> E3FS Single-beam Safety Sensor <p>— Four sets —</p> <p>Up to four Modules</p>	<p>D1</p> <ul style="list-style-type: none"> D4GS-N or other Safety-door Switch F3G-C Safety Laser Scanner <p>— Two sets —</p> <p>Up to four Modules</p>	<p>M1</p> <ul style="list-style-type: none"> OME Miller Edge Safety Mats (only approved for use with this Mat Supplier) <p>— Two sets —</p>	<p>R</p> <ul style="list-style-type: none"> Non-delay (instant breaking) relay contact output (DPST-NO, SPST-NC) <p>Up to three Modules</p>	<p>R1 (See note 2)</p> <ul style="list-style-type: none"> ON-delay relay contact output (DPST-NO, SPST-NC) <p>Up to three Modules</p>	<p>R2 (See note 2)</p> <ul style="list-style-type: none"> OFF-delay relay contact output (DPST-NO, SPST-NC) <p>Up to three Modules</p>

Combine up to Five Modules as a Single Controller

(A Main Module must be included.)

Note 1: Up to four sets of F3SN-A/B Safety Light Curtains/F3SH Multiple-beam Safety Sensors can be supplied power from the F3SX. Consider this factor when selecting and wiring the Safety Controller. Up to four Modules can be connected if the Safety Light Curtains/Multiple-beam Safety Sensors are supplied power directly from an external power supply.
 Note 2: To set the delay time, use the Function Setup Software for the F3SX or specify a model with the -T□□□ suffix.



OMRON SCIENTIFIC TECHNOLOGIES, INC.
 USA Tel. 1/888/510-4357 Canada Tel. 1/866/986-6766



For the Latest Information
 On the Internet: www.sti.com or www.omron.ca



■ Safe

The Safety Controller Complies with Global Safety Standards

In addition to International standards (IEC), the F3SX also conforms to European (EN), and U.S./Canadian (UL) safety standards, enabling trouble-free use in machinery for Europe, the U.S., and Canada.

Applicable Standards

- European Machinery Directive 98/37/EC, Low Voltage Directive 73/23/EEC
- IEC 61508 1998 (EN 61508 2001) (SIL 1-3)
- EN 954-1 1996 (Category B 1-4)
- EN 50178 1997, UL 508, UL 1998, etc.



Technology-backed Safety Design

We pursued safety to the limit to deliver safety and reliability backed by the highest level of safety design and FMEA. Two CPU Units perform mutual checking and diagnostic monitoring of each I/O section, and the safety of operations is further verified by FMEA and process-controlled design and production.

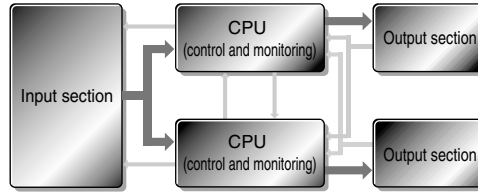

FMEA: Failure Mode & Effects Analysis

- Damage to power or circuits
- CPU runaway
- Broken or short-circuited cable
- Damage to circuit
- Damage to output
- Noise

■ Simple

Connection is Easy Using Plug-in Connectors for Even More Readily Accessible Safety

- No unnecessary wiring between Units allows considerable cuts in the cost of evaluating design safety.
- Reduced wiring, post terminals, and connector connections enable substantial reductions in the cost of maintenance labor.
- Width has been reduced by approximately 50% from 225 mm to 112.5 mm max. (compared to previous OMRON products; connecting F3SN (4 sets), F3SP-B1P, and G9SB-301).

- Post terminals aid in preventing unintentional neglect to tighten terminal screws.

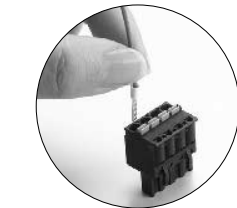
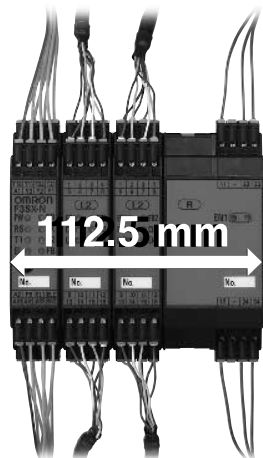

The wire colors are for reference purposes only. Refer to individual international standards for details.

- Convenient F39-TB01 Junction Box for Safety Light Curtain.

Using the Connector Cables specially designed for Safety Light Curtains/Multi-beam Safety Sensors and a Junction Box for Safety Light Curtain makes for efficient wiring to a Control Box installed at a distance.

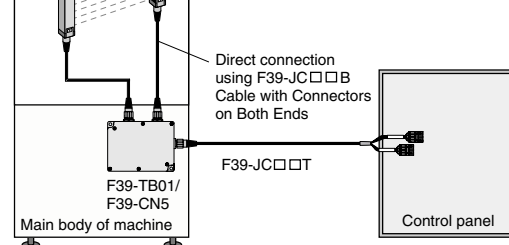

IP65f (oil-resistant)
F39-TB01
Junction Box for
Safety Light Curtain



F39-CN5
T-Connector for
Safety Light Curtains



F39-JC□□T
Connector Cable for
Safety Light Curtains

Safety Networks
and Application
Controllers
F3SX

■ Visible

Providing Meaningful Safety Equipment Information that Satisfies Needs for Safety and Peace of Mind

Previously

Majority of time lost due to failures is from investigating the causes. In particular, most time is spent in determining the location of broken lines or faulty contacts.

Indicator Displays Are Easy to Understand and More Convenient

F3SX

Shorter Downtimes!

The F3SX uses indicators to show the status of each I/O, contributing to less time (downtime) spent investigating the cause.



Safety Relay Unit



Electromagnetic Locking Door Switch

● Normal Operation

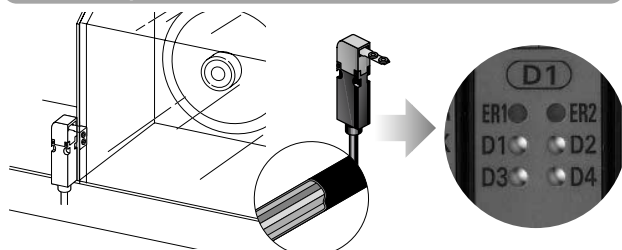

● Error

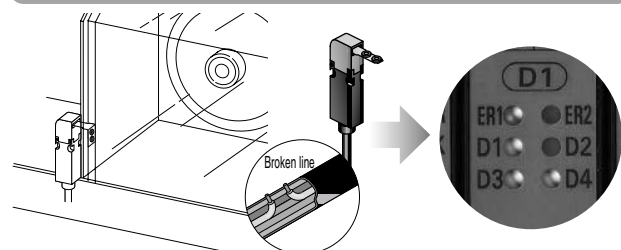

OMRON SCIENTIFIC TECHNOLOGIES, INC.
USA Tel. 1/888/510-4357 Canada Tel. 1/866/986-6766



For the Latest Information
On the Internet: www.sti.com or www.omron.ca



Applications Using Electromagnetic Lock Switches and Safety Light Curtains for Detecting Workers

Simple External Stop Input Connection

When an electromagnetic lock and Safety Light Curtain (worker detection) are used, as shown in the diagram, an external stop command input is required in addition to the Emergency Stop Switch.

Inputting a PLC operation command to the SSC input allows easy connection and control. Causes of failures can be determined from detailed communications data, which safeguards against any problem that may occur.

Indicator Lighting Pattern Shows Lock Release Timing to Operator

External indicator output lighting patterns can be utilized as work permission indicators. When equipment stops, the indicator turns ON. During OFF delays, indicator flashing gradually increases speed as the remaining time shortens to notify the operator of release timing. This contributes to increased productivity and dispels agitation due to unknown waiting times.

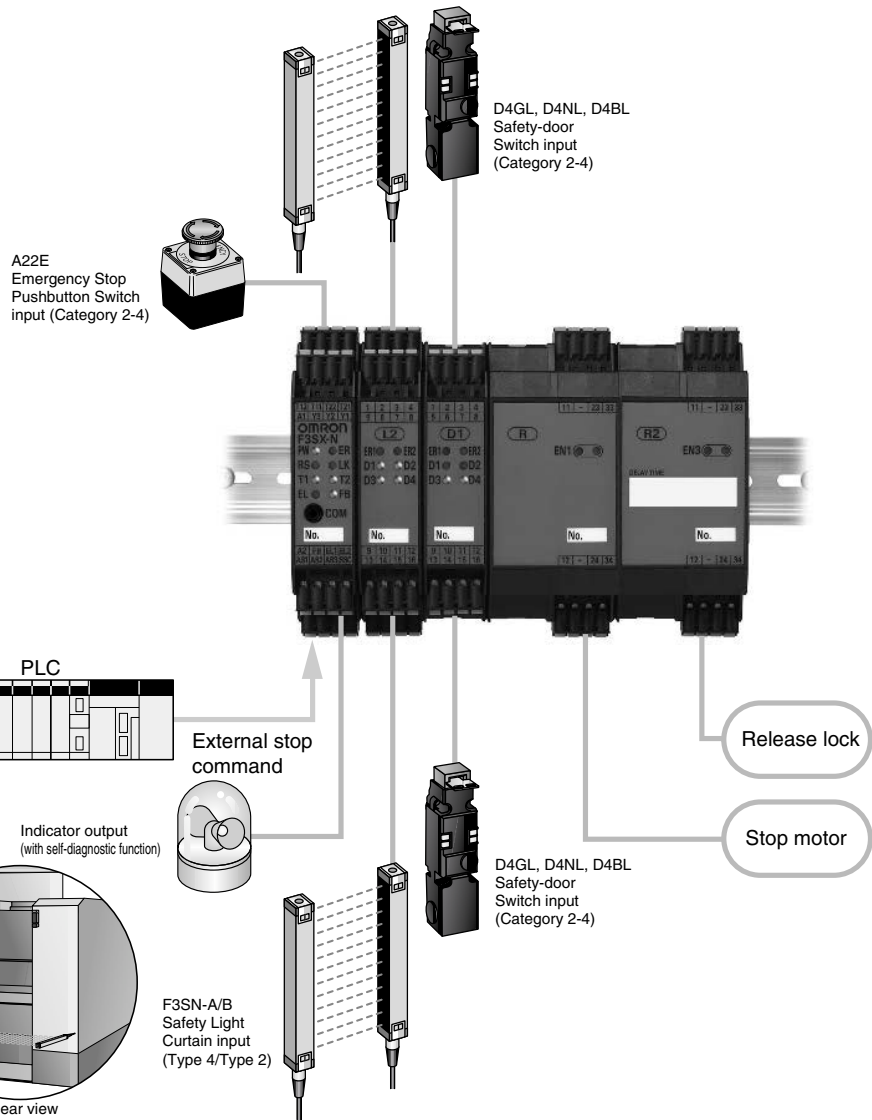

Safety Networks
and Application
Controllers
F3SX

Selection Method

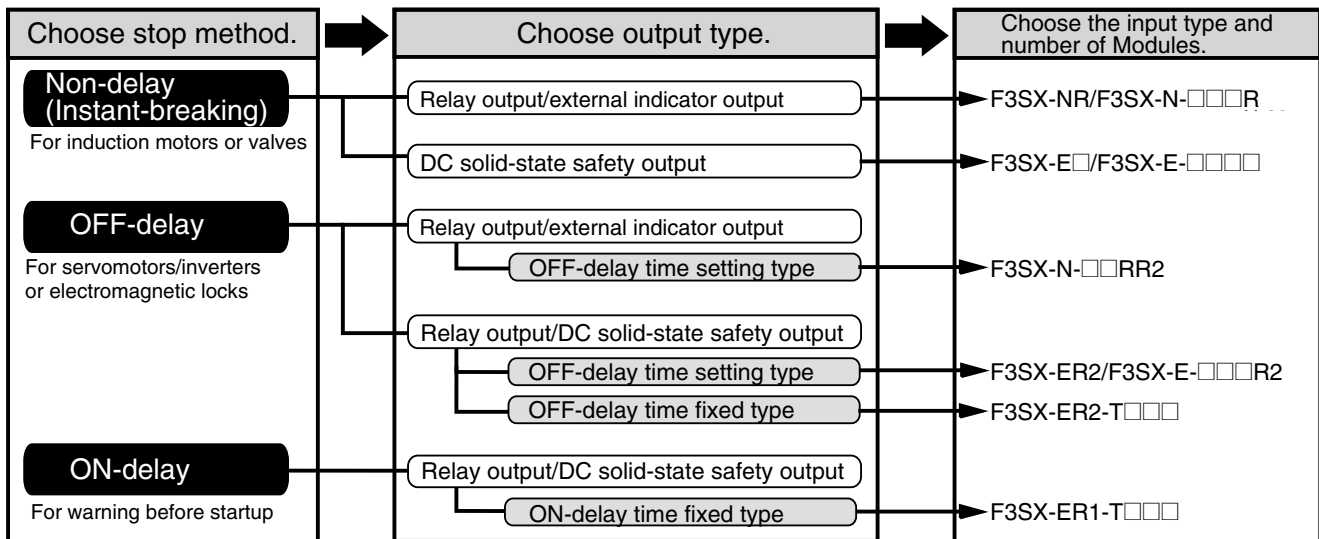

Model Number Structure and Product Configuration

■ Model Number Legend

F3SX-□□□-T□□□
 1 2 3

1. Controller Type

- E: Emergency-stop Controller with DC solid-state safety outputs
- NR: Emergency-stop Controller with safety relay output and external indicator output
- ER: Emergency-stop Controller with safety relay output and DC solid-state safety output
- EL1: Emergency Stop/Safety Light Curtain/Two-hand Control Switch Input Controller with DC solid-state safety outputs
- EL2: Emergency Stop/Safety Light Curtain Controller with DC solid-state safety outputs
- EB1: Emergency Stop/Single-Beam Sensor Input Controller with DC solid-state safety outputs
- ED1: Emergency Stop/Door Switch Input Controller with DC solid-state safety outputs
- EM1: E-Stop/Safety Mat Controller

2. Delay Time

- H: Delay time: 0.5 s × value indicated at 3. (odd numbers from TH01 to TH59)
 - N: Delay time: 1.0 s × value indicated at 3. (integers from TN01 to TN60)
 - W: Delay time: 10 s × value indicated at 3. (integers from TW07 to TW60)
- Note:** “-T□□□” is specified only in model numbers for Controllers with fixed delay times.

F3SX-□-□□-T□□□
 1 2 3 4

1. Main Module Type

- N: Main Module with external indicator output
- E: Main Module with DC solid-state safety outputs

2. I/O Module Type

- L1: Safety Light Curtain/Two-hand Control Switch Input Module
- L2: Safety Light Curtain Input Module
- B1: Single-Beam Sensor Input Module
- D1: Door Switch Input Module
- R: Relay Output Module (DPST-NO, SPST-NC): Non-delay (instant breaking) outputs (delay time cannot be set)
- R1: Relay Output Module (DPST-NO, SPST-NC): ON-delay outputs
- R2: Relay Output Module (DPST-NO, SPST-NC): OFF-delay outputs
- M1: Safety Mat Input Module

3. Delay Time

- H: Delay time: 0.5 s × value indicated at 4. (odd numbers from TH01 to TH59)
 - N: Delay time: 1.0 s × value indicated at 4. (integers from TN01 to TN60)
 - W: Delay time: 10 s × value indicated at 4. (integers from TW07 to TW60)
- Note:** 1. “-T□□□” is specified only in model numbers for Controllers with fixed delay times.
 2. In -T□□□ models, all parameters, such as delay time and auxiliary solid-state outputs, are set at the factory. Therefore, these parameters cannot be changed using the Function Setup Software (F3SX-CD□□□) for the F3SX.

Product Configuration

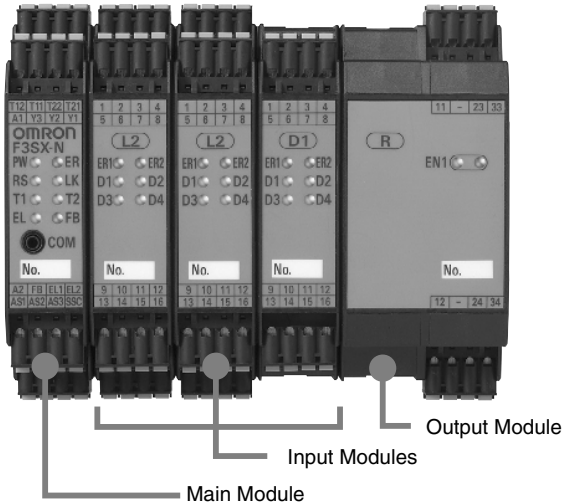

The Controller has a modular configuration comprised of a combination of Main Modules, Input Modules, and Output Modules, as shown in the diagram at the left.

For information on non-standard I/O combinations, contact your OMRON sales representative.

List of Models

Main Modules

Non-delay (Instant Breaking) Models

Output type	Non-delay (instant breaking) outputs		Model
	Solid-state outputs	Contact outputs	
Indicator output + contact output	None	Main contact (DPST-NO) Auxiliary contact (SPST-NC)	F3SX-NR F3SX-N-□□□R
Solid-state output	2 safety outputs 1 auxiliary output	None	F3SX-E□ F3SX-E-□□□□

Note: Models with multiple contact outputs are also available (RR/RRR).

OFF-delay Time Setting Models

Output type	Non-delay (instant breaking) outputs		OFF-delay outputs	Model
	Solid-state outputs	Contact outputs	Contact outputs	
Indicator output + contact output	None	Main contact (DPST-NO) Auxiliary contact (SPST-NC)	Main contact (DPST-NO) Auxiliary contact (SPST-NC)	F3SX-N-□□RR2
Solid-state output + contact output	2 safety outputs 1 auxiliary output	None	Main contact (DPST-NO) Auxiliary contact (SPST-NC)	F3SX-ER2 F3SX-E-□□□R2

Note: The OFF-delay time for R2 models is factory-set to 0.0 s (non-delay (instant breaking)).

OFF-delay Time Fixed Models

Output type	Non-delay (instant breaking) outputs	OFF-delay outputs	OFF-delay time	Model
	Solid-state outputs	Contact outputs		
Solid-state output + contact output	2 safety outputs 1 auxiliary output	Main contact (DPST-NO) Auxiliary contact (SPST-NC)	0.5 s to 29.5 s (0.5-s intervals)	F3SX-ER2-TH□□
			1 s to 60 s (1-s intervals)	F3SX-ER2-TN□□
			70 s to 600 s (10-s intervals)	F3SX-ER2-TW□□

Note: The Function Setup Software for the F3SX cannot be used to change the settings for the above OFF-delay time fixed models.

ON-delay Time Fixed Models

Output type	Non-delay (instant breaking) outputs	ON-delay outputs	ON-delay time	Model
	Solid-state outputs	Contact outputs		
Solid-state output + contact output	2 safety outputs 1 auxiliary output	Main contact (DPST-NO) Auxiliary contact (SPST-NC)	1 to 60 s (1-s intervals)	F3SX-ER1-TN□□

Note: The Function Setup Software for the F3SX cannot be used to change the settings for the above ON-delay time fixed models.

All models:

For details on models with □□ shown in the model numbers, refer to "List of Models" on page EE-94.

Function Setup Software for the F3SX (English Version)

Appearance	Supported OS	Model
	Windows 98SE or higher (see note), Windows 2000 SP4 or higher, or Windows XP SP1 or higher	F3SX-CD100-E

Note: 1. IE4.0 or higher must be installed.



2. The F3SX-CD100-E Function Setup Software (SCHG-705B) is not included and must be purchased separately. Contact your OMRON representative for details.

Setting Functions

- Delay time settings (ON-delay/OFF-delay)
- Monitoring time settings
- Indicator lighting pattern settings (F3SX-N only)
- Auxiliary outputs (AS1/AS2/AS3)
- Log read (feedback time for past 16 operations)
- Intersystem monitoring time (for past 16 operations), error log
- I/O monitor

An RS-232C cable (F39-JC2X1, sold separately) is required to use the Function Setup Software for the F3SX.

■ Accessories (Sold Separately)**Junction Box for Safety Light Curtain**

Appearance	Connecting devices	Model
	F3SN-A/-B ↑ F3SX Series	F39-TB01
		F39-CN5

Cable with Connectors on Both Ends

Appearance	Connecting devices	Model	Cable length
	F3SN-A/-B ↑ F3SX Series	F39-JC1T	1 m
		F39-JC3T	3 m
		F39-JC5T	5 m
		F39-JC10T	10 m

RS-232C Cable (9-pin D-Sub Connector)

Appearance	Connecting devices	Model	Cable length
	RS-232C cable for connecting F3SX to personal computer	F39-JC2X1	2 m
	RS-232C cable for connecting F3SX to OMRON PLC	F39-JC2X2	2 m

List of Models

■ Non-delay (Instant Breaking) Models

F3SX-NR, F3SX-N-□□□R (with External Indicator Output)

Input type				Model	Width (See note.)	Weight (Main Module only)
Emergency Stop	F3SN-A/F3SH-A Safety Light Curtain	Two-hand Control Switch	Door Switch			
1 set	---	---	---	F3SX-NR	45.0 mm	Approx. 0.3 kg
1 set	---	---	2 sets	F3SX-N-D1R	90.0 mm	Approx. 0.5 kg
1 set	---	---	4 sets	F3SX-N-D1D1R	112.5 mm	Approx. 0.6 kg
1 set	---	---	6 sets	F3SX-N-D1D1D1R	135.0 mm	Approx. 0.7 kg
1 set	2 sets	---	---	F3SX-N-L2R	67.5 mm	Approx. 0.5 kg
1 set	4 sets	---	---	F3SX-N-L2L2R	112.5 mm	Approx. 0.6 kg
1 set	2 sets	---	2 sets	F3SX-N-L2D1R	112.5 mm	Approx. 0.6 kg
1 set	4 sets	---	2 sets	F3SX-N-L2L2D1R	135.0 mm	Approx. 0.7 kg
1 set	2 sets	---	4 sets	F3SX-N-L2D1D1R	135.0 mm	Approx. 0.7 kg
1 set	1 set	1 set	---	F3SX-N-L1R	90.0 mm	Approx. 0.5 kg
1 set	1 set	1 set	2 sets	F3SX-N-L1D1R	112.5 mm	Approx. 0.6 kg
1 set	1 set	1 set	4 sets	F3SX-N-L1D1D1R	135.0 mm	Approx. 0.7 kg

Note: For details on the width, refer to "Dimensions" on page EE-105.

F3SX-E□/F3SX-E-□□□□ (with DC Solid-state Safety Output)

Input type				Model	Width (See note.)	Weight (Main Module only)
Emergency Stop	F3SN-A/F3SH-A Safety Light Curtain	Two-hand Control Switch	Door Switch			
1 set	---	---	---	F3SX-E	22.5 mm	Approx. 0.3 kg
1 set	---	---	2 sets	F3SX-ED1	45.0 mm	Approx. 0.3 kg
1 set	---	---	4 sets	F3SX-E-D1D1	67.5 mm	Approx. 0.4 kg
1 set	---	---	6 sets	F3SX-E-D1D1D1	90.0 mm	Approx. 0.5 kg
1 set	---	---	8 sets	F3SX-E-D1D1D1D1	112.5 mm	Approx. 0.6 kg
1 set	2 sets	---	---	F3SX-EL2	45.0 mm	Approx. 0.3 kg
1 set	2 sets	---	2 sets	F3SX-E-L2D1	67.5 mm	Approx. 0.4 kg
1 set	2 sets	---	4 sets	F3SX-E-L2D1D1	90.0 mm	Approx. 0.5 kg
1 set	2 sets	---	6 sets	F3SX-E-L2D1D1D1	112.5 mm	Approx. 0.6 kg
1 set	4 sets	---	---	F3SX-E-L2L2	67.5 mm	Approx. 0.4 kg
1 set	4 sets	---	2 sets	F3SX-E-L2L2D1	90.0 mm	Approx. 0.5 kg
1 set	4 sets	---	4 sets	F3SX-E-L2L2D1D1	112.5 mm	Approx. 0.6 kg
1 set	1 set	1 set	---	F3SX-EL1	45.0 mm	Approx. 0.3 kg
1 set	1 set	1 set	2 sets	F3SX-E-L1D1	67.5 mm	Approx. 0.4 kg
1 set	1 set	1 set	4 sets	F3SX-E-L1D1D1	90.0 mm	Approx. 0.5 kg
1 set	1 set	1 set	6 sets	F3SX-E-L1D1D1D1	112.5 mm	Approx. 0.6 kg

Note: 1. Refer to OME/F3SX for combinations with M1 Modules.
2. Refer to E3FS for combinations with B1 Modules.

Safety Networks and Application Controllers
F3SX

■ OFF-delay Time Setting Models (Using Function Setup Software for the F3SX)

F3SX-N-□□RR2

Input type				Model	Width (See note 3.)	Weight (Main Module only)
Emergency Stop	F3SN-A/F3SH-A Safety Light Curtain	Two-hand Control Switch	Door Switch			
1 set	---	---	---	F3SX-N-RR2	112.5 mm	Approx. 0.5 kg
1 set	---	---	2 sets	F3SX-N-D1RR2	135.0 mm	Approx. 0.6 kg
1 set	---	---	4 sets	F3SX-N-D1D1RR2	157.5 mm	Approx. 0.7 kg
1 set	2 sets	---	---	F3SX-N-L2RR2	135.0 mm	Approx. 0.6 kg
1 set	2 sets	---	2 sets	F3SX-N-L2D1RR2	157.5 mm	Approx. 0.7 kg
1 set	4 sets	---	---	F3SX-N-L2L2RR2	157.5 mm	Approx. 0.7 kg
1 set	1 set	1 set	---	F3SX-N-L1RR2	135.0 mm	Approx. 0.6 kg
1 set	1 set	1 set	2 sets	F3SX-N-L1D1RR2	157.5 mm	Approx. 0.7 kg

- Note:** 1. The factory setting for the OFF-delay time is 0 s (non-delay (instant breaking)).
 2. By using the Function Setup Software for the F3SX (F3SX-CD100-E, sold separately), the time can be set in 0.1-second units.
 3. For details on the width, refer to "Dimensions" on page EE-105.

F3SX-ER2/F3SX-E-□□□R2

Input type				Model	Width (See note.)	Weight (Main Module only)
Emergency Stop	F3SN-A/F3SH-A Safety Light Curtain	Two-hand Control Switch	Door Switch			
1 set	---	---	---	F3SX-ER2	45.0 mm	Approx. 0.3 kg
1 set	---	---	2 sets	F3SX-E-D1R2	90.0 mm	Approx. 0.5 kg
1 set	---	---	4 sets	F3SX-E-D1D1R2	112.5 mm	Approx. 0.6 kg
1 set	---	---	6 sets	F3SX-E-D1D1D1R2	135.0 mm	Approx. 0.7 kg
1 set	2 sets	---	---	F3SX-E-L2R2	90.0 mm	Approx. 0.5 kg
1 set	2 sets	---	2 sets	F3SX-E-L2D1R2	112.5 mm	Approx. 0.6 kg
1 set	2 sets	---	4 sets	F3SX-E-L2D1D1R2	135.0 mm	Approx. 0.7 kg
1 set	4 sets	---	---	F3SX-E-L2L2R2	112.5 mm	Approx. 0.6 kg
1 set	4 sets	---	2 sets	F3SX-E-L2L2D1R2	135.0 mm	Approx. 0.7 kg
1 set	1 set	1 set	---	F3SX-E-L1R2	90.0 mm	Approx. 0.5 kg
1 set	1 set	1 set	2 sets	F3SX-E-L1D1R2	112.5 mm	Approx. 0.6 kg
1 set	1 set	1 set	4 sets	F3SX-E-L1D1D1R2	135.0 mm	Approx. 0.7 kg

- Note:** 1. The factory setting for the OFF-delay time is 0 s (non-delay (instant breaking)).
 2. By using the Function Setup Software for the F3SX (F3SX-CD100-E, sold separately), the time can be set in 0.1-second units.
 3. For details on the width, refer to "Dimensions" on page EE-105.

■ OFF-delay Time Fixed Models

F3SX-ER2-T□□□

-TH01 to -TH59 (odd model numbers only) (0.5-second units)		-TN01 to -TN60 (1.0-second units)				-TW07 to -TW60 (10-second units)	
Model suffix -T□□□	Set time	Model suffix -T□□□	Set time	Model suffix -T□□□	Set time	Model suffix -T□□□	Set time
-TH01	0.5 s	-TN01	1 s	-TN10	10 s	-TW07	70 s
-TH03	1.5 s	-TN02	2 s	-TN20	20 s	-TW08	80 s
-TH05	2.5 s	-TN03	3 s	-TN30	30 s	-TW09	90 s
-TH07	3.5 s	-TN04	4 s	-TN40	40 s	-TW10	100 s
-TH09	4.5 s	-TN05	5 s	-TN50	50 s	-TW20	200 s
-TH11	5.5 s	-TN06	6 s	-TN60	60 s	-TW30	300 s
-TH13	6.5 s	-TN07	7 s	---	---	-TW40	400 s
-TH15	7.5 s	-TN08	8 s	---	---	-TW50	500 s
-TH17	8.5 s	-TN09	9 s	---	---	-TW60	600 s

- Note 1.** It is not possible to change the factory settings for delay time or any other parameters.
 2. The set time can be customized at the factory to a user-preferred time, provided that it is within the model standards. Contact your OMRON representative for details.

■ ON-delay Time Fixed Models

F3SX-ER1-T□□□

1 to 5 s (1.0-second units)	
Model suffix -T□□□	Set time
-TN01	1 s
-TN02	2 s
-TN03	3 s
-TN04	4 s
-TN05	5 s

- Note:** 1. It is not possible to change the factory settings for delay time or any other parameters.
2. Delay times of up to 60 s in 1.0-s increments can be manufactured for Controllers with Fixed ON-delay times.

Ratings and Characteristics

■ General Specifications

Common Specifications

Item	Ratings/Characteristics
Safety category (EN 954-1)	Category 4
Safety standards (IEC 61508)	SIL3
Rated supply voltage	24 VDC \pm 10% (ripple p-p 10% max.)
Startup time	5 s max.
Control circuit protection	Output short-circuit protection, power supply reverse polarity protection (See note.)
Overvoltage category (IEC60664-1)	II
Insulation resistance	100 M Ω (500 VDC) between all lead wires and outer case
Dielectric strength	2,200 VAC, 50/60 Hz for 1 min between all lead wires and outer case
Ambient temperature	Operating: -10 to 50°C (with no icing or condensation) Storage: -30 to 70°C (with no icing or condensation)
Ambient humidity	Operating and storage: 35% to 85% (with no icing or condensation)
Vibration resistance	10 to 55 Hz, double amplitude: 0.7 mm, X, Y and Z directions, 20 sweeps (power ON)
Shock resistance	100 m/s ² , X, Y and Z directions, 1,000 times (power ON)
Case material	Glass fiber-reinforced polyamide 66 (PA-66-FR)
Degree of protection	Terminal block: IP20 Main body: IP40 (IEC 60529)

Note: If the protective function operates, turn ON the power again to recover.

Main Modules with External Indicator Output (N Modules)

I/O		Ratings/Characteristics
Input	Emergency stop input	ON: 15 to 24 VDC $\pm 10\%$ OFF: Open or 0 to 5 VDC max. Internal impedance: Approx. 5 k Ω
	Reset input	
	Feedback input	
	Auxiliary input	
DC solid-state output	External indicator output (See note 1.)	Connectable indicators: Filament types (incandescent lamp) 24 VDC, 3 to 7 W
	Auxiliary solid-state output	PNP transistor output Load current: 25 mA max. Residual voltage: 2 V max. (See note 4.)

Note: 1. When external indicators are not connected, connect resistance (1/4 W, 4.7 k Ω) between the EL1 terminal and EL2 terminal. The lead wire resistance (without polarity) shown in the following diagram is included with the product.

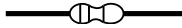

2. LED indicators (ratings: 24 VDC, 0.7 to 7 W) can also be connected. Diagnostic checks, however, cannot be performed if LED indicators are connected.

3. OMRON recommends the following indicators (both have a power consumption of 5 W).

- PS-24-Y B0568: Manufactured by PATLITE Corporation (Always use an incandescent lamp as a replacement indicator. The malfunction monitoring using current detection will not function if LED indicators are used.)
- ASSC-24: Manufactured by ARROW ELECTRONICS IND. CO., LTD.



PS-24-Y-B0568
(by PATLITE Corporation)

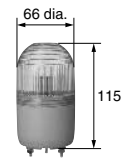

ASSC-24
(by ARROW ELECTRONICS IND. CO., LTD.)

4. Except for voltage drop due to cable extension.

Main Modules with DC Solid-state Safety Output (E Modules)

Item		Ratings/Characteristics
Input	Emergency stop input	ON: DC15 to 24 V $\pm 10\%$ OFF: Open or 0 to 5 VDC max. Internal impedance: Approx. 5 k Ω
	Reset input	
	Feedback input	
	Auxiliary input	
DC solid-state output	DC solid-state safety output	PNP transistor output Load current: 300 mA max. (resistance load/inductive load) (See note 1.) Residual voltage (when ON): 2 V max. (See note 2.) Residual voltage (when OFF): 0.1 V max. Leakage current (when OFF): 0.1 mA max. Allowable capacitive load: 1 μ F max. Allowable wire resistance between output terminals and load: 4 Ω max.
	Auxiliary solid-state output	PNP transistor output Load current: 25 mA max; Residual voltage: 2 V max. (See note 2.)

Note: 1. With an inductive load, connect a diode or other surge absorber parallel to the load.

2. Except for voltage drop due to cable extension.

■ Relay Output Modules

R Modules: Delay time cannot be set.

R1 Modules: ON-delay can be set.

R2 Modules: OFF-delay can be set.

Item				Ratings/Characteristics
Relay contact outputs	Number of main contacts (safety outputs)			2 (DPST-NO)
	Number of auxiliary contacts (auxiliary outputs)			1 (SPST-NC)
	Rated load	Resistive load	Terminals 11/12 (Auxiliary contact: Auxiliary output)	250 V AC, 50/60Hz, 30 VDC at 5A
			Terminals 23/24 Terminals 33/34 (Main contacts: Safety outputs)	250 V AC, 50/60Hz, 30 VDC at 3.15 A (5 A) (See note 1.)
	Inductive load		AC15: 240 V AC at 2 A $\cos\phi = 0.3$ DC13: 24 VDC at 1 A L/R = 48 ms	
	Minimum permissible load (See note 2.)			24 VDC at 5 mA (reference value) (See note 3.)
	Electrical durability (See note 2.)			100,000 operations min. (switching frequency: 1,800 times/hr)
Mechanical durability (See note 2.)			10,000,000 operations min. (switching frequency: 36,000 times/hr)	

Note: 1. An external fuse must be connected to the safety relay output. The safety category depends on the fuse rating:

- 1) Safety Category 4 (EN954-1)
A fuse rated at 3.15 A max. must be connected externally to protect the safety relay output from contact welding. The current that can be applied to the relay contacts is limited by the fuse rating to 3.15 A max. (resistive load).
- 2) Safety Category 3 (EN954-1) or lower
A fuse rated at 5 A max. must be connected externally to protect the safety relay output from contact welding. The current that can be applied to the relay contacts is limited by the fuse rating to 5 A max. (resistive load). For details, refer to section 10.4.3.4 of prEN50156-1.
2. This rating is for Modules with built-in relays. The durability conditions are an ambient temperature of 15 to 35°C and an ambient humidity of 25% to 75%.
3. This value is a reference value. The Modules are not designed to be used below this value. If a large load is applied even once, switching may not be possible for microloads.

Rated Current

The rated current depends on the type and number of Modules used, as shown below.

Module type	Rated current
Main Module (E, N)	150 mA
Input Module (L1, L2, D1)	150 mA
Relay Output Module (R, R1, R2)	100 mA

Example:

F3SX-N-L2L2R: 150 (N Module) + 150 (L2 Module) + 150 (L2 Module) + 100 (R Module) = 550 mA

Response Time

Non-delay (Instant Breaking) Models

Model (N Modules)	Relay outputs		Auxiliary output (AS1)	
	ON → OFF	OFF → ON	ON → OFF	OFF → ON
F3SX-NR	35 ms	135 ms	25 ms	105 ms
F3SX-N-□R	35 ms	135 ms	25 ms	105 ms
F3SX-N-□□R	40 ms	156 ms	30 ms	126 ms
F3SX-N-□□□R	45 ms	177 ms	35 ms	147 ms

ON-delay/OFF-delay Time Setting Models

Model (N Modules)	Relay outputs		Auxiliary output (AS1)	
	ON → OFF (See note 2.)	OFF → ON (See note 1.)	ON → OFF	OFF → ON
F3SX-N-RR1 (See note 1.) F3SX-N-RR2 (See note 2.)	35 ms	135 ms	25 ms	105 ms
F3SX-N-□RR1 (See note 1.) F3SX-N-□RR2 (See note 2.)	40 ms	156 ms	30 ms	126 ms
F3SX-N-□□RR1 (See note 1.) F3SX-N-□□RR2 (See note 2.)	45 ms	177 ms	35 ms	147 ms



- Note 1.** R1 Modules (terminals 23/24, 33/34) support an ON-delay time setting using the Function Setup Software for the F3SX (F3SX-CD100-E). The ON-delay time is factory-set to 0 s (non-delay (instant breaking)).
- 2.** R2 Modules (terminals 23/24, 33/34) support an OFF-delay time setting using the Function Setup Software for the F3SX (F3SX-CD100-E). The OFF-delay time is factory-set to 0 s (non-delay (instant breaking)).
- 3.** The actual ON-delay time (time from interlock reset until output occurs) and OFF-delay time (time from when input turns OFF until output turns OFF) is calculated by adding the applicable times shown in the above table to the user-set time.
Example: If the OFF-delay for an F3SX-N-RR2 is set to 0.5 s (500 ms), the actual OFF-delay is 500 + 35 = 535 ms.

Non-delay (Instant Breaking) Models

Model (E Modules)	Relay outputs		DC solid-state safety output, auxiliary output	
	ON → OFF	OFF → ON	ON → OFF	OFF → ON
F3SX-E	---	---	25 ms	105 ms
F3SX-E-□	35 ms	135 ms	25 ms	105 ms
F3SX-E-□□	35 ms	135 ms	25 ms	105 ms
F3SX-E-□□□	40 ms	156 ms	30 ms	126 ms
F3SX-E-□□□□	45 ms	177 ms	35 ms	147 ms

ON-delay/OFF-delay Time Setting Models

Model (E Modules)	Relay outputs		DC solid-state safety output, auxiliary output	
	ON → OFF (See note 2.)	OFF → ON (See note 1.)	ON → OFF	OFF → ON
F3SX-ER1 (See note 1.) F3SX-ER2 (See note 2.)	35 ms	135 ms	25 ms	105 ms
F3SX-E-□R1 (See note 1.) F3SX-E-□R2 (See note 2.)	35 ms	135 ms	25 ms	105 ms
F3SX-E-□□R1 (See note 1.) F3SX-E-□□R2 (See note 2.)	40 ms	156 ms	30 ms	126 ms
F3SX-E-□□□R1 (See note 1.) F3SX-E-□□□R2 (See note 2.)	45 ms	177 ms	35 ms	147 ms

- Note: 1.** R1 Modules (terminals 23/24, 33/34) support an ON-delay time setting using the Function Setup Software for the F3SX (F3SX-CD100-E). The ON-delay time is factory-set to 0 s (non-delay (instant breaking)).
- 2.** R2 Modules (terminals 23/24, 33/34) support an OFF-delay time setting using the Function Setup Software for the F3SX (F3SX-CD100-E). The OFF-delay time is factory-set to 0 s (non-delay (instant breaking)).
- 3.** The actual ON-delay time (time from interlock reset until output occurs) and OFF-delay time (time from when input turns OFF until output turns OFF) is calculated by adding the applicable times shown in the above table to the user-set time.
Example: If the OFF-delay for an F3SX-E-D1D1D1R2 is set to 1 s (1,000 ms), the actual OFF-delay is 1,000 + 45 = 1,045 ms.

Safety Output Monitor (AS1 Terminal: N/E Modules)

The safety output monitor outputs synchronously with the safety outputs (non-delay (instant breaking)).

Operation Diagram



WARNING

AS1, AS2, and AS3 are not safety outputs and cannot be used to configure a safety system. Doing so may result in serious injury if the F3SX or peripheral devices malfunction.

Terminal Arrangement

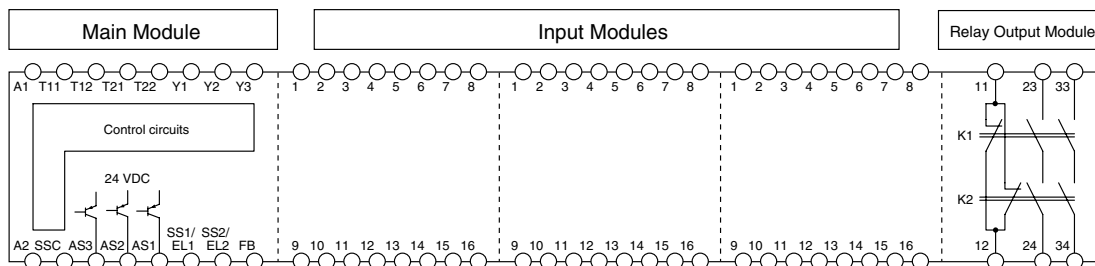









Main Modules

Item	Terminal No.	Function	
		Model: F3SX-N	Model: F3SX-E
Power supply inputs	A1	24-VDC input	
	A2	GND (0 V) input	
Emergency stop inputs (See note 1.)	T11	Emergency Stop Switch inputs	
	T12		
	T21		
	T22		
Reset inputs	Y1	Reset inputs: Auto/manual reset selection, system reset	
	Y2		
	Y3		
Feedback input	FB	Feedback time monitor (500 ms max.)	
Auxiliary solid-state outputs (See note 2.)	AS1	Safety output monitor (standard setting: Outputs synchronously with the safety output)	
	AS2	Information trigger (Standard setting: Outputs error information, information on excessive output switching, and information on excessive ON time)	Ready output (Standard setting: Outputs when safety inputs are all ON.)
	AS3	Standby output (Standard setting: Outputs after power is turned ON, the F3SX has been initialization, and I/O can be normally controlled.)	
Auxiliary input (See note 3.)	SSC	Start command input (soft-start circuit)	
External indicator outputs (See note 4.)	EL1	Indicator input with diagnostic functions (+: sourcing)	---
	EL2	Indicator input with diagnostic functions (-: sinking)	---
DC solid-state safety outputs	SS1	---	DC solid-state safety output 1
	SS2	---	DC solid-state safety output 2
RS-232C port	COM	RS-232C port for connecting communications cable	

- Note:**
- If the emergency stop switch is not necessary, directly connect terminal T11 to T12, and terminal T21 to T22.
 - The Function Setup Software for the F3SX (F3SX-CD100-E, sold separately) can be used to change function settings for the auxiliary solid-state output terminals (AS1, AS2, and AS3), and the external indicator output. For details refer to the *Help* menu in the F3SX-CD100-E.
 - When the start command input (SSC) is not necessary, directly connect the SSC terminal to the 24 VDC input terminal (A1 terminal).
 - When an external indicator is not necessary, connect resistance (1/4 W, 4.7 kΩ) between the terminals EL1 and EL2.

Indicator Display, Lighting Patterns, and Meanings

ER indicator	Meaning	Cause	Remedy
 Lit	Emergency stop switch input sync error	Emergency stop switch contact is faulty or emergency stop switch wiring is incorrect.	Check the wiring to the emergency stop switch.
 1-time flashing	Short-circuit/wiring error between emergency stop switch inputs	The wiring to the emergency stop switch has short-circuited.	Check the emergency stop switch and wiring.
 2-time flashing	Emergency stop switch input terminal circuit error	The emergency stop switch input terminal is faulty.	Replace the F3SX.
		Excessive noise is affecting the F3SX.	Check the noise conditions around the F3SX.
 3-time flashing	Reset input terminal error	The wiring to the reset input terminal is incorrect.	Check the wiring to the reset input terminal.
		The wiring to the reset input terminal is broken or short-circuited.	Check the wiring to the reset input terminal.
		The reset input terminal circuit is faulty.	Replace the F3SX.
 4-time flashing	External indicator output terminal error (F3SX-N)	The external indicator output circuit is faulty.	Replace the external indicator.
		The wiring to the external indicator output circuit is incorrect	Check the wiring to the external indicator.
		An error has occurred in the external indicator output circuit.	Replace the F3SX.
	DC solid-state safety output terminal error (F3SX-E)	The load (external device) is faulty.	Replace the load (external device).
The wiring to the load (external device) is incorrect.		Check the wiring to the load (external device).	
An error has occurred in the DC solid-state safety output circuit.		Replace the F3SX.	
 5-time flashing	Relay output terminal error (See note.)	The relay output is faulty.	Replace the F3SX.
		Excessive noise is affecting the F3SX.	Check the noise conditions around the F3SX.
 6-time flashing	Feedback input terminal error	The wiring to the contactor or other external device is incorrect.	Check the wiring to the contactor or other external devices.
		The contactor or other external device is faulty.	Replace the contactor or other external device.
 Continuously flashing	Noise or F3SX malfunction	Excessive noise is affecting the F3SX.	Check the noise conditions around the F3SX.
		The F3SX's internal circuits are faulty.	Replace the F3SX.

Note: This error does not occur in F3SX Safety Controllers configured without a Relay Output Module.

Input Modules

L1

Terminal No.	Connection	
1	Not used.	Two-hand Control Switch
2	2hand-SW S32 NC contact	
3	Not used.	
4	2hand-SW S31 NC contact	
5	2hand-SW S32 NO contact	
6	2hand-SW S32 COMMON	
7	2hand-SW S31 NO contact	
8	2hand-SW S31 COMMON	
9	Test input	F3SN-A Safety Light Curtain or F3SH-A Multi-beam Safety Sensor
10	Control output 2	
11	Reset input	
12	Control output 1	
13	RS-485 (B)	
14	RS-485 (A)	
15	0 V	
16	+24 V	

Note: For details on the signals and wiring of Two-hand Control Switches, refer to "F3SX-N-L1D1R Auto-reset Circuit Example" on page EE-103.

L2

Terminal No.	Connection	
1	+24 V	F3SN-A Safety Light Curtain or F3SH-A Multi-beam Safety Sensor (first set)
2	0 V	
3	RS-485 (A)	
4	RS-485 (B)	
5	Control output 1	
6	Reset input	
7	Control output 2	
8	Test input	
9	Test input	F3SN-A Safety Light Curtain or F3SH-A Multi-beam Safety Sensor (second set)
10	Control output 2	
11	Reset input	
12	Control output 1	
13	RS-485 (B)	
14	RS-485 (A)	
15	0 V	
16	+24 V	

D1

Terminal No.	Connection	
1	Not used.	
2		
3		
4		
5	Contact such as Safety Limit Switch or Safety Door Switch	First set
6		
7	Contact such as Safety Limit Switch or Safety Door Switch	Second set
8		
9	Contact such as Safety Limit Switch or Safety Door Switch	Second set
10		
11	Contact such as Safety Limit Switch or Safety Door Switch	Second set
12		
13	Not used.	
14		
15		
16		

Relay Output Modules

Terminal No.	Function
11/12	Auxiliary relay output (N.C.)
23/24	Safety relay output (N.O.)
33/34	Safety relay output (N.O.)

Indicator Display, Lighting Patterns, and Meaning for L1/L2/D1 Modules

The ER1 indicator display indicates errors in Modules in the first set, and the ER2 indicator display indicates errors in Modules in the second set.

ER1/ER2 indicator	Meaning	Cause	Remedy
● Lit	Input sync error in input device	The input device contacts are faulty or the input device wiring is incorrect.	Check the input device and wiring.
☀ 1-time flashing	Short-circuit or wiring error between inputs of input device.	The input device wiring is short-circuited.	Check the wiring to the input device.
☀ 2-time flashing	Error in input terminal circuit of input device.	Excessive noise is affecting the F3SX.	Check the noise environment around the F3SX.
		The input device input circuits are faulty.	Replace the F3SX.

Connections

F3SX-NR (Manual Reset) Circuit Example

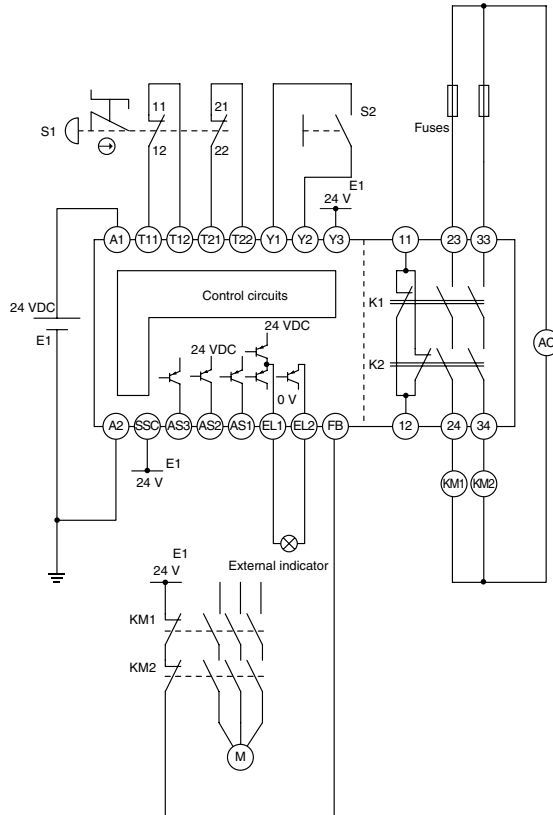

Stop category	IEC60204-1	0
Safety category	EN954-1	4

Timing Chart

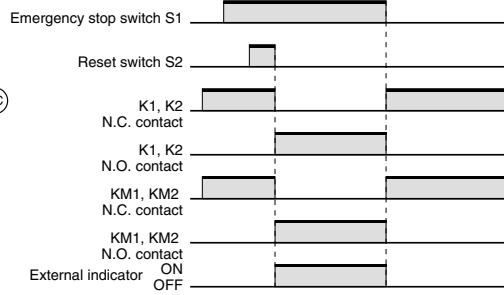

- S1: Emergency stop switch (positive opening mechanism) (A165E, A22E) ⊖
- S2: Reset switch
- KM1, KM2: Magnetic contactor
- M: Three-phase motor
- E1: 24-VDC power supply (S82K)
- External indicator: Filament-type indicator
(When an external indicator is not necessary, connect resistance of 1/4 W, 4.7 kΩ.)

- AS1: Auxiliary control output (synchronized with K1, K2 N.O. contacts)
- AS2: Information trigger
- AS3: Standby output
- SSC: Start command input (Not connected in the above circuit diagram. When this input is not necessary, connect it to terminal A1.)

Note: The above circuit diagram conforms to Category 4.

Safety Networks and Application Controllers

F3SX

F3SX-N-L1D1R Auto-reset Circuit Example

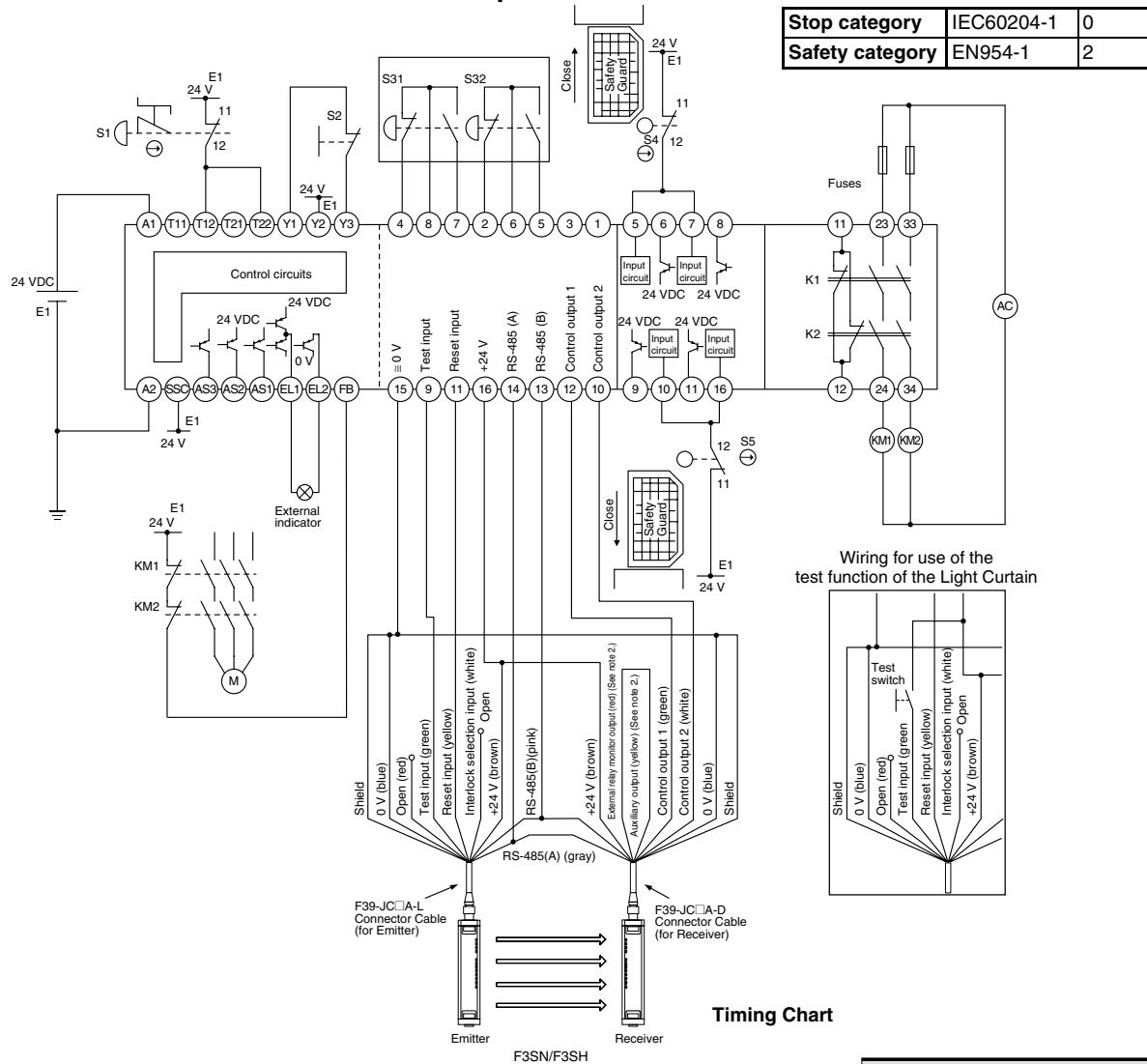

Stop category	IEC60204-1	0
Safety category	EN954-1	2

Wiring for use of the test function of the Light Curtain

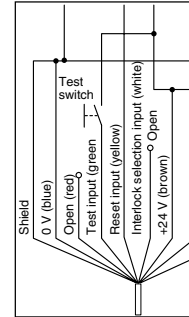

Timing Chart

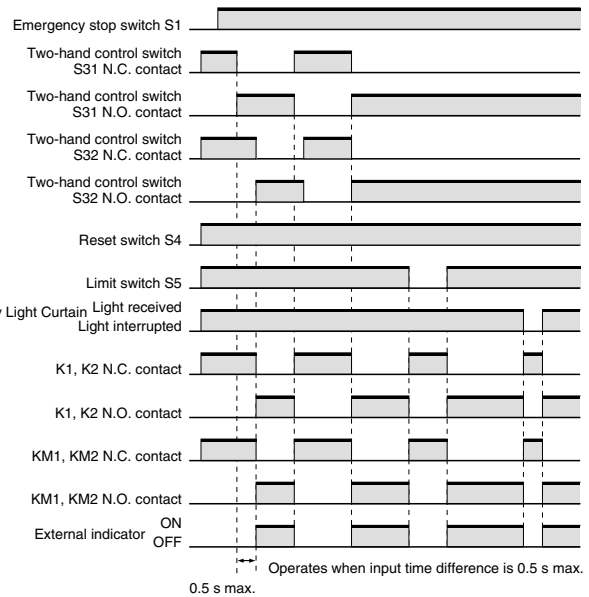

- S1: Emergency stop switch with positive opening mechanism A165E or A22E ⊕
- S2: Reset switch (switch is reset by keeping pressed down for 3 s min.)
- S31, S32: Two-hand control switch
- S4, S5: Safety limit switch with positive opening mechanism (D4D or D4B) ⊕
- KM1, KM2: Magnetic contactor
- M: Three-phase motor
- E1: 24-VDC power supply (S82K)
- External indicator: Filament-type indicator
(When an external indicator is not necessary, connect resistance of 1/4 W, 4.7 kΩ.)
- S6: External test switch
- AS1: Auxiliary control output (synchronized with K1, K2 N.O. contacts)
- AS2: Information trigger
- AS3: Standby output
- SSC: Start command input
(Not connected in the above circuit diagram.
When this input is not necessary, connect it to terminal A1.)
Use switches that can be used with microloads (24 VDC, 5 mA).

- Note 1. The above circuit diagram example conforms to Category 2.
- Note 2. In this connection example, the auxiliary output is set to the standard setting (Dark-ON operation).
To operate using non-standard settings, refer to the catalog or operation manuals for the F3SN/F3SH.
- Note 3. Two-hand Control Switches are available as 1 N.O. and 1 N.C. types, conforming to IEC/EN60947-5-1.
Use compliant products.
Make sure the wiring arrangement satisfies EN574.
Use switches that can be used with microloads (24 VDC, 5 mA).

Safety Networks and Application Controllers

F3SX



Wiring Example: F3SX-ER + F3SX-ED1 + F3SX-ED1 (Manual Reset)

Stop category	IEC60204-1	0
Safety category	EN954-1	4

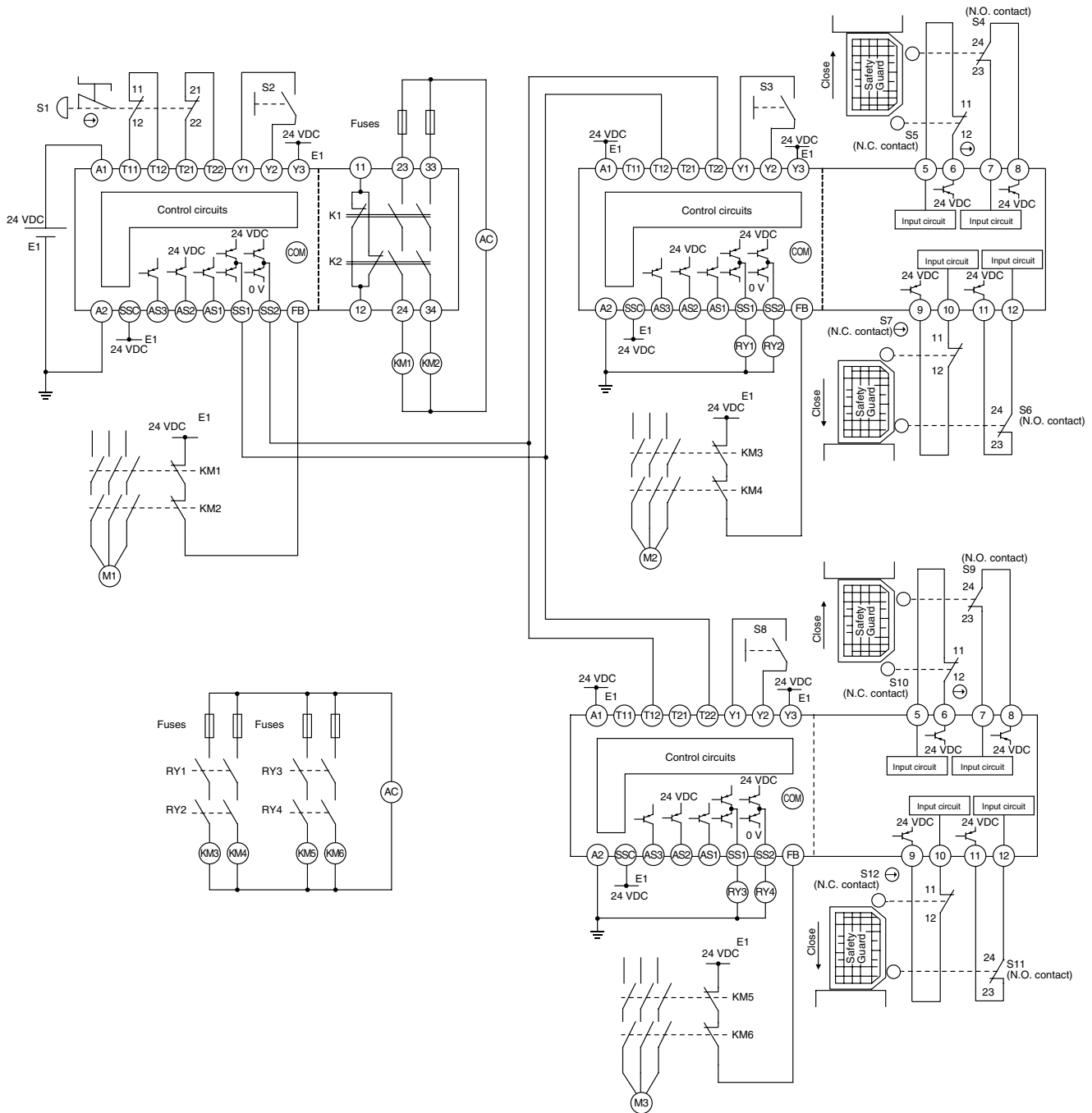

Safety Networks and Application Controllers **F3SX**

- S1: Emergency stop switch with positive opening mechanism (A165E or A22E) ⊖
- S2, S3, S8: Reset switch
- S4, S6, S9, S11: Limit switch
- S5, S7, S10, S12: Safety limit switch with positive opening mechanism (D4D or D4B) ⊖
- KM1 to KM6: Magnetic contactor
- M1 to M3: Three-phase motor
- E1: 24-VDC power supply (S82K)

Note 1. The above circuit diagram example conforms to Category 4.
Note 2. In the above circuit diagram example, the stop category (EN60204-1) is 0.



Dimensions

Note: All dimensions are in millimeters unless otherwise indicated.

■ F3SX Safety Controller

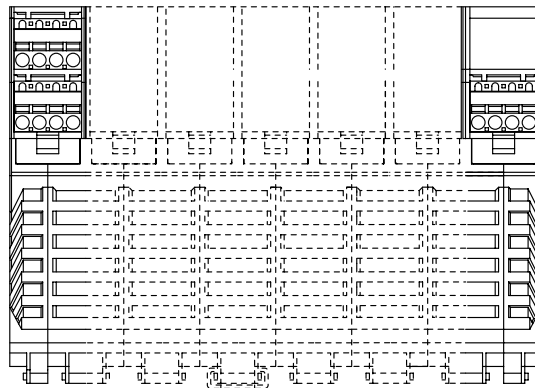
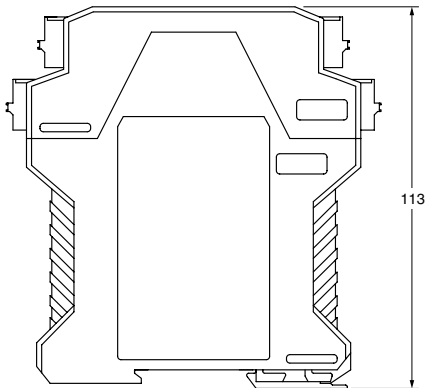
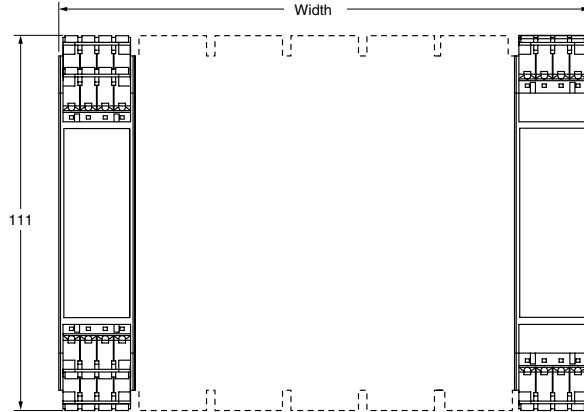

Note: For details on the width, refer to "List of Models" on page EE-102.

Safety Networks
and Application
Controllers

F3SX

F39-TB01 Junction Box for Safety Light Curtain

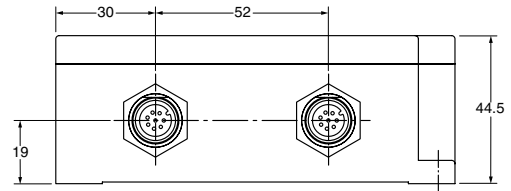
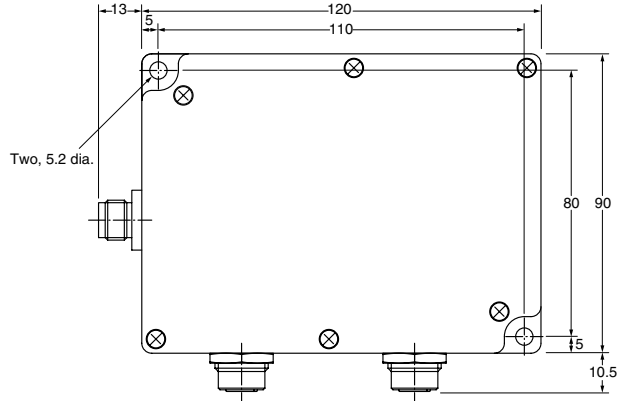
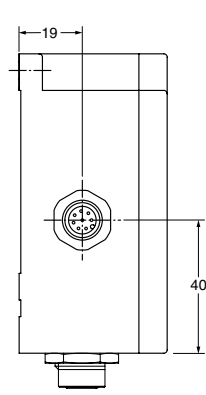

Mounting Hole Dimensions

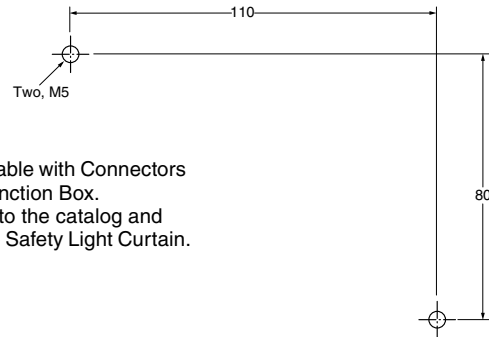

Note: Use F39-JC□□B or F39-JC□□T Cable with Connectors on Both Ends to connect the Junction Box. For details on F39-JC□□B, refer to the catalog and other reference materials for the Safety Light Curtain.

Safety Networks and Application Controllers

F39-JC□□T Cable with Connectors on Both Ends

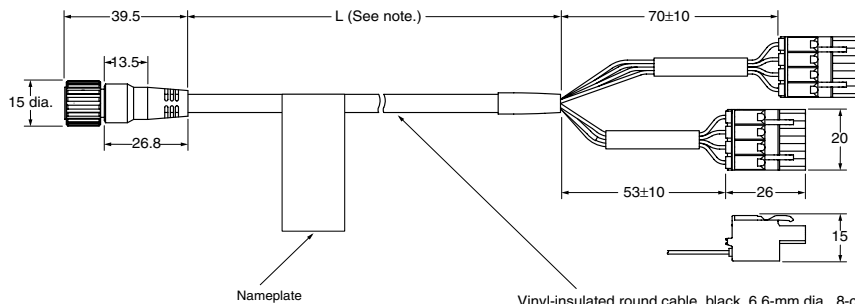

Vinyl-insulated round cable, black, 6.6-mm dia., 8-core (4 sets)
(Conductor cross-section: 0.3 mm²; Insulator diameter: 1.15 mm)
Standard length: L (See note.)

Note: The length depends on the model number, as shown below.

Model	L(mm)
F39-JC1T	1,000 ⁺¹⁵⁰ ₀
F39-JC3T	3,000 ⁺¹⁵⁰ ₀
F39-JC5T	5,000 ⁺³⁰⁰ ₀
F39-JC10T	10,000 ⁺³⁰⁰ ₀

Wire color	Signal name	F3SX terminal No.
Brown	+24 V	1 or 16
Blue/shield	0 V	2 or 15
Gray	RS-485 (A)	3 or 14
Pink	RS-485 (B)	4 or 13
Green	Control output 1	5 or 12
Yellow	Reset output	6 or 11
White	Control output 2	7 or 10
Red	Test input	8 or 9



Safety Precautions

The following information is intended as a guide for selecting the F3SX Safety Controller. Be sure to read the User's Manual for the product (SCHG-705) before use.

Overview

The F3SX is designed for use by authorized personnel who thoroughly understand the installed machinery.

The use of "authorized personnel" in the User's Manual (SCHG-705) refers to personnel qualified and authorized to secure safety across all phases of the safety life cycle from machinery design through, installation, operation, maintenance, and disposal.

The specified installation environment and machinery performance characteristics of the F3SX are applicable under correct usage conditions. Have a related organization perform risk assessment before selecting, installing, or setting the F3SX.

Be sure to thoroughly read and understand the User's Manual for the product (SCHG-705) before use and always use the product correctly according to the manual.

Regulations and Standards

"Type Approval" specified in Chapter 44.2 of the Industrial Safety and Health Law in Japan does not apply to independent Controllers. This law applies to systems incorporated with the F3SX Controllers. Therefore, when using the F3SX Controllers in Japan as "safety devices for presses or shearing machines" as specified in Chapter 42 of the same law, apply for approval as a system.

The F3SX is electro-sensitive protective equipment (ESPE) in accordance with European Union (EU) Machinery Directive Annex IV, B, Safety Components, Item 1, Item 2.

The F3SX received the following approvals from TÜV-PS.

● EU Regulations

- Machinery Directive: Directive 98/37/EC
- Low Voltage Directive: Directive 73/23/EEC
- EMC Directive: Directive 89/336/EEC

● European Standards

- EN61508 (SIL 1-3), EN954-1 (Category 4, 3, 2, 1, B), EN61496-1 (TYPE 4 ESPE), EN50178, EN55011, EN60204-1, EN61000-6-2, EN61000-6-4, EN1760, EN574 (Type III C), EN1088

● International Standards

- IEC61508 (SIL 1-3), IEC61496-1 (Type 4 ESPE), IEC60204-1
- The F3SX received the following approvals from the Third Party Assessment Body UL:
- Certificate of UL listing for US and Canadian safety standards: UL508, UL1998, UL61496-1 (Type 4 ESPE), CSA C22.2 No. 14, CSA C22.2 No.0.8

⚠ WARNING

Install the reset switch in a location from which the entire hazardous area is visible and where the switch cannot be operated from within the hazardous area.

- Connect control devices that are suitable for the required safety functions. Using unsuitable external devices may result in the F3SX not being capable of performing safety functions fully.
- The DC Power Supply Unit must satisfy all of the following conditions for the F3SX to meet EN60204-1, IEC61496-1, and UL508 standards.
 - The power supply voltage is within the rating (24 VDC ± 10%).
 - The power supply is used to supply the F3SX and its connected Sensors only, and is not connected to any other devices or equipment. When connecting multiple devices, make sure the total rated current is not exceeded.
 - The power supply conforms to the EMC Directive (industrial environment).

- The power supply uses double or reinforced insulation between the primary and secondary circuits.
- The power supply automatically resets overcurrent protection characteristics (voltage drop).
- The power supply maintains an output holding time of at least 20 ms.
- The power supply must have output characteristics of Class 2 Circuit or Limited Voltage-Current Circuit as defined in UL508.
- The power supply must conform to regulatory requirements and standards regarding EMC and electrical equipment safety of the country where the F3SX is installed.
 - Example: The EMC Directive (industrial environment) and the Low Voltage Directive in EU.

When using a commercially available switching regulator, make sure FG (frame ground terminal) is connected. Faulty operation caused by switching noise may result if the terminal is not connected.

Do not connect a DC or AC power supply output that exceeds the rated value to the power supply input of the F3SX.

Connect a fuse serially to the output contact of the relay output.

Do not use a load that exceeds the switching capacity. Doing so may result in damage to the output circuits and the F3SX may not be capable of turning OFF.

Take measures to prevent common malfunctions that would disable all redundant safety circuits at the same time.

Do not use the F3SX's PLC communications functions to configure a safety system. Doing so may result in serious injury due to faulty wiring or PLC malfunction.

Do not attempt to disassemble, repair, or modify the F3SX. Otherwise, the F3SX may not be capable of performing its safety functions.

Wire the I/O terminals correctly. Incorrect wiring may result in electric shock or the safety functions may be damaged.

Do not use the auxiliary outputs to configure a safety system. Using the auxiliary outputs as safety outputs may result in serious injury if the F3SX or peripheral devices malfunction.

Do not connect input devices to the auxiliary input terminal (start command input) to configure a safety system. Doing so may result in serious injury if the F3SX or peripheral devices malfunction.

⚠ CAUTION

The applicable safety category is determined from the whole safety control system. Consultation with a third party assessment body is recommended to make sure that the whole safety control system meets requirements.

The service life greatly depends on factors such as the switching conditions and load. Be sure to test the F3SX under actual application conditions, and make sure that the number of switching operations is within the permissible range.

Use the F3SX within a protective structure that complies with IP54 or higher.

Secure the F3SX to the DIN track using Mounting Brackets if the DIN track is short or if securing is otherwise required. Not doing so may result in the F3SX falling off the DIN track due to vibration.

Provide a space of at least 5 mm beside and at least 50 mm above and below the F3SX for ventilation.

Terminology

IEC61508: 1998 (EN61508: 2001)

This standard specifies detailed provisions for the procedures to be followed (including design and evaluation methods) covering all phases of the safety life cycle from design through installation, maintenance, and disposal when a product has safety functions that use electrical, electronic, or programmable systems.

DC Solid-state Safety Output Waveform

In the F3SX, the output periodically turns OFF for a short time to check that the function for turning OFF output is operating normally. If the output signal turns OFF during this time the output circuit is determined to be operating normally. Conversely, if the output does not turn OFF, an output circuit or wiring error is detected, and the Controller is put in lockout status. Set the input response time of connected devices such that the devices connected to terminals SS1 and SS2 do not malfunction due to the OFF pulse signal.

SIL (Safety Integrity Level)

SIL refers to a numeric value that indicates the safety integrity requirements of the safety system in the same way as they were previously indicated by EN954-1 Safety Categories B, and 1 through 4. The level is obtained by calculating the ratio of dangerous malfunctions that can occur and assigning a level that corresponds to the frequency of use. This Controller is SIL3, which indicates a safety level equivalent to EN954-1 Safety Category 4.

Diagnostic Functions

Intersystem Synchronous Monitoring

The time difference in the rise time of inputs between systems (between channels 1 and 2) is monitored. This prevents safety equipment from being disabled.

Intersystem Short-circuit Monitoring

Short-circuits of inputs between systems (between channels 1 and 2) are monitored. This allows detection of damage to safety equipment. If a short-circuit occurs, the Controller is locked out, and the OFF status is maintained. (Fuse replacement is not required.)

Control Functions

Monitoring Feedback Timing (FB)

The N.C. contact of the external relay that controls the source of danger in the machine is input to the F3SX as a feedback signal, thereby detecting welding contacts and other operating faults, and can also monitor whether the feedback signal is returned within a fixed time (factory setting: 500 ms).

When not using this function, use the Function Setup Software (F3SX-CD100) for the F3SX to adjust settings accordingly.

Standby Output (AS3 Terminal)

The standby output is output after the F3SX CPU Unit is initialized and I/O control can be performed normally. Use this output as part of the operation standby signals for the entire system.

The standby output is not a safety output. Do not use the standby output to configure safety systems. Doing so may result in serious injury if a malfunction occurs.



Ready Output (AS2 Terminal: E Modules)

The ready output is output when the F3SX is in a standby state and all the safety inputs are ON.

Information Trigger (AS2 Terminal: N Modules)

The information trigger is output when damage or a timeout occurs during Controller diagnosis or monitoring. The trigger signal can be used as a command request signal to a host (e.g., Programmable Controller or personal computer).

The information trigger output is not a safety output. Do not use the information trigger to configure safety systems. Doing so may result in serious injury if a malfunction occurs.



Start Command Input (SSC Terminal)

The start command input is used to operate a safety relay when it receives a start command from the machine in addition to an input condition from the safety device. (If the SSC terminal is not required, connect it to the 24-VDC terminal.)

Do not connect the start command input to an input device, or otherwise use it to configure safety systems. Doing so may result in serious injury if a malfunction occurs.



■ Precautions for Correct Use

Do not use the F3SX in atmospheres or environments that exceed product ratings.

ALL DIMENSIONS SHOWN ARE IN MILLIMETERS.

To convert millimeters into inches, multiply by 0.03937. To convert grams into ounces, multiply by 0.03527.

In the interest of product improvement, specifications are subject to change without notice.

OMRON AUTOMATION AND SAFETY • THE AMERICAS HEADQUARTERS • Chicago, IL USA • 847.843.7900 • 800.556.6766 • www.omron247.com

OMRON CANADA, INC. • HEAD OFFICE

Toronto, ON, Canada • 416.286.6465 • 866.986.6766 • www.omron247.com

OMRON ELECTRONICS DE MEXICO • HEAD OFFICE

México DF • 52.55.59.01.43.00 • 01-800-226-6766 • mela@omron.com

OMRON ELECTRONICS DE MEXICO • SALES OFFICE

Apodaca, N.L. • 52.81.11.56.99.20 • 01-800-226-6766 • mela@omron.com

OMRON ELETRÔNICA DO BRASIL LTDA • HEAD OFFICE

São Paulo, SP, Brasil • 55.11.2101.6300 • www.omron.com.br

OMRON ARGENTINA • SALES OFFICE

Cono Sur • 54.11.4783.5300

OMRON CHILE • SALES OFFICE

Santiago • 56.9.9917.3920

OTHER OMRON LATIN AMERICA SALES

54.11.4783.5300

OMRON EUROPE B.V. • Wegalaan 67-69, NL-2132 JD, Hoofddorp, The Netherlands. • +31 (0) 23 568 13 00 • www.industrial.omron.eu

Authorized Distributor:

Automation Control Systems

- Machine Automation Controllers (MAC) • Programmable Controllers (PLC)
- Operator interfaces (HMI) • Distributed I/O • Software

Drives & Motion Controls

- Servo & AC Drives • Motion Controllers & Encoders

Temperature & Process Controllers

- Single and Multi-loop Controllers

Sensors & Vision

- Proximity Sensors • Photoelectric Sensors • Fiber-Optic Sensors
- Amplified Photomicrosensors • Measurement Sensors
- Ultrasonic Sensors • Vision Sensors

Industrial Components

- RFID/Code Readers • Relays • Pushbuttons & Indicators
- Limit and Basic Switches • Timers • Counters • Metering Devices
- Power Supplies

Safety

- Laser Scanners • Safety Mats • Edges and Bumpers • Programmable Safety Controllers • Light Curtains • Safety Relays • Safety Interlock Switches