

# BGA619

Silicon Germanium

High IP3 PCS Low Noise Amplifier

Wireless  
Silicon Discretes



Never stop thinking.

**Edition 2004-04-29**

**Published by Infineon Technologies AG,  
St.-Martin-Strasse 53,  
D-81541 München**

**© Infineon Technologies AG 2004**

**All Rights Reserved.**

**Attention please!**

The information herein is given to describe certain components and shall not be considered as warranted characteristics.

Terms of delivery and rights to technical change reserved.

We hereby disclaim any and all warranties, including but not limited to warranties of non-infringement, regarding circuits, descriptions and charts stated herein.

Infineon Technologies is an approved CECC manufacturer.

**Information**

For further information on technology, delivery terms and conditions and prices please contact your nearest Infineon Technologies Office in Germany or our Infineon Technologies Representatives worldwide (see address list).

**Warnings**

Due to technical requirements components may contain dangerous substances. For information on the types in question please contact your nearest Infineon Technologies Office.

Infineon Technologies Components may only be used in life-support devices or systems with the express written approval of Infineon Technologies, if a failure of such components can reasonably be expected to cause the failure of that life-support device or system, or to affect the safety or effectiveness of that device or system. Life support devices or systems are intended to be implanted in the human body, or to support and/or maintain and sustain and/or protect human life. If they fail, it is reasonable to assume that the health of the user or other persons may

---

**BGA619****Data Sheet****Revision History:        April 2004**

---

Previous Version:        February 2004

---

Page	Subjects (major changes since last revision)
4	Marking corrected

---

For questions on technology, delivery and prices please contact the Infineon Technologies Offices in Germany or the Infineon Technologies Companies and Representatives worldwide: see our webpage at <http://www.infineon.com>

# Silicon Germanium High IP3 PCS Low Noise Amplifier

**BGA619**

## Features

- B7HF silicon germanium technology
- Tiny P-TSLP-7-1 leadless package
- RF output-port internally pre-matched to 50Ω
- Low external component count
- Three gain steps
- Power off function
- High IP3 in all modes
- Typical supply voltage: 2.78 V

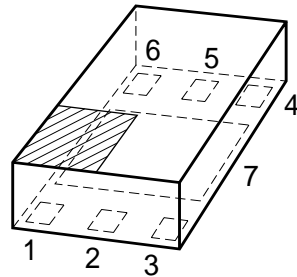

## Applications

- 1.9 GHz PCS wireless frontends (CDMA2000)

P-TSLP-7-1

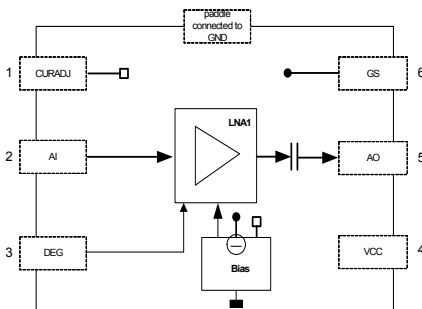

## Description

The BGA619 is a high IP3 PCS low noise amplifier, designed for 1.9GHz applications.

Internal biasing provides stable current conditions for all gain modes over temperature range.

Using the pin GS the BGA619 can be switched between three gain modes (HIGH, MID & LOW) and the OFF mode.

**ESD:** Electrostatic discharge sensitive device, observe handling precaution!

Type	Package	Marking	Chip
BGA619	P-TSLP-7-1	BT	T1544

**Pin Definition and Function**

Pin No.	Symbol	Function
1	CURADJ	Current adjust LNA
2	AI	LNA input
3	DEG	RF ground
4	VCC	Supply voltage LNA
5	AO	LNA output
6	GS	Gain step control
7	GND	Ground

**Maximum Rating**

Parameter	Symbol	Limit value	Unit
Voltage at pin VCC	VCC	-0.3 ... 3.6	V
Voltage at pin AI (LNA input)	AI	-0.3 (min.)	V
Voltage at pin AO (LNA output)	AO	-0.3 ... $V_{VCC}+0.3$ 3.6 (max.)	V
External resistor	$R_{CURADJ}$	6 (min.)	$k\Omega$
Current into VCC	ICC	11	mA
Junction temperature	$T_j$	150	$^{\circ}C$
Ambient temperature range	$T_A$	-35... 85	$^{\circ}C$
Storage temperature range	$T_{STG}$	-40 ... 150	$^{\circ}C$
ESD capability (HBM: JESD22A-114) RF pin AI all other pins	$V_{ESD}$	<500 1000	V

Notes:

All Voltages refer to GND-Node

**Electrical Characteristics**

$T_A=25^{\circ}\text{C}$ ;  $V_{CC}=2.78\text{V}$ ,  $R_{LNA\_Curadj} = 15\text{k}\Omega$ , frequency=1.96GHz, HIGH: GS=2.3V, MID: GS=1.7V, LOW: GS=1.0V, unless otherwise noted; measured on BGA619 Appl. Board V1.0 including PCB losses

Parameter	Symbol	GS mode	min.	typ.	max.	Unit
Supply current	$I_{CC}$	HIGH		6.5		mA
		MID		4.5		
		LOW		2.9		
		OFF		280		
Power gain	$S_{21}$	HIGH		14.9		dB
		MID		2.2		
		LOW		-9.5		
Noise figure ( $Z_s = 50\Omega$ )	$NF$	HIGH		1.5		dB
		MID		8		
		LOW		16		
Input Return Loss	$S_{11}$	HIGH		10.5		dB
		MID		8.5		
		LOW		12.5		
Output Return Loss	$S_{22}$	HIGH		11.5		dB
		MID		13		
		LOW		13		
Reverse isolation	$S_{12}$	HIGH		25		dB
		MID		21		
		LOW		23		
Power gain settling time (within 1dB of the final gain)	$t_s$	ALL		70		$\mu\text{s}$
3rd order input intercept point f1= 1950MHz, f2= f1 +/-1MHz P(f1,f2)= -30dBm P(f1,f2)= -27dBm P(f1,f2)= -15dBm	$IIP_3$	HIGH		7		dBm
		MID		6.5		
		LOW		15		
		OFF				
Gain step input voltage	$GS$	HIGH	2.2		2.4	V
		MID	1.6		1.8	
		LOW	0.9		1.1	
		OFF	0.0		0.3	
Gain control current	$I_{GS}$	HIGH OFF			95 -55	$\mu\text{A}$

Typical measurement results HIGH Gain Mode;  $T_A = 25^\circ\text{C}$

**Gain**  $|S_{21}| = f(f)$

$V_{CC} = 2.78\text{V}$ ,  $I_{CC} = 6.5\text{mA}$

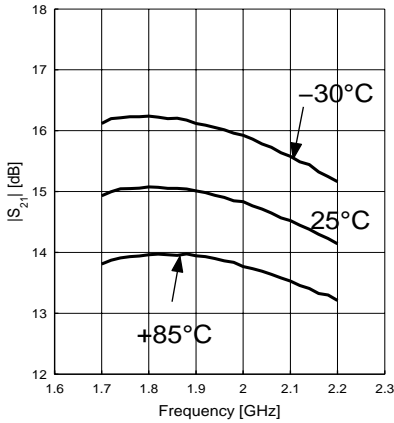

**Noise Figure**  $NF = f(f)$

$V_{CC} = 2.78\text{V}$ ,  $I_{CC} = 6.5\text{mA}$ , Gain = 14.9dB

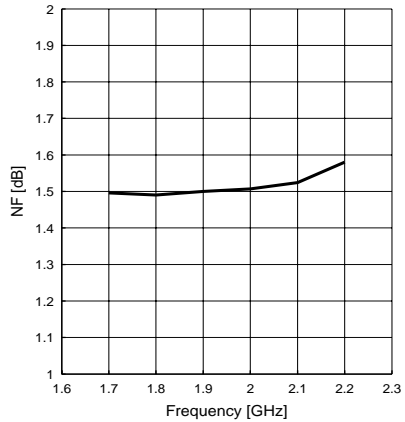

**Reverse Isolation**  $|S_{12}| = f(f)$

$V_{CC} = 2.78\text{V}$ ,  $I_{CC} = 6.5\text{mA}$

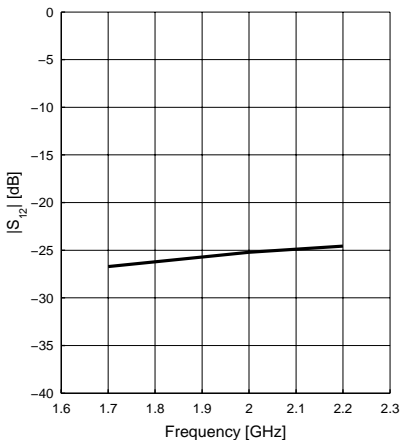

**Matching**  $|S_{11}|, |S_{22}| = f(f)$

$V_{CC} = 2.78\text{V}$ ,  $I_{CC} = 6.5\text{mA}$

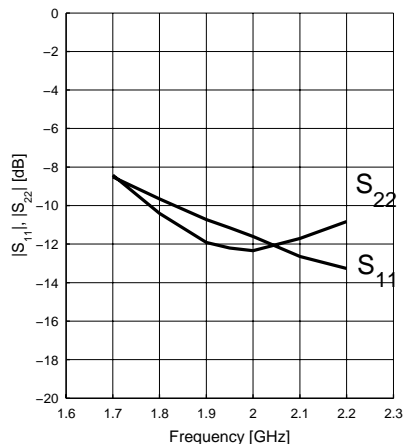

Typical measurement results MID Gain Mode;  $T_A = 25^\circ\text{C}$

**Gain**  $|S_{21}| = f(f)$

$V_{CC} = 2.78\text{V}, I_{CC} = 4.5\text{mA}$

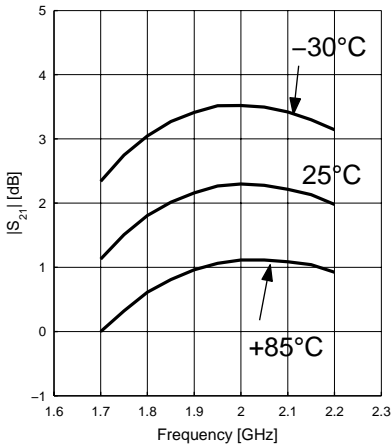

**Noise Figure**  $NF = f(f)$

$V_{CC} = 2.78\text{V}, I_{CC} = 4.5\text{mA}, \text{Gain} = 2.2\text{dB}$

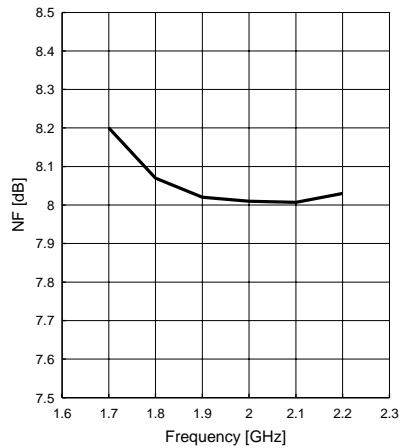

**Reverse Isolation**  $|S_{12}| = f(f)$

$V_{CC} = 2.78\text{V}, I_{CC} = 4.5\text{mA}$

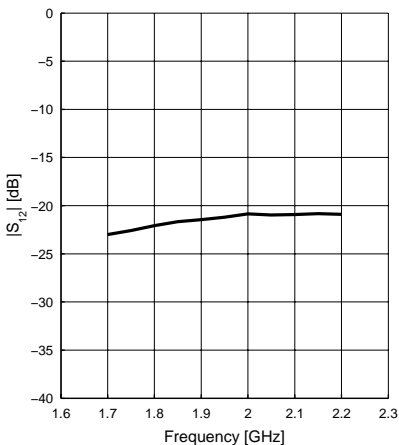

**Matching**  $|S_{11}|, |S_{22}| = f(f)$

$V_{CC} = 2.78\text{V}, I_{CC} = 4.5\text{mA}$

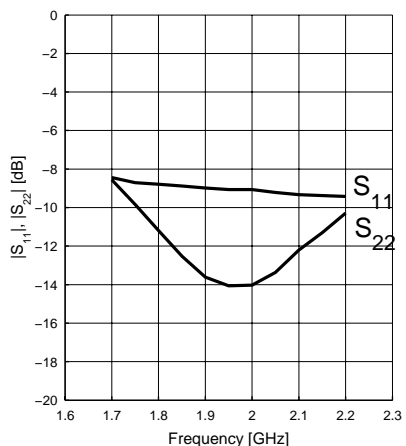



Typical measurement results LOW Gain Mode;  $T_A = 25^\circ\text{C}$

**Gain**  $|S_{21}| = f(f)$

$V_{CC} = 2.78\text{V}$ ,  $I_{CC} = 2.9\text{mA}$

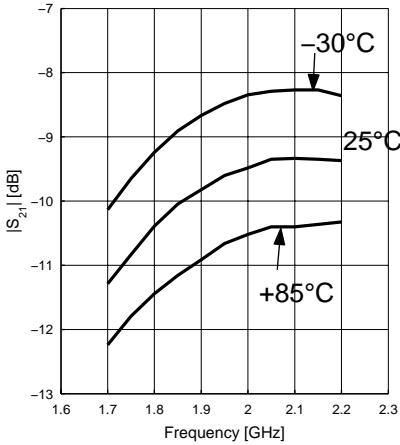

**Noise Figure**  $NF = f(f)$

$V_{CC} = 2.78\text{V}$ ,  $I_{CC} = 2.9\text{mA}$ , Gain = -9.5dB

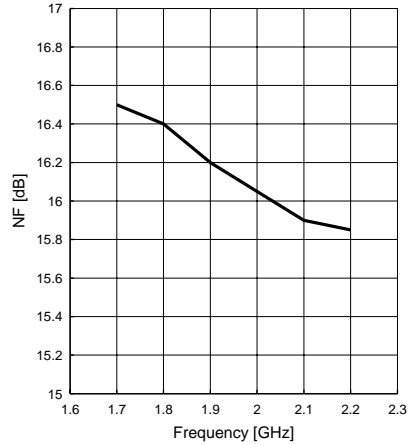

**Reverse Isolation**  $|S_{12}| = f(f)$

$V_{CC} = 2.78\text{V}$ ,  $I_{CC} = 2.9\text{mA}$

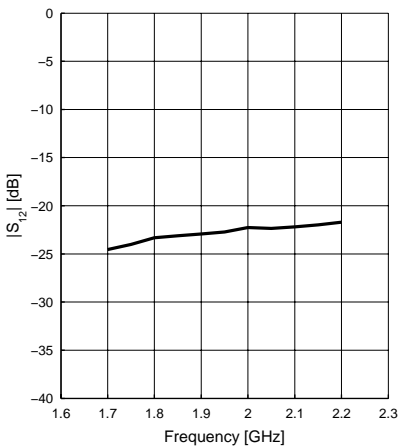

**Matching**  $|S_{11}|, |S_{22}| = f(f)$

$V_{CC} = 2.78\text{V}$ ,  $I_{CC} = 2.9\text{mA}$

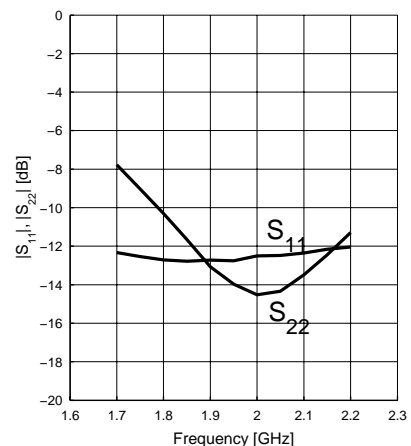

## Typical measurement results 3rd Order Intercept Point

### High Gain Mode

**Intercept Point 3rd O.**  $IIP3 = f(T_A)$

$V_{CC} = 2.78V$ ,  $I_{CC} = 6.5mA$ , Gain = 14.9dB

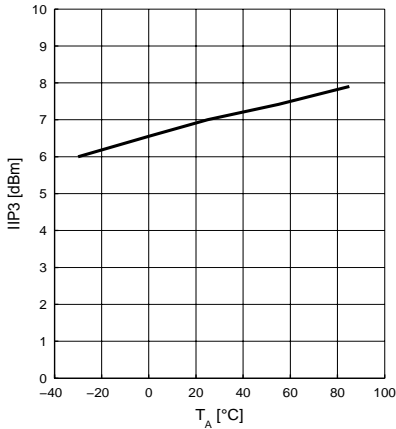

### Mid Gain Mode

**Intercept Point 3rd O.**  $IIP3 = f(T_A)$

$V_{CC} = 2.78V$ ,  $I_{CC} = 4.5mA$ , Gain = 2.2dB

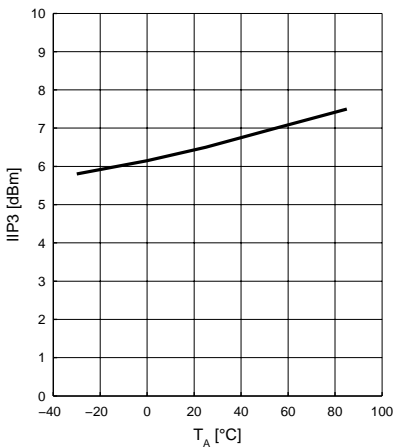

### Low Gain Mode

**Intercept Point 3rd O.**  $IIP3 = f(T_A)$

$V_{CC} = 2.78V$ ,  $I_{CC} = 2.9mA$ , Gain = -9.5dB

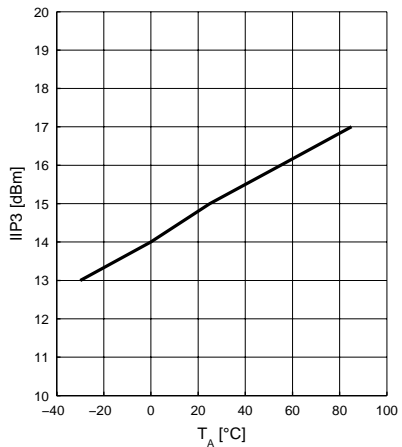

**Typical measurement results Supply Current vs.Temp & Supply (2.7..2.78..2.86V)**

**HIGH Gain Mode**

**Supply current vs. Temp.**  $I_{CC} = f(T_A, V_{CC})$

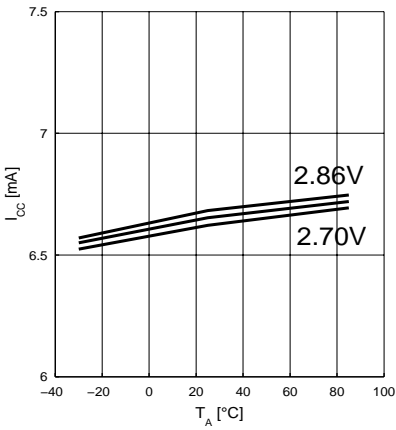

**MID Gain Mode**

**Supply current vs. Temp.**  $I_{CC} = f(T_A, V_{CC})$

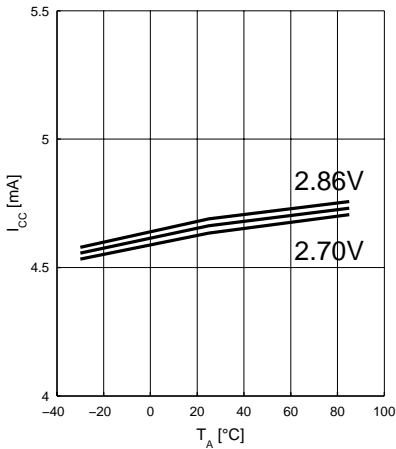

**LOW Gain Mode**

**Supply current vs. Temp.**  $I_{CC} = f(T_A, V_{CC})$

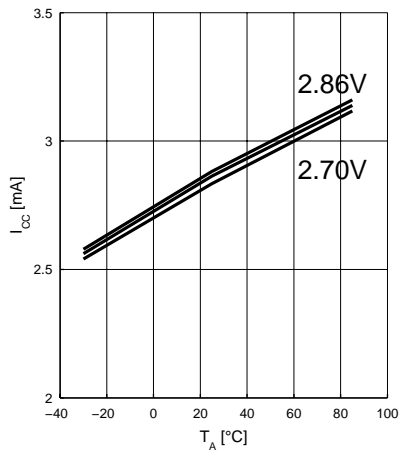

**Typical measurement results Noise Figure**

**HIGH Gain Mode**

**Noise Figure**  $NF = f(T_A)$

$V_{CC} = 2.78V, I_{CC} = 6.5mA, Gain = 14.9dB$

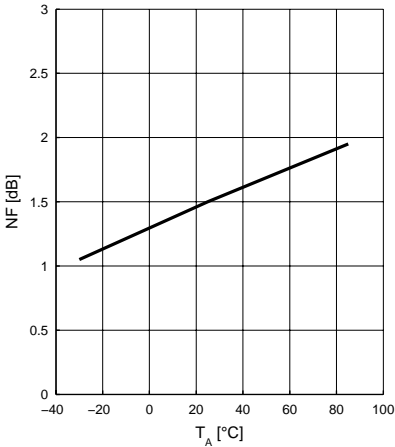

**MID Gain Mode**

**Noise Figure**  $NF = f(T_A)$

$V_{CC} = 2.78V, I_{CC} = 4.5mA, Gain = 2.2dB$

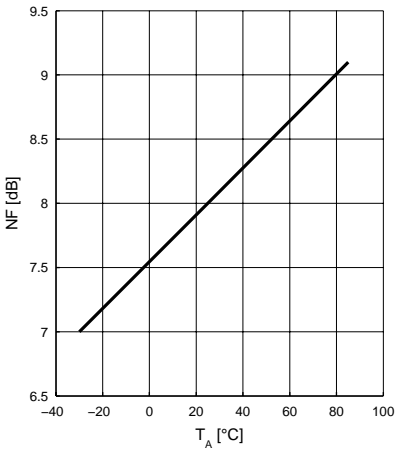

**LOW Gain Mode**

**Noise Figure**  $NF = f(T_A)$

$V_{CC} = 2.78V, I_{CC} = 2.9mA, Gain = -9.5dB$

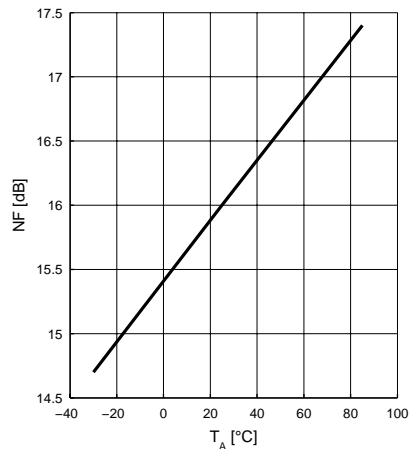

### PCB Board Configuration

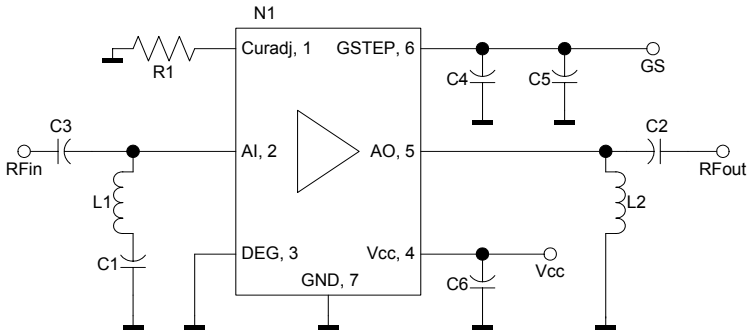

### Bill of Materials

Name	Value	Package	Manufacturer	Function
R1	15 kΩ	0402	various	bias resistance
L1	3.3 nH	0402	various	LF trap & input matching
L2	4.7 nH	0402	various	output matching
C1	10 nF	0402	various	LF trap
C2	10 pF	0402	various	DC block
C3	10 pF	0402	various	DC block
C4	10p	0402	various	control voltage filtering - OPTIONAL
C5	1 nF	0402	various	control voltage filtering - OPTIONAL
C6	1 nF	0402		supply filtering
N1	BGA619	P-TSLP-7-1	Infineon	SiGe LNA

