

Tous droits strictement reserves. Reproduction ou communication a des tiers interdite sous quelque forme que ce soit sans autorisation ecrite du proprietaire. Propriete de c FCI. Droits de reproduction FCI.

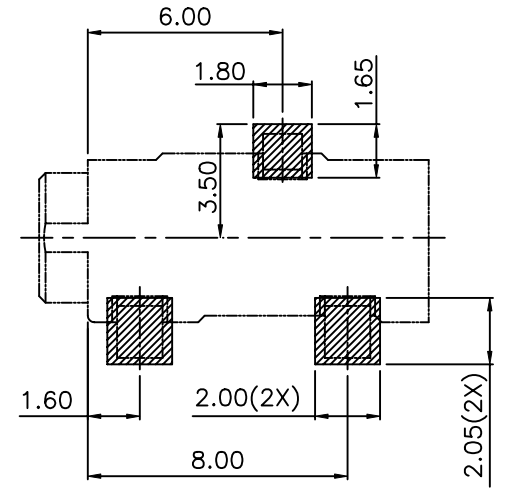

All rights strictly reserved. Reproduction or issue to third parties in any form whatever is not permitted without written authority from the proprietor. Property of Fci. Copyright FCI.

PART NUMBER
10103332-AXPLF

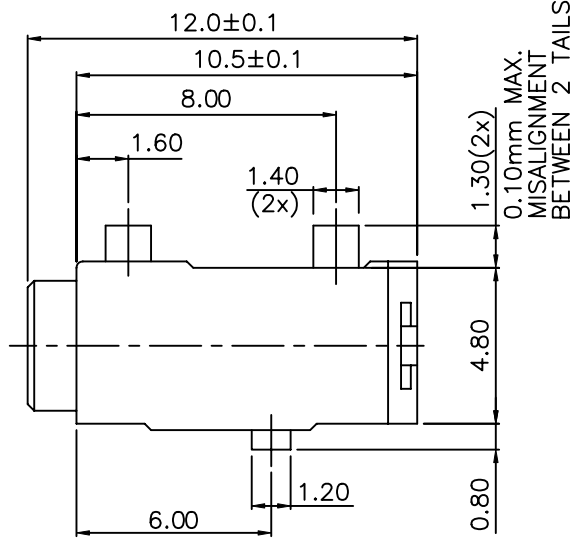

RECOMMENDED PCB LAYOUT
GENERAL TOLERANCE ±0.05mm(BOTTOM VIEW)

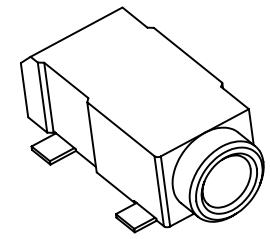
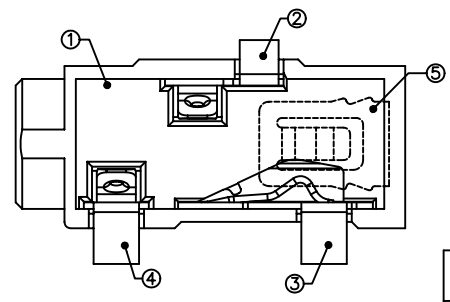
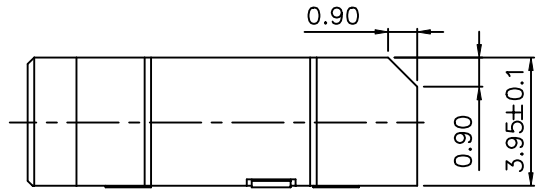
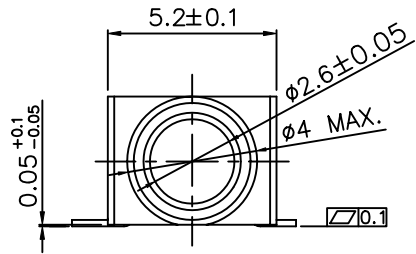

mat'l. code				tolerances unless otherwise specified			CUSTOMER COPY		FCI		www.fciconnect.com	
ltr	ecn no	dr	date	linear	.X ±0.30		projection	title				
A	T10-0044	WL	03/09/10		.XX ±0.20			ø2.5 PHONE JACK				
B	T10-0087	WL	06/29/10		.XXX ±0.10			product family				
C	T10-0133	WL	08/12/10	angles	±2°		MM		size		code	
				dr	WENDY CHEN	07/30/09	scale		A4		TWN	
				enr	WENDY CHEN	07/30/09			10103332		sheet	
				chr	GARY HSIEH	07/30/09					1 of 2	
				appd	JOSEPH HSIA	07/30/09						
sheet	revision	C	C									
index	sheet	1	2									



NOTES :

1. MATERIALS :
 - a. ITEM 1: HOUSING : THERMOPLASTIC UL94 V-0, COLOR; BLACK.
 - b. ITEM 2,3,4 : CONTACT : COPPER ALLOY.
 - c. ITEM 5 : SPRING : STAINLESS STEEL.
2. PLATING :
CONTACT AND SOLDER AREA: SELECTIVE GOLD PLATED OVERALL,
AND 50u" MIN. NICKEL UNDER PLATED.
3. PRODUCT SPECIFICATION: GS-12-637.
4. PACKING SPECIFICATION: GS-14-1442.
5. THIS PRODUCT MEETS THE EUROPEAN UNION DIRECTIVE AS DESCRIBED IN GS-22-008.
6. THE HOUSING WILL WITHSTAND EXPOSURE TO 260°C PEAK TEMPERATURE FOR 10 SECONDS IN A CONVECTION, IR OR VAPER PHASE REFLOW OVEN.
7. PART NUMBER DESCRIPTION:

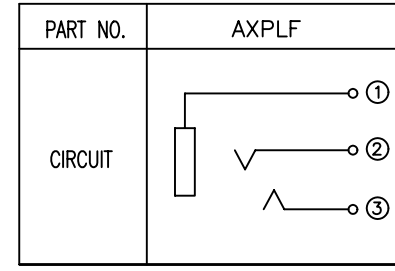
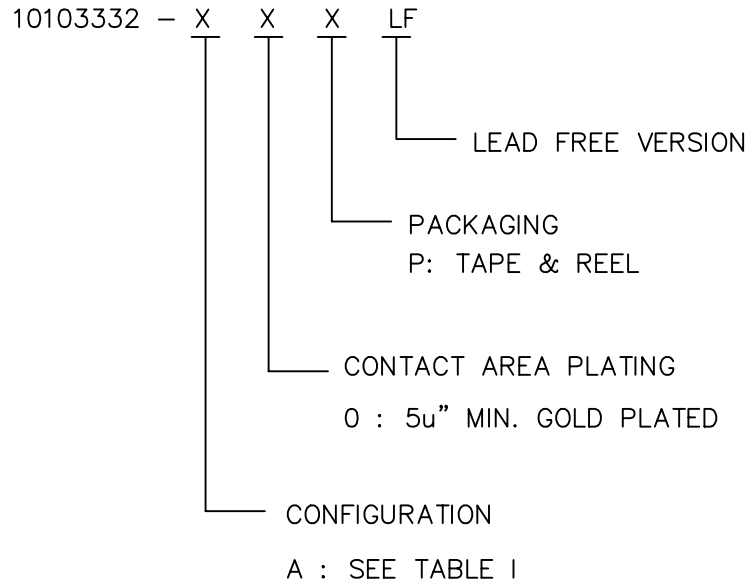

TABLE I

mat'l. code				tolerances unless otherwise specified				CUSTOMER COPY		FCI		www.fciconnect.com		
ltr	ecn no	dr	date	linear	.X ±0.30				projection	title				
C					.XX ±0.20						ø2.5 PHONE JACK			
					angles	.XXX ±0.10					product family		code	
						±2"				size		TWN		
				dr	WENDY CHEN	07/30/09	MM		size		sheet			
				enr	WENDY CHEN	07/30/09	←		10103332		2 of			
				chr	GARY HSIEH	07/30/09	→		A4					
				appd	JOSEPH HSIA	07/30/09	scale							
sheet	revision													
index	sheet													