

THIS DRAWING IS UNPUBLISHED. RELEASED FOR PUBLICATION  
 © COPYRIGHT BY TYCO ELECTRONICS CORPORATION. ALL RIGHTS RESERVED.

LOC		DIST		REVISIONS			
P	LTR	DESCRIPTION	DATE	DWN	APVD		
A		DRAWING RELEASED PER ECR-11-017294	22AUG2011	JvdH	TdB		
B		REVISED PER ECR-15-016753	24NOV2015	FL	FY		

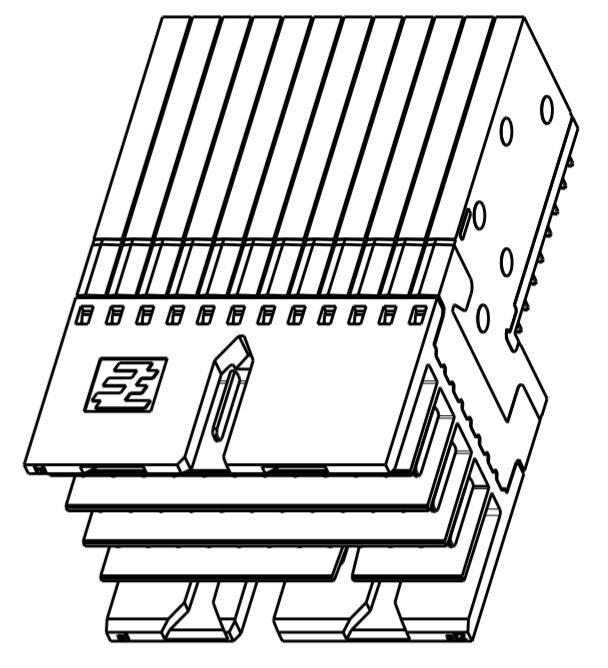

SCALE 3:1

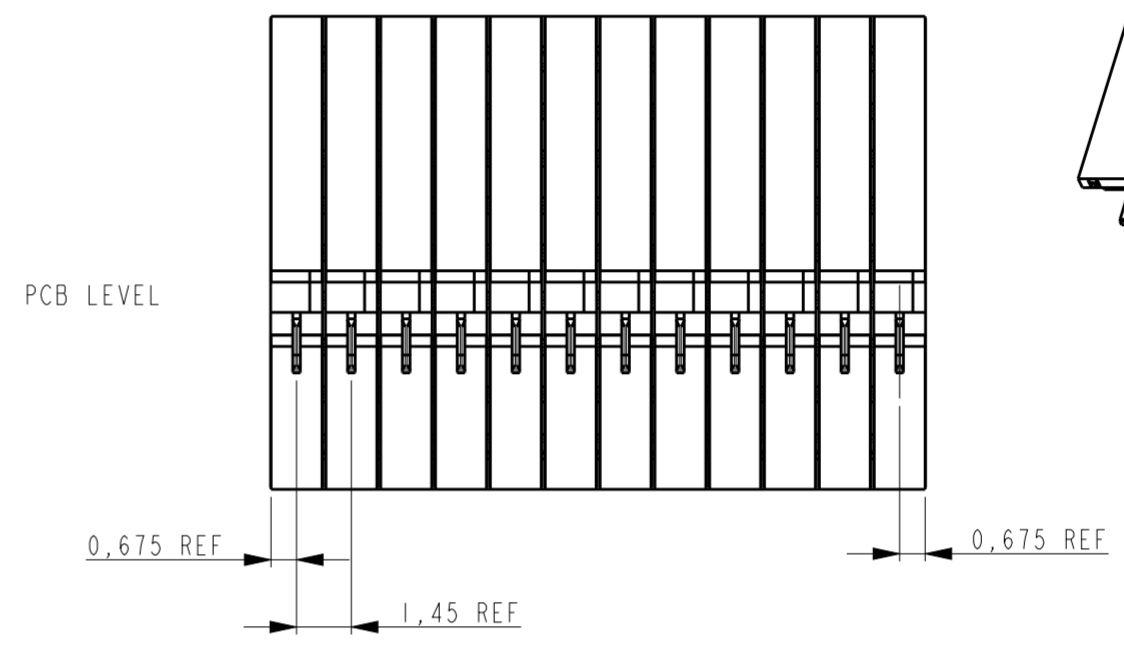
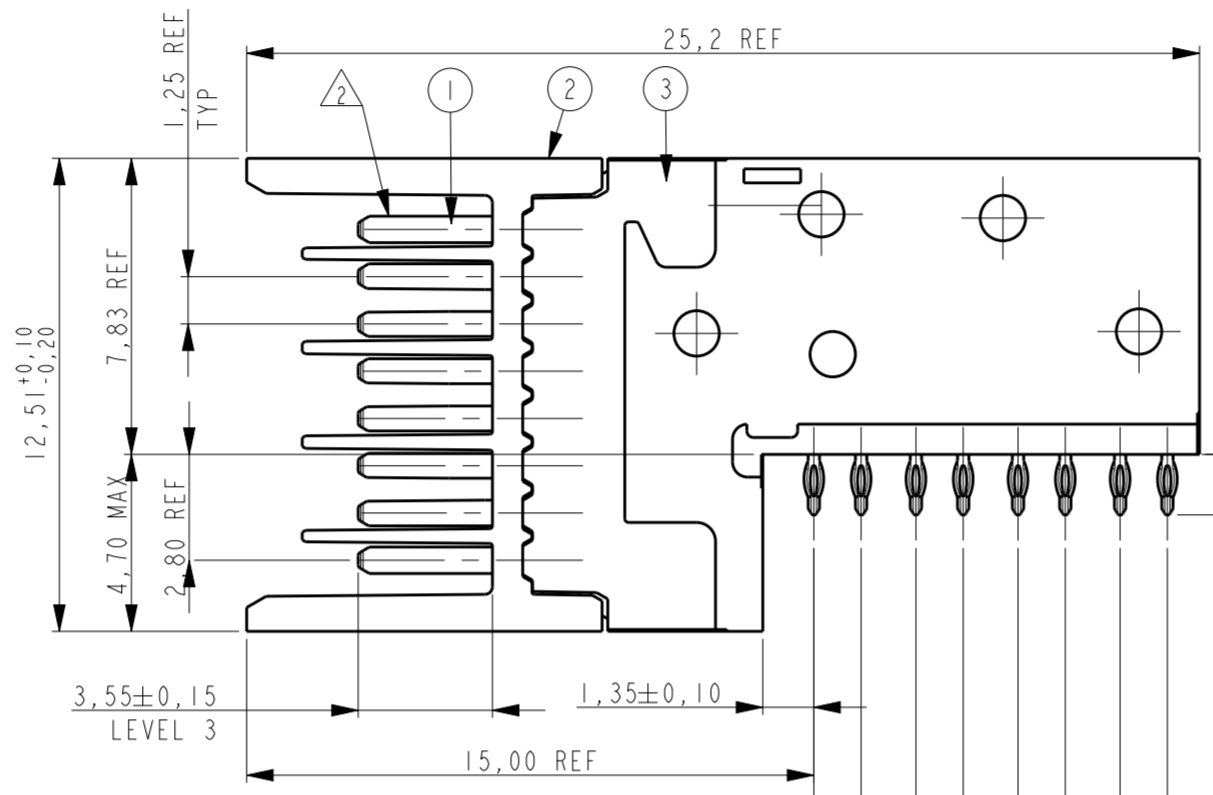
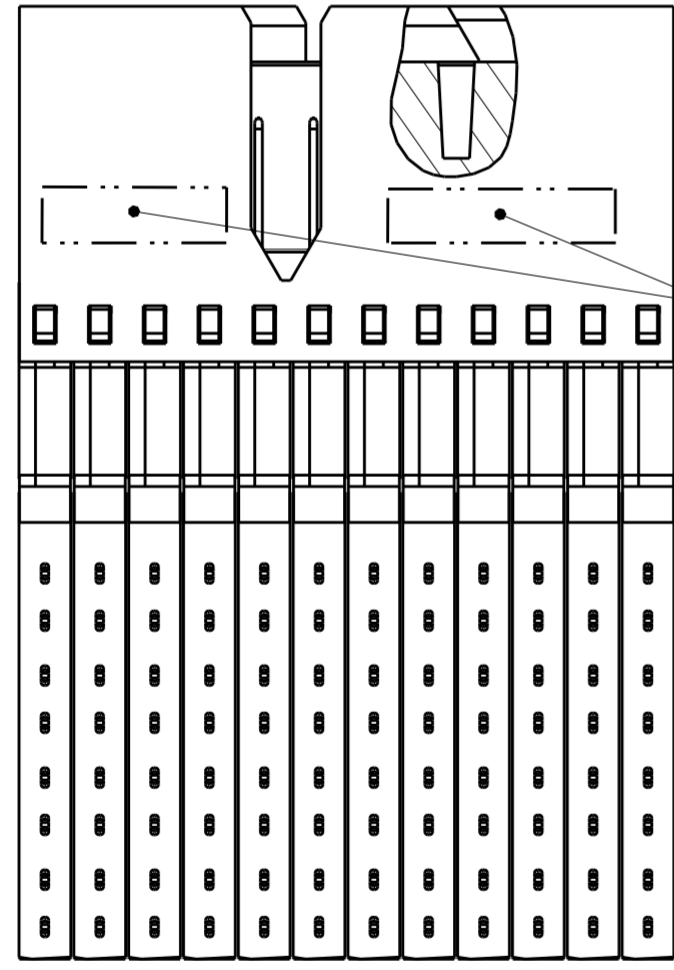
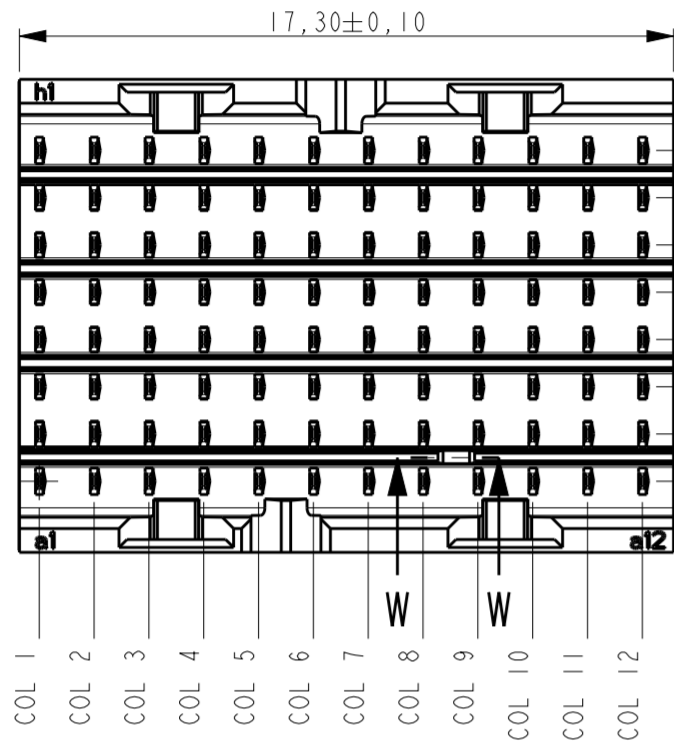
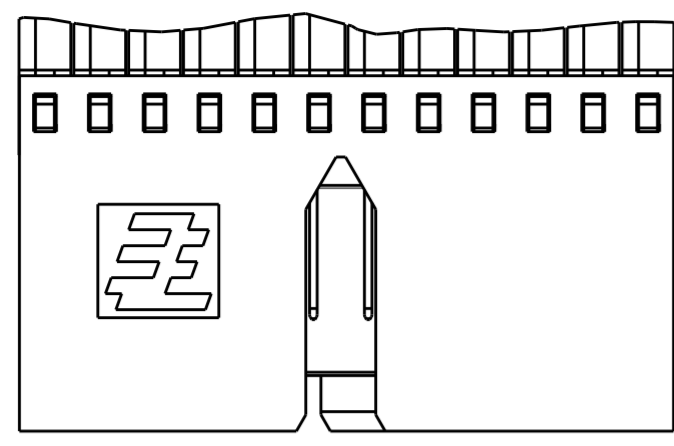
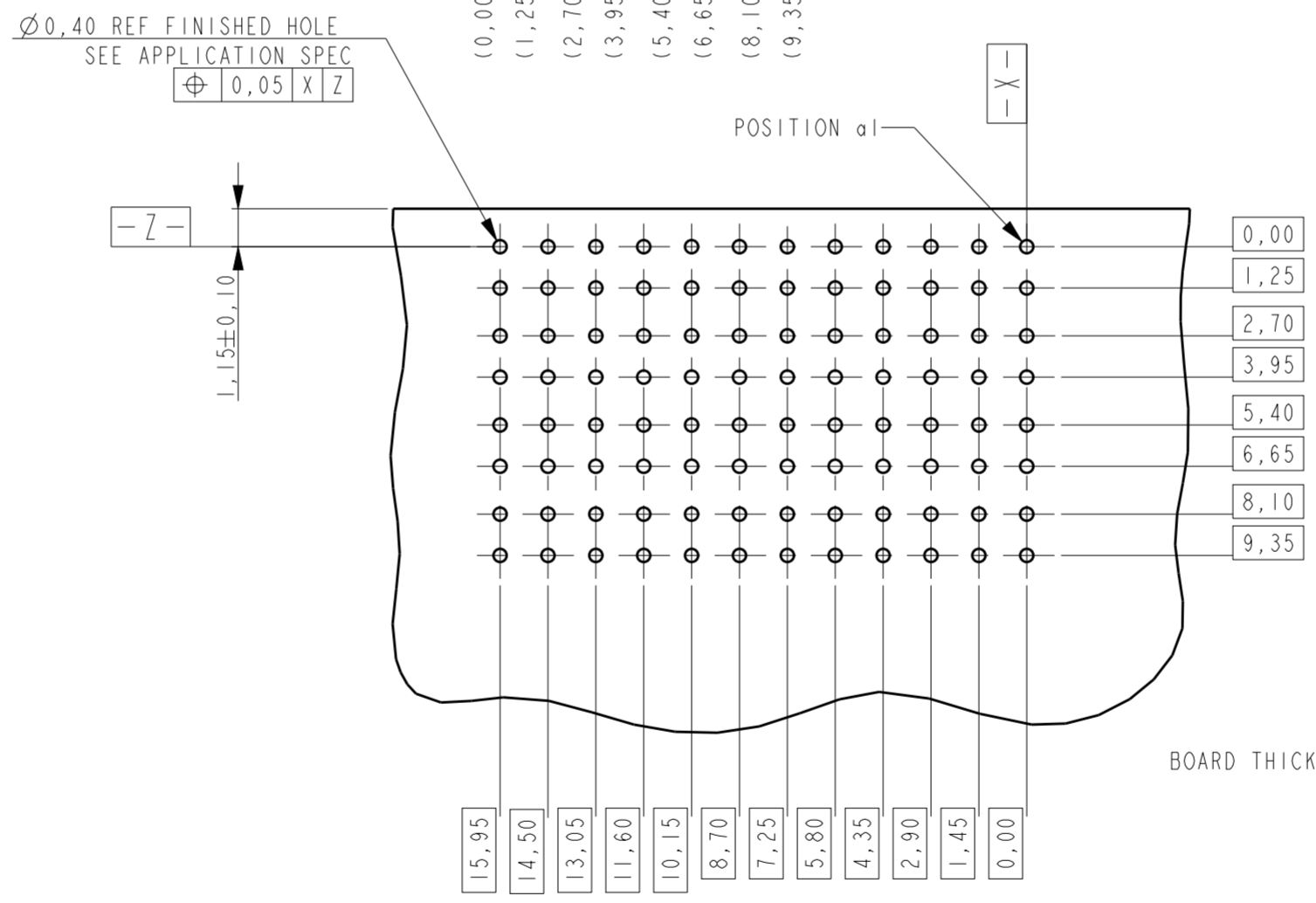

- NOTES:
- 1 PLATING: 0,5µm MIN. TIN OVER NICKEL.
  - 2 PLATING:

PARTNUMBER	PERFORMANCE LEVEL
2042162-1	PERFORMANCE LEVEL 1: CONNECTOR TESTED AND QUALIFIED AGAINST TELCORDIA GR-1217-CORE QUALITY LEVEL III: UNCONTROLLED ENVIRONMENT APPLICATIONS. SEE PRODUCT SPEC 108-19353
2042162-2	PERFORMANCE LEVEL 2: CONFORMS TO ALL TESTING ACCORDING PRODUCT SPEC 108-19320, -250 MATING CYCLES, 4 DAYS MIXED GAS TEST PER IEC 60068-2-60 METHOD 1

- 3 CONSULT APPLICATION SPEC OR CONTACT TE CONNECTIVITY FOR PERMISSIBLE CONTACT ASSIGNMENTS.
- 4 CONNECTOR MARKED WITH PARTNUMBER AND DATE CODE, DATE CODE DEFINITION: YYWWD.

RECOMMENDED PCB LAYOUT (COMPONENT SIDE SHOWN)

THIS DRAWING IS A CONTROLLED DOCUMENT.		DWN RA 21-Jan-09
DIMENSIONS: mm		CHK RA 21-Jan-09
TOLERANCES UNLESS OTHERWISE SPECIFIED:		APVD MW 21-Jan-09
0 PLC	±	PRODUCT SPEC
1 PLC	±	SEE NOTE 2
2 PLC	±	APPLICATION SPEC
3 PLC	±	114-19106
4 PLC	±	WEIGHT -
ANGLES	±	CUSTOMER DRAWING
FINISH	±	

3	OVERMOLD	LCP 30% GF NATURAL
2	HOUSING	LCP 30% GF NATURAL
1	CONTACT	COPPER ALLOY
ITEM NO.	DESCRIPTION	MATERIAL
<b>STE</b> TE Connectivity		
NAME RIGHT ANGLE MALE CONNECTOR Z-PACK Slim UHD High Speed		
SIZE	CAGE CODE	DRAWING NO
A2	00779	G-2042162
RESTRICTED TO	SCALE 5:1	SHEET 1 OF 1
		REV B