

CRD1610A-8W

8 Watt Reference Design

Features

- Quasi-resonant Flyback with Constant-current Output
- Flicker-free Dimming
- Line Voltage 120VAC, ±10%
- Rated Input Power: 8.1W
- Rated Output Power: 6.7W
- Output Voltage: 14.0V to 15.8V
- Efficiency: 84% at 460mA for 5×LEDs in Series
- Low Component Count
- Supports Cirrus Logic Product CS1610A

General Description

The CRD1610A-8W reference design demonstrates the performance of the CS1610A resonant mode AC/DC dimmable LED driver IC with a 460mA output driving 5×LEDs in series. It offers best-in-class dimmer compatibility with leading-edge, trailing-edge, center-cut, and digital dimmers. The form factor is targeted to fit into many LED bulb applications (A19, PAR).

DIMENSIONS (OVERALL)

Length	Width	Height
2.285" (58mm)	× 1.181" (29.9mm)	× 0.59" (15mm)

For more information, see Figure 3 on page 6.

ORDERING INFORMATION

CRD1610A-8W-Z 8 Watt Reference Design
Supports CS1610A

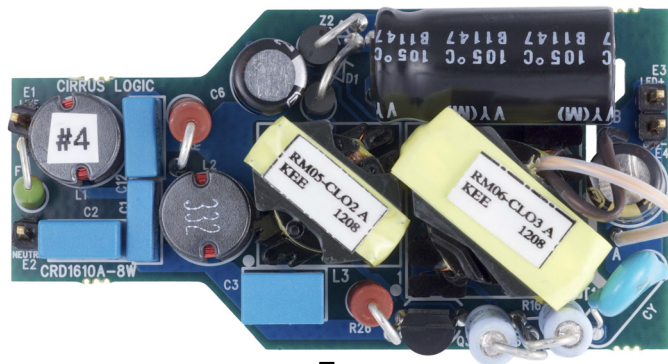

Top

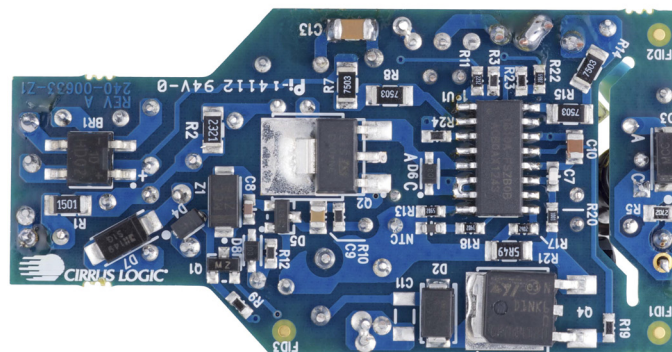

Bottom



IMPORTANT SAFETY INSTRUCTIONS

Read and follow all safety instructions prior to using this demonstration board.

This Engineering Evaluation Unit or Demonstration Board must only be used for assessing IC performance in a laboratory setting. This product is not intended for any other use or incorporation into products for sale.

This product must only be used by qualified technicians or professionals who are trained in the safety procedures associated with the use of demonstration boards.

DANGER Risk of Electric Shock

- The direct connection to the AC power line and the open and unprotected boards present a serious risk of electric shock and can cause serious injury or death. Extreme caution needs to be exercised while handling this board.
- Avoid contact with the exposed conductor or terminals of components on the board. High voltage is present on exposed conductor and it may be present on terminals of any components directly or indirectly connected to the AC line.
- Dangerous voltages and/or currents may be internally generated and accessible at various points across the board.
- Charged capacitors store high voltage, even after the circuit has been disconnected from the AC line.
- Make sure that the power source is off before wiring any connection. Make sure that all connectors are well connected before the power source is on.
- Follow all laboratory safety procedures established by your employer and relevant safety regulations and guidelines, such as the ones listed under, OSHA General Industry Regulations - Subpart S and NFPA 70E.

 **WARNING** Suitable eye protection must be worn when working with or around demonstration boards. Always comply with your employer's policies regarding the use of personal protective equipment.

 **WARNING** All components and metallic parts may be extremely hot to touch when electrically active.

Contacting Cirrus Logic Support

For all product questions and inquiries contact a Cirrus Logic Sales Representative. To find the one nearest to you go to www.cirrus.com

IMPORTANT NOTICE

Cirrus Logic, Inc. and its subsidiaries ("Cirrus") believe that the information contained in this document is accurate and reliable. However, the information is subject to change without notice and is provided "AS IS" without warranty of any kind (express or implied). Customers are advised to obtain the latest version of relevant information to verify, before placing orders, that information being relied on is current and complete. All products are sold subject to the terms and conditions of sale supplied at the time of order acknowledgment, including those pertaining to warranty, indemnification, and limitation of liability. No responsibility is assumed by Cirrus for the use of this information, including use of this information as the basis for manufacture or sale of any items, or for infringement of patents or other rights of third parties. This document is the property of Cirrus and by furnishing this information, Cirrus grants no license, express or implied under any patents, mask work rights, copyrights, trademarks, trade secrets or other intellectual property rights. Cirrus owns the copyrights associated with the information contained herein and gives consent for copies to be made of the information only for use within your organization with respect to Cirrus integrated circuits or other products of Cirrus. This consent does not extend to other copying such as copying for general distribution, advertising or promotional purposes, or for creating any work for resale.

CERTAIN APPLICATIONS USING SEMICONDUCTOR PRODUCTS MAY INVOLVE POTENTIAL RISKS OF DEATH, PERSONAL INJURY, OR SEVERE PROPERTY OR ENVIRONMENTAL DAMAGE ("CRITICAL APPLICATIONS"). CIRRUS PRODUCTS ARE NOT DESIGNED, AUTHORIZED OR WARRANTED FOR USE IN PRODUCTS SURGICALLY IMPLANTED INTO THE BODY, AUTOMOTIVE SAFETY OR SECURITY DEVICES, LIFE SUPPORT PRODUCTS OR OTHER CRITICAL APPLICATIONS. INCLUSION OF CIRRUS PRODUCTS IN SUCH APPLICATIONS IS UNDERSTOOD TO BE FULLY AT THE CUSTOMER'S RISK AND CIRRUS DISCLAIMS AND MAKES NO WARRANTY, EXPRESS, STATUTORY OR IMPLIED, INCLUDING THE IMPLIED WARRANTIES OF MERCHANTABILITY AND FITNESS FOR PARTICULAR PURPOSE, WITH REGARD TO ANY CIRRUS PRODUCT THAT IS USED IN SUCH A MANNER. IF THE CUSTOMER OR CUSTOMER'S CUSTOMER USES OR PERMITS THE USE OF CIRRUS PRODUCTS IN CRITICAL APPLICATIONS, CUSTOMER AGREES, BY SUCH USE, TO FULLY INDEMNIFY CIRRUS, ITS OFFICERS, DIRECTORS, EMPLOYEES, DISTRIBUTORS AND OTHER AGENTS FROM ANY AND ALL LIABILITY, INCLUDING ATTORNEYS' FEES AND COSTS, THAT MAY RESULT FROM OR ARISE IN CONNECTION WITH THESE USES.

Cirrus Logic, Cirrus, the Cirrus Logic logo designs, EXL Core, and the EXL Core logo design are trademarks of Cirrus Logic, Inc. All other brand and product names in this document may be trademarks or service marks of their respective owners.

1. INTRODUCTION

The CS1610A is a 120VAC quasi-resonant flyback mode dimmable LED controller IC. The CS1610A uses a digital control algorithm that is optimized for high efficiency and >0.90 power factor over a wide input voltage range (108VAC to 132VAC). The CS1610A integrates a critical conduction mode (CRM) boost converter that provides power factor correction and dimmer compatibility with a constant output current, quasi-resonant flyback stage. An adaptive dimmer compatibility algorithm controls the boost stage and dimmer compatibility operation mode to enable flicker-free operation to $<2\%$ output current with leading-edge, trailing-edge, and digital dimmers.

The CRD1610A-8W board is optimized to deliver low system cost in a high-efficiency, flicker-free, phase-dimmable, solid-state lighting (SSL) solution for incandescent lamp replacement applications. The feedback loop is closed through an integrated digital control system within the IC. The variation in switching frequency also provides a spread-frequency spectrum, thus minimizing the conducted EMI filtering requirements. Protection algorithms such as output open/short, current-sense resistor open/short, and overtemperature thermistors protect the system during abnormal conditions. Details of these features are provided in the CS1610A/11A/12A/13A *TRIAC Dimmable LED Driver IC* data sheet.

The CRD1610A-8W board demonstrates the performance of the CS1610A. This reference board has been designed for an output load of $5\times$ LEDs in series at 460mA (14.6V typical).

This document provides the schematic for the board. It includes oscilloscope screen shots that indicate various operating waveforms. Graphs are also provided that document the performance of the board in terms of Efficiency vs. Line Voltage, Output Current vs. Line Voltage, and Output Current vs. Dim Angle for the CS1610A dimmable LED controller IC.

Extreme caution needs to be exercised while handling this board. This board is to be used by trained professionals only.

2. SCHEMATIC

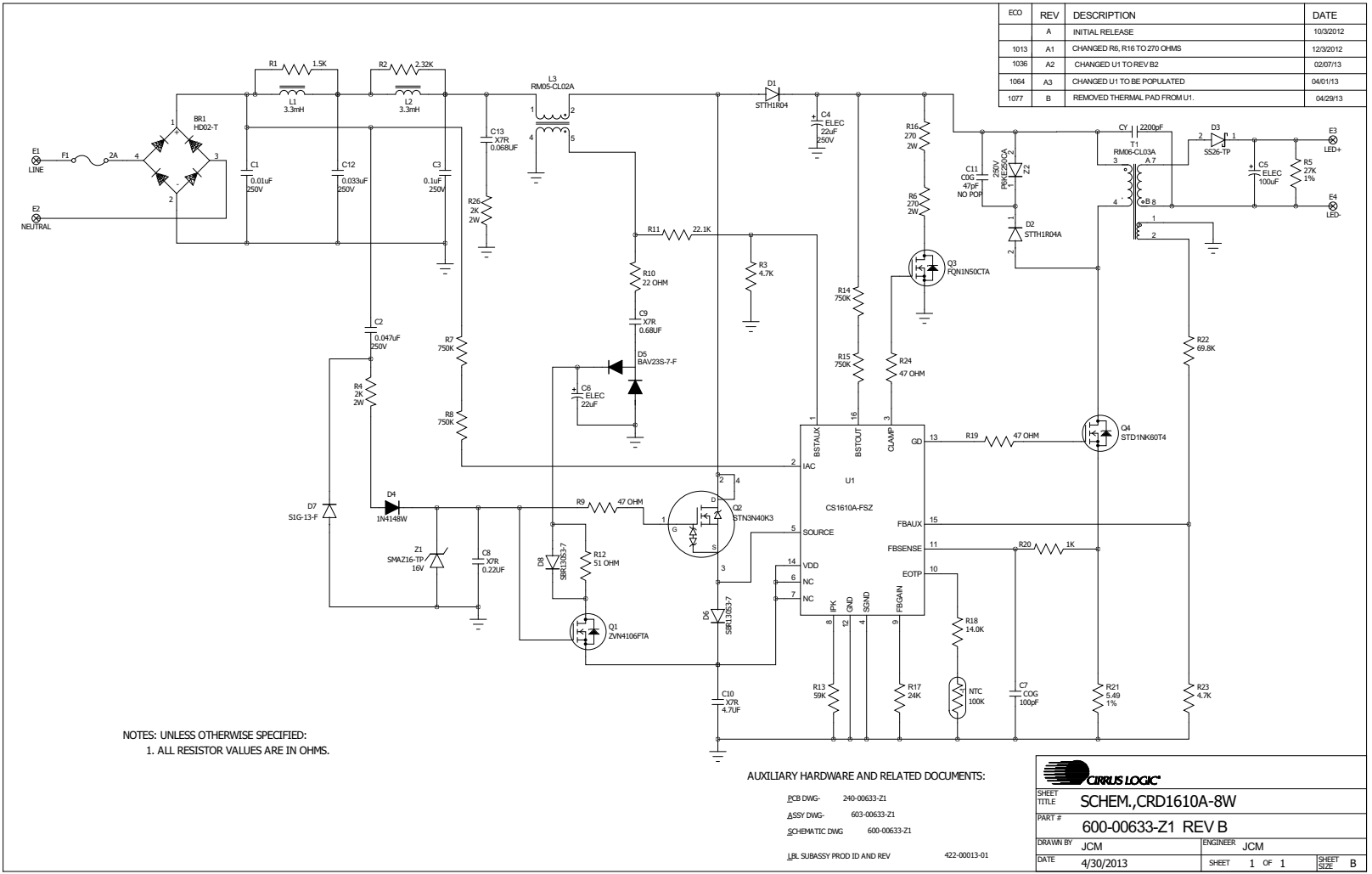

Figure 1. Schematic

3. BILL OF MATERIALS

Item	Rev	Description	Qty	Reference Designator	MFG	MFG P/N
1		DIODE RECT 200V 0.8A NPb MINIDIP	1	BR1	DIODES INC	HD02-T
2		CAP 0.01uF ±10% 250V POLY NPb RAD	1	C1	EPCOS	B32529C3103K
3		CAP 0.047uF ±5% 250V POLY NPb RAD	1	C2	EPCOS	B32529C3473J
4		CAP 0.1uF ±10% 250V POLY NPb RAD	1	C3	EPCOS	B32529C3104K
5		CAP 22uF ±20% 250V ELEC NPb RAD	1	C4	NICHICON	UVY2E220MPD
6		CAP 100uF ±20% 25V EL LO ESR NPb RD	1	C5	PANASONIC	EEUFM1E101
7		CAP 22UF ±20% 35V ELEC RAD	1	C6	PANASONIC	EEA-GA1V220H
8		CAP 100pF ±5% 50V COG NPb 0603	1	C7	KEMET	CO603C101J5GAC
9		CAP 0.22uF ±10% 25V X7R NPb 0603	1	C8	TDK	C1608X7R1E224K
10		CAP 0.68uF ±10% 50V X7R NPb 0805	1	C9	KEMET	C0805C684K5RAC
11		CAP 4.7uF ±10% 25V X7R NPb 0805	1	C10	TDK	C2012X7R1E475K
12		CAP 47pF ±5% 1000V COG NPb 1206	1	C11	JOHANSON DIELECTRICS	NP-102R18N470JV4E
13		CAP 0.033uF ±10% 250V POLY NPb RAD	1	C12	EPCOS	B32529C3333K
14		CAP 0.068uF ±10% 250V X7R NPb 1206	1	C13	KEMET	C1206C683KARAC
15		CAP 2200PF +80/-20% 2KV CER NPb RAD	1	CY	MURATA	DEBE33D222ZA2B
16		DIODE FAST 400V 1A NPb DO-41	1	D1	ST MICROELECTRONICS	STTH1R04
17		DIODE FAST 400V 1A NPb SMA	1	D2	ST MICROELECTRONICS	STTH1R04A
18		DIODE SKY RECT 60V 2A NPb DO-214AC	1	D3	MICRO COMMERCIAL(MCC)	SS26-TP
19		DIODE FAST SW 75V 350mW NPb SOD123	1	D4	DIODES INC	1N4148W-7-F
20		DIODE SWT 250V 0.4A NPb SOT-23	1	D5	DIODES INC	BAV23S-7-F
21		DIODE RECT 30V 1A NPb SOD-323	2	D6 D8	DIODES INC	SBR130S3-7
22		DIODE RECT 400V 1A NPb SMA	1	D7	DIODES INC	S1G-13-F
23		NO POP PAD H40 P64 NPb TH	4	E1 E2 E3 E4	NO POP	NP-PAD-H40P64
24		FUSE 2A 125V VFA NPb AXL	1	F1	LITTELFUSE	0251002.MXL
25		IND 3.3mH ±10% 11.8OHM DCR NPb TH	2	L1 L2	COILCRAFT	RFB0807-332L
26		XFMR 1.45mH 10% NPb TH	1	L3	KUNSHAN EAGERNESS	RM05-CLO2A
27		THERM 100K OHM ±5% 0.10mA NPb 0603	1	NTC	MURATA	NCP18WF104J03RB
28		TRAN MOSFET nCH 60V.2A NPb SOT23-3	1	Q1	DIODES INC	ZVN4106FTA
29		TRAN MOSFT nCH 1.8A 400V NPb SOT223	1	Q2	ST MICROELECTRONICS	STN3N40K3
30		TRAN MOSFET nCH 0.38A 500V NPb TO-92	1	Q3	FAIRCHILD	FQN1N50CTA
31		TRAN MOSFET nCH 1.0A 600V NPb DPAK	1	Q4	ST MICROELECTRONICS	STD1NK60T4
32		RES 1.5k OHM 1/4W ±1% NPb 1206	1	R1	DALE	CRCW12061K50FKFA
33		RES 2.32k OHM 1/4W ±1% 1206 FILM	1	R2	DALE	CRCW12062K32FKFA
34		RES 4.70K OHM 1/10W ±1% NPb 0603	2	R3 R23	PANASONIC	ERJ3EK4701V
35		RES PWR 2.0K OHM 2W ±5% NPb AXL	2	R4 R26	VISHAY	PRO2000202001JR500
36		RES 27K OHM 1/8W ±1% NPb 0805	1	R5	PANASONIC	ERJ6ENF2702V
37		RES 270 OHM 2W ±5% MTL FLN NPb AXL	2	R6 R16	PANASONIC	ERG2S1271
38		RES 750k OHM 1/4W ±1% 1206 FILM	4	R7 R8 R14 R15	DALE	CRCW1206750KFKEA
39		RES 47 OHM 1/10W ±1% NPb 0603	3	R9 R19 R24	PANASONIC	ERJ3EK47R0V
40		RES 22.0 OHM 1/10W ±1% NPb 0603	1	R10	PANASONIC	ERJ3EK22R0V
41		RES 22.1k OHM 1/10W ±1% NPb 0603	1	R11	DALE	CRCW060322K1FKFA
42		RES 51.0 OHM 1/10W ±1% NPb 0603	1	R12	PANASONIC	ERJ3EK51R0V
43		RES 59k OHM 1/10W ±1% NPb 0603 FILM	1	R13	DALE	CRCW060359K0FKFA
44		RES 24k OHM 1/10W ±1% NPb 0603 FILM	1	R17	DALE	CRCW060324K0FKFA
45		RES 14k OHM 1/10W ±1% NPb 0603 FILM	1	R18	DALE	CRCW060314K0FKFA
46		RES 1k OHM 1/10W ±1% NPb 0603 FILM	1	R20	DALE	CRCW06031K00FKFA
47		RES 5.49 OHM 1/4W ±1% NPb 1206 FLM	1	R21	DALE	CRCW12065R49FKFA
48		RES 69.8k OHM 1/10W ±1% NPb 0603	1	R22	DALE	CRCW060369K8FKFA
49		XFMR 3.1mH 10% NPb TH	1	T1	KUNSHAN EAGERNESS	RM06-CLO3A
50	B2	IC CRUS DIM 120V LED DRV NPb SOIC16	1	U1	CIRRUS LOGIC	CS1610A-FS2/B2
51		DIODE ZENER 16V 1W NPb DO-214AC	1	Z1	MICRO COMMERCIAL	SMAZ16-TP
52		DIODE TVS 250V 600W BID NPb AXL	1	Z2	ST MICROELECTRONICS	P6KE250CA

Figure 2. Bill of Materials

4. BOARD LAYOUT

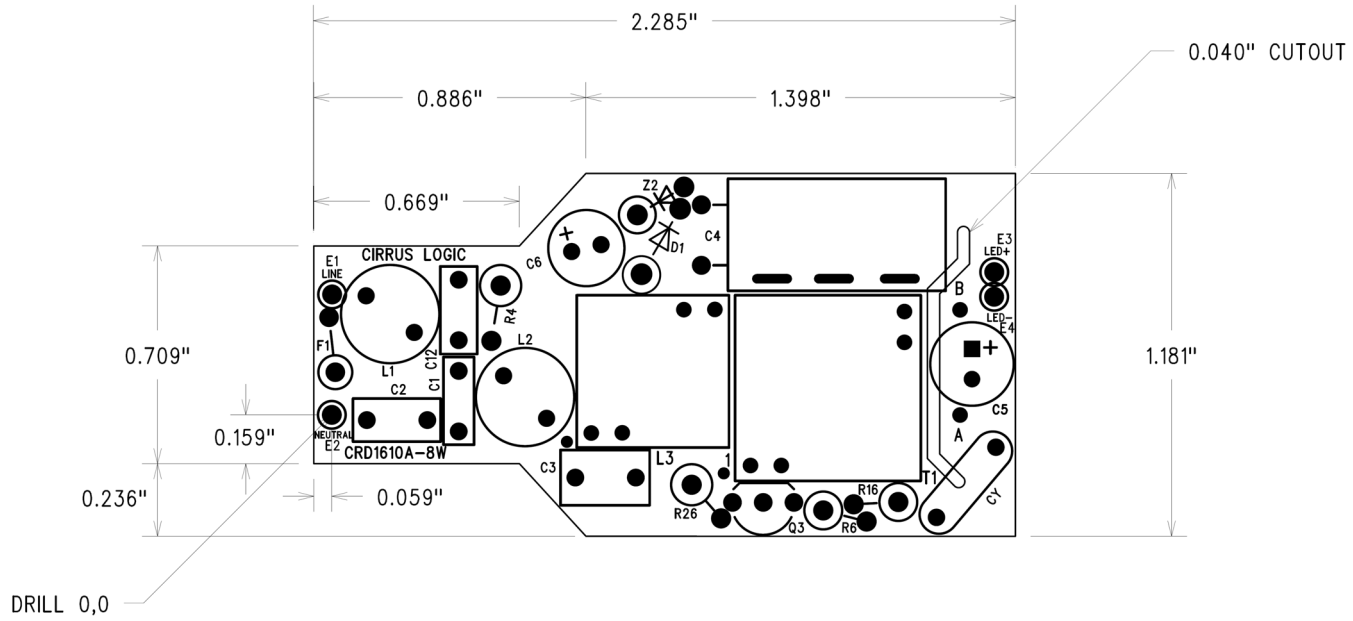

Figure 3. PCB Dimensions

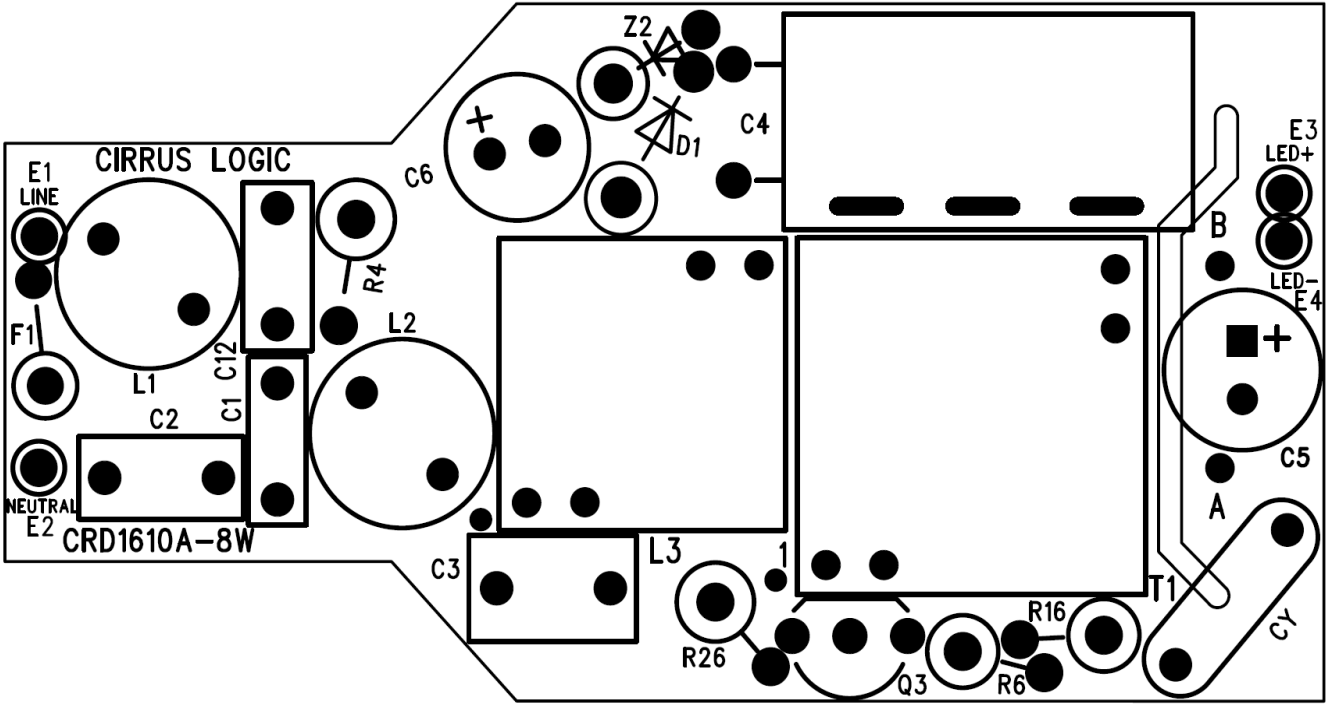

Figure 4. Top Silkscreen

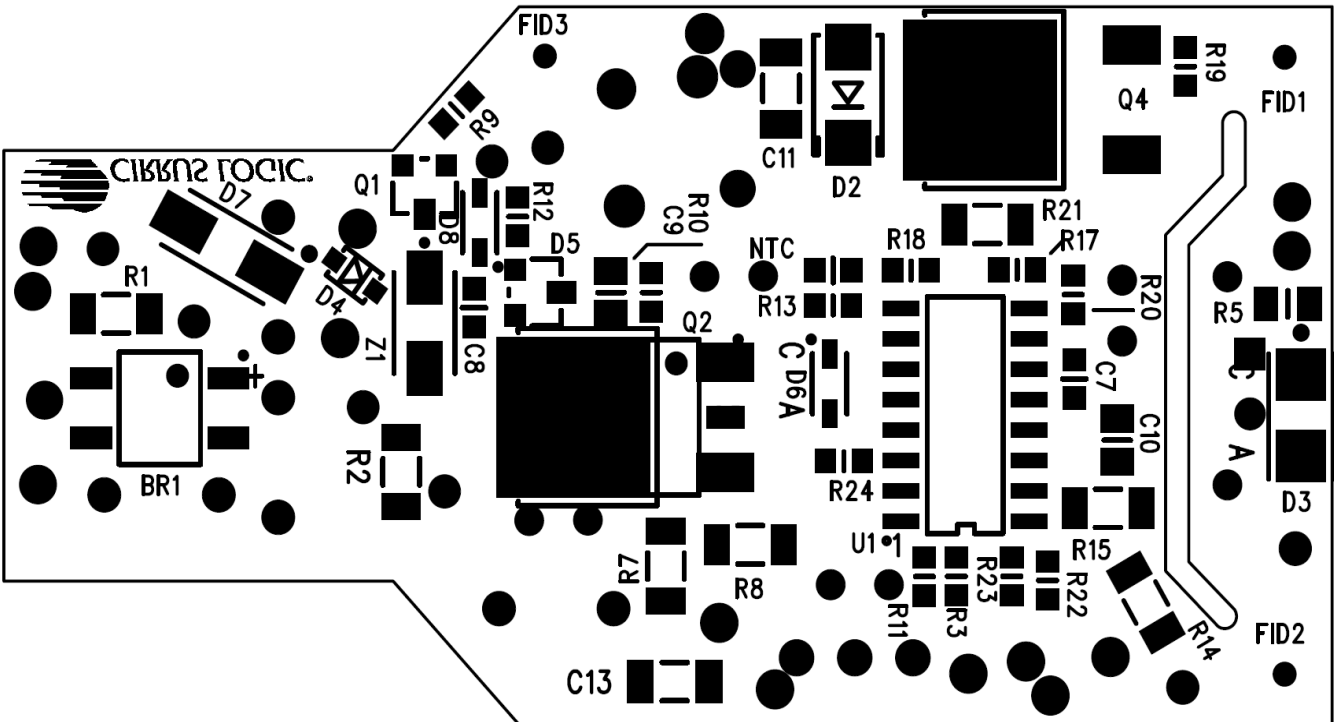

Figure 5. Bottom Silkscreen

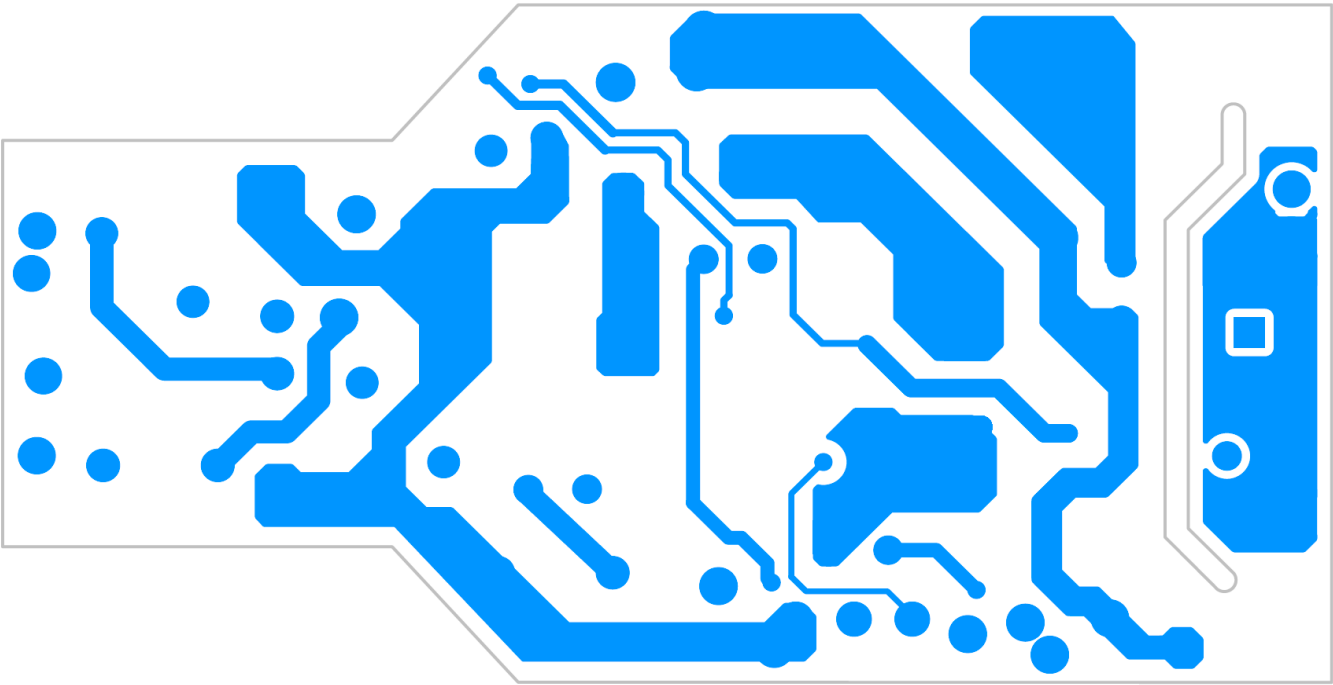

Figure 6. Top Routing

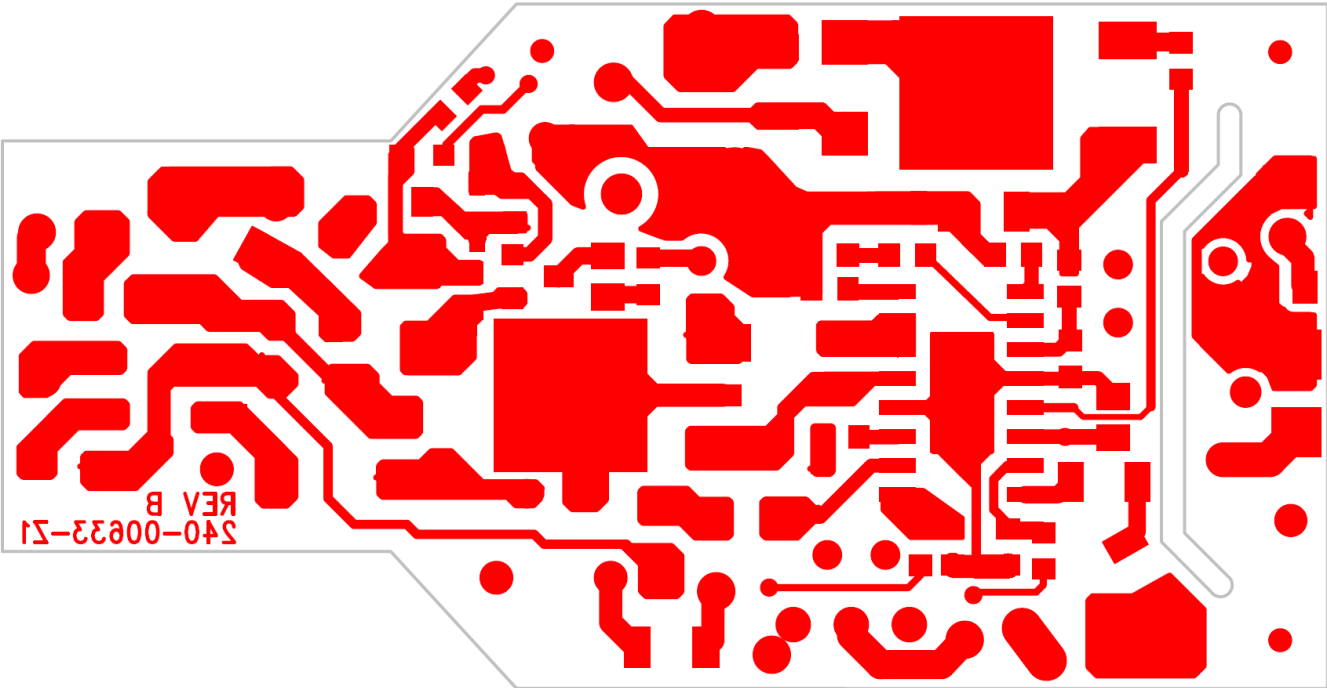

Figure 7. Bottom Routing

5. THERMAL IMAGING

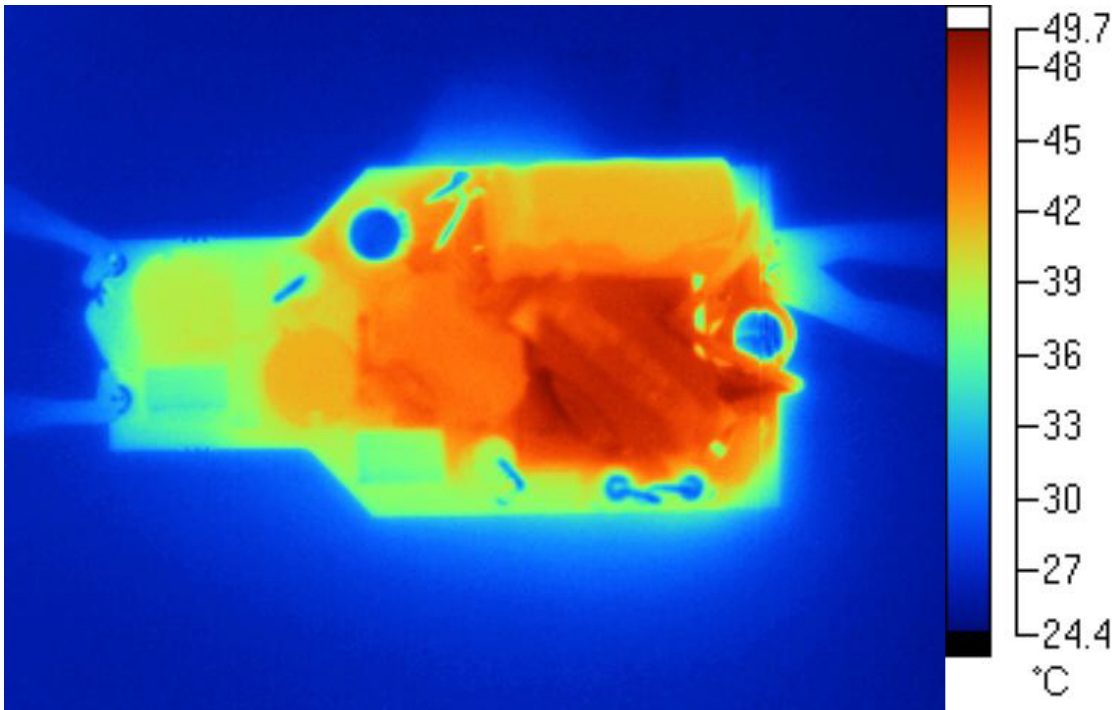

Figure 8. Top Thermal

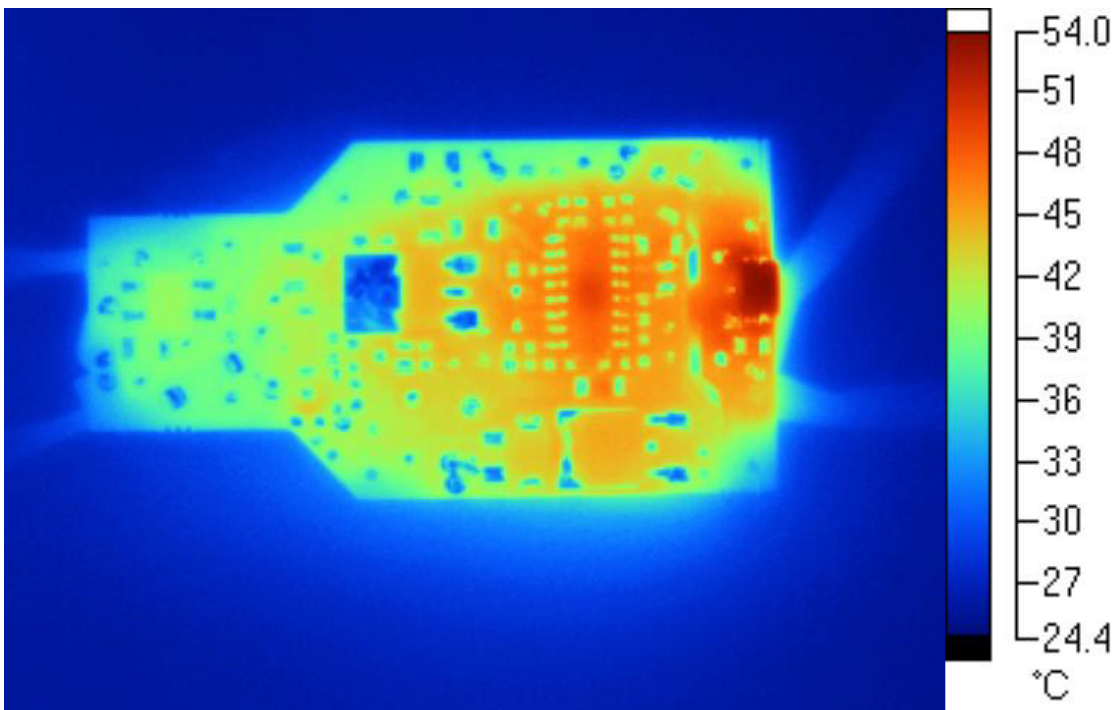

Figure 9. Bottom Thermal

6. DIMMER COMPATIBILITY

PAR 16 Lamp with a CS1610A (120V/60Hz)			
Date	11/15/2012	Power Factor^{1,4}	0.96
Vendor	Cirrus Logic	EN55015 Compliant (Y/N)	Y
Input Voltage	120V/60Hz	Nominal Input Power (W)^{1,4}	6.94
Form Factor	PAR 16	Maximum Input Power (W)^{1,4}	8.5
Model #	CRD1610A-8W	Output Voltage (V)^{1,2}	12
IC	CS1610A	Output Current (mA)^{1,2}	475
Topology	Boost/Flyback	Output Current Ripple ≤ 120Hz (mA)^{1,3}	0
Isolation (Y/N)	Y	Output Power (W)^{1,4}	5.7
Efficiency (%)	82.1%		

Dimmer ⁵		Flicker Free Steady-State			Monotonic Dimming			Max I _{out} (%)			Min I _{out} (%)		
Manufacture	Type	# of lamps			# of lamps			# of lamps			# of lamps		
		1	5	10	1	5	10	1	5	10	1	5	10
Cooper 38T	Leading Edge	Y	Y	Y	Y	Y	Y	99.8	99.8	99.8	2.1	2.1	2.1
Cooper 6001A	Leading Edge	Y	Y	Y	Y	Y	Y	99.8	99.8	99.8	2.1	2.1	2.1
Cooper 9530DS	Leading Edge	Y	Y	Y	Y	Y	Y	99.8	99.8	100.0	2.1	2.1	2.1
GE 52136	Leading Edge	Y	Y	Y	Y	Y	Y	99.8	99.8	99.8	2.1	2.1	2.1
Leviton 6161	Leading Edge	Y	Y	Y	Y	Y	N	99.8	99.8	99.8	2.1	2.1	2.1
Leviton 6613	Leading Edge	Y	Y	Y	Y	Y	Y	99.8	99.8	99.8	2.1	2.1	2.1
Leviton 6615	Trailing Edge	Y	Y	Y	Y	Y	Y	99.6	99.6	99.6	2.3	2.1	2.1
Leviton 6627	Leading Edge	Y	Y	Y	Y	Y	Y	99.8	99.8	99.8	9.5	9.3	8.8
Leviton 6631	Leading Edge	Y	Y	Y	Y	Y	Y	99.8	99.8	99.8	2.1	2.1	2.1
Leviton 6641	Leading Edge	Y	Y	Y	Y	Y	Y	99.8	99.8	99.8	2.1	2.1	2.1
Leviton 6674	Leading Edge	Y	Y	Y	Y	Y	Y	99.8	99.8	99.8	2.1	2.1	2.1
Leviton 6683	Leading Edge	Y	Y	Y	Y	Y	Y	100.0	99.8	99.8	2.1	2.1	2.1
Leviton 6684	Leading Edge	Y	Y	Y	Y	Y	Y	99.8	99.8	99.8	2.1	2.1	2.1
Leviton 700	Leading Edge	Y	Y	Y	Y	Y	Y	99.8	99.8	99.8	2.1	2.1	2.1
Leviton ACE04	Trailing Edge	Y	Y	Y	Y	Y	Y	99.6	99.6	99.6	2.1	2.1	2.1
Leviton ACM06	Leading Edge	Y	Y	Y	Y	Y	Y	99.8	99.8	99.8	2.1	2.1	2.1
Leviton ACX10	Leading Edge	Y	Y	Y	Y	Y	Y	99.8	99.8	99.8	8.2	8.2	8.0
Leviton HCM06	Leading Edge	Y	Y	Y	Y	Y	N	99.8	99.8	99.8	2.1	2.1	2.1
Leviton IPI06-1L	Leading Edge	Y	Y	Y	Y	Y	Y	99.8	99.8	99.8	2.1	2.1	2.1
Leviton IPL06	Leading Edge	Y	Y	Y	Y	Y	Y	99.8	99.8	99.8	2.1	2.1	2.1
Leviton PR180	Motion Detection	Y	Y	Y	Y	Y	Y	99.8	99.8	99.8	0.0	0.0	0.0
Leviton VZM06	Leading Edge	Y	Y	Y	Y	Y	Y	99.8	99.8	99.8	2.1	2.1	2.1
Lutron AB-600	Leading Edge	Y	Y	Y	Y	Y	Y	99.8	99.8	99.8	2.1	2.1	2.1

Dimmer ⁵		Flicker Free Steady-State			Monotonic Dimming			Max I _{out} (%)			Min I _{out} (%)		
Manufacture	Type	# of lamps			# of lamps			# of lamps			# of lamps		
		1	5	10	1	5	10	1	5	10	1	5	10
Lutron AYCL-153P	Leading Edge	Y	Y	Y	Y	Y	Y	99.8	99.8	99.8	3.2	3.4	3.2
Lutron CTCL-153P	Leading Edge	Y	Y	Y	Y	Y	Y	99.8	99.8	99.8	4.2	4.2	3.8
Lutron DV-600P	Leading Edge	Y	Y	Y	Y	Y	Y	99.8	99.8	99.8	2.1	2.1	2.1
Lutron DVCL-153P	Leading Edge	Y	Y	Y	Y	Y	Y	99.8	99.8	99.8	2.1	2.1	2.1
Lutron DVELV-300P	Trailing Edge	Y	Y	Y	Y	Y	Y	98.9	97.5	96.0	2.1	2.1	2.1
Lutron GL-600H	Leading Edge	Y	Y	Y	Y	Y	Y	99.8	99.8	99.8	2.1	2.1	2.1
Lutron LGCL-153PLH	Leading Edge	Y	Y	Y	Y	Y	Y	99.8	99.8	99.8	2.5	2.5	2.3
Lutron MACL-153M	Leading Edge	Y	Y	Y	Y	Y	Y	95.6	95.6	94.9	2.1	2.1	2.1
Lutron MAW600	Leading Edge	Y	Y	Y	Y	Y	Y	99.8	99.8	99.8	2.1	2.1	2.1
Lutron MIR-600	Leading Edge	Y	Y	Y	Y	Y	Y	99.8	99.8	99.8	2.1	2.1	2.1
Lutron MRF2-6ND-120	Leading Edge	Y	Y	Y	Y	Y	Y	99.8	99.8	99.8	2.1	2.1	2.1
Lutron MS-0PS6M-DV	Occupancy Sensor	Y	Y	Y	Y	Y	Y	99.8	99.8	100.0	0.0	0.0	0.0
Lutron NT2000	Leading Edge	Y	Y	Y	Y	Y	Y	99.8	99.8	99.8	2.1	2.1	2.1
Lutron NTELV-600	Trailing Edge	Y	Y	Y	Y	Y	Y	92.2	90.5	89.9	2.1	2.1	2.1
Lutron NTLV-600	Leading Edge	Y	Y	Y	Y	Y	Y	99.8	99.8	99.8	2.1	2.1	2.1
Lutron S-103P	Leading Edge	Y	Y	Y	Y	Y	Y	99.8	99.8	99.8	2.1	2.1	2.1
Lutron S-600P	Leading Edge	Y	Y	Y	Y	Y	Y	99.8	99.8	99.8	2.1	2.1	2.1
Lutron SELV-303P	Trailing Edge	Y	Y	Y	Y	Y	Y	86.7	85.3	84.0	2.1	2.1	2.1
Lutron SLV-600P	Leading Edge	Y	Y	Y	Y	Y	Y	99.8	99.8	99.8	2.1	2.1	2.1
Lutron SLV-603P	Leading Edge	Y	Y	Y	Y	Y	Y	99.8	99.8	99.8	2.1	2.1	2.1
Lutron SPS-600	Leading Edge	Y	Y	N	Y	Y	Y	99.8	99.8	99.8	2.1	2.1	2.1
Lutron SPSLV-1000	Leading Edge	Y	Y	N	Y	Y	Y	99.8	99.8	99.8	2.1	2.1	2.1
Lutron TG-600P	Leading Edge	Y	Y	Y	Y	Y	Y	99.8	99.8	99.8	2.1	2.1	2.1
Lutron TGCL-153PH	Leading Edge	Y	Y	Y	Y	Y	Y	99.8	99.8	99.8	3.4	3.4	3.2
Lutron TTCL-100H	Leading Edge	Y	Y	Y	Y	Y	Y	99.8	99.8	99.8	2.1	2.1	2.1
Pass & Seymour RW500U	Occupancy Sensor	Y	Y	Y	Y	Y	Y	99.8	98.7	98.3	0.0	0.0	0.0
Smarthome 2486DIV6	Leading Edge	Y	Y	Y	Y	Y	Y	99.8	99.8	99.8	2.1	2.1	2.1

- Notes:
1. Tested at nominal input voltage, nominal input frequency and without a dimmer after soaking for 15 minutes
 2. Average
 3. Peak-to-peak
 4. Measured with Chroma 66202 Power Analyzer
 5. This document includes trademarks, trade names, brands, logos, product names and/or product identifiers of companies other than Cirrus Logic, Inc. All such trademarks, trade names, brands, logos, product names, and product identifiers are for identification purposes only and are the property of their respective owners, who are not affiliated with Cirrus Logic. Please visit the respective sites of those owners to obtain a listing or understanding of their trademark rights. This document also includes results from testing performed by Cirrus Logic for its own purposes and for which there are currently no industry standards. While this testing was applied objectively, its results may include at least some degree of subjectivity. The testing or test results should not be interpreted as any comment on the overall quality or suitability of any tested products.

7. INDUCTOR CONSTRUCTION

The CRD1610A-8W includes a critical conduction mode (CRM) boost converter that provides power factor correction and dimmer compatibility with a constant output current, quasi-resonant flyback stage. The following sections describe the boost and flyback inductors installed on the CRD1610A-8W.

7.1 Boost Inductor

The CS1610A uses an adaptive dimmer compatibility algorithm to control the boost inductor stage, which guarantees dimmer compatibility operation plus enables flicker-free operation with leading-edge, trailing-edge, and digital dimmers. The boost auxiliary winding is used for zero-current detection (ZCD) and supplies power to the CS1610A.

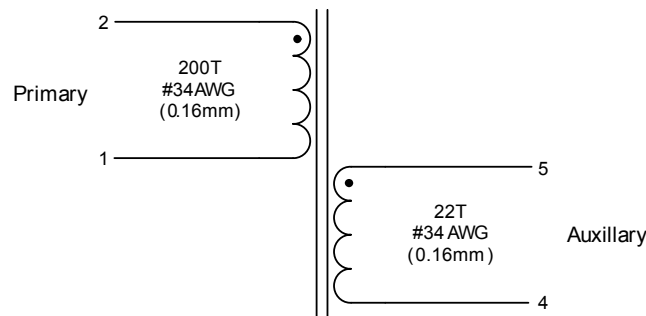

Figure 10. Boost Inductor Schematic

7.1.1 Electrical Specifications

Characteristics conditions:

- Operating temperature range: -25 °C to +120 °C (including coil heat)

Parameter	Condition	Symbol	Min	Typ	Max	Unit
Boost Inductor						
Primary Inductance	(Note 1) $f_{\text{resonant}}=10\text{kHz}$, 0.3V at 20°C	L_p	1.305	1.45	1.595	mH
Primary DC Resistance	(Note 1) $t_{\text{DCR}}=20^\circ\text{C}$		3.28	4.1	4.92	Ω
Auxiliary DC Resistance	(Note 2) $t_{\text{DCR}}=20^\circ\text{C}$		0.456	0.57	0.684	Ω

- Notes:
1. Measured across pins 1 and 2
 2. Measured across pins 5 and 4

7.2 Flyback Transformer

The flyback transformer stage is a quasi-resonant current-regulated DC-DC Converter capable of delivering the highest possible efficiency at a constant current while minimizing line frequency ripple. The auxiliary winding is used for zero-current detection and overvoltage protection.

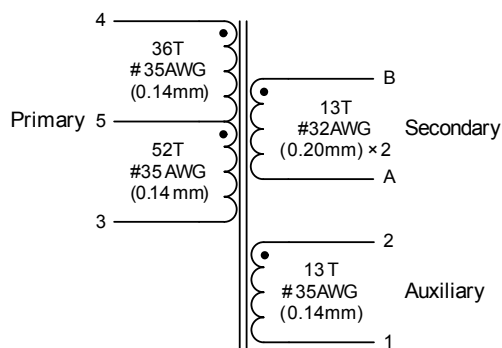

Figure 11. Flyback Transformer Schematic

7.2.1 Electrical Specifications

Characteristics conditions:

- Operating temperature range: -25 °C to +120 °C (including coil heat)

Parameter	Condition	Sym	Min	Typ	Max	Unit
Flyback Transformer						
Electrical Strength	(Note 3) $f_{operate}=50/60\text{Hz}$		-	4	-	kV _{RMS}
Primary Inductance	(Note 4) $f_{resonant}=10\text{kHz}, 0.3\text{V at }20^{\circ}\text{C}$	L _P	2.79	3.1	3.41	mH
Primary Leakage Inductance	(Note 4) $f_{resonant}=10\text{kHz}, 0.3\text{V at }20^{\circ}\text{C}$	L _K	-	-	15	μH
Primary DC Resistance	(Note 4) $t_{DCR}=20^{\circ}\text{C}$		2.175	2.90	3.625	Ω
Secondary DC Resistance	(Note 5) $t_{DCR}=20^{\circ}\text{C}$		-	-	0.22	Ω
Auxiliary DC Resistance	(Note 6) $t_{DCR}=20^{\circ}\text{C}$		0.3975	0.53	0.6625	Ω

- Notes:
3. Time = 2s
 4. Measured across pins 3 and 4
 5. Measured across pins B and A
 6. Measured across pins 2 and 1

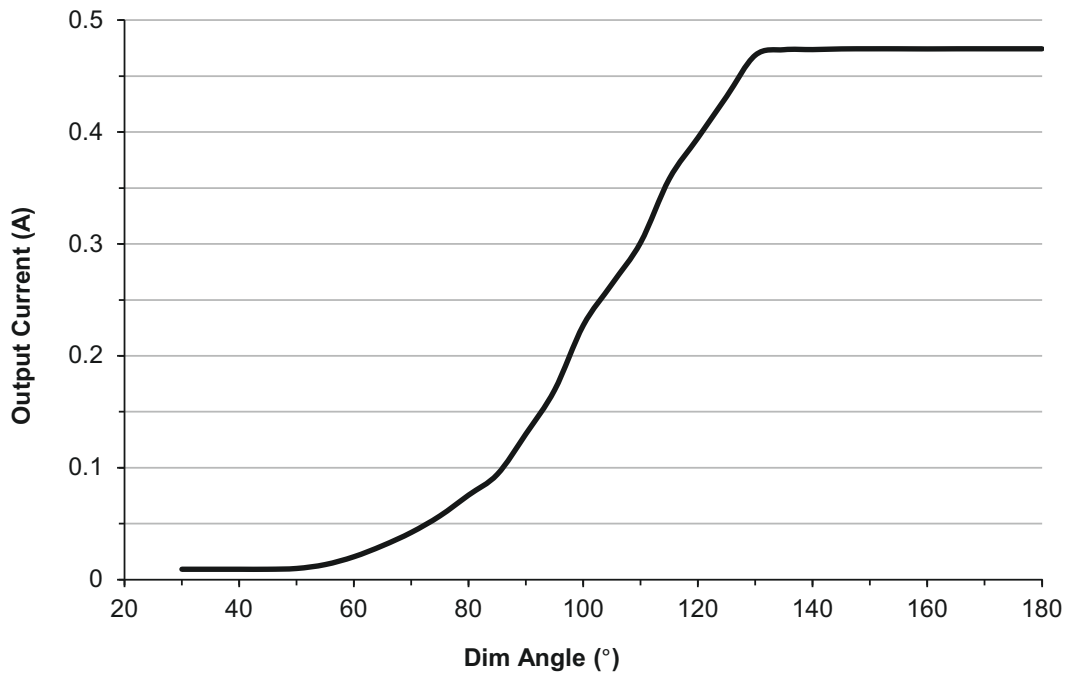
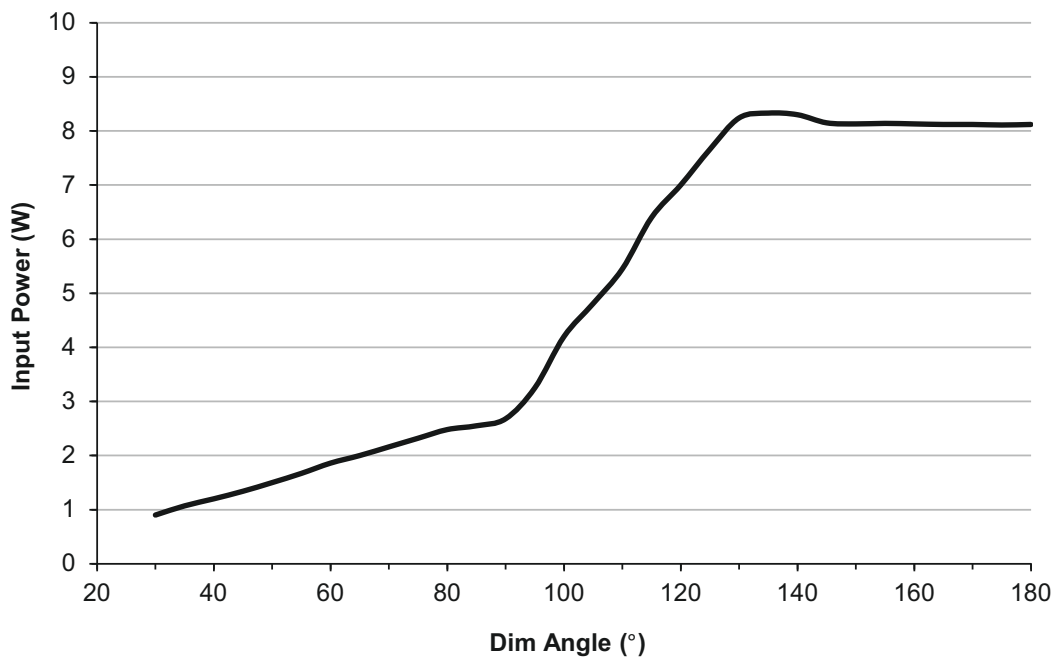
8. PERFORMANCE PLOTS

Figure 12. Typical Output Current vs. Dim Angle

Figure 13. Typical Input Power vs. Dim Angle

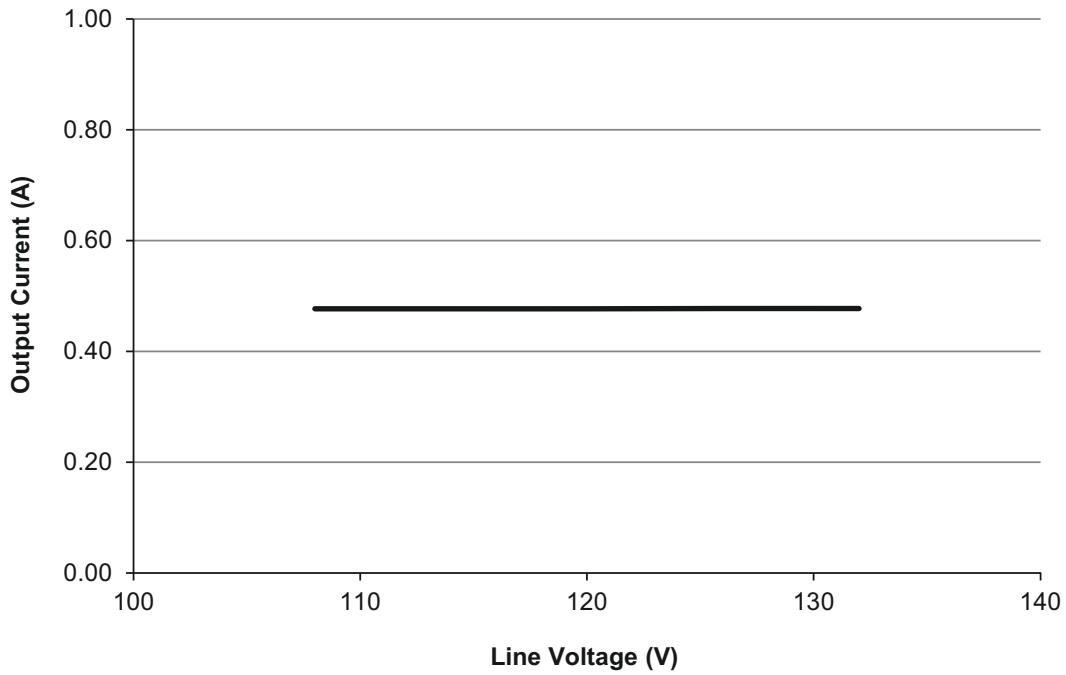

Figure 14. Output Current vs. Line Voltage, 108VAC to 132VAC

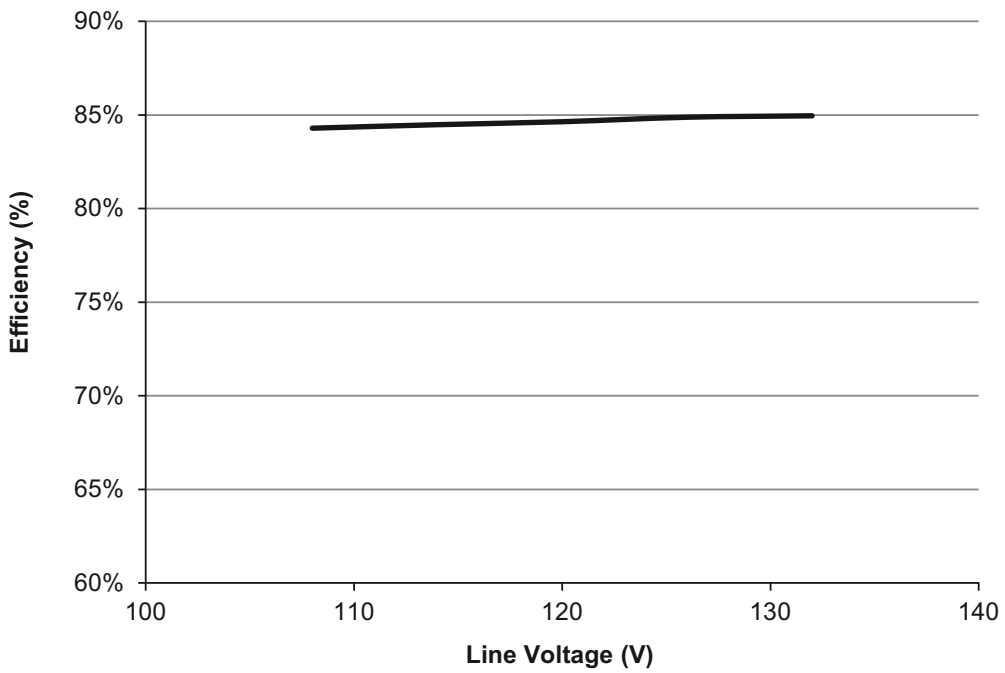

Figure 15. Typical Efficiency vs. Line Voltage, 108VAC to 132VAC

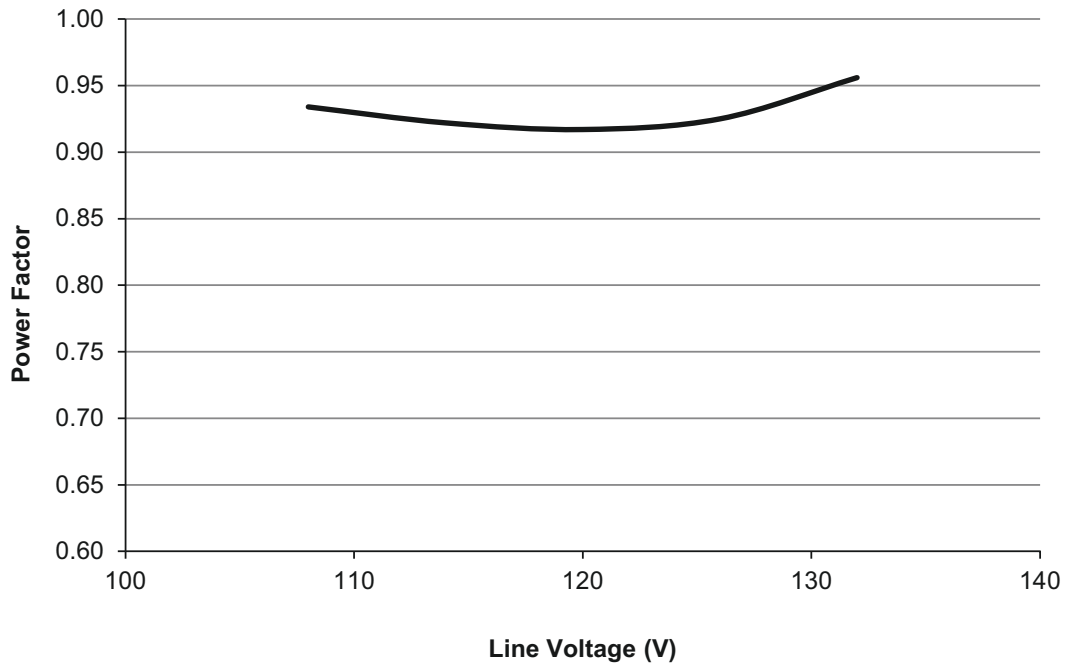

Figure 16. Power Factor vs. Line Voltage, 108VAC to 132VAC

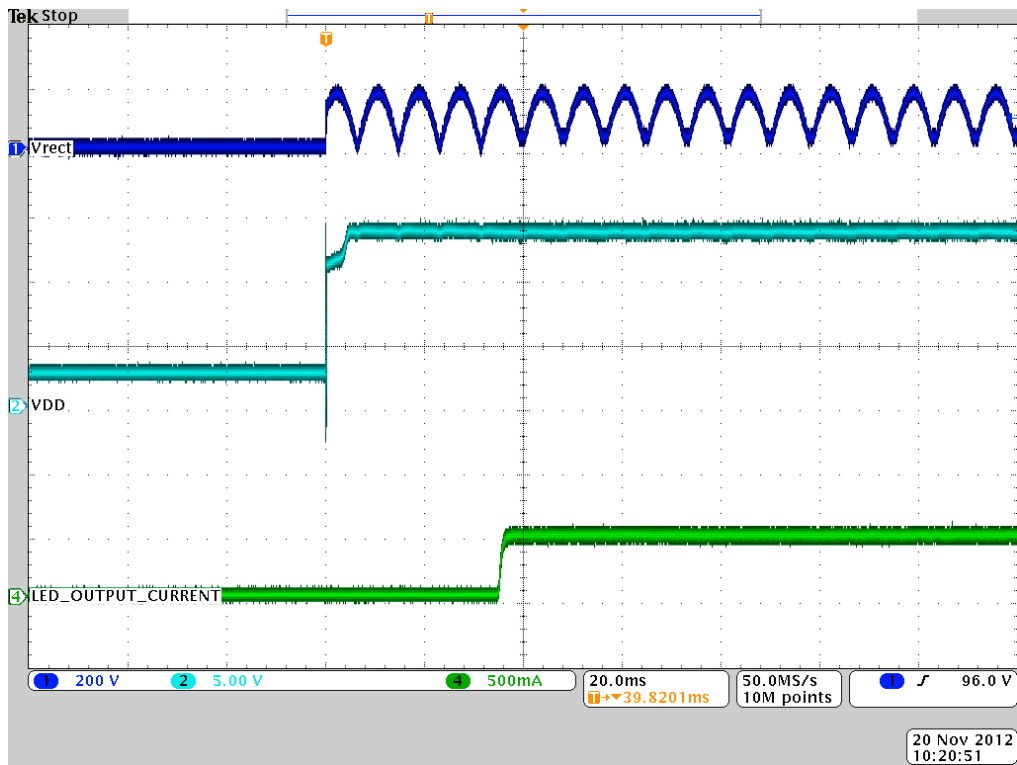

Figure 17. No-dimmer Mode, Startup, 120 VAC

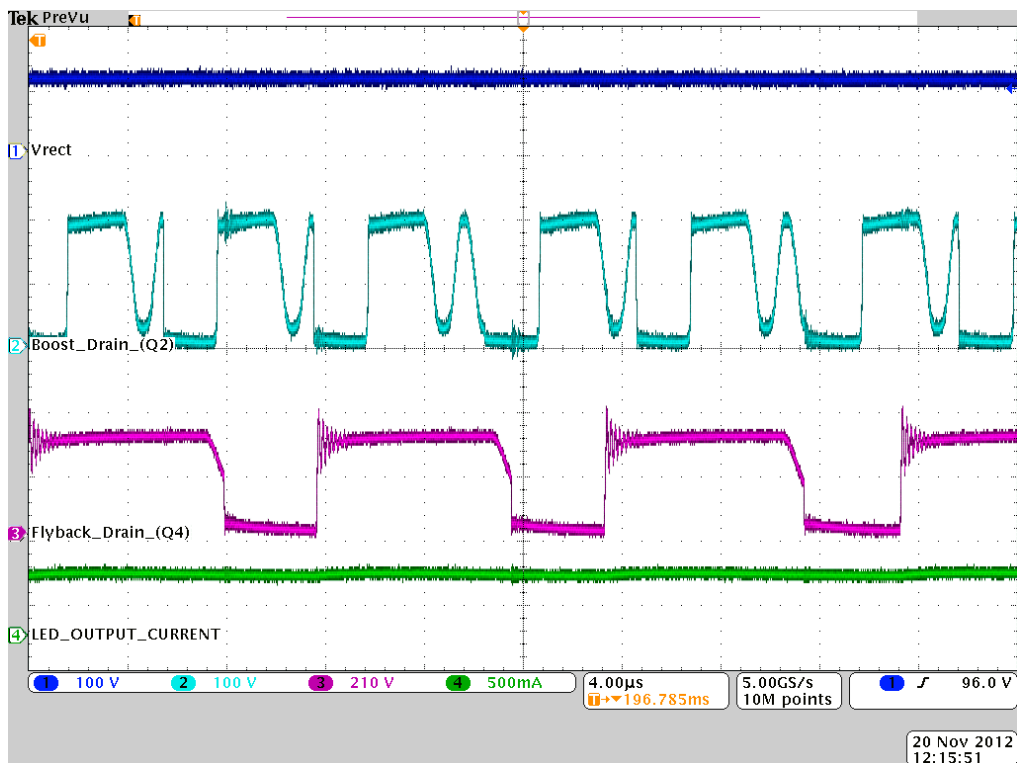

Figure 18. No-dimmer Mode, Steady-state, 120 VAC

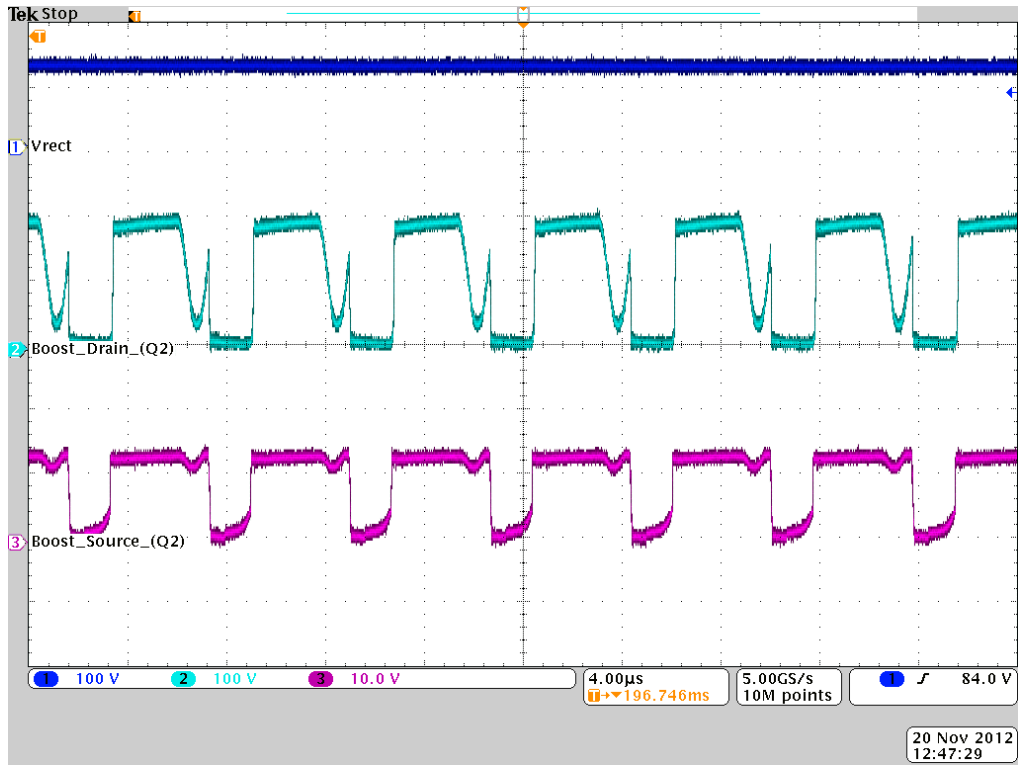

Figure 19. Boost FET Q2 Waveform

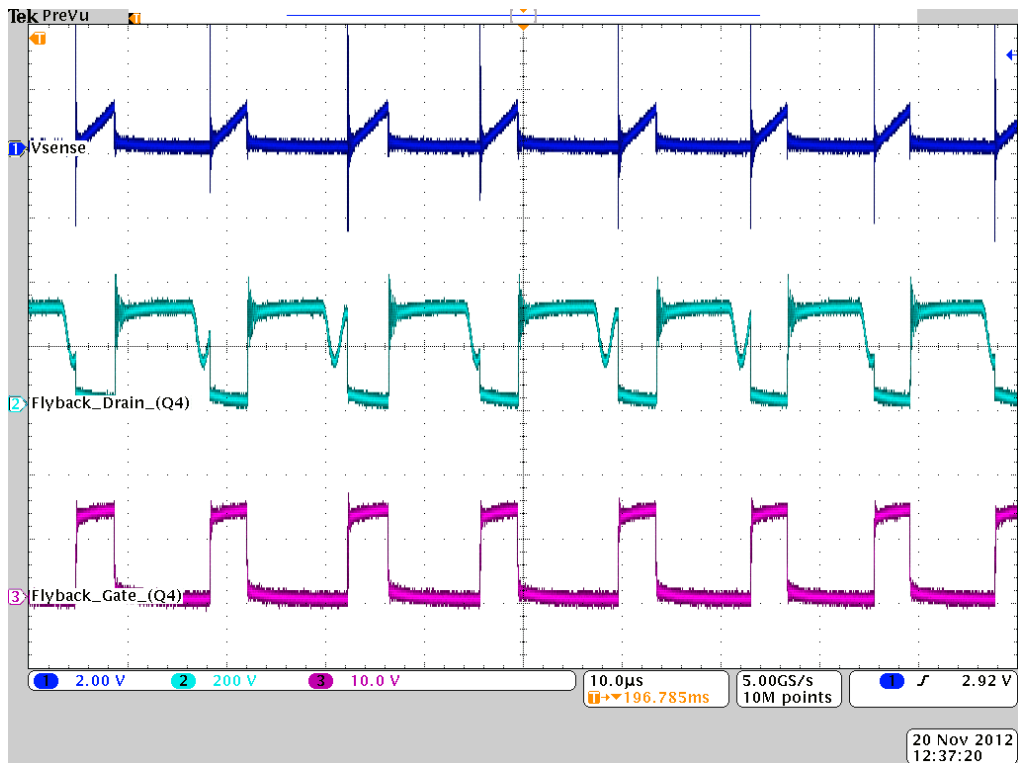

Figure 20. Flyback FET Q4 Waveform

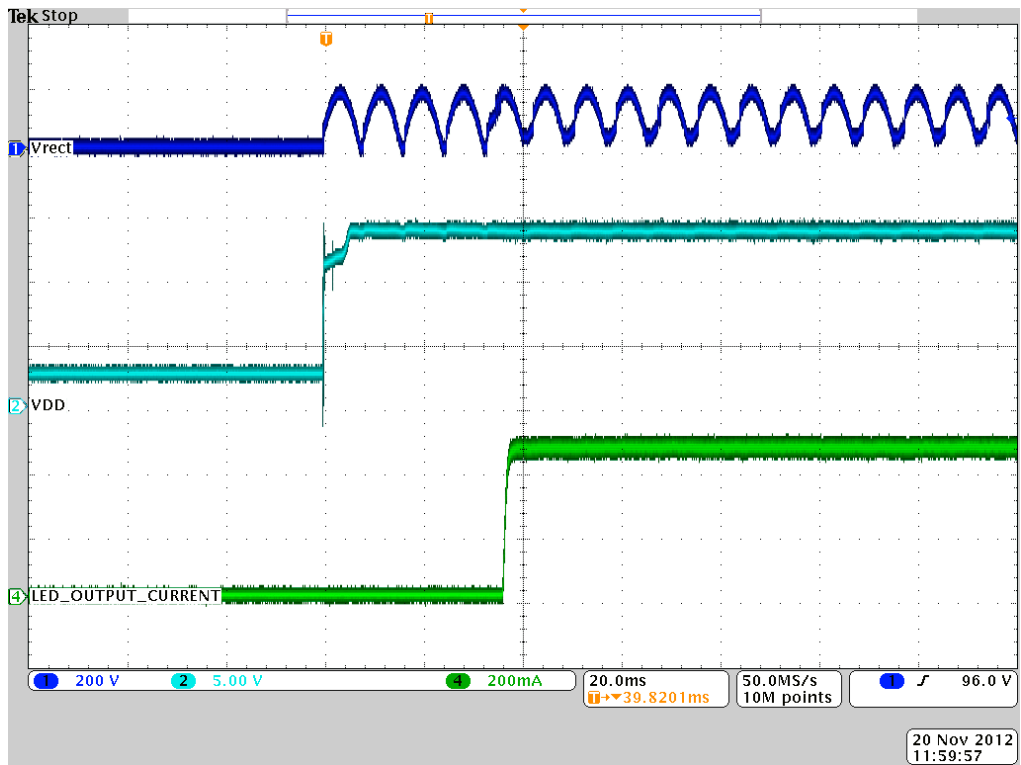

Figure 21. ILED at Maximum Dim Angle, Turn-on Waveforms

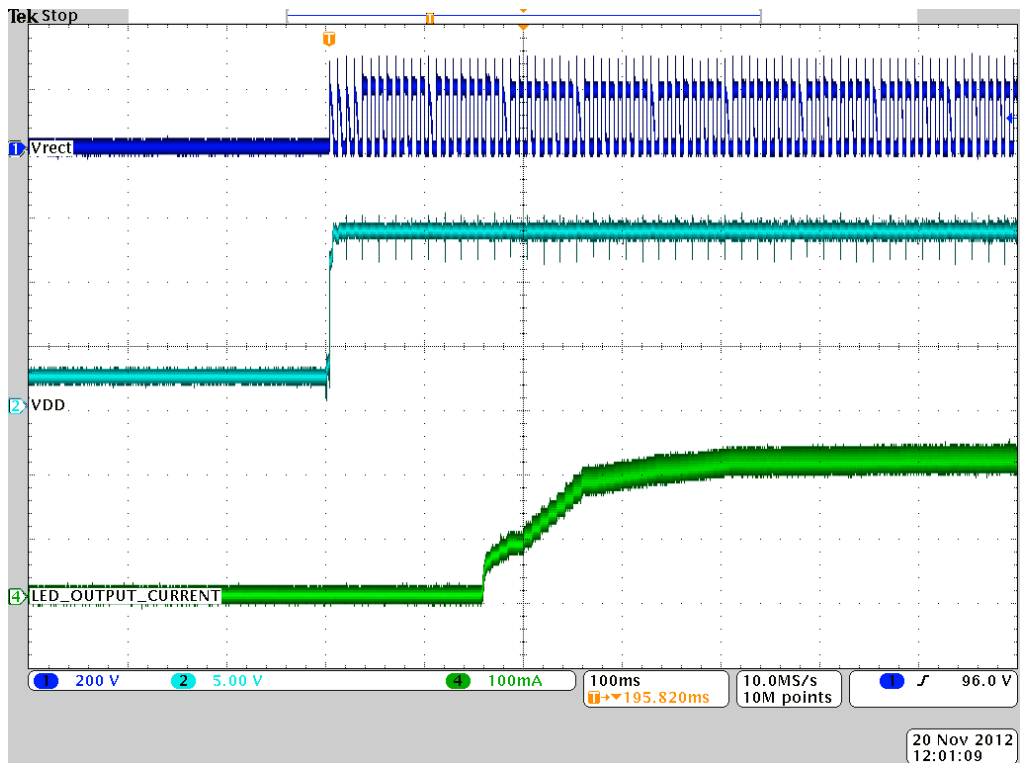

Figure 22. ILED at Medium Dim Angle, Turn-on Waveforms

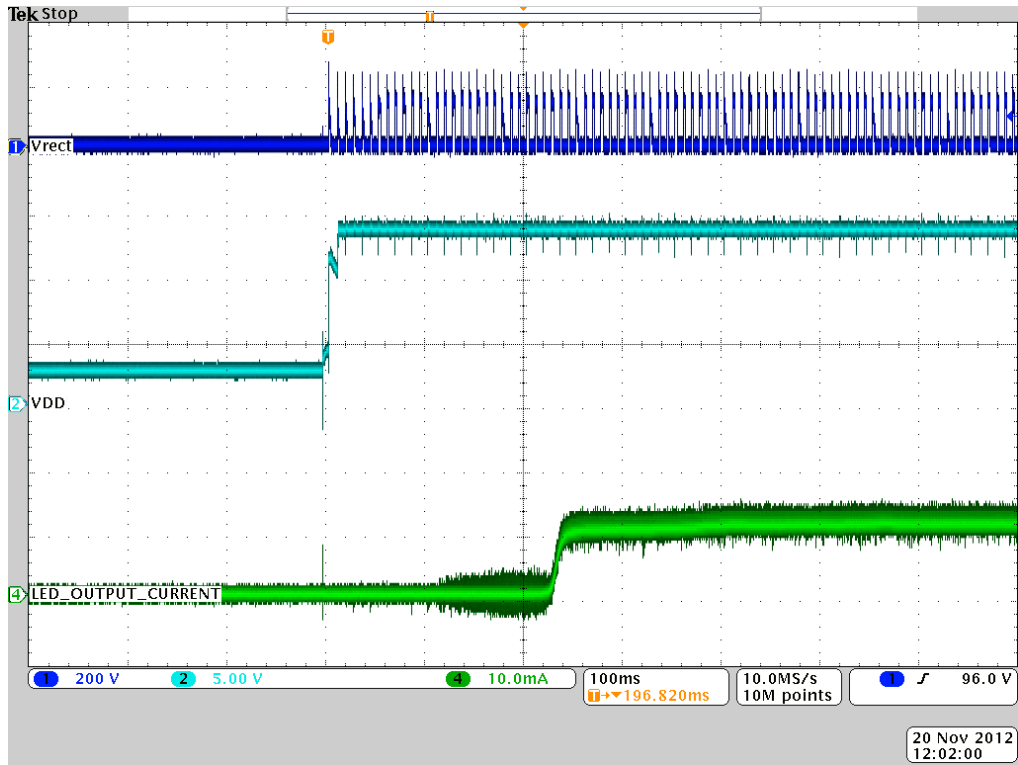

Figure 23. ILED at Minimum Dim Angle, Turn-on Waveforms

9. CONDUCTED EMI
Device Under Test: CRD1610A-8W-Z

Operating Conditions: NOMNIAL

Test Specification: IEC 55015

Operator Name: JCM

Scan Settings (1 Range)

Frequencies			Receiver Settings			
Start	Stop	Step	Res BW	M-Time	Atten	Preamp
150kHz	30MHz	4.5kHz	9kHz (6dB)	50ms	Auto	Off

Final Measurement
Detectors: QP, AV

Peaks: 10

Meas Time: 1s

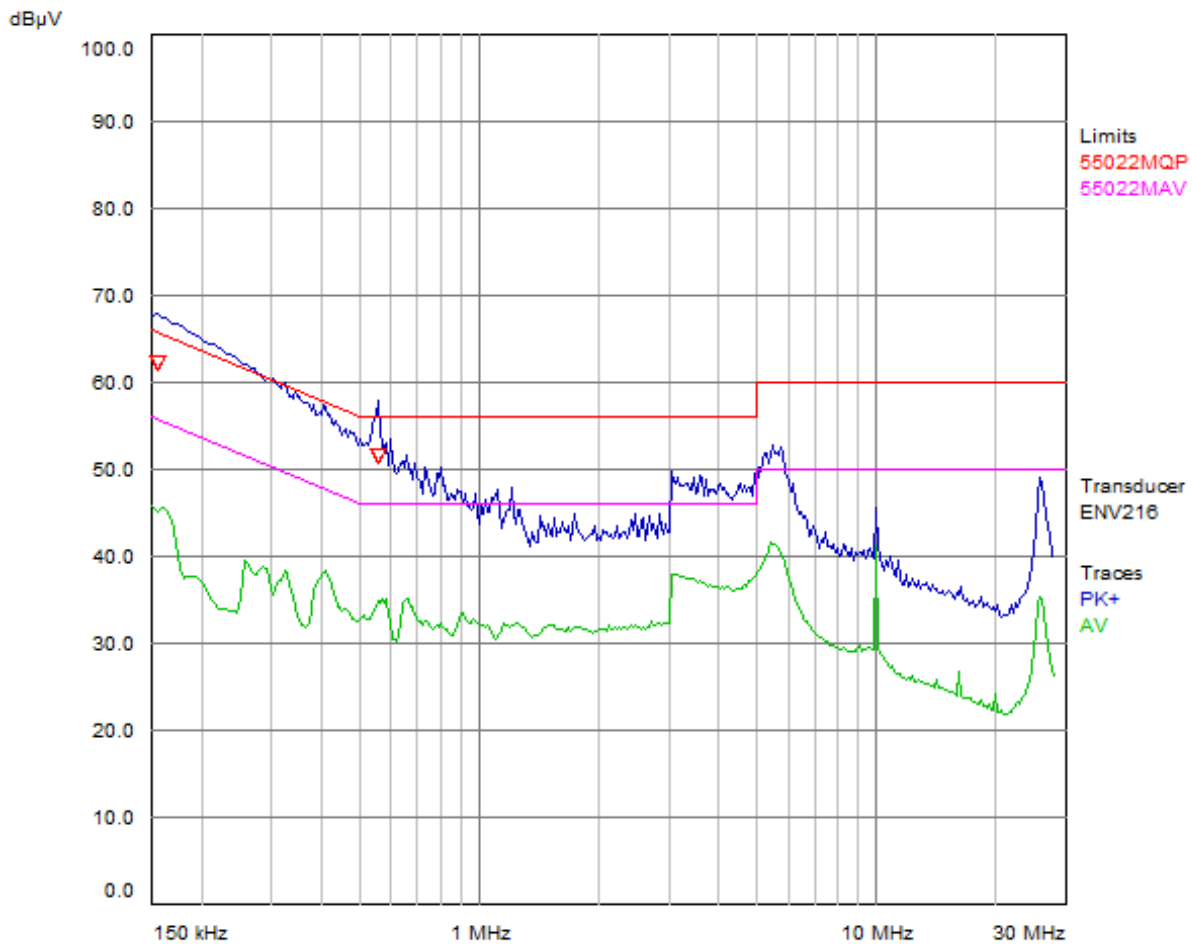
Acc. Margin: 3dB

Figure 24. Conducted EMI
Final Measurement Results

Trace	Frequency (MHz)	Level (dBµV)	Limit (dBµV)	Delta Limit (dB)	Delta Ref (dB)	Comment
1QP	0.15	61.18	66.00	-4.82	Auto	L1/on

* = Limit Exceeded

10. REVISION HISTORY

Revision	Date	Changes
RD1	FEB 2013	Initial release
RD2	MAR 2013	Context clarification
RD3	SEP 2013	PCBA revision B content clarification