

LOC		DIST		REVISIONS			
AA	00	P	LTR	DESCRIPTION	DATE	DN	APVD
		B1		REVISED PER ECO-10-000444	19JAN10	KK	AEG

- MATERIAL:
HOUSING: GLASS FILLED POLYESTER; COLOR: BLACK.
CONTACT: PHOS BRONZE
- FINISH:
0.00038[.000015] MIN GOLD PLATE IN CONTACT AREA,
0.00254[.000100] MIN MATTE TIN LEAD ON SOLDER POSTS, ALL
OVER 0.00127[.000050] MIN NICKEL
- AMP LOGO, TE PART NUMBER, DATE CODE AND CSA LOGO INK
STAMPED WHITE (HOT STAMPED OR LAZER PRINTED) IN THE APPROXIMATE
AREA SHOWN, EITHER SIDE PERMISSABLE, WHEN HOUSING SIZE PERMITS
- DATUMS AND BASIC DIMENSIONS ESTABLISHED BY CUSTOMER
- 4 OUNCES OF COPPER REQUIRED
- ELECTRICAL PERFORMANCE OF THIS CONNECTOR IS DIRECTLY RELATED
TO THE VRM 9.0 POWER MODULE BOARD DESIGN AND MAY BE AFFECTED BY
CHANGES TO THAT DESIGN
- CONNECTOR PERFORMANCE IS BASED UPON INFORMATION FROM THE VRM 9.0
AND 9.1 MODULE BOARD DESIGN STANDARD
- CONNECTORS SHOWN ARE USED IN APPLICATIONS WITH VRM MODULES WEIGHING
UP TO 6 OUNCES. ALTERNATIVE CONNECTOR AND LATCHING METHOD IS AVAILABLE
FOR VRM MODULES WEIGHING 3 OUNCES AND LESS. CONSULT TYCO ELECTRONICS
ENGINEERING FOR ADDITIONAL INFORMATION
- KEEP OUT ZONE APPLIES TO BOTH SIDES OF PC BOARD (FRONT AND BACK)
- OBSOLETE PARTS: OBSOLETE CIS STREAMLINING PER D.RENAUD/D.SINISI
- OBSOLETE

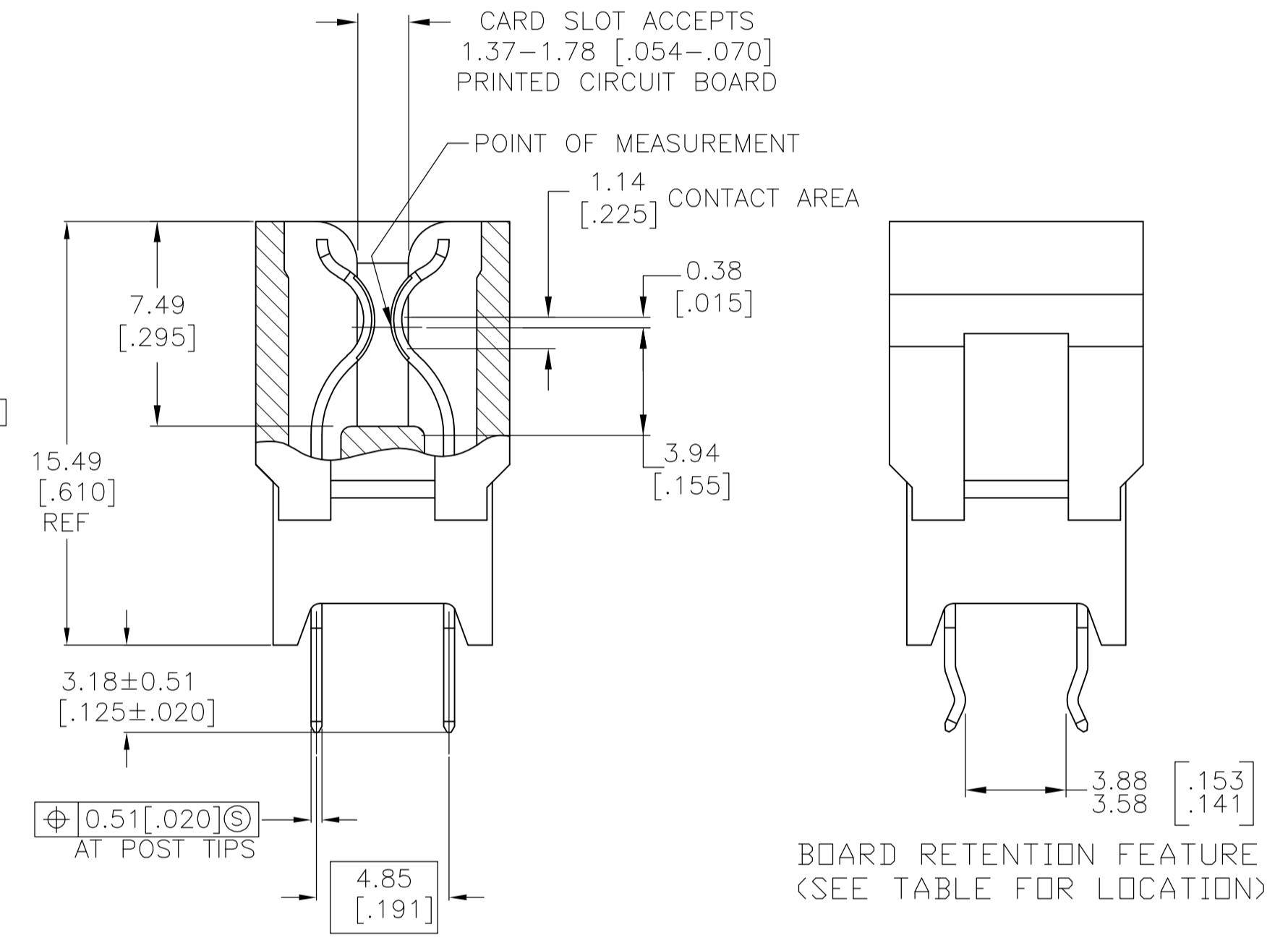
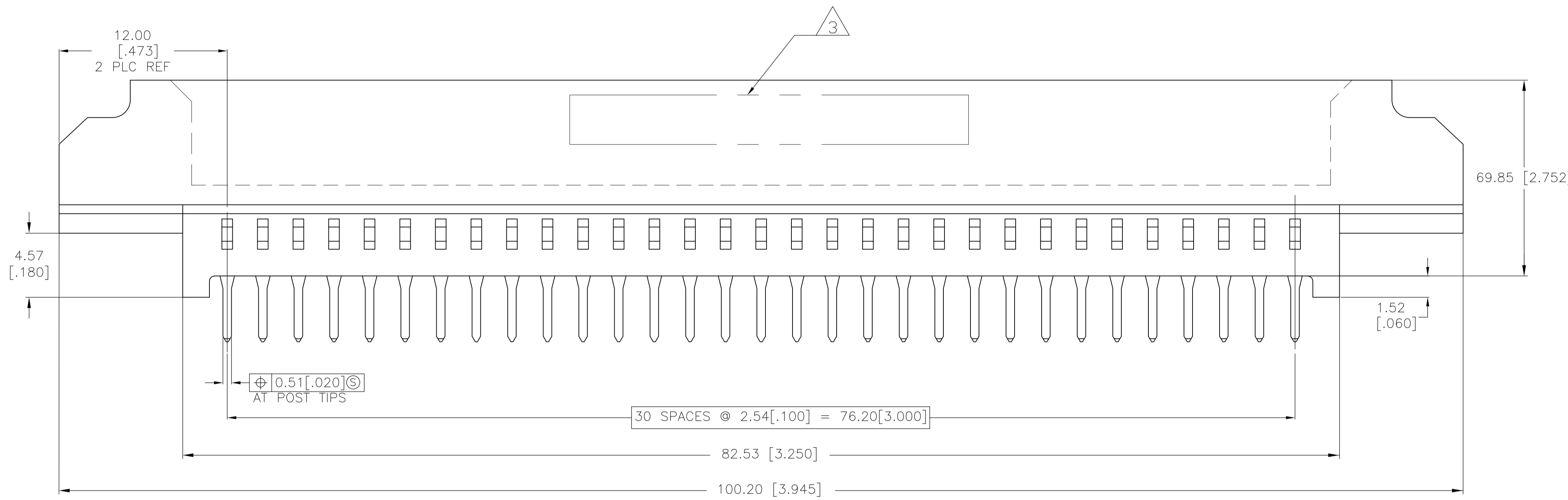
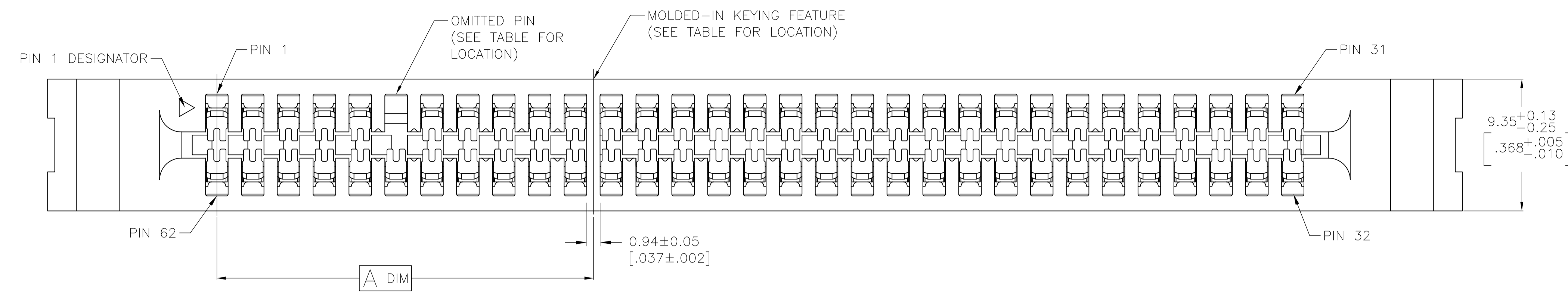

11	6364125-6
	6364125-5
	6364125-2
	PART NUMBER

10	OBSOLETE	2,3,29,30,33,34,60,61	+12V	55	7 & 8	62.06 [2.443]	18.87 [.743]	16.51 [.650]	31	6364125-4
		2,3,29,30,33,34,60,61	9.0, +12V	6	11 & 12	51.90 [2.043]	29.03 [1.143]	26.67 [1.050]	31	6364125-1
		RETENTION FEATURE LOCATION	VRM DESIGNATION	OMITTED PIN AND HOLE	MOLDED-IN KEYING FEATURE LOCATED BETWEEN PINS	E	D	A	NO OF DUAL POSITIONS	PART NUMBER

THIS DRAWING IS A CONTROLLED DOCUMENT.

DIMENSIONS: MM [INCHES]	TOLERANCES UNLESS OTHERWISE SPECIFIED:	DIN 31MAR2008 M.B./L.A.MAYER	Tyco Electronics Corporation Harrisburg, PA, 17105-3608
0 PLC ± -	1 PLC ± -	AWFRANTUM	31MAR2008
2 PLC ± 0.25 [01]	3 PLC ± -	S.FLICKINGER	31MAR2008
4 PLC ± -	ANGLES ± α	NAME	CONNECTOR ASSEMBLY, STANDARD EDGE II, 31 DUAL POSITION 2.54 [100] CENTERLINE
MATERIAL SEE NOTE 1	FINISH SEE NOTE 2	PRODUCT SPEC 108-9039-1	SIZE CASE CODE DRAWING NO 114-13018
		APPLICATION SPEC 114-13018	RESTRICTED TO A1 00779 ©=6364125
		WEIGHT	CUSTOMER DRAWING SCALE 5:1 SHEET 1 OF 3 REV B1

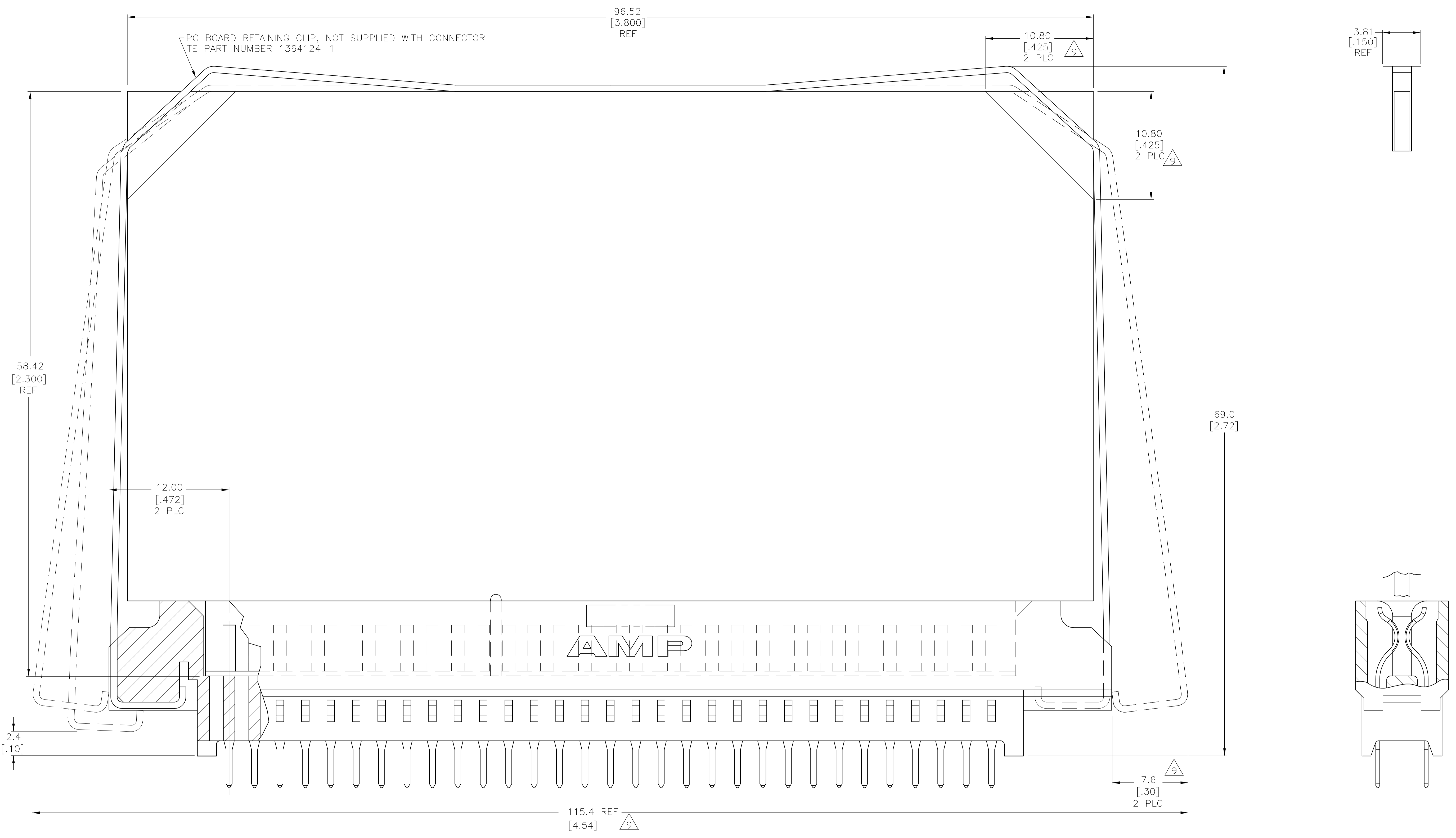

THIS DRAWING IS A CONTROLLED DOCUMENT.		DIN M.B./L.A.MAYER 31MAR2008	Tyco Electronics Corporation Harrisburg, PA, 17105-3608	
DIMENSIONS: MM [INCHES]		CHK A.W.FRANTUM 31MAR2008	NAME S.FLICKINGER	
TOLERANCES UNLESS OTHERWISE SPECIFIED:		PRODUCT SPEC		
0 PLC ± -		108-9039-1		
1 PLC ± -		APPLICATION SPEC		
2 PLC ± 0.25 [.01]		114-13018		
3 PLC ± -		SIZE CAGE CODE DRAWING NO		
4 PLC ± -		A1 00779 C=6364125		
ANGLES ± ± °		RESTRICTED TO		
MATERIAL SEE NOTE 1	FINISH SEE NOTE 2	WEIGHT -	CUSTOMER DRAWING	
		SCALE 5:1	SHEET 2 OF 3	REV B1

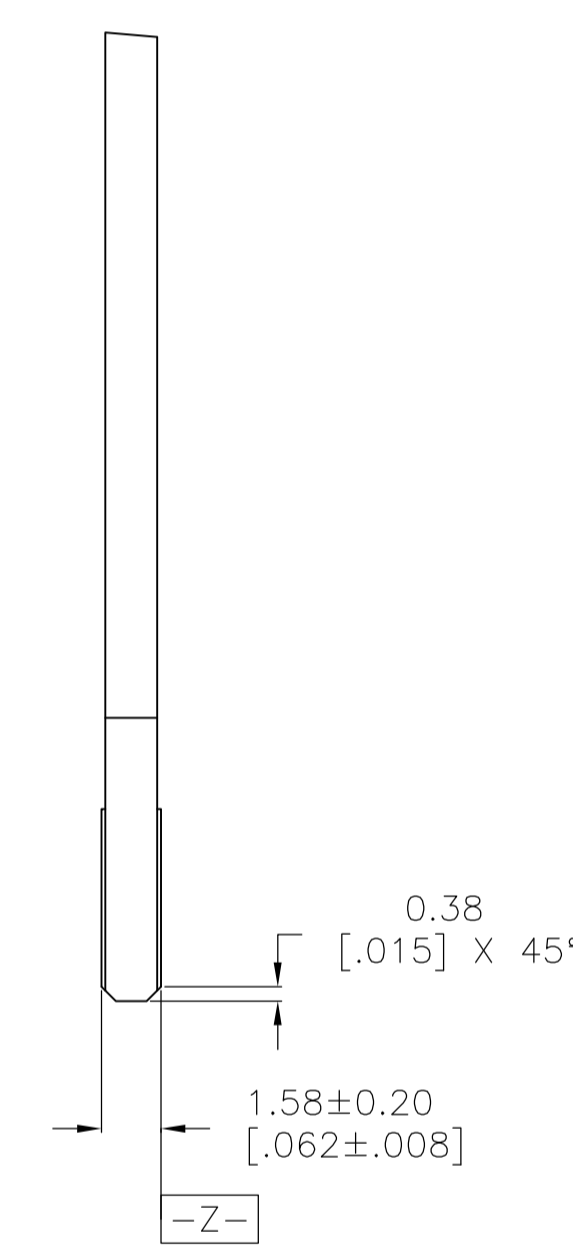
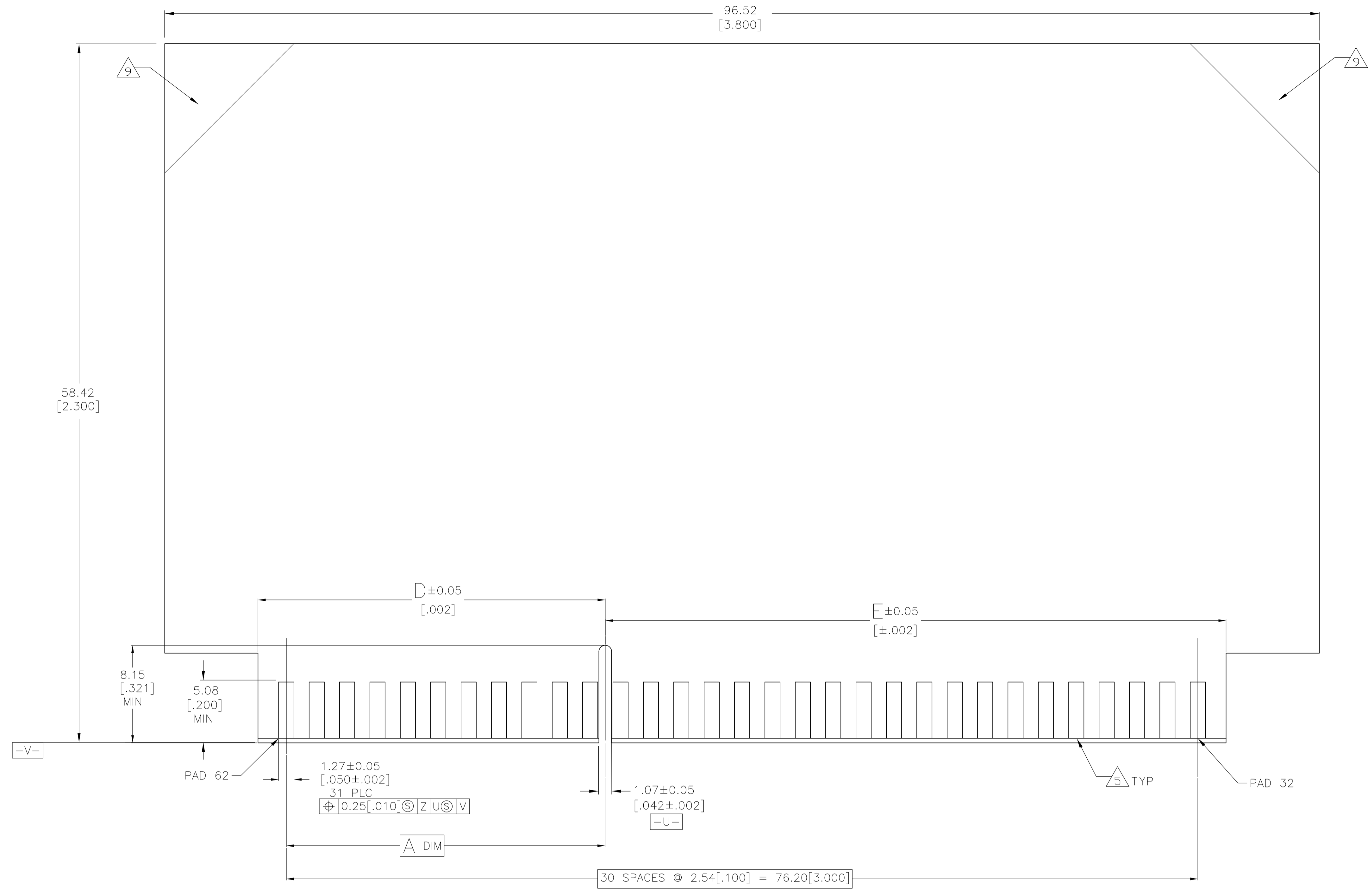

RECOMMENDED MATING BOARD EDGE CONFIGURATION

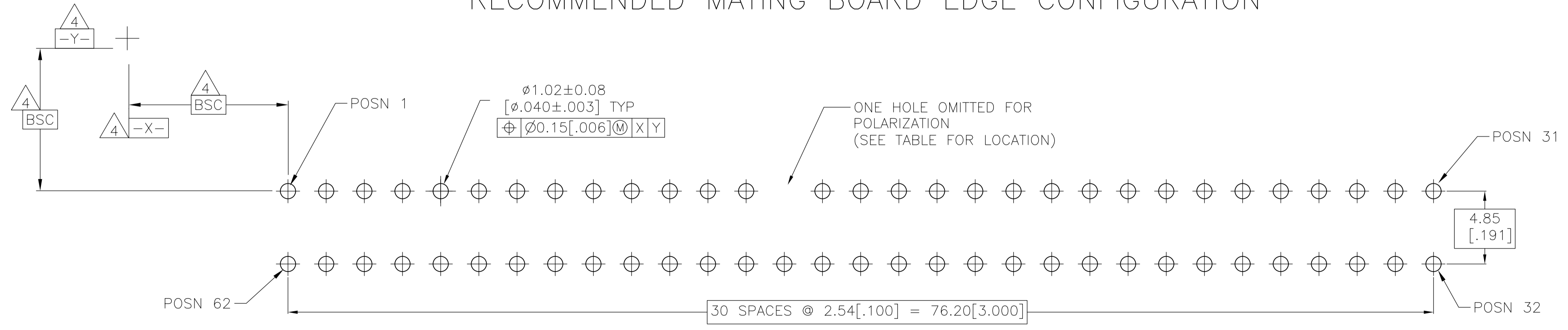

RECOMMENDED PC BOARD HOLE LAYOUT

THIS DRAWING IS A CONTROLLED DOCUMENT.		DIN M.B./L.A.MAYER 31MAR2008	Tyco Electronics Corporation Harrisburg, PA, 17105-3608	
DIMENSIONS: MM [INCHES]		CHK A.W.FRANTUM 31MAR2008	Tyco Electronics	
TOLERANCES UNLESS OTHERWISE SPECIFIED:		APVD S.FLICKINGER 31MAR2008	NAME	
0 PLC ± -		CONNECTOR ASSEMBLY, STANDARD EDGE II, 31 DUAL POSITION		
1 PLC ± -		2.54 [.100] CENTERLINE		
2 PLC ± 0.25 [.01]		PRODUCT SPEC 108-9039-1		
3 PLC ± -		APPLICATION SPEC		
4 PLC ± -		SIZE 114-13018		
ANGLES ± ± °		WEIGHT -		
MATERIAL SEE NOTE 1	FINISH SEE NOTE 2	SCALE 5:1	DRAWING NO. A1 00779	RESTRICTED TO
CUSTOMER DRAWING		SCALE 5:1	DRAWING NO. C=6364125	REV B1