

STRADA-SQ-VSM

IESNA Type V (square) beam for wide areas lighting such as car parks. Version with location pins.

TECHNICAL SPECIFICATIONS:

Dimensions	25 x 25 mm
Height	6.8 mm
Fastening	glue, pin, screw
Colour	clear
Box size	480 x 280 x 300 mm
Box weight	7.3 kg
Quantity in Box	2058 pcs
ROHS compliant	yes 



MATERIAL SPECIFICATIONS:

Component	Type	Material	Colour
STRADA-SQ-VSM	Lens	PMMA	clear

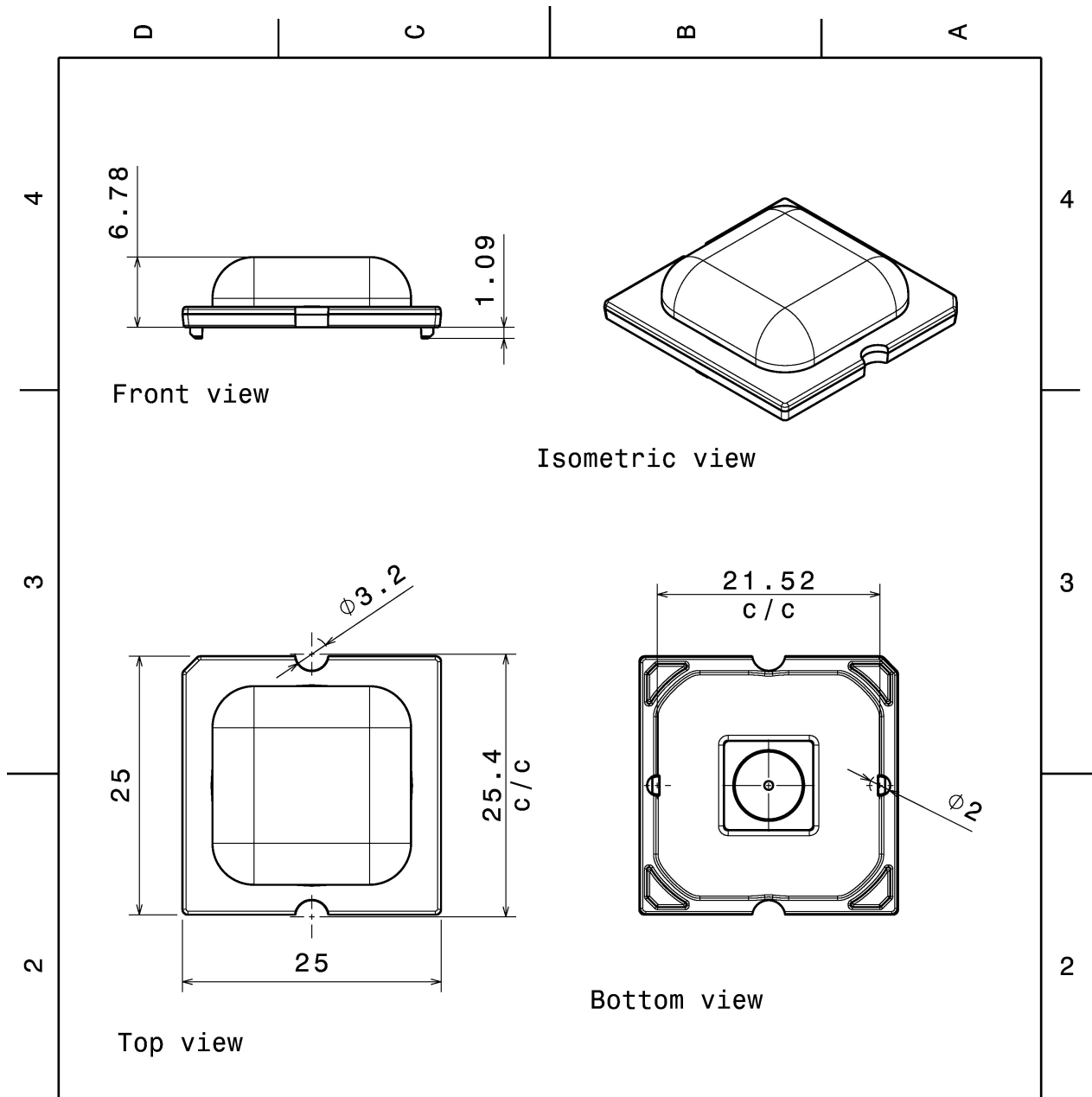

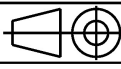
INDEX	PART NO	DESCRIPTION	MATERIAL	COLOUR
1	C12727	STRADA-SQ-VSM	PMMA	clear
<p>Tolerances if not otherwise shown According to DIN ISO 2768-1 Linear measures: class C According to DIN ISO 2768-2 Form and position: class L</p>		<p>LEDiL LediL Oy Salorankatu 10 FIN 24240 SALO Finland</p>		
<p>THIRD ANGLE PROJECTION:</p> 		<p>DRAWING TITLE C12727_STRADA-SQ-VSM</p>		
<p>This drawing is the property of LEDiL Oy. It may not be reproduced, copied or communicated without a written agreement with LEDiL Oy.</p>		<p>SIZE PART NUMBER A4 C12727</p>		
<p>SCALE 2:1</p>		<p>WEIGHT 2,45 g</p>		<p>SHEET 1/1</p>

PHOTOMETRIC DATA (MEASURED):



LED XHP50
 FWHM 154.0°
 Efficiency 94 %
 Peak intensity 0.330 cd/lm
 Required components:

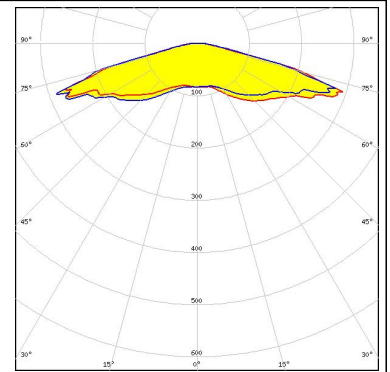
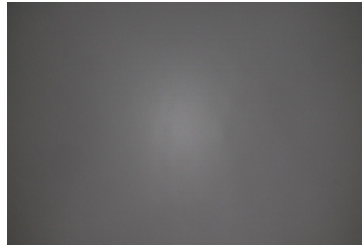

LED XM-L
 FWHM 154.0°
 Efficiency 93 %
 Peak intensity 0.200 cd/lm
 Required components:

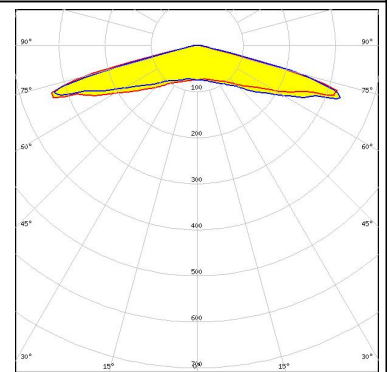

LED XM-L2
 FWHM 155.0°
 Efficiency 94 %
 Peak intensity 0.400 cd/lm
 Required components:

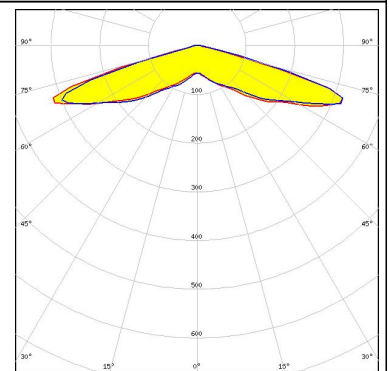

LED XP-E2
 FWHM 149.0°
 Efficiency 94 %
 Peak intensity 0.800 cd/lm
 Required components:

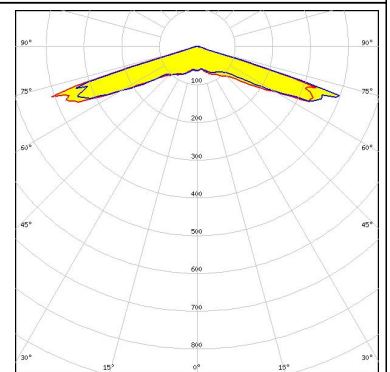
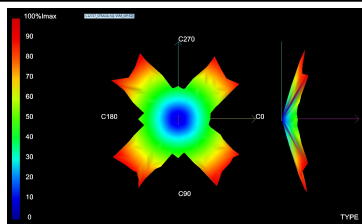

PHOTOMETRIC DATA (MEASURED):

CREE ⇄

LED XP-G2
FWHM 149.0°
Efficiency 94 %
Peak intensity 0.700 cd/lm
Required components:

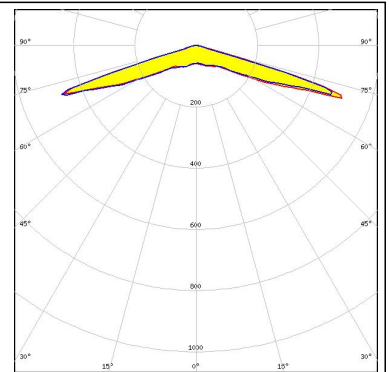

CREE ⇄

LED XP-L
FWHM 152.0°
Efficiency 94 %
Peak intensity 0.480 cd/lm
Required components:

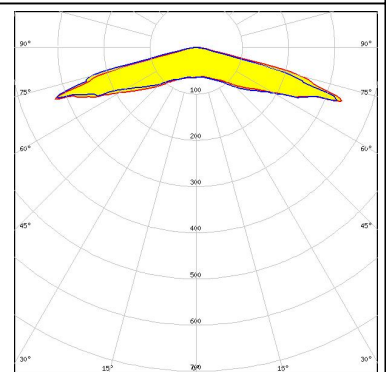
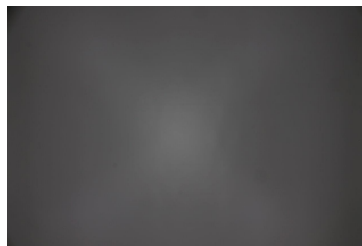

CREE ⇄

LED XP-L2
FWHM 149.0°
Efficiency 94 %
Peak intensity 0.400 cd/lm
Required components:

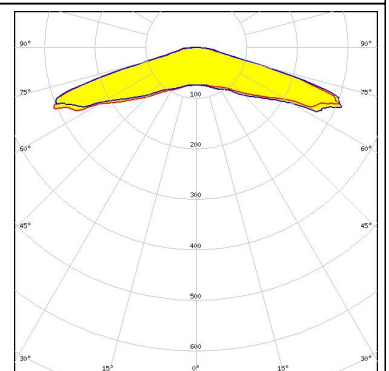

CREE ⇄

LED XT-E
FWHM 151.0°
Efficiency 93 %
Peak intensity 0.200 cd/lm
Required components:

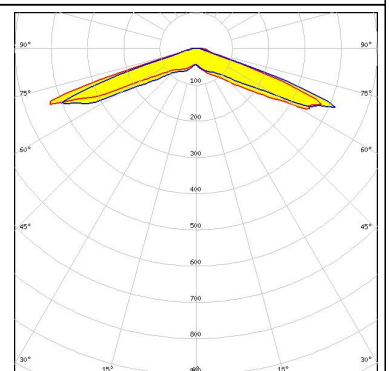

PHOTOMETRIC DATA (MEASURED):



LED H35C1 (LEMWA33)
 FWHM 151.0°
 Efficiency 94 %
 Peak intensity 0.670 cd/lm
 Required components:

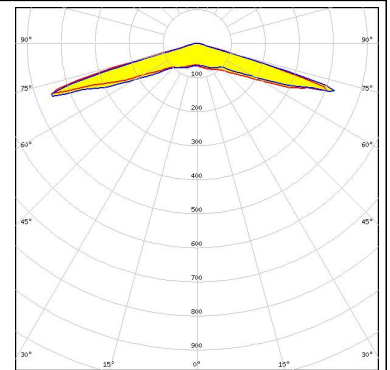
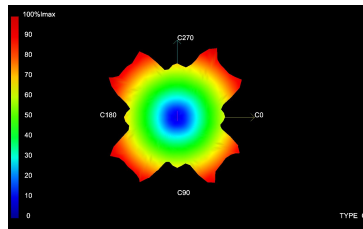

LED LUXEON M/MX
 FWHM 154.0°
 Efficiency 93 %
 Peak intensity 0.250 cd/lm
 Required components:

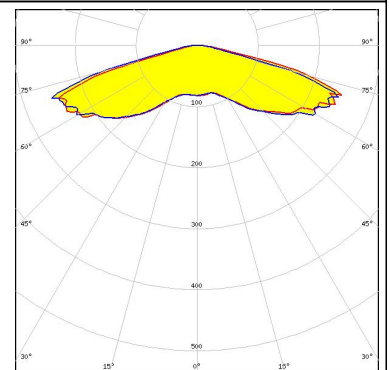

LED LUXEON MZ
 FWHM 148.0°
 Efficiency 94 %
 Peak intensity 0.410 cd/lm
 Required components:

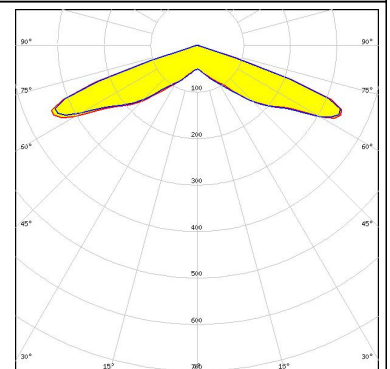
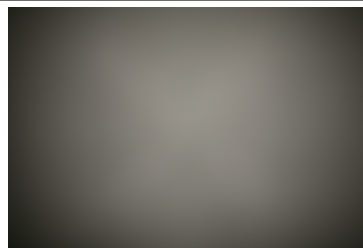

LED NFMW48xA
 FWHM 148.0°
 Efficiency 94 %
 Peak intensity 0.390 cd/lm
 Required components:

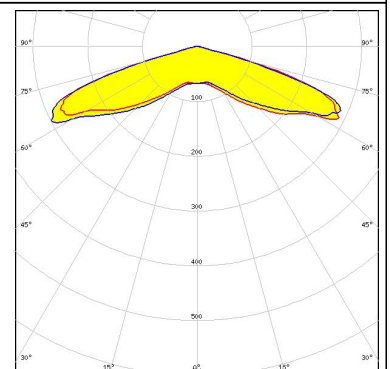

PHOTOMETRIC DATA (SIMULATED):



LED LUXEON 5050
FWHM 150.0°
Efficiency 94 %
Peak intensity 0.410 cd/lm
Required components:

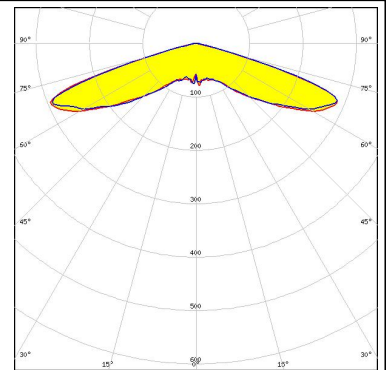

LED OSCONIQ P 7070
FWHM 150.0°
Efficiency 90 %
Peak intensity 0.357 cd/lm
Required components:

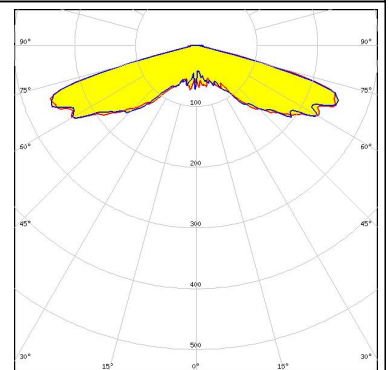

LED Oslon Square Gen3
FWHM 144.0°
Efficiency 98 %
Peak intensity cd/lm
Required components:

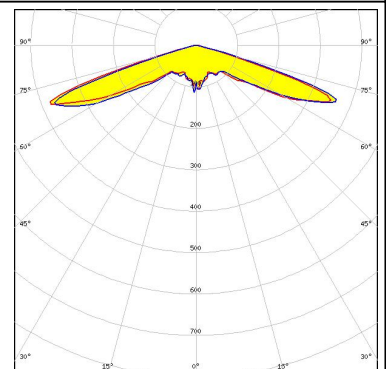

GENERAL INFORMATION:

NOTE: The typical beam angle will be changed by different color, chip size and chip position tolerance. The typical total beam angle is the full angle measured where the luminous intensity is half of the peak value.

MATERIALS:

As part of our continuous research and improvement processes, and to ensure the best possible quality and availability of our products, LEDiL reserves the right to change material grades without notice.

PRODUCT DATA USER AGREEMENT AND DISCLAIMER:

The measured data in the provided downloadable LEDiL Product Datasheets and Mechanical 2D-Drawings is rounded and provided as reference for planning. LEDiL Oy's optical specifications have been verified by conducting performance testing of the products in accordance with the company's quality system. The reported data are averaged results of multiple measurements with typical variation. LEDiL Oy reserves the right to without prior notification make changes and improvements to its products.

LEDiL Oy assumes neither warranty, nor guarantee nor any other liability of any kind for the contents and correctness of the provided data. The provided data has been generated with highest diligence but the provided data may in reality not represent the complete possible variation range of all intrinsic parameters. Therefore, in certain cases a deviation from the provided data could occur.

LEDiL Oy reserves the right to undertake technical changes of its products without further notification which could lead to changes in the provided data. LEDiL Oy assumes no liability of any kind for the possible deviation from any provided data or any other damage resulting from the usage of the provided data.

The user agrees to this disclaimer and user agreement with the download or usage of the provided files.

LEDiL Oy

Joensuunkatu 13
FI-24240 SALO
Finland

LEDiL Inc.

228 West Page Street
Suite D
Sycamore IL 60178
USA

Local sales and technical support

[www.ledil.com/
where_to_buy](http://www.ledil.com/where_to_buy)

Shipping locations

Salo, Finland
Hong Kong, China

Distribution Partners

[www.ledil.com/
where_to_buy](http://www.ledil.com/where_to_buy)