



DC-UPS WITH INTEGRATED BATTERY

- Compact and Easy to Install
- Longest Buffer Time in Class
- Easy Battery Access
- Stable Output Voltage in Buffer Mode
- Superior Battery Management for Longest Battery Life
- Temperature Compensated Battery Charging
- Comprehensive Diagnostics and Monitoring Functions
- Replace Battery Signal Included
- Electronically Overload and Short Circuit Protected
- 50% Power Reserves
- Selectable Buffer Time Limiter

1. GENERAL DESCRIPTION

This uninterruptible power supply (UPS) controller UBC10.241 with integrated battery is a compact addition to standard 24V power supplies to bridge power failures or voltage fluctuations. Expensive downtimes, long restart cycles and loss of data can be avoided.

The DC-UPS includes a professional battery management system which charges and monitors the battery to achieve the longest battery service life as well as many diagnostic functions that ensure a reliable operation of the entire system.

A unique feature of the UBC10.241 is that only one 12V battery is required to buffer the 24V output. This makes matching batteries unnecessary and allows a precise battery charging and testing.

The UBC10.241 has one integrated 12V 5Ah high current VRLA battery, which is easy to change.

In addition to the UBC10.241, a separate UPS controller (UB10.241) which requires an external 12V battery is available when a longer buffer time is required.

2. SHORT-FORM DATA

Input voltage	nom. 24Vdc	
range	22.5-30Vdc	
Output current	min. 15A	Normal mode
	min. 10A	Buffer mode
Output voltage	typ. 0.23V lower as input voltage	Normal mode
	22.25V	Buffer mode, 10A
Integrated battery	12V 5Ah	VRLA lead acid
Temperature range	0 to 40°C	Operational
Dimensions	123x124x119mm	WxHxD
Buffer time	typ. 16'15"	At 5A load
	typ. 6'15"	At 10A load

Typical setup of a DC-UPS system with the UBC10.241:

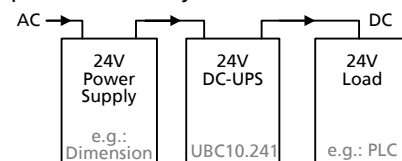

3. ORDER NUMBERS

DC-UPS	UBC10.241	Standard unit
	UBC10.241-N1	Battery not assembled
Accessories	UZH12.051	Battery 12V 5Ah

4. MARKINGS



Jul. 2014 / Rev. 1.2 DS-UBC10.241-EN

All parameters are specified at an input voltage of 24V, 10A output load, 25°C ambient and after a 5 minutes run-in time unless otherwise noted. It is assumed that the input power source can deliver a sufficient output current.

INDEX PAGE

1. General Description	1
2. Short-form Data	1
3. Order Numbers	1
4. Markings	1
5. Input	3
6. Output in Normal Mode	4
7. Output in Buffer Mode	5
8. Battery Input	6
9. Buffer Time	7
10. Efficiency and Power Losses	8
11. Functional Diagram	8
12. Check Wiring and Battery Quality Tests	9
13. Relay Contacts and Inhibit Input	10
14. Front Side User Elements	12
15. Terminals and Wiring	13
16. Reliability	13

INDEX PAGE

17. EMC	14
18. Environment	15
19. Protection Features	15
20. Safety	16
21. Approvals	16
22. Fulfilled Standards	16
23. Used Substances	17
24. Physical Dimensions and Weight	17
25. Installation Notes	18
26. Replacement of the battery	19
27. Accessories	20
28. Application Notes	21
28.1. Battery Replacement Intervals	21
28.2. Parallel and Serial Use	22
28.3. Using the Inhibit Input	23
28.4. Troubleshooting	23

INTENDED USE

The unit shall only be installed and put into operation by qualified personnel.

This unit is designed for installation in an enclosure and is intended for general use, such as in industrial control, office, communication, and instrumentation equipment. Do not use this device in aircraft, trains and nuclear equipment, where malfunctioning of the power supply may cause severe personal injury or threaten human life.

TERMINOLOGY AND ABBREVIATIONS

DC-UPS	Uninterruptible power supply with DC-Input.
Normal mode	Describes a condition where the battery is charged, the input voltage is in range and the output is loaded within the allowed limits.
Buffer mode	Describes a condition where the input voltage is below the transfer threshold level, the unit is running on battery (buffering) and the output is loaded within the allowed limits.
Charging mode	Describes a condition where the battery is being charged, the input voltage is in range and the output is loaded within the allowed limits.
Inhibit mode	Describes a condition where buffering is disabled on purpose by using the inhibit input of the DC-UPS. (e.g. for service actions, or to save battery capacity)
Buffer time	Same as the term "hold-up time".
T.b.d.	To be defined, value or description will follow later.

DISCLAIMER

The information presented in this document is believed to be accurate and reliable and may change without notice. Some parts of this unit are patent by PULS (US patent No 091662,063, Des. 424,529, ...).

No part of this document may be reproduced or utilized in any form without permission in writing from the publisher.

5. INPUT

Input voltage	nom.	DC 24V	
Input voltage ranges	nom.	22.5 to 30Vdc 30 to 35Vdc 35Vdc 0 to 22.5Vdc	Continuous operation, see Fig. 5-1 Temporarily allowed, no damage to the DC-UPS *) Absolute maximum input voltage with no damage to the DC-UPS The DC-UPS switches into buffer mode and delivers output voltage from the battery if the input was above the turn-on level before and all other buffer conditions are fulfilled.
Allowed input voltage ripple	max.	1.5Vpp 1Vpp	Bandwidth <400Hz Bandwidth 400Hz to 1kHz
Allowed voltage between input and earth (ground)	max.	60Vdc or 42.4Vac	
Turn-on voltage	typ.	22.8Vdc	The output does not switch on if the input voltage does not exceed this level.
	max.	23Vdc	
Input current **)	typ.	120mA	Internal current consumption
	typ.	1.1A	Current consumption for battery charging in constant current mode at 24V input See Fig. 8-2 ***)
External capacitors on the input		No limitation	

*) The DC-UPS shows "Check Wiring" with the red LED and buffering is not possible

**) The total input current is the sum of the output current, the current which is required to charge the battery during the charging process and the current which is needed to supply the DC-UPS itself. See also Fig. 5-2. This calculation does not apply in overload situations where the DC-UPS limits the output current, therefore see Fig. 5-3.

***) Please note: This is the input current and not the current which flows into the battery during charging. The battery current can be found in chapter 8.

Fig. 5-1 Input voltage range

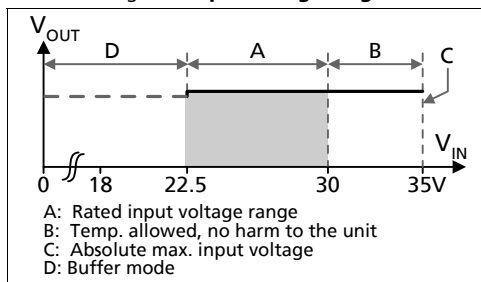
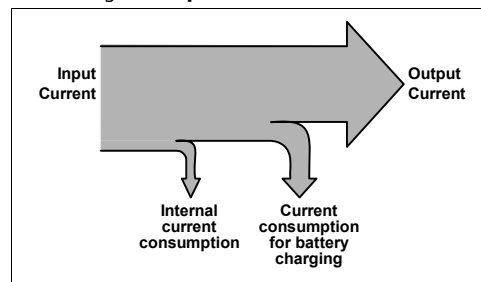

Fig. 5-2 Input current, definitions



Electronic output current limitation

The DC-UPS is equipped with an electronic output current limitation. This current limitation works in a switching mode which reduces the power losses and heat generation to a minimum. As a result, the output voltage drops since there is not enough current to support the load. A positive effect of the current limitation in switching mode is that the input current goes down despite an increase in the output current resulting in less stress for the supplying source.

Fig. 5-3 Input current and output voltage vs. output current, typ. (battery fully charged)

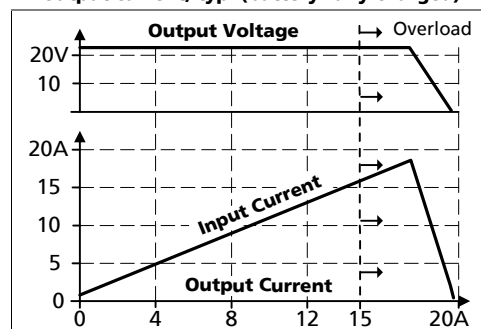

6. OUTPUT IN NORMAL MODE

Output voltage in normal mode	nom.	DC 24V	The output voltage follows the input voltage reduced by the input to output voltage drop.
Voltage drop between input and output	max.	0.3V	At 10A output current, see Fig. 6-1 for typical values
	max.	0.45V	At 15A output current, see Fig. 6-1 for typical values
Ripple and noise voltage	max.	20mVpp	20Hz to 20MHz, 50Ohm *)
Output current	nom.	15A	Continuously allowed
Output power	nom.	360W	Continuously allowed
Short-circuit current	min.	17.9A	Load impedance 100mOhm, see Fig. 6-2 for typical values
	max.	21A	Load impedance 100mOhm, see Fig. 6-2 for typical values
Capacitive and inductive loads	No limitation		

*) This figure shows the ripple and noise voltage which is generated by the DC-UPS. The ripple and noise voltage might be higher if the supplying source has a higher ripple and noise voltage.

Fig. 6-1 Input to output voltage drop, typ.

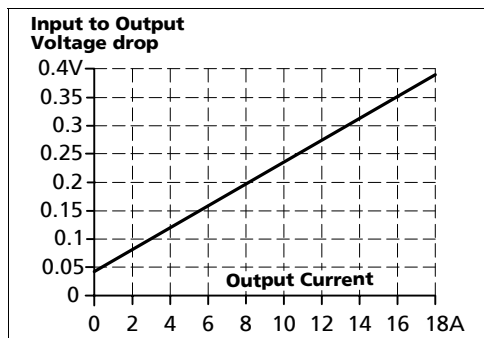
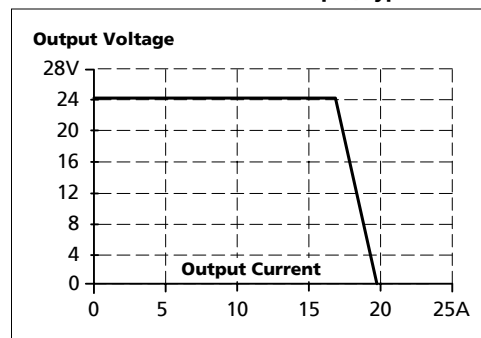

Fig. 6-2 Output voltage vs. output current in normal mode at 24V input, typ.



7. OUTPUT IN BUFFER MODE

If the input voltage falls below a certain value (transfer threshold level), the DC-UPS starts buffering without any interruption or voltage dips. Buffering is possible even if the battery is not fully charged.

Output voltage in buffer mode	nom.	DC 24V	Output voltage is stabilized and independent from battery voltage
		22.45V	±1%, at no load,
		22.25V	±1%, at 10A output current
Transfer threshold for buffering	typ.	80mV higher than the output voltage in buffer mode	
Ripple and noise voltage	max.	20mVpp	20Hz to 20MHz, 50Ohm
Output current	nom.	10A	Continuously allowed
		15A	< 5s with full output voltage *)
Short-circuit current	min.	17.9A	Load impedance 100mOhm **)
	max.	21A	Load impedance 100mOhm **)

- *) If the output current is in the range between 10A and 15A for longer than 5s, a hardware controlled reduction of the maximal output current to 10A occurs. If the 10A are not sufficient to maintain the 24V, buffering stops after another 5s. The buffering is possible again as soon as the input voltage recovers.
- ***) If the nominal output voltage cannot be maintained in buffer mode, the DC-UPS switches off after 5s to save battery capacity.

Fig. 7-1 Buffering transition, definitions

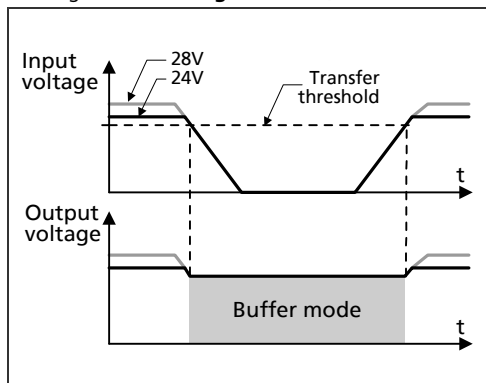

Fig. 7-2 Transfer behavior, typ.

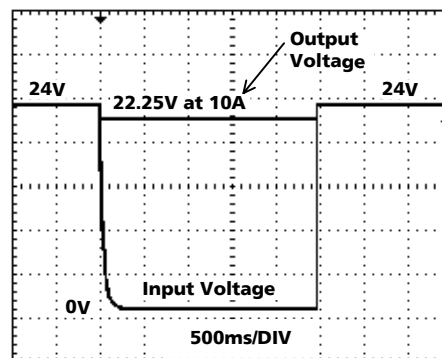

Fig. 7-3 Available output current in buffer mode

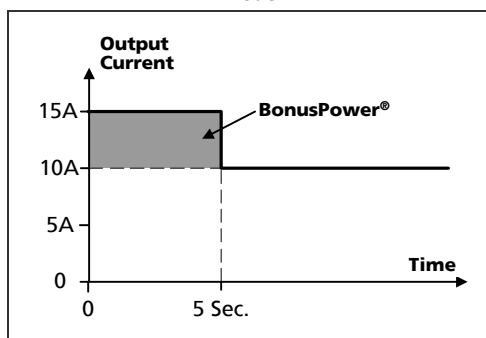
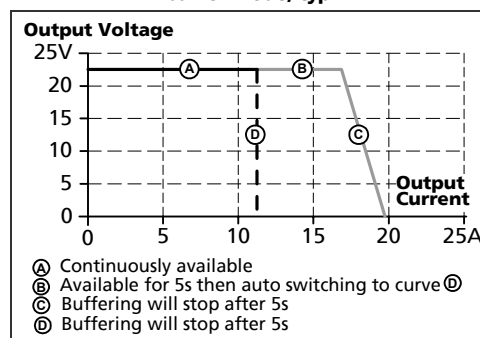

Fig. 7-4 Output voltage vs. output current in buffer mode, typ.



8. BATTERY

The required 12V VRLA battery is included with this unit. For more details on battery requirements see chapter 26.

Battery voltage	nom. DC 12V	Maintenance-free 12V VRLA lead acid battery.
Battery voltage range	9.0 – 15.0V	Continuously allowed, except deep discharge protection
	max. 35Vdc	Absolute maximum voltage with no damage to the unit.
	typ. 7.4V	Above this voltage level battery charging is possible
Allowed battery capacity	nom. 5Ah	High-current version
Battery charging method	CC-CV	Constant current, constant voltage mode
Battery charging current	nom. 1.5A	CC-mode, Independent from battery size
	max. 1.7A	Corresponding 24V input current see Fig. 8-2
End-of-charge-voltage (CV-mode)	typ. 13.1 - 14V	Automatic setting according to ambient temperature
Battery charging time	typ. 3h *)	
Battery discharging current **)	typ. 21A	Buffer mode, 10A output current, 11.5V on the battery terminal of the DC-UPS, see Fig. 8-1 for other parameters
	typ. 0.3A	Buffer mode, 0A output current
	max. 50µA	At no input, buffering had switched off, all LEDs are off
	typ. 270mA	At no input, buffering had switched off, yellow LED shows "buffer time expired" (max. 15 minutes)
Deep discharge protection ***)	typ. 10.5V	At 0A output current
	typ. 9.0V	At 10A output current

*) The charging time depends on the duration and load current of the last buffer event. The numbers in the table represent a fully discharged battery. A typical figure for a buffer current of 10A is 2h 20Min. for a 5Ah highcurrent battery. Above 40°C charging time can be longer.

***) The current between the battery and the DC-UPS is more than twice the output current. This is caused by boosting the 12V battery voltage to a 24V level.

***) To ensure longest battery lifetime, the DC-UPS has a battery deep discharge protection feature included. The DC-UPS stops buffering when the voltage on the battery terminals of the DC-UPS falls below a certain value.

Fig. 8-1 Battery discharging current vs. output current, typ.

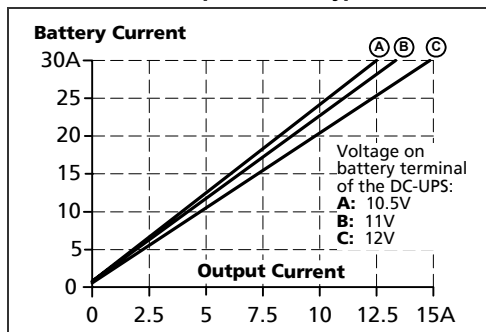
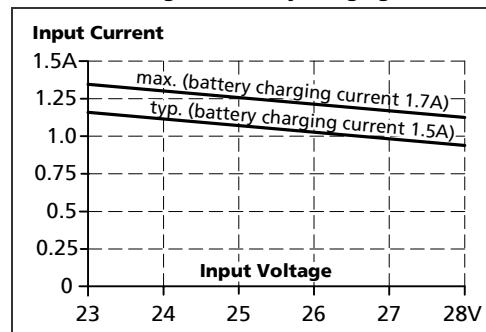

Fig. 8-2 Required input current vs. input voltage for battery charging



9. BUFFER TIME

The buffer time depends on the capacity and performance of the battery as well as the load current. The diagram below shows the typical buffer times of the standard battery.

Buffer time with 5Ah high-current battery	min.	13'24"	At 5A output current *)
	min.	4'54"	At 10A output current *)
	typ.	16'15"	At 5A output current, see Fig. 9-1 **)
	typ.	6'15"	At 10A output current, see Fig. 9-1 **)

*) Minimum value includes 20% aging and requires a fully charged (min. 24h) battery.

***) Typical value includes 10% aging and requires a fully charged (min. 24h) battery.

Fig. 9-1 Buffer time vs. output current with a 5Ah high current battery

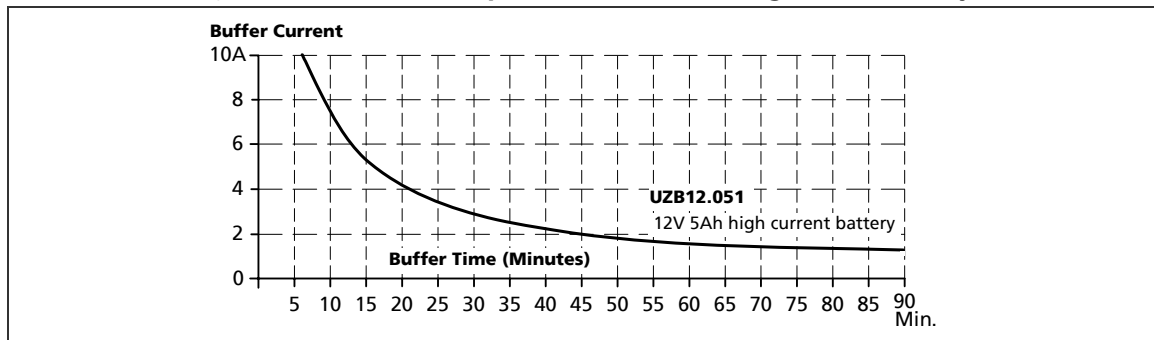

10. EFFICIENCY AND POWER LOSSES

Efficiency	typ.	97.8%	Normal mode, 10A output current, battery fully charged
Power losses	typ.	2.9W	Normal mode, 0A output current, battery fully charged
	typ.	5.5W	Normal mode, 10A output current, battery fully charged
	typ.	5.0W	During battery charging, 0A output current

Fig. 10-1 Efficiency at 24V, typ.

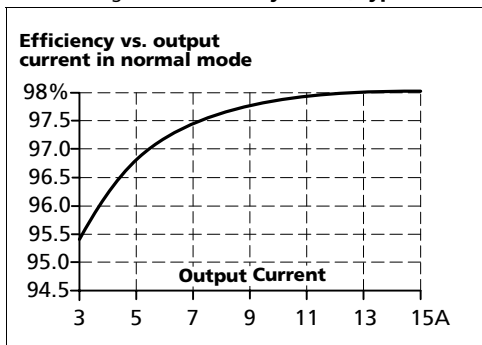
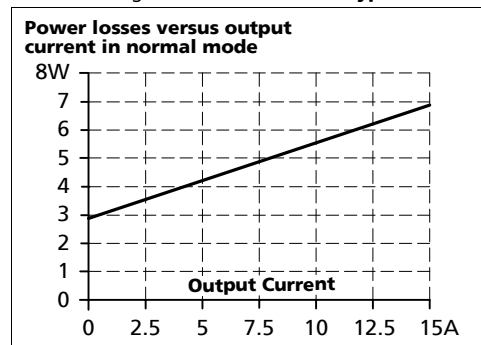
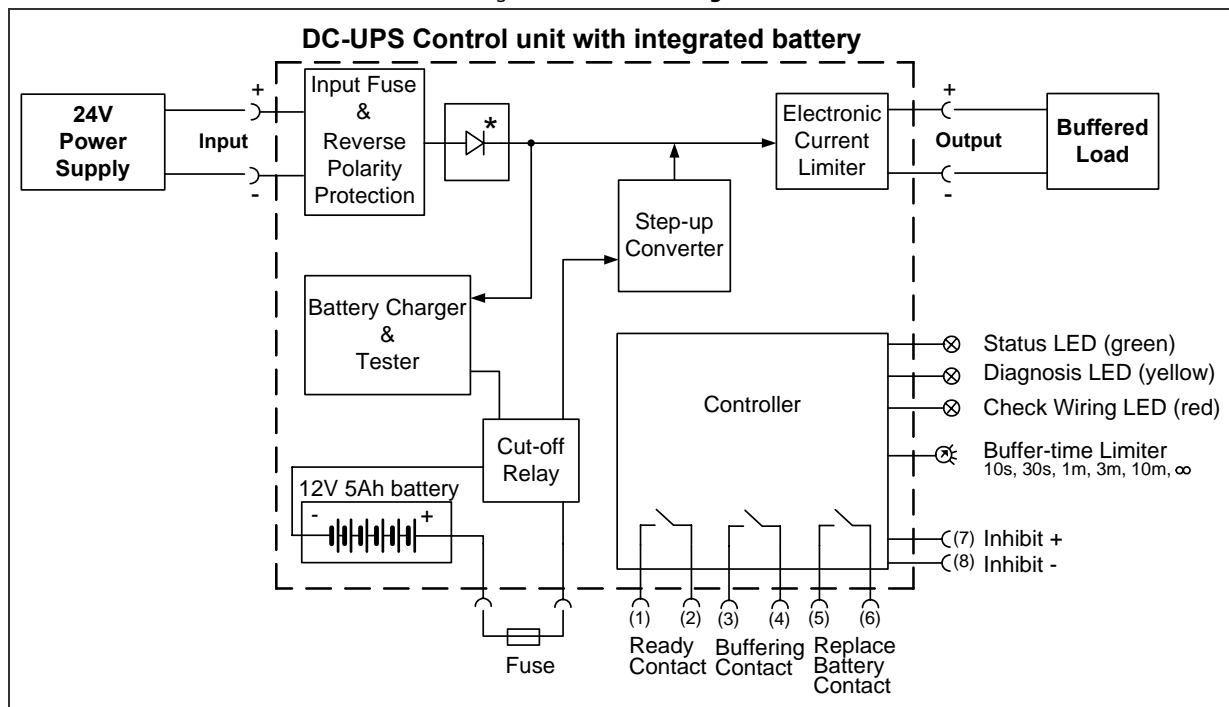

Fig. 10-2 Losses at 24V, typ.



11. FUNCTIONAL DIAGRAM

Fig. 11-1 Functional diagram



*) Return current protection; This feature utilizes a Mofet instead of a diode in order to minimize the voltage drop and power losses.

12. CHECK WIRING AND BATTERY QUALITY TESTS

The DC-UPS is equipped with an automatic "Check Wiring" and "Battery Quality" test.

"Check Wiring" test:

Under normal circumstances, an incorrect or bad connection from the battery to the DC-UPS or a missing (or blown) battery fuse would not be recognized by the UPS when operating in normal mode. Only when back up is required would the unit not be able to buffer. Therefore, a "check wiring" test is included in the DC-UPS. This connection is tested every 10 seconds by loading the battery and analyzing the response from the battery. If the resistance is too high, or the battery voltage is not in range, the unit displays "Check Wiring" with the red LED. At the same time the green "Ready" LED will turn off.

"State of Health" (SoH) test:

The battery has a limited service life and needs to be replaced in a fixed interval which is defined by the specified service life (acc. to the Eurobat guideline), based on the surrounding temperature and the number of charging/discharging cycles. If the battery is used longer than the specified service life, the battery capacity will degrade. Details can be found in chapter 28.1. SoH test can not determine a gradual loss in capacity. However, it can detect a battery failure within the specified service life of the battery. Therefore a SoH-test is included in the DC-UPS.

The SoH test consists of different types of tests:

- **During charging:**
If the battery does not reach the ready status (see chapter 14) within 30h, it is considered to be defective. The reason could be a broken cell inside the battery.
- **During operation:**
Once the battery is fully charged, a voltage drop test and a load test is performed alternately every 8 hours. Three of the tests must consecutively produce negative results to indicate a battery problem.

A battery problem is indicated with the yellow LED (replace battery pattern) and the relay contact "Replace Battery". Please note that it can take up to 50 hours until a battery problem is reported. This should avoid nuisance error messages as any urgent battery problems will be reported by the "Check Wiring" test and create a warning signal. The battery tests require up to 50h uninterrupted operation. Any interruptions in the normal operation of the DC-UPS may result in the "Replace Battery" test cycle to start over.

When "Replace battery" is indicated, it is recommended to replace battery as soon as possible.

13. RELAY CONTACTS AND INHIBIT INPUT

The DC-UPS is equipped with relay contacts and signal inputs for remote monitoring and controlling of the unit.

Relay contacts:

- Ready:** Contact is closed when battery is charged more than 85%, no wiring failure are recognized, input voltage is sufficient and inhibit signal is not active.
- Buffering:** Contact is closed when unit is buffering.
- Replace Battery:** Contact is closed when the unit is powered from the input and the battery quality test (SOH test) reports a negative result.

Relay contact ratings	max	60Vdc 0.3A, 30Vdc 1A, 30Vac 0.5A resistive load
	min	1mA at 5Vdc min.
Isolation voltage	max	500Vac, signal port to power port

Signal input:

- Inhibit:** The inhibit input disables buffering. In normal mode, a static signal is required. In buffer mode, a pulse with a minimum length of 250ms is required to stop buffering. The inhibit is stored and can be reset by cycling the input voltage. See also section 28.1 for application notes.

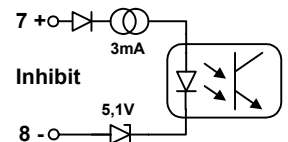

Signal voltage	max.	35Vdc
Signal current	max.	6mA, current limited
Inhibit threshold	min.	6Vdc, buffering is disabled above this threshold level
	max.	10Vdc
Isolation	nom.	500Vac, signal port to power port

Restriction apply when using the signal and relay contacts in a Haz-Loc environment:

The Buffering, Ready and Replace Battery contact is intended to be used for a separately investigated nonincendive field wiring and/or field wiring apparatus. The DC-UPS may be located in a Class I, Division 2 (Group A, B, C or D) hazardous (classified) location. Associated apparatus must be installed in accordance with its manufacturer's control drawing and Article 504 of the National Electrical Code (ANSI/NFPA 70) for installation in the United States, or Section 18 of the Canadian Electrical Code for Installations in Canada.

Selected associated apparatus must be third part listed as providing nonincendive field circuits for the application, and have Voc not exceeding Vmax, Isc not exceeding Imax.

Non associated nonincendive field wiring apparatuses shall not be connected in parallel unless this is permitted by the associated nonincendive field wiring apparatuses approval.

Fig. 13-1 **Contact control drawing for use in Haz-Loc environments**

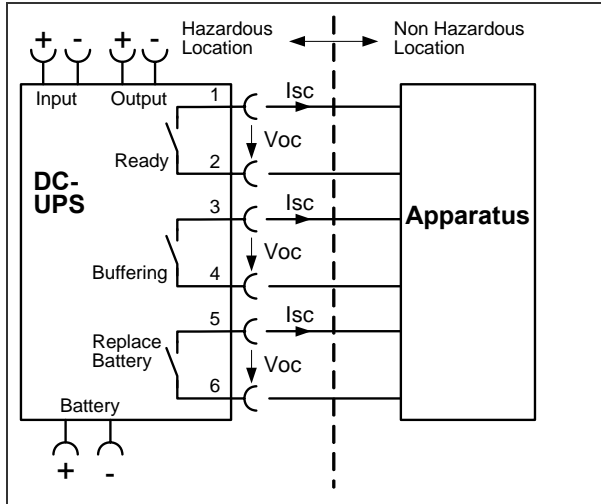

Selected barriers must have entity parameters such that
 $V_{oc} \leq V_{max}$, $I_{sc} \leq I_{max}$,
 $C_a \geq C_i + C_{cable}$, $L_a \geq L_i + L_{cable}$.
 For C_{cable} and L_{cable} , if the capacitance per foot
 or the inductance per foot is not known, then the
 following values shall be used: $C_{cable} = 60\text{pF/foot}$
 and $L_{cable} = 0.2\mu\text{H/foot}$.

Contact current: $I_{max} = 50\text{mA}$
 Contact voltage: $V_{max} = 35\text{V (DC or AC)}$
 Max. associated circuit capacitance $C_i = 0$
 Max. associated circuit inductance $L_i = 0$
 No polarity requirement

14. FRONT SIDE AND USER ELEMENTS

Main unit shown below without battery compartment.

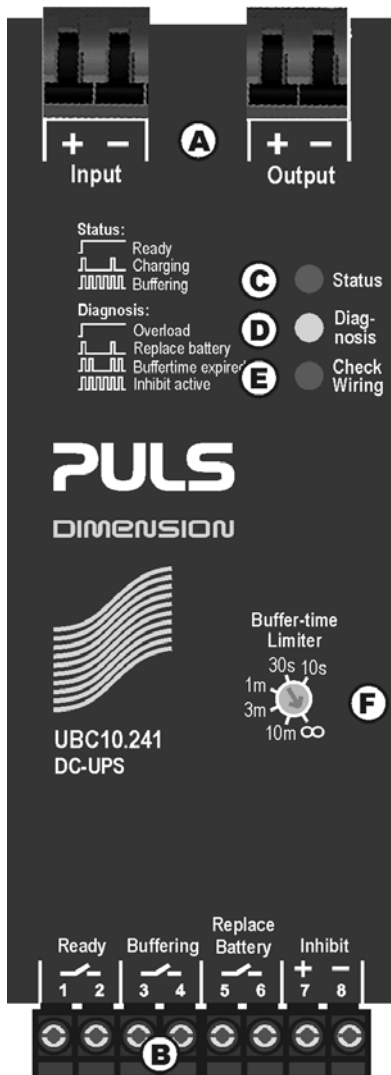

A Power Port

Quick-connect spring-clamp terminals, connection for input voltage and output voltage.

B Signal Port

Plug connector with screw terminals, inserted from the bottom. Connections for the Ready, Buffering, Replace Battery relay contacts and for the Inhibit input. See details in chapter 13.

C Green Status LED

Ready: Battery is charged > 85%, no wiring failures are recognized, input voltage is sufficient and inhibit signal is not active.

Charging: Battery is charging and the battery capacity is below 85%.

Buffering: Unit is in buffer mode.

Flashing pattern of the green status LED:

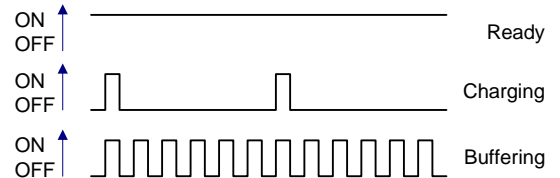

D Yellow Diagnosis LED

Overload: Output has switched off due to long overload in buffer mode or due to high temperatures.

Replace battery: Indicates a battery which failed the battery quality test (SoH test). Battery should be replaced as soon as possible.

Buffer-time expired: Output has switched off due to settings of Buffer-timer Limiter. This signal will be displayed for 15 minutes.

Inhibit active: Indicates that buffering is disabled due to an active inhibit signal.

Flashing pattern of the yellow diagnostic LED:

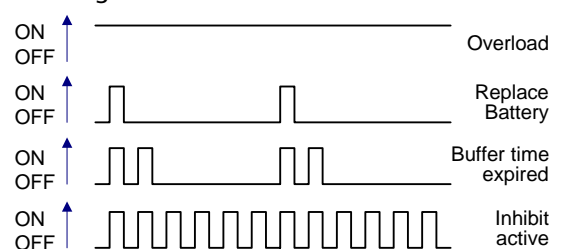

E Red Check Wiring LED

This LED indicates a failure in the installation (e.g. too low input voltage), wiring, battery or battery fuse.

F Buffer-time Limiter:

User accessible dial which limits the maximum buffer time in a buffer event to save battery energy. When the battery begins to recharge after a discharging event, the process is completed much faster since only the energy which was taken out of the battery needs to be "refilled". The following times can be selected: 10 seconds, 30 seconds, 1 minute, 3 minutes, 10 minutes or infinity (until battery is discharged) which allows buffering until the deep discharge protection stops buffering.

15. TERMINALS AND WIRING

	Power terminals	Signal terminals
Type	Bi-stable, quick-connect spring-clamp terminals. IP20 Finger-touch-proof. Suitable for field- and factory installation. Shipped in open position.	Plug connector with screw terminal. Finger-touch-proof construction with captive screws for 3.5mm slotted screwdriver. Suitable for field- and factory installation. Shipped in open position. To meet GL requirements, unused terminal compartments should be closed.
Solid wire	0.5-6mm ²	0.2-1.5mm ²
Stranded wire	0.5-4mm ²	0.2-1.5mm ²
AWG	20-10AWG	22-14AWG
Ferrules	Allowed, but not required	Allowed, but not required
Pull-out force	10AWG:80N, 12AWG:60N, 14AWG:50N, 16AWG:40N according to UL486E	Not applicable
Tightening torque	Not applicable	0.4Nm, 3.5lb.in
Wire stripping length	10mm / 0.4inch	6mm / 0.24inch

Fig. 15-1 Spring-clamp terminals, connecting a wire

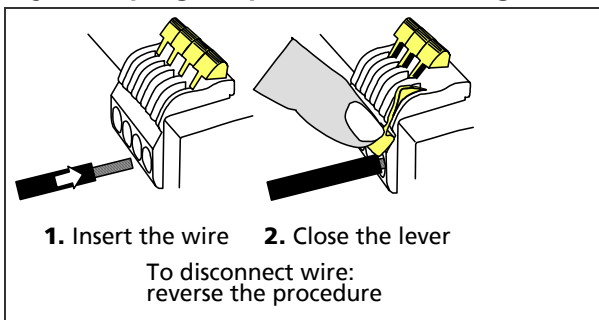

Instructions:

- a) Use appropriate copper cables, that are designed for an operating temperature of 60°C
- b) Follow national installation codes and regulations!
- c) Ensure that all strands of a stranded wire enter the terminal connection!
- d) Up to two stranded wires with the same cross section are permitted in one connection point

16. RELIABILITY

Lifetime expectancy	min.	137 400h	At 10A output current, 40°C
	min.	> 15 years	At 5A output current, 40°C
	min.	> 15 years	At 10A output current, 25°C
MTBF SN 29500, IEC 61709		886 000h	At 10A output current, 40°C
		1 482 000h	At 10A output current, 25°C
MTBF MIL HDBK 217F		397 900	At 10A output current , 40°C, ground benign GB40
		545 000	At 10A output current , 25°C, ground benign GB25

The **Lifetime expectancy** shown in the table indicates the operating hours (service life) and is determined by the lifetime expectancy of the built-in electrolytic capacitors. Lifetime expectancy is specified in operational hours. Lifetime expectancy is calculated according to the capacitor’s manufacturer specification. The prediction model allows a calculation of up to 15 years from date of shipment.

MTBF stands for **Mean Time Between Failure**, which is calculated according to statistical device failures and indicates reliability of a device. It is the statistical representation of the likelihood of a unit to fail and does not necessarily represent the life of a product.

All values except battery.

17. EMC

The unit is suitable for applications in industrial environment as well as in residential, commercial and light industry environment without any restrictions. CE mark is in conformance with EMC guideline 89/336/EC and 93/68/EC and the low-voltage directive (LVD) 73/23/EC, 93/68/EC.

A detailed EMC Report is available on request.

EMC Immunity	EN 61000-6-1, EN 61000-6-2	Generic standards		
Electrostatic discharge	EN 61000-4-2	Contact discharge	8kV	Criterion A*)
		Air discharge	15kV	Criterion A *)
Electromagnetic RF field	EN 61000-4-3	80MHz-1GHz	10V/m	Criterion A
Fast transients (Burst)	EN 61000-4-4	Out- and input lines	2kV	Criterion A
		Signal lines **)	2kV	Criterion A
Surge voltage	EN 61000-4-5	Output + → -	500V	Criterion A
		Input + → -	500V	Criterion A
		+ / - → housing	500V	Criterion A
Conducted disturbance	EN 61000-4-6	0,15-80MHz	10V	Criterion A

*) DIN-Rail earthed

***) Tested with coupling clamp

EMC Emission	EN 61000-6-3, EN 61000-6-4	Generic standards		
Conducted emission	EN 55022	Input lines	Class B *)	
		Output lines	Class B *)	
Radiated emission	EN 55011, EN 55022		Class B	

This device complies with FCC Part 15 rules.

Operation is subjected to the following two conditions: (1) this device may not cause harmful interference, and (2) this device must accept any interference received, including interference that may cause undesired operation.

*) Informative measurement with voltage probe

Switching frequencies	The DC-UPS has three converters with three different switching frequencies included.		
Switching frequency of boost converter	100kHz	Constant frequency	
Switching frequency of electronic output current limitation	78kHz	Constant frequency	
Switching frequency of battery charger	19.5kHz	Constant frequency	

18. ENVIRONMENT

Operational temperature	0°C to +40°C (32°F to 104°F)	Full output power
Storage temperature	-20°C to +50°C (-4°F to 122°F)	Storage and transportation
Humidity	5 to 95% r.H.	IEC 60068-2-30 Do not energize while condensation is present
Vibration sinusoidal	2-17.8Hz: ±1.6mm; 17.8-500Hz: 1g *)	IEC 60068-2-6
Shock	15g 6ms, 10g 11ms *)	IEC 60068-2-27
Altitude	0 to 6000m	Approvals apply only up to 2000m
Over-voltage category	III	EN 50178
	II	EN 50178 above 2000m altitude
Degree of pollution	2	EN 50178, not conductive

*) Use wall mounting accessory for higher values.

Fig. 18-1 **Normal Mode: Output current vs. ambient temperature**

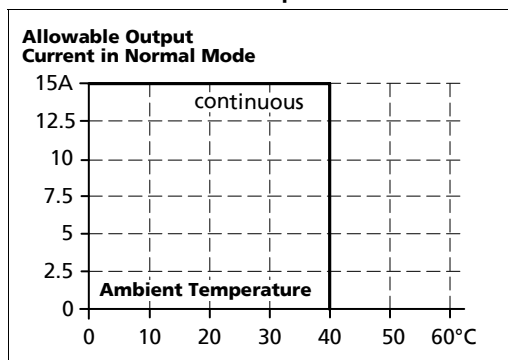
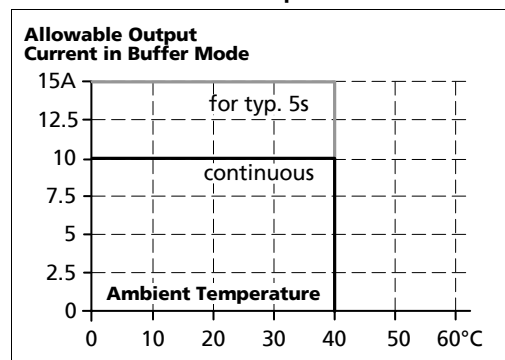

Fig. 18-2 **Buffer Mode: Output current vs. ambient temperature**



The ambient temperature is defined 2cm below the unit.

19. PROTECTION FEATURES

Output protection	Electronically protected against overload, no-load and short-circuits	
Output over-voltage protection in buffer mode	typ. 32Vdc max. 35Vdc	In case of an internal defect, a redundant circuitry limits the maximum output voltage. The output automatically shuts-down and makes restart attempts.
Degree of protection	IP20	EN/IEC 60529
Penetration protection	> 3.5mm	E.g. screws, small parts
Reverse battery polarity protection	yes	Max. -35Vdc;
Wrong battery voltage protection	yes	Max. +35Vdc (e.g. 24V battery instead of 12V battery)
Battery deep discharge protection	yes	The limit is battery current dependent
Over temperature protection	yes	Output shut-down with automatic restart
Input over-voltage protection	yes	Max. 35Vdc, no harm or defect of the unit
Internal input fuse	25A, blade type	No user accessible part, no service part



Jul. 2014 / Rev. 1.2 DS-UBC10.241-EN

All parameters are specified at an input voltage of 24V, 10A output load, 25°C ambient and after a 5 minutes run-in time unless otherwise noted. It is assumed that the input power source can deliver a sufficient output current.

20. SAFETY

Output voltage	SELV PELV Max. allowed voltage between any input, output or signal pin and ground: 60Vdc or 42.4Vac	IEC/EN 60950-1 EN 60204-1, EN 50178, IEC 60364-4-41
Class of protection	III	PE (Protective Earth) connection is not required
Isolation resistance	> 5MΩ	Power port to housing, 500Vdc
Dielectric strength	500Vac	Power port to signal port
	500Vac	Power port / signal port to housing
Touch current (leakage current)	The leakage current which is produced by the DC-UPS itself depends on the input voltage ripple and need to be investigated in the final application. For a smooth DC input voltage, the produced leakage current is less than 100µA.	

21. APPROVALS

UL 508		LISTED E198865 listed for use in U.S.A. (UL 508) and Canada (C22.2 No. 14-95) Industrial Control Equipment
UL 60950-1		RECOGNIZED E137006 recognized for the use in U.S.A. (UL 60950-1) and Canada (C22.2 No. 60950) Information Technology Equipment, Level 5
UL 1604		RECOGNIZED E246877 recognized for use in U.S.A. (UL 1604) and Canada (C22.2 No. 213-M1987) Hazardous Location Class I Div 2 T4 Groups A,B,C,D and Class I Zone 2 Groups IIA, IIB and IIC
The unit is suitable for use in Class I Division 2 Groups A, B, C, D locations as well as for Class I Zone 2 Groups IIA, IIB and IIC locations. Substitution of components may impair suitability for Class I Division 2 environment. Do not disconnect equipment unless power has been switched off. Wiring must be in accordance with Class I, Division 2 wiring methods of the National Electrical Code, NFPA 70, and in accordance with other local or national codes.		
CSA		CSA approval for Canada CAN/CSA C22.2 No 107-1; CAN/ CSA 60950-1-03; UL60950-1
IEC 60950-1		CB Scheme, Information Technology Equipment
Marine		GL (Germanischer Lloyd) classified and ABS (American Bureau for Shipping) PDA for marine and offshore applications. Environmental category: A, EMC2

22. FULFILLED STANDARDS

EN/IEC 60204-1	Safety of Electrical Equipment of Machines
EN/IEC 61131	Programmable Controllers
EN 50178, IEC 62103	Electronic Equipment in Power Installations

Jul. 2014 / Rev. 1.2 DS-UBC10.241-EN

All parameters are specified at an input voltage of 24V, 10A output load, 25°C ambient and after a 5 minutes run-in time unless otherwise noted. It is assumed that the input power source can deliver a sufficient output current.

23. USED SUBSTANCES

The unit does not release any silicone and is suitable for the use in paint shops.

The unit conforms to the RoHS directive 2002/96/EC.

Electrolytic capacitors included in this unit do not use electrolytes such as Quaternary Ammonium Salt Systems.

Plastic housings and other molded plastic materials are free of halogens.

The materials used in our production process do not include the following toxic chemicals:

Polychlorinated Biphenyl (PCB), Pentachlorophenol (PCP), Polychlorinated naphthalene (PCN), Polybrominated Biphenyl (PBB), Polybrominated Biphenyl Oxide (PBO), Polybrominated Diphenyl Ether (PBDE), Polychlorinated Diphenyl Ether (PCDE), Polybrominated Diphenyl Oxide (PBDO), Cadmium, Asbestos, Mercury, Silica

24. PHYSICAL DIMENSIONS AND WEIGHT

Width	123mm / 4.84"	
Height	124mm / 4.88"	Plus height of signal connector plug and Spare fuse
Depth	119mm / 4.69"	Plus depth of DIN-rail
Weight	2850g / 6.28lb	
DIN-Rail	Use 35mm heavy duty DIN-rails according to EN 60715 or EN 50022. The DIN-rail height must be added to the depth (119mm) to calculate the total required installation depth.	

Electronic files with mechanical data can be downloaded at www.pulspower.com

Fig. 24-1 Side view

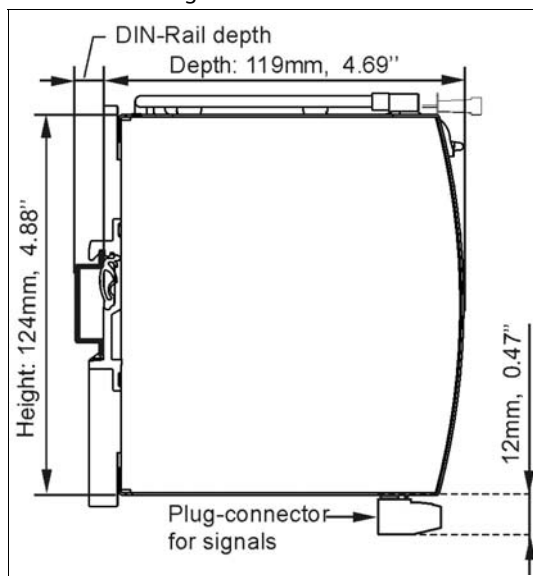
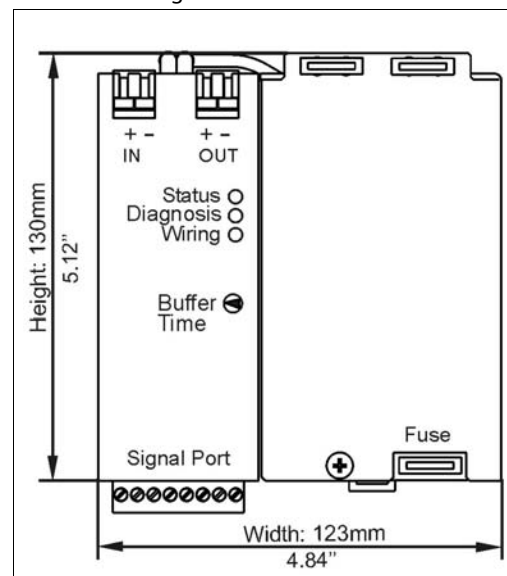

Fig. 24-2 Front view



25. INSTALLATION NOTES

Mounting:

The power terminals shall be located on top of the unit. An appropriate electrical and fire end-product enclosure should be considered in the end use application.

Do not install unit in airtight housings or cabinets. The site in which the unit is located must have sufficient ventilation acc. to EN50272-2.

Cooling: Convection cooled, no forced air cooling required. Do not obstruct air flow!

Installation clearances: 40mm on top, 20mm on the bottom, 5mm on the left and right side are recommended when loaded permanently with full power. In case the adjacent device is a heat source, 15mm clearance are recommended.

Risk of electrical shock, fire, personal injury or death!

Turn power off and disconnect battery fuse before working on the DC-UPS. Protect against inadvertent re-powering. Make sure the wiring is correct by following all local and national codes. Do not open, modify or repair the unit, except replacement of the battery. Use caution to prevent any foreign objects from entering into the housing. Do not use in wet locations or in areas where moisture or condensation can be expected.

Service parts:

The DC-UPS contains an integrated battery which must be changed on a periodic basis, see chapter 26 and. 28.1.

The tripping of an internal fuse is caused by an internal fault. If damage or malfunctioning should occur during operation, immediately turn power off and send unit to the factory for inspection! For Troubleshooting see 28.4.

Wiring and installation instructions:

- (1) It is recommended to install the DC-UPS in a place where the integrated battery will not be heated up by adjacent equipment. The unit is equipped with a fuseholder and a 30A battery fuse type ATO[®] 257 030 (Littelfuse). The battery fuse protects the wires between the battery and the DC-UPS. It also allows the disconnection of the battery from the DC-UPS which is recommended when working on the battery or DC-UPS. Disconnect battery fuse before connecting the battery.
- (2) Connect the power supply to the input terminals of the DC-UPS.
- (3) Connect the buffered load to the output terminals of the DC-UPS. The output is decoupled from the input allowing load circuits to be easily split into buffered and non buffered sections. Noncritical loads can be connected directly to the power supply and will not be buffered. The energy of the battery can then be used in the circuits which require buffering.
- (4) Plug-in the fuse when the wiring is finished.

Fig. 25-1 Typical wiring diagram

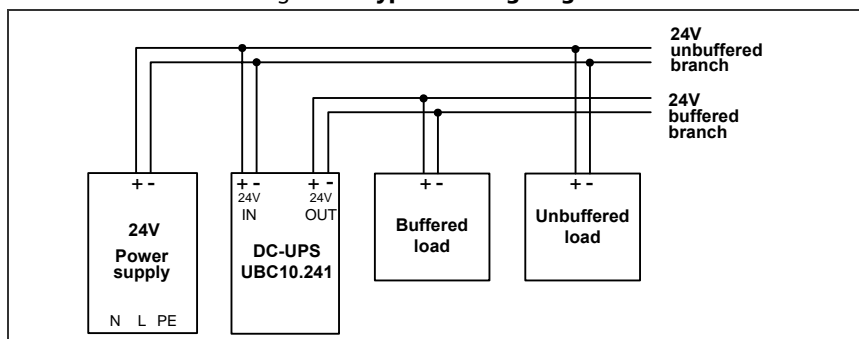

26. REPLACEMENT OF THE BATTERY

The integrated battery should be replaced on a periodic basis, see chapter 28.1 for additional information.

The replacement should be done by qualified personnel trained on battery handling.

Caution! The terminals on the battery are always alive, therefore do not place items or tools on the battery!

How to replace the battery:

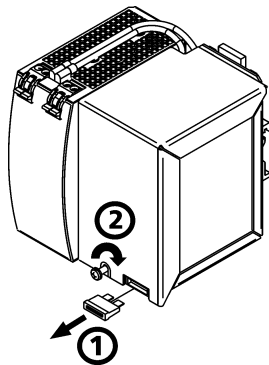

Step 1:
Remove the fuse before working on the unit.

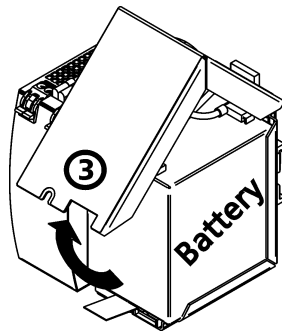

Step 2:
Loosen the captive cover screw.

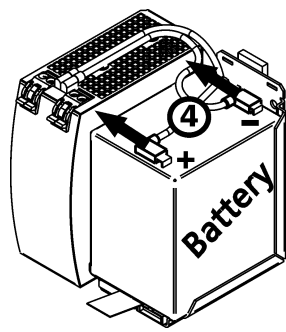

Step 3:
Remove the battery-cover.

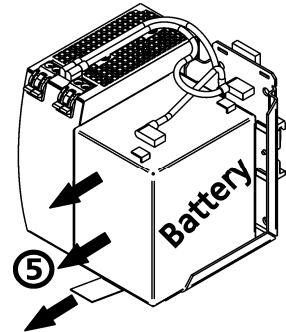

Step 4:
Disconnect the cables from the battery terminals.

Step 5:
Remove the battery by pulling on the strap.

Step 6: Install the new battery.

Step 7: Connect the red cable (+) to the red positive (+) terminal of the battery.

Step 8: Connect the black cable (-) to the black negative (-) terminal of the battery.

Step 9: Close the cover.

Step 10: Tighten the screw.

Step 11: Plug-in the fuse.

Disposal of batteries

Batteries marked with the recycling symbol should be recycled through a competent agency.



Replacement battery

See chapter 27 for information on the UZB12.051 or you can use a battery which meets the following requirements:

Battery type	nom.	12V, 4 to 6Ah	VRLA lead-acid maintenance free battery
Design life	min.	3 to 5 years	According to EUROBAT guideline
Dimensions	nom.	70x106x90mm	WxHxD *)
Pole connection		6.35mm/ 0.25Inch	Blade type; Fast-on
Approvals		UL, VdS	For applications which require UL or VdS
Allowed discharge current	min.	29A	Continuous

*) Max. case height of 102mm

27. ACCESSORIES

Battery

The integrated battery should be replaced on a periodic basis, see chapter 28.1.

As replacement the UZB12.051 can be used.

UZB12.051

Battery type	Highcurrent version 12V, 5Ah	VRLA lead-acid maintenance free battery
Design life	3 to 5 years	According to EUROBAT guideline
Dimensions	70x106x90mm	Width x total height x depth
Pole connection	6.35mm/ 0.25Inch	Blade type; Fast-on
Weight	2kg/ 4.41lb	
Order number	UZB12.051	Battery for UBC10.241

Fig. 27-1 UZB12.051



Wall mounting bracket

Type ZM1.UBC10 is under preparation, please consult PULS.

28. APPLICATION NOTES

28.1. BATTERY REPLACEMENT INTERVALS

Batteries have a limited life time. They degrade slowly beginning from the production and need to be replaced periodically. The design life figures can be found in the individual datasheets of the batteries and usually is specified according to the Eurobat guideline or according to the manufacturer's specifications.

The design life is the estimated life based on laboratory condition, and is quoted at 20°C using the manufacturer's recommended float voltage condition. According to the Eurobat guideline, design lives have been structured into the following different groups:

- 3 - 5 years: This group of batteries is very popular in standby applications and in small emergency equipment. This represents a 4 years design life with a production tolerance of ± 1 year.
- 6 - 9 years: This group of batteries is usually used when an improved life is required. This represents a 7.5 years design life with a production tolerance of ± 1.5 years.
- 10 - 12 years: This group of batteries is used when in applications where longest life and highest safety level are required. This represents a 11 years design life with a production tolerance of ± 1 year.

A battery failure within the specified design life of the battery usually results in a complete loss of the battery function (broken cell, defect connection, ...) and will be detected and reported by the periodical battery tests which are included in the UBC10.241 DC-UPS control unit.

If the operational parameters differ from those which are specified for the design life, an earlier change of the battery might be necessary. The "real life" is called service life and is defined as the point at which the cell's actual capacity has reached 80% of its nominal capacity. At the end of the service life the capacity degrades much faster, so that a further use of the battery is not recommended.

Temperature effect:

The temperature has the most impact in the service life. The hotter the temperature, the earlier the wear-out phase of the battery begins. The wear-out results in a degradation of battery capacity. See Fig. 28-1 for details.

Effect of discharging cycles

The number as well as the depth of discharging cycles is limited. A replacement of the battery might be necessary earlier than the calculated service life if the battery exceeds the numbers and values of Fig. 28-2.

Other effects which shorten the service life

- Overcharging and deep discharging shortens the service life and should be avoided. Thanks to the single battery concept of the UBC10.241, the end-of-charge voltage is precisely set automatically avoiding unnecessary aging effects.
- Charge retention is important to get the longest battery life. Stored batteries which are not fully charged age faster than charged batteries. Batteries which are not in use should be recharged at least once a year.
- Excessive float charge ripple across the battery has an effect of reducing life and performance. The UBC10.241 does not produce such a ripple voltage. This effect can be ignored when the battery is charged with the UBC10.241.

Guidelines for a long battery service life:

- Place the DC-UPS in a cool location: E.g. near the bottom of the control cabinet.
- Do not place the DC-UPS near heat generating devices.
- Do not store discharged batteries.
- Do not discharge the battery more than necessary. Set buffer time limiter to the required buffer time.
The depth of discharge reduces the service life of the battery and limits the number of cycles. See Fig. 28-2.

Example for calculating the service life and the required replacement cycle:

Parameters for the example:

- A 5Ah battery with a design life of 3-5 years is used (e.g. Yuasa battery which is used for type UZB12.051)
- The average ambient temperature is 30°C
- One buffer event consumes approx. 25% of the achievable buffer time.
- One buffer event per day

Calculation:

Ambient temperature influence:

According to Fig. 28-1 curve A, a 2 years service life can be expected for an ambient temperature of 30°C.

Number of discharging cycles: 2 years * 365 cycles = 730cycles in 2 years.

According to Fig. 28-2, curve C has to be used (only 25% of battery capacity is required). 730 cycles have only a negligible influence in a battery degradation and can be ignored.

Result:

The battery shall be replaced after 2 years.

Please note that the battery degrading begins from the production date (check date code on the battery) which may shorten the replacement intervals.

Fig. 28-1 **Service life versus ambient temperatures, typ *)**

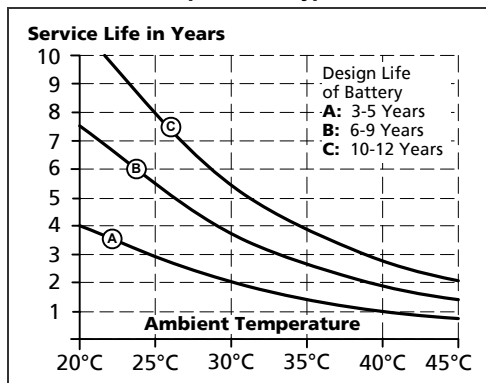
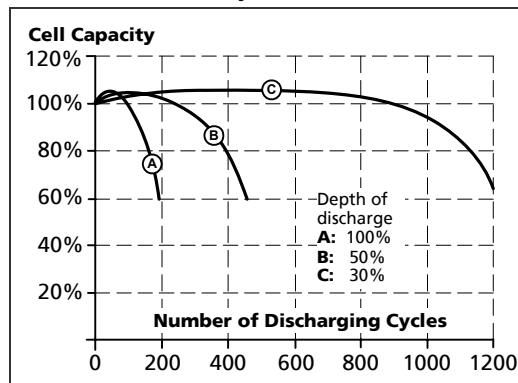

Fig. 28-2 **Cell capacity degradation vs. discharging cycles *)**



*) datasheet figures from battery manufacturer

28.2. PARALLEL AND SERIAL USE

Do not use the DC-UPS in parallel to increase the output power. However, two units of the DC-UPS can be paralleled for 1+1 redundancy to gain a higher system reliability.

Do not use batteries in parallel, since the battery quality test might create an error message.

Do not connect two or more units in series for higher output voltages.

Do not connect two or more units in a row to get longer hold-up times.

28.3. USING THE INHIBIT INPUT

The inhibit input disables buffering. In normal mode, a static signal is required. In buffer mode, a pulse with a minimum length of 250ms is required to stop buffering. The inhibit is stored and can be reset by cycling the input voltage.

For service purposes, the inhibit input can also be used to connect a service switch. Therefore, the inhibit signal can be supplied from the output of the DC-UPS.

Fig. 28-3 Wiring example for inhibit input

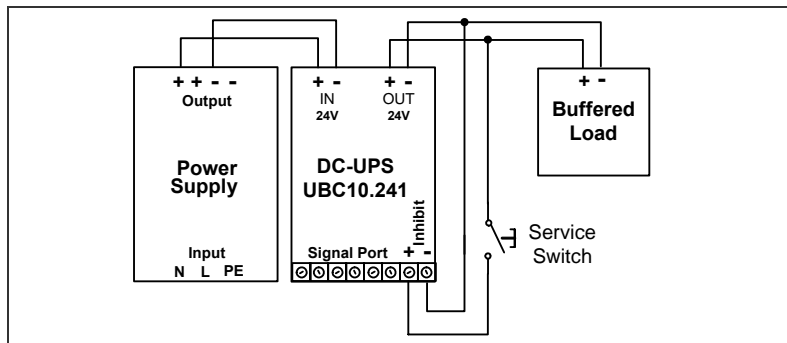

28.4. TROUBLESHOOTING

The LEDs on the front of the unit and relay contacts indicate the status of the DC-UPS. Please see also chapter 14. The following guidelines provide instructions for fixing the most common failures and problems. Always start with the most likely and easiest-to-check condition. Some of the suggestions may require special safety precautions. See notes in section 25 first.

- “Check wiring” LED is on**
 - Check correct wiring between the battery and the DC-UPS
 - Check battery fuse. Is the battery fuse inserted or blown?
 - Check battery voltage (must be typically between 7.4V and 15.1V)
 - Check input voltage (must be typically between 22.8V and 30V)
 - Check battery polarity
- DC-UPS did not buffer**
 - Inhibit input was set
 - Battery did not have enough time to be charged and is still below the deep discharge protection limit.
- DC-UPS stopped buffering**
 - Buffer time limiter stopped buffering → set buffer time limiter to a higher value
 - Deep discharge protection stopped buffering → allow sufficient time for charging the battery
 - Output was overloaded or short circuit → reduce load
- Output has shut down**
 - Cycle the input power to reset the DC-UPS
 - Let DC-UPS cool down, over temperature protection might have triggered.
- DC-UPS constantly switches between normal mode and buffer mode**
 - The supplying source on the input is too small and can not deliver sufficient current → Use a larger power supply or reduce the output load
 - The input voltage is same as transfer threshold. → Increase input voltage