

ITEM NO.	PART NUMBER	DESCRIPTION	QTY.	NOTES
1	TLY-1P	NEMA 1-15P, polarized	1	white overmold
2	30-00243	2C, 18 AWG, UL SPT-1, 300V, 105°C, 5.55 mm, VW-1, PVC, white	1	terminates to stripped and tinned

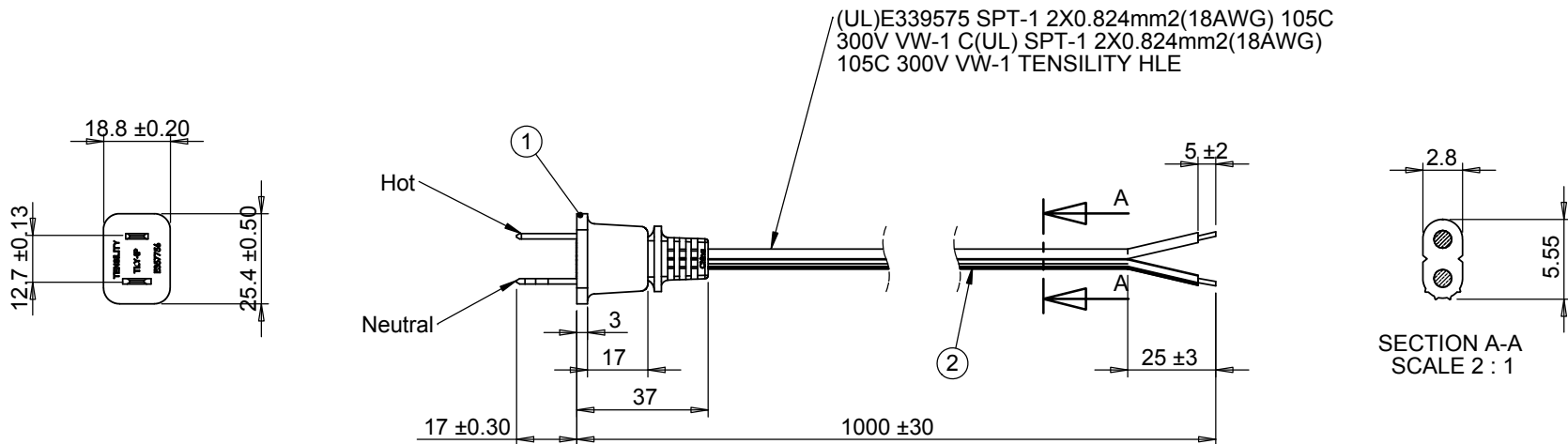

Wiring diagram	
Contact	Wire
Neutral	Grooved
Hot	Smooth

Revision	Date	Description	Notes		<h1>TENSILITY</h1> <p>20802 Sockeye Place #130 Bend, OR 97701 USA tel 541.323.3228 fax 541.323.4202 800 877.670.7118 www.tensility.com</p>		
A	12/17/2012	Initial release	Cable rated for 10 A at 125 Vac as is. RoHS, REACH and Dodd-Frank conflict materials compliant Function test: no open, no reversed polarity, no short circuit, no INT				
			DIMENSIONS ARE IN MILLIMETERS TOLERANCES: X: ± 0.5 mm X.X: ± 0.3 mm X.XX: ± 0.05 mm	DESCRIPTION: Ac cord, 1000 mm, U.S, NEMA 1-15P plug, TLY-1P to tinned, 18 AWG, SPT-1 wire, 30-00243, white	SIZE A	Part number <b>11-00032</b>	
					SCALE:1:2	WEIGHT:	SHEET 1 OF 1