

MMFT960T1

Preferred Device

Power MOSFET 300 mA, 60 Volts

N-Channel SOT-223

This Power MOSFET is designed for high speed, low loss power switching applications such as switching regulators, dc-dc converters, solenoid and relay drivers. The device is housed in the SOT-223 package which is designed for medium power surface mount applications.

Features

- Silicon Gate for Fast Switching Speeds
- Low Drive Requirement
- The SOT-223 Package can be Soldered Using Wave or Reflow
- The Formed Leads Absorb Thermal Stress During Soldering Eliminating the Possibility of Damage to the Die
- Pb-Free Package is Available

MAXIMUM RATINGS ($T_C = 25^\circ\text{C}$ unless otherwise noted)

Rating	Symbol	Value	Unit
Drain-to-Source Voltage	V_{DS}	60	V
Gate-to-Source Voltage – Non-Repetitive	V_{GS}	± 30	V
Drain Current	I_D	300	mA _{dc}
Total Power Dissipation @ $T_A = 25^\circ\text{C}$ (Note 1) Derate above 25°C	P_D	0.8 6.4	W mW/ $^\circ\text{C}$
Operating and Storage Temperature Range	T_J, T_{stg}	-65 to 150	$^\circ\text{C}$

THERMAL CHARACTERISTICS

Thermal Resistance, Junction-to-Ambient	$R_{\theta JA}$	156	$^\circ\text{C}/\text{W}$
Maximum Temperature for Soldering Purposes Time in Solder Bath	T_L	260 10	$^\circ\text{C}$ S

Maximum ratings are those values beyond which device damage can occur. Maximum ratings applied to the device are individual stress limit values (not normal operating conditions) and are not valid simultaneously. If these limits are exceeded, device functional operation is not implied, damage may occur and reliability may be affected.

1. Device mounted on a FR-4 glass epoxy printed circuit board using minimum recommended footprint.



ON Semiconductor®

<http://onsemi.com>

300 mA, 60 VOLTS
 $R_{DS(on)} = 1.7 \Omega$

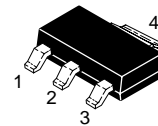
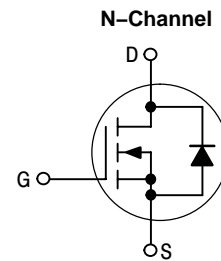

TO-261AA
CASE 318E
STYLE 3

MARKING DIAGRAM AND PIN ASSIGNMENT

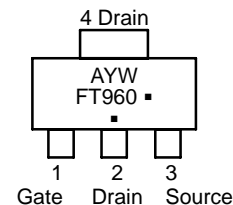

A = Assembly Location
Y = Year
W = Work Week
▪ = Pb-Free Package
FT960 = Device Code
(Note: Microdot may be in either location)

ORDERING INFORMATION

Device	Package	Shipping†
MMFT960T1	SOT-223	1000 Tape & Reel
MMFT960T1G	SOT-223 (Pb-Free)	1000 Tape & Reel

†For information on tape and reel specifications, including part orientation and tape sizes, please refer to our Tape and Reel Packaging Specifications Brochure, BRD8011/D.

Preferred devices are recommended choices for future use and best overall value.

MMFT960T1

ELECTRICAL CHARACTERISTICS ($T_A = 25^\circ\text{C}$ unless otherwise noted)

Characteristic	Symbol	Min	Typ	Max	Unit
OFF CHARACTERISTICS					
Drain-to-Source Breakdown Voltage ($V_{GS} = 0, I_D = 10 \mu\text{A}$)	$V_{(BR)DSS}$	60	-	-	Vdc
Zero Gate Voltage Drain Current ($V_{DS} = 60 \text{ V}, V_{GS} = 0$)	I_{DSS}	-	-	10	μA_{dc}
Gate-Body Leakage Current ($V_{GS} = 15 \text{ Vdc}, V_{DS} = 0$)	I_{GSS}	-	-	50	nA_{dc}

ON CHARACTERISTICS (Note 2)

Gate Threshold Voltage ($V_{DS} = V_{GS}, I_D = 1.0 \text{ mA}_{dc}$)	$V_{GS(th)}$	1.0	-	3.5	Vdc
Static Drain-to-Source On-Resistance ($V_{GS} = 10 \text{ Vdc}, I_D = 1.0 \text{ A}$)	$R_{DS(on)}$	-	-	1.7	Ω
Drain-to-Source On-Voltage ($V_{GS} = 10 \text{ V}, I_D = 0.5 \text{ A}$) ($V_{GS} = 10 \text{ V}, I_D = 1.0 \text{ A}$)	$V_{DS(on)}$	-	-	0.8 1.7	Vdc
Forward Transconductance ($V_{DS} = 25 \text{ V}, I_D = 0.5 \text{ A}$)	g_{fs}	-	600	-	mmhos

DYNAMIC CHARACTERISTICS

Input Capacitance	$(V_{DS} = 25 \text{ V}, V_{GS} = 0, f = 1.0 \text{ MHz})$	C_{iss}	-	65	-	μF
Output Capacitance		C_{oss}	-	33	-	
Transfer Capacitance		C_{rss}	-	7.0	-	
Total Gate Charge	$(V_{GS} = 10 \text{ V}, I_D = 1.0 \text{ A}, V_{DS} = 48 \text{ V})$	Q_g	-	3.2	-	nC
Gate-Source Charge		Q_{gs}	-	1.2	-	
Gate-Drain Charge		Q_{gd}	-	2.0	-	

2. Pulse Test: Pulse Width $\leq 300 \mu\text{s}$, Duty Cycle $\leq 2.0\%$.

TYPICAL ELECTRICAL CHARACTERISTICS

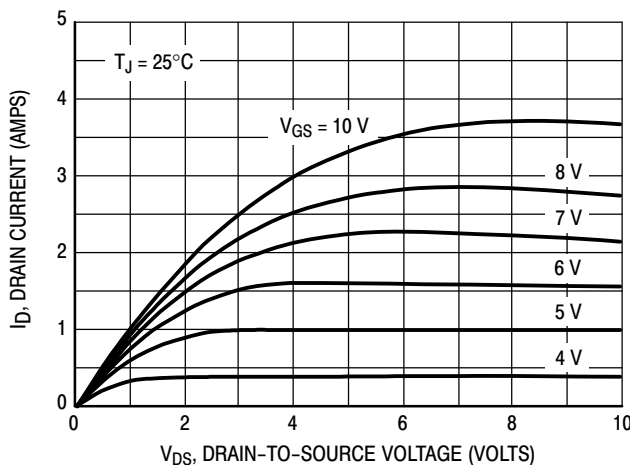

Figure 1. On-Region Characteristics

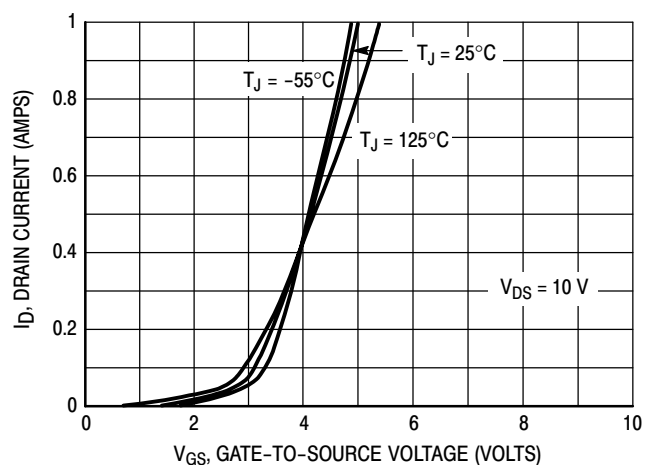

Figure 2. Transfer Characteristics

MMFT960T1

TYPICAL ELECTRICAL CHARACTERISTICS

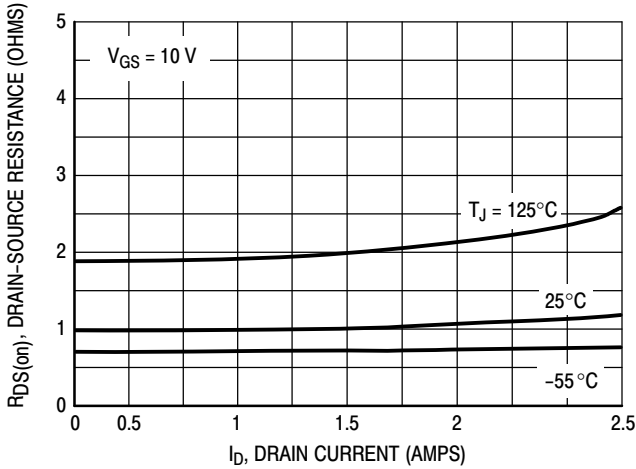

Figure 3. On-Resistance versus Drain Current

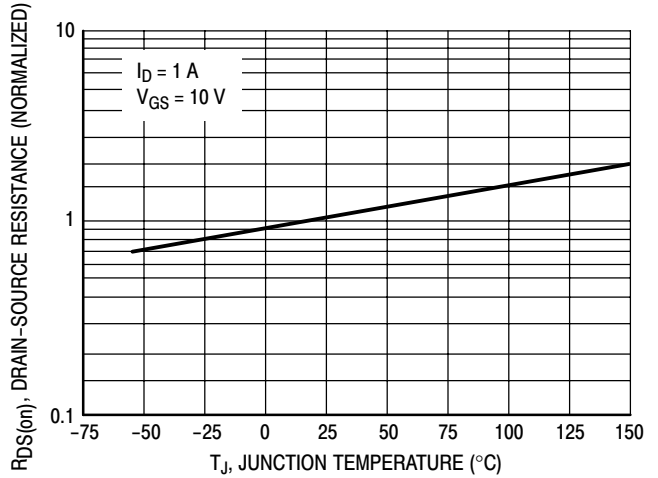

Figure 4. On-Resistance Variation with Temperature

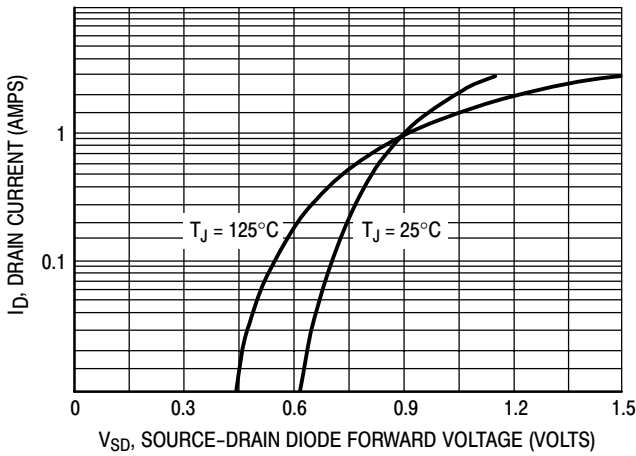

Figure 5. Source-Drain Diode Forward Voltage

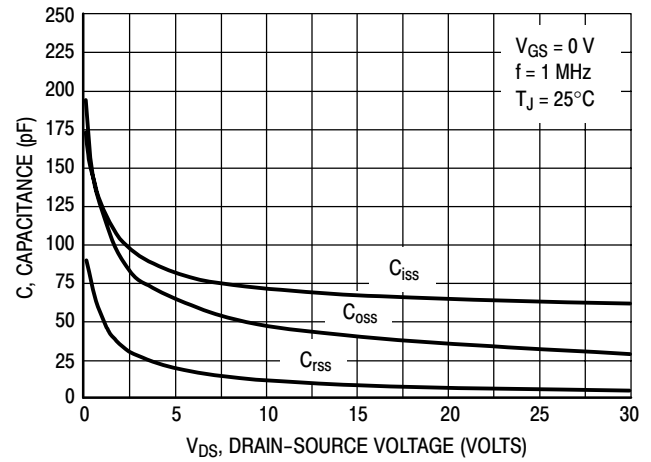

Figure 6. Capacitance Variation

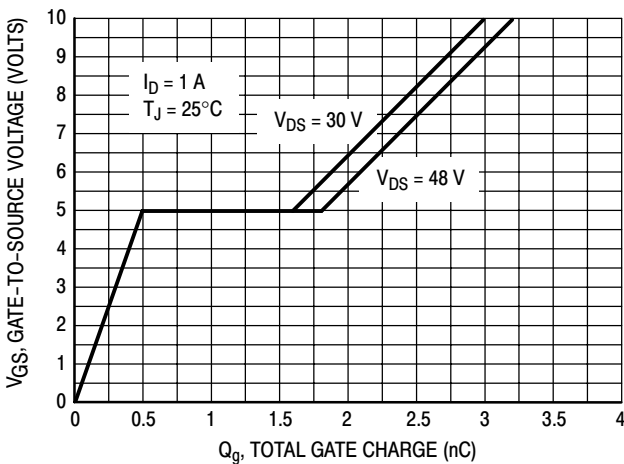

Figure 7. Gate Charge versus Gate-to-Source Voltage

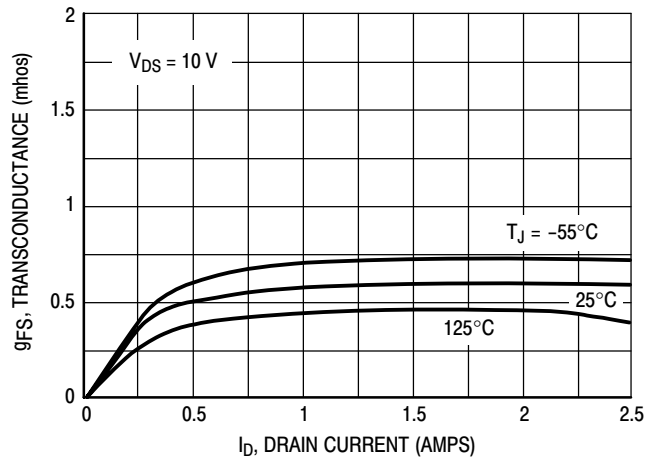
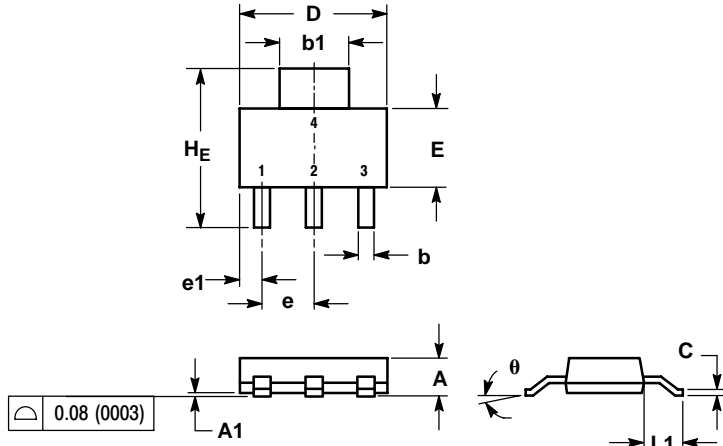

Figure 8. Transconductance

MMFT960T1

PACKAGE DIMENSIONS

SOT-223 (TO-261)
CASE 318E-04
ISSUE L



- NOTES:
1. DIMENSIONING AND TOLERANCING PER ANSI Y14.5M, 1982.
2. CONTROLLING DIMENSION: INCH.

DIM	MILLIMETERS			INCHES		
	MIN	NOM	MAX	MIN	NOM	MAX
A	1.50	1.63	1.75	0.060	0.064	0.068
A1	0.02	0.06	0.10	0.001	0.002	0.004
b	0.60	0.75	0.89	0.024	0.030	0.035
b1	2.90	3.06	3.20	0.115	0.121	0.126
c	0.24	0.29	0.35	0.009	0.012	0.014
D	6.30	6.50	6.70	0.249	0.256	0.263
E	3.30	3.50	3.70	0.130	0.138	0.145
e	2.20	2.30	2.40	0.087	0.091	0.094
e1	0.85	0.94	1.05	0.033	0.037	0.041
L1	1.50	1.75	2.00	0.060	0.069	0.078
HE	6.70	7.00	7.30	0.264	0.276	0.287
θ	0°	-	10°	0°	-	10°

- STYLE 3:
PIN 1. GATE
2. DRAIN
3. SOURCE
4. DRAIN

SOLDERING FOOTPRINT*

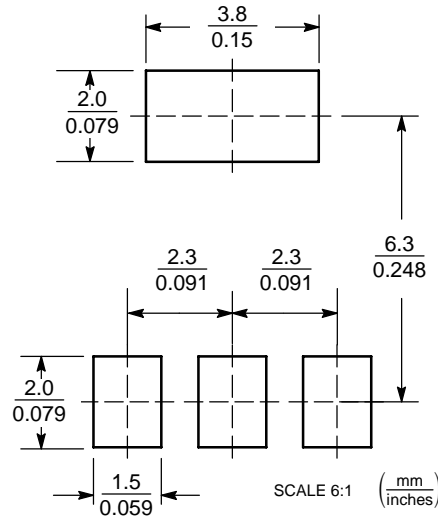

*For additional information on our Pb-Free strategy and soldering details, please download the ON Semiconductor Soldering and Mounting Techniques Reference Manual, SOLDERRM/D.

ON Semiconductor and are registered trademarks of Semiconductor Components Industries, LLC (SCILLC). SCILLC reserves the right to make changes without further notice to any products herein. SCILLC makes no warranty, representation or guarantee regarding the suitability of its products for any particular purpose, nor does SCILLC assume any liability arising out of the application or use of any product or circuit, and specifically disclaims any and all liability, including without limitation special, consequential or incidental damages. "Typical" parameters which may be provided in SCILLC data sheets and/or specifications can and do vary in different applications and actual performance may vary over time. All operating parameters, including "Typicals" must be validated for each customer application by customer's technical experts. SCILLC does not convey any license under its patent rights nor the rights of others. SCILLC products are not designed, intended, or authorized for use as components in systems intended for surgical implant into the body, or other applications intended to support or sustain life, or for any other application in which the failure of the SCILLC product could create a situation where personal injury or death may occur. Should Buyer purchase or use SCILLC products for any such unintended or unauthorized application, Buyer shall indemnify and hold SCILLC and its officers, employees, subsidiaries, affiliates, and distributors harmless against all claims, costs, damages, and expenses, and reasonable attorney fees arising out of, directly or indirectly, any claim of personal injury or death associated with such unintended or unauthorized use, even if such claim alleges that SCILLC was negligent regarding the design or manufacture of the part. SCILLC is an Equal Opportunity/Affirmative Action Employer. This literature is subject to all applicable copyright laws and is not for resale in any manner.

PUBLICATION ORDERING INFORMATION

LITERATURE FULFILLMENT:
Literature Distribution Center for ON Semiconductor
P.O. Box 61312, Phoenix, Arizona 85082-1312 USA
Phone: 480-829-7710 or 800-344-3860 Toll Free USA/Canada
Fax: 480-829-7709 or 800-344-3867 Toll Free USA/Canada
Email: orderlit@onsemi.com

N. American Technical Support: 800-282-9855 Toll Free
USA/Canada

Japan: ON Semiconductor, Japan Customer Focus Center
2-9-1 Kamimeguro, Meguro-ku, Tokyo, Japan 153-0051
Phone: 81-3-5773-3850

ON Semiconductor Website: <http://onsemi.com>

Order Literature: <http://www.onsemi.com/litorder>

For additional information, please contact your local Sales Representative.