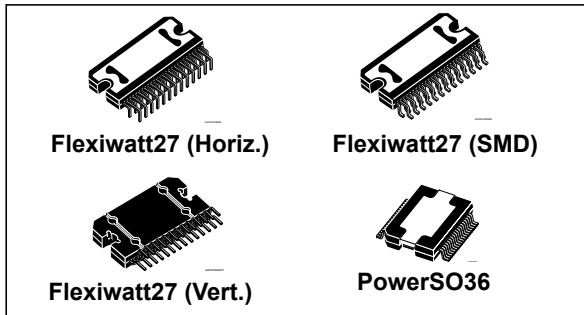


## 4 x 45 W power amplifier with full I<sup>2</sup>C diagnostics, high efficiency and low voltage operation

Datasheet - production data



- Improved SVR suppression during battery transients
- Capable to operate down to 6 V (e.g. "Start-stop")

### Description

The TDA75610LV is a new quad bridge car radio amplifier, designed in BCD technology, in order to include a wide range of innovative features in a very compact and flexible device.

The TDA75610LV is equipped with the most complete diagnostics array that communicates the status of each speaker through the I<sup>2</sup>C bus.

The dissipated output power under average listening condition is significantly reduced when compared to the conventional class AB solutions, thanks to the patented 'class SB' efficiency concept. TDA75610LV has been designed to be very robust against several kinds of misconnections. It is moreover compliant to the most recent OEM specifications for low voltage operation (so called 'start-stop' battery profile during engine stop), helping car manufacturers to reduce the overall emissions and thus contributing to environment protection. The ST BCD in combination with 'class SB' efficiency and 'intelligent power' has been sold in million of units to most known car manufacturers, the TDA75610LV is the last and most compact member of this power amplifiers family.

### Features

- Multipower BCD technology
- MOSFET output power stage
- DMOS power output
- High efficiency (class SB)
- High output power capability 4x25 W/4 Ω @ 14.4 V, 1 kHz, 10% THD, 4 x 45 W max power
- 2 Ω driving capability (64 W max power)
- Full I<sup>2</sup>C bus driving:
  - Standby
  - Independent front/rear soft play/mute
  - Selectable gain 26 dB /16 dB (for low noise line output function)
  - High efficiency enable/disable
  - I<sup>2</sup>C bus digital diagnostics (including DC and AC load detection)
- Flexible fault detection through integrated diagnostic
- DC offset detection
- Four independent short circuit protection
- Clipping detector pin with selectable threshold (2 %/10 %)
- Standby/mute pin
- Linear thermal shutdown with multiple thermal warning
- ESD protection
- Very robust against misconnections

**Table 1. Device summary**

Order code	Package	Packing
TDA75610LVSM	Flexiwatt27 (SMD)	Tube
TDA75610LVSMTR		Tape and reel
TDA75610LV	Flexiwatt27 (vert.)	Tube
TDA75610LVH	Flexiwatt27 (horiz.)	Tube
TDA75610LVPD	PowerSO36	Tube
TDA75610LVPDTR		Tape and reel

# Contents

<b>1</b>	<b>Block diagram and application circuits</b>	<b>6</b>
<b>2</b>	<b>Pin description</b>	<b>8</b>
<b>3</b>	<b>Electrical specifications</b>	<b>10</b>
3.1	Absolute maximum ratings	10
3.2	Thermal data	10
3.3	Electrical characteristics	11
3.4	Typical electrical characteristics curves	15
<b>4</b>	<b>Diagnostics functional description</b>	<b>18</b>
4.1	Turn-on diagnostic	18
4.2	Permanent diagnostics	20
4.3	Output DC offset detection	21
4.4	AC diagnostic	21
<b>5</b>	<b>Multiple faults</b>	<b>23</b>
5.1	Faults availability	23
<b>6</b>	<b>Thermal protection</b>	<b>24</b>
6.1	Fast muting	24
<b>7</b>	<b>Battery transitions management</b>	<b>25</b>
7.1	Low voltage operation (“start stop”)	25
7.2	Advanced battery management	26
<b>8</b>	<b>Application suggestion</b>	<b>27</b>
8.1	Inputs impedance matching	27
8.2	High efficiency introduction	28
<b>9</b>	<b>I<sup>2</sup>C bus</b>	<b>29</b>
9.1	I <sup>2</sup> C programming/reading sequences	29
9.2	Address selection and I <sup>2</sup> C disable	29

---

9.3	I <sup>2</sup> C bus interface . . . . .	29
9.3.1	Data validity . . . . .	29
9.3.2	Start and stop conditions . . . . .	30
9.3.3	Byte format . . . . .	30
9.3.4	Acknowledge . . . . .	30
<b>10</b>	<b>Software specifications . . . . .</b>	<b>31</b>
<b>11</b>	<b>Examples of bytes sequence . . . . .</b>	<b>36</b>
<b>12</b>	<b>Package information . . . . .</b>	<b>37</b>
<b>13</b>	<b>Revision history . . . . .</b>	<b>41</b>

## List of tables

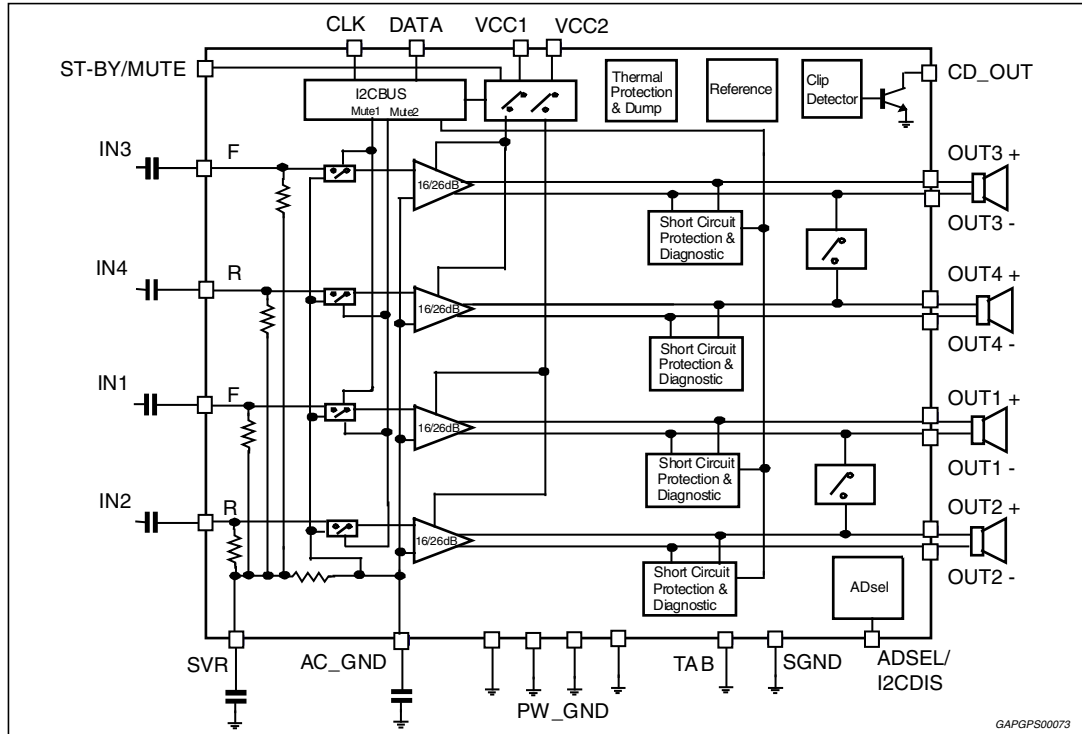
Table 1.	Device summary . . . . .	1
Table 2.	Pin list description . . . . .	9
Table 3.	Absolute maximum ratings . . . . .	10
Table 4.	Thermal data . . . . .	10
Table 5.	Electrical characteristics . . . . .	11
Table 6.	Double fault table for turn on diagnostic . . . . .	23
Table 7.	IB1 . . . . .	31
Table 8.	IB2 . . . . .	32
Table 9.	DB1 . . . . .	32
Table 10.	DB2 . . . . .	33
Table 11.	DB3 . . . . .	34
Table 12.	DB4 . . . . .	35
Table 13.	Document revision history . . . . .	41

## List of figures

Figure 1.	Block diagram . . . . .	6
Figure 2.	Application circuit . . . . .	6
Figure 3.	Application circuit (TDA75610LVDP) . . . . .	7
Figure 4.	Pin connection diagram of the Flexiwatt27 (top of view). . . . .	8
Figure 5.	Pin connection diagram of the PowerSO36 slug up (top of view). . . . .	8
Figure 6.	Quiescent current vs. supply voltage . . . . .	15
Figure 7.	Output power vs. supply voltage (4 $\Omega$ ) . . . . .	15
Figure 8.	Output power vs. supply voltage (2 $\Omega$ ) . . . . .	15
Figure 9.	Distortion vs. output power (4 $\Omega$ , STD) . . . . .	15
Figure 10.	Distortion vs. output power (4 $\Omega$ , HI-EFF) . . . . .	15
Figure 11.	Distortion vs. output power (2 $\Omega$ , STD) . . . . .	15
Figure 12.	Distortion vs. output power (2 $\Omega$ , HI-EFF) . . . . .	16
Figure 13.	Distortion vs. output power $V_s = 6\text{ V}$ (4 $\Omega$ , STD) . . . . .	16
Figure 14.	Distortion vs. frequency (4 $\Omega$ ) . . . . .	16
Figure 15.	Distortion vs. frequency (2 $\Omega$ ) . . . . .	16
Figure 16.	Crosstalk vs. frequency . . . . .	16
Figure 17.	Supply voltage rejection vs. frequency . . . . .	16
Figure 18.	Power dissipation vs. average output power (audio program simulation, 4 $\Omega$ ) . . . . .	17
Figure 19.	Power dissipation vs. average output power (audio program simulation, 2 $\Omega$ ) . . . . .	17
Figure 20.	Total power dissipation and efficiency vs. output power (4 $\Omega$ , HI-EFF, Sine) . . . . .	17
Figure 21.	Total power dissipation and efficiency vs. output power (4 $\Omega$ , STD, Sine) . . . . .	17
Figure 22.	ITU R-ARM frequency response, weighting filter for transient pop . . . . .	17
Figure 23.	Turn-on diagnostic: working principle . . . . .	18
Figure 24.	SVR and output behavior (Case 1: without turn-on diagnostic) . . . . .	18
Figure 25.	SVR and output pin behavior (Case 2: with turn-on diagnostic) . . . . .	19
Figure 26.	Short circuit detection thresholds . . . . .	19
Figure 27.	Load detection thresholds - high gain setting . . . . .	19
Figure 28.	Load detection threshold - low gain setting . . . . .	19
Figure 29.	Restart timing without diagnostic enable (permanent) - Each 1 mS time, a sampling of the fault is done . . . . .	20
Figure 30.	Restart timing with diagnostic enable (permanent) . . . . .	20
Figure 31.	Current detection high: load impedance $ Z $ vs. output peak voltage . . . . .	22
Figure 32.	Current detection low: load impedance $ Z $ vs. output peak voltage . . . . .	22
Figure 33.	Thermal foldback diagram . . . . .	24
Figure 34.	Worst case battery cranking curve sample 1 . . . . .	25
Figure 35.	Worst case battery cranking curve sample 2 . . . . .	25
Figure 36.	Upwards fast battery transitions diagram . . . . .	26
Figure 37.	Inputs impedance matching circuit . . . . .	27
Figure 38.	High efficiency - basic structure . . . . .	28
Figure 39.	Data validity on the I <sup>2</sup> C bus . . . . .	30
Figure 40.	Timing diagram on the I <sup>2</sup> C bus . . . . .	30
Figure 41.	Acknowledge on the I <sup>2</sup> C bus . . . . .	30
Figure 42.	Flexiwatt27 (horizontal) mechanical data and package dimensions . . . . .	37
Figure 43.	Flexiwatt27 (vertical) mechanical data and package dimensions . . . . .	38
Figure 44.	Flexiwatt27 (SMD) mechanical data and package dimensions . . . . .	39
Figure 45.	PowerSO36 (slug up) mechanical data and package dimensions . . . . .	40

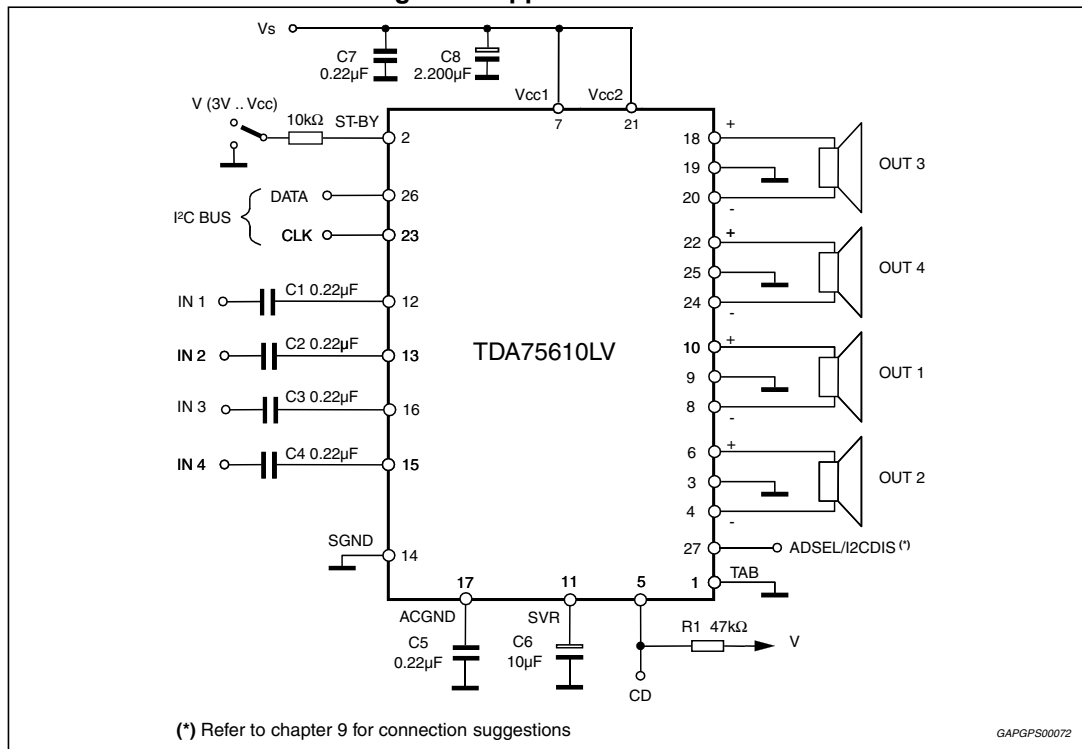
# 1 Block diagram and application circuits

Figure 1. Block diagram



GAPGPS00073

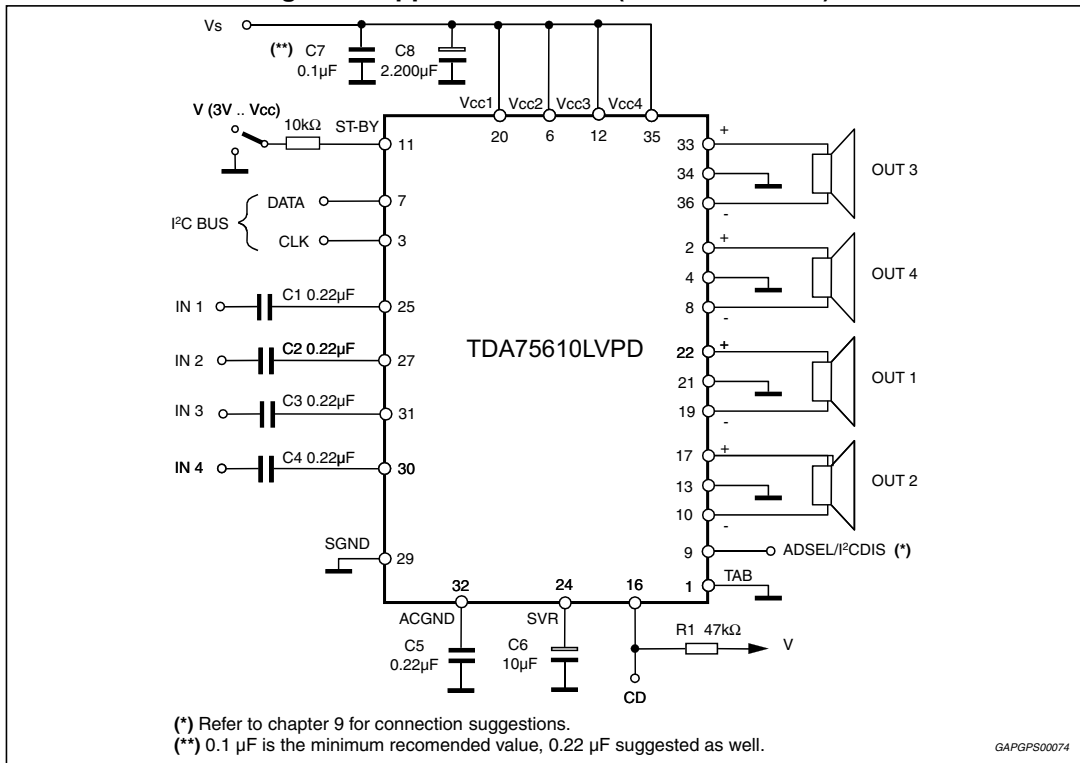
Figure 2. Application circuit



(\*) Refer to chapter 9 for connection suggestions

GAPGPS00073

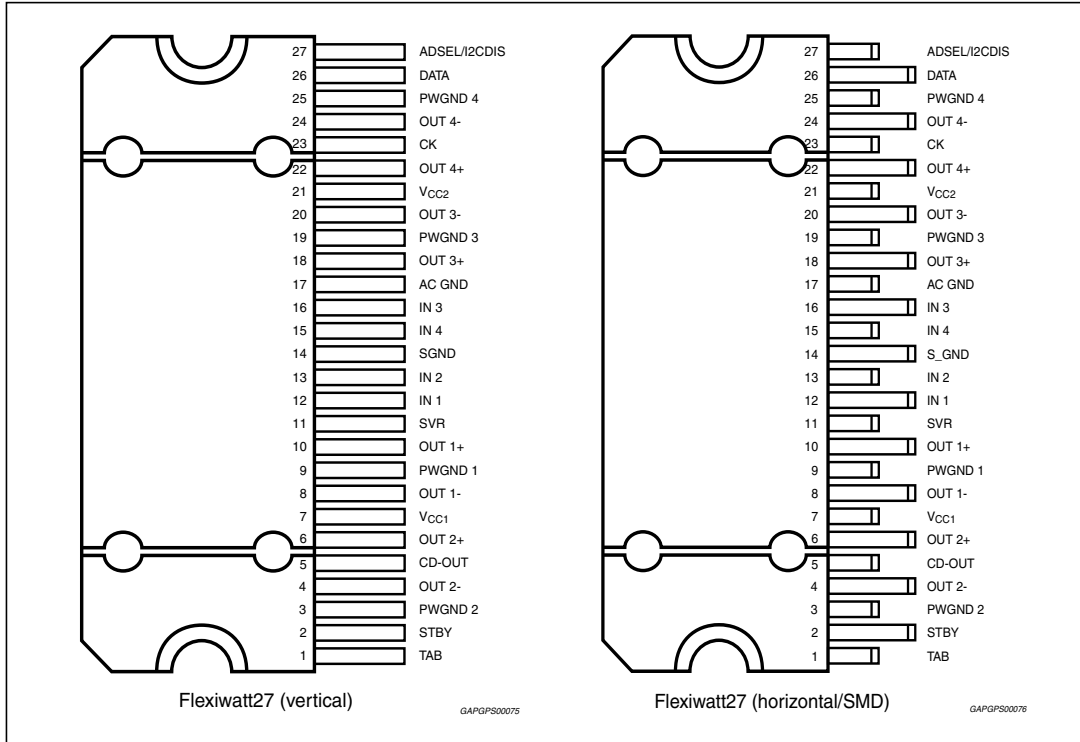
Figure 3. Application circuit (TDA75610LVPD)



## 2 Pin description

For channel name reference: CH1 = LF, CH2 = LR, CH3 = RF and CH4 = RR.

**Figure 4. Pin connection diagram of the Flexiwatt27 (top of view)**



**Figure 5. Pin connection diagram of the PowerSO36 slug up (top of view)**

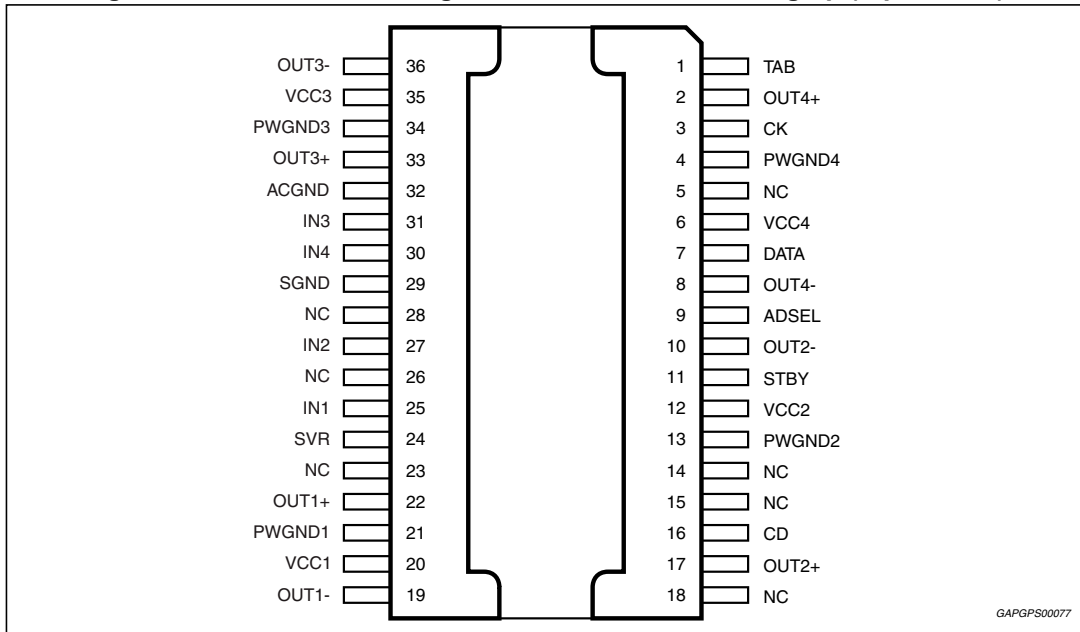




Table 2. Pin list description

Pin # (PowerSo36)	Pin # (Flexiwatt27)	Pin name	Function
1	1	TAB	-
2	22	OUT4+	Channel 4, + output
3	23	CK	I <sup>2</sup> C bus clock/HE selector
4	25	PWGND4	Channel 4 output power ground
5	-	NC	Not connected
6	-	VCC4	Supply voltage pin4
7	26	DATA	I <sup>2</sup> C bus data pin/gain selector
8	24	OUT4-	Channel 4, - output
9	27	ADSEL	Address selector pin/ I <sup>2</sup> C bus disable (legacy select)
10	4	OUT2-	Channel 2, - output
11	2	STBY	Standby pin
12	21	VCC2	Supply voltage pin2
13	3	PWGND2	Channel 2 output power ground
14	-	NC	Not connected
15	-	NC	Not connected
16	5	CD	Clip detector output pin
17	6	OUT2+	Channel 2, + output
18	-	NC	Not connected
19	8	OUT1-	Channel 1, - output
20	7	VCC1	Supply voltage pin1
21	9	PWGND1	Channel 1 output power ground
22	10	OUT1+	Channel 1, + output
23	-	NC	Not connected
24	11	SVR	SVR pin
25	12	IN1	Input pin, channel 1
26	-	NC	Not connected
27	13	IN2	Input pin, channel 2
28	-	NC	Not connected
29	14	SGND	Signal ground pin
30	15	IN4	Input pin, channel 4
31	16	IN3	Input pin, channel 3
32	17	AC GND	AC ground
33	18	OUT3+	Channel 3, + output
34	19	PWGND3	Channel 3 output power ground
35	-	VCC3	Supply voltage pin3
36	20	OUT3-	Channel 3, - output

### 3 Electrical specifications

#### 3.1 Absolute maximum ratings

Table 3. Absolute maximum ratings

Symbol	Parameter	Value	Unit
$V_{op}$	Operating supply voltage <sup>(1)</sup>	18	V
$V_S$	DC supply voltage	28	V
$V_{peak}$	Peak supply voltage (for $t_{max} = 50$ ms)	50	V
GNDmax	Ground pins voltage	-0.3 to 0.3	V
$V_{CK}, V_{DATA}$	CK and DATA pin voltage	-0.3 to 6	V
$V_{cd}$	Clip detector voltage	-0.3 to 5.5	V
$V_{stby}$	STBY pin voltage	-0.3 to $V_{op}$	V
$I_O$	Output peak current (not repetitive $t_{max} = 100$ ms)	8	A
	Output peak current (repetitive $f > 10$ kHz)	6	
$P_{tot}$	Power dissipation $T_{case} = 70^\circ\text{C}$	85	W
$T_{stg}, T_j$	Storage and junction temperature <sup>(2)</sup>	-55 to 150	$^\circ\text{C}$
$T_{amb}$	Operative temperature range	-40 to 105	$^\circ\text{C}$

1. For  $R_L = 2 \Omega$  the output current limit might be reached for  $V_{OP} > 16$  V; thus triggering sel-protection.

2. A suitable dissipation system should be used to keep  $T_j$  inside the specified limits.

#### 3.2 Thermal data

Table 4. Thermal data

Symbol	Parameter	PowerSO	Flexiwatt	Unit
$R_{th\ j-case}$	Thermal resistance junction-to-caseMax.	1	1	$^\circ\text{C/W}$

### 3.3 Electrical characteristics

Refer to the test circuit,  $V_S = 14.4\text{ V}$ ;  $R_L = 4\ \Omega$ ;  $f = 1\text{ kHz}$ ;  $G_V = 26\text{ dB}$ ;  $T_{\text{amb}} = 25\text{ }^\circ\text{C}$ ; unless otherwise specified.

Tested at  $T_{\text{amb}} = 25\text{ }^\circ\text{C}$  and  $T_{\text{hot}} = 105\text{ }^\circ\text{C}$ ; functionality guaranteed for  $T_J = -40\text{ }^\circ\text{C}$  to  $150\text{ }^\circ\text{C}$ .

**Table 5. Electrical characteristics**

Symbol	Parameter	Test condition	Min.	Typ.	Max.	Unit
<b>General characteristics</b>						
$V_S$	Supply voltage range	$R_L = 4\ \Omega$	6	-	18	V
		$R_L = 2\ \Omega$	6	-	16 <sup>(1)</sup>	
$I_d$	Total quiescent drain current	-	-	165	250	mA
$R_{IN}$	Input impedance	-	45	60	70	k $\Omega$
$V_{AM}$	Min. supply mute threshold	IB1(D7) = 1 Signal attenuation -6 dB	7	-	8	V
		IB1(D7) = 0 (default); <sup>(2)</sup> Signal attenuation -6 dB	5	-	5.8	
$V_{OS}$	Offset voltage	Mute & play	-80	0	80	mV
$V_{dth}$	Dump threshold	-	18.5	-	20.5	V
$I_{SB}$	Standby current	$V_{\text{standby}} = 0$	-	1	5	$\mu\text{A}$
SVR	Supply voltage rejection	$f = 100\text{ Hz to }10\text{ kHz}$ ; $V_r = 1\text{ Vpk}$ ; $R_g = 600\ \Omega$	60	70	-	dB
$T_{ON}$	Turn on timing (Mute play transition)	D2/D1 (IB1) 0 to 1	-	25	50	ms
$T_{OFF}$	Turn off timing (Play mute transition)	D2/D1 (IB1) 1 to 0	-	25	50	ms
$TH_{\text{WARN1}}$	Average junction temperature for TH warning 1	DB1 (D7) = 1	-	160	-	$^\circ\text{C}$
$TH_{\text{WARN2}}$	Average junction temperature for TH warning 2	DB4 (D7) = 1	-	145	-	
$TH_{\text{WARN3}}$	Average junction temperature for TH warning 3	DB4 (D6) = 1	-	125	-	
<b>Audio performances</b>						
$P_O$	Output power	Max. power <sup>(3)</sup> $V_S = 15.2\text{ V}$ , $R_L = 4\ \Omega$	-	45	-	W
		THD = 10 %, $R_L = 4\ \Omega$	23	25	-	W
		THD = 1 %, $R_L = 4\ \Omega$	-	22	-	W
		$R_L = 2\ \Omega$ ; THD 10 %	-	44	-	W
		$R_L = 2\ \Omega$ ; THD 1 %	-	33	-	W
		$R_L = 2\ \Omega$ ; Max. power <sup>(3)</sup> $V_S = 14.4\text{ V}$	-	64	-	W
		Max power@ $V_S = 6\text{ V}$ , $R_L = 4\ \Omega$	-	5	-	W

Table 5. Electrical characteristics (continued)

Symbol	Parameter	Test condition	Min.	Typ.	Max.	Unit
THD	Total harmonic distortion	$P_O = 1\text{ W to }10\text{ W}$ ; STD mode	-	0.015	0.1	%
		HE MODE; $P_O = 1.5\text{ W}$	-	0.05	0.1	%
		HE MODE; $P_O = 8\text{ W}$	-	0.1	0.5	%
		$P_O = 1\text{-}10\text{ W}$ , $f = 10\text{ kHz}$	-	0.15	0.5	%
		$G_V = 16\text{ dB}$ ; STD Mode $V_O = 0.1\text{ to }5\text{ VRMS}$	-	0.02	0.05	%
$C_T$	Cross talk	$f = 1\text{ kHz to }10\text{ kHz}$ , $R_g = 600\ \Omega$	50	65	-	dB
$G_{V1}$	Voltage gain 1	-	25	26	27	dB
$\Delta G_{V1}$	Voltage gain match 1	-	-1	-	1	dB
$G_{V2}$	Voltage gain 2	-	15	16	17	dB
$\Delta G_{V2}$	Voltage gain match 2	-	-1	-	1	dB
$E_{IN1}$	Output noise voltage 1	$R_g = 600\ \Omega$ 20 Hz to 22 kHz	-	45	60	$\mu\text{V}$
$E_{IN2}$	Output noise voltage 2	$R_g = 600\ \Omega$ ; $G_V = 16\text{ dB}$ 20 Hz to 22 kHz	-	20	30	$\mu\text{V}$
BW	Power bandwidth	-	100	-	-	kHz
CMRR	Input CMRR	$V_{CM} = 1\text{ Vpk-pk}$ ; $R_g = 0\ \Omega$	-	70	-	dB
$\Delta V_{OITU}$	ITU Pop filter output voltage	<b>Standby to Mute and Mute to Standby transition</b> $T_{amb} = 25\text{ }^\circ\text{C}$ , ITU-R 2K, $C_{svr} = 10\ \mu\text{F}$ $V_s = 14.4\text{ V}$	-7.5	-	+7.5	mV
		<b>Mute to Play transition</b> $T_{amb} = 25\text{ }^\circ\text{C}$ , ITU-R 2K, $V_s = 14.4\text{ V}^{(4)}$	-7.5	-	+7.5	mV
		<b>Play to Mute transition</b> $T_{amb} = 25\text{ }^\circ\text{C}$ , ITU-R 2K, $V_s = 14.4\text{ V}^{(5)}$	-7.5	-	+7.5	mV
<b>Clip detector</b>						
$CD_{LK}$	Clip det. high leakage current	CD off / $V_{CD} = 6\text{ V}$	-	0	5	$\mu\text{A}$
$CD_{SAT}$	Clip det sat. voltage	CD on; $I_{CD} = 1\text{ mA}$	-	-	300	mV
$CD_{THD}$	Clip det THD level	D0 (IB1) = 1	5	10	15	%
		D0 (IB1) = 0	1	2	3	%
<b>Control pin characteristics</b>						
$V_{SBY}$	Standby/mute pin for standby	-	0	-	1.2	V
$V_{MU}$	Standby/mute pin for mute	-	2.9	-	3.5	V
$V_{OP}$	Standby/mute pin for operating	-	4.5	-	18	V
$I_{MU}$	Standby/mute pin current	$V_{st-by/mute} = 4.5\text{ V}$	-	1	5	$\mu\text{A}$
		$V_{st-by/mute} < 1.2\text{ V}$	-	0	5	$\mu\text{A}$

Table 5. Electrical characteristics (continued)

Symbol	Parameter	Test condition	Min.	Typ.	Max.	Unit
$A_{SB}$	Standby attenuation	-	90	110	-	dB
$A_M$	Mute attenuation	-	80	100	-	dB
<b>Turn on diagnostics 1 (Power amplifier mode)</b>						
Pgnd	Short to GND det. (below this limit, the Output is considered in short circuit to GND)	Power amplifier in standby	-	-	1.2	V
Pvs	Short to Vs det. (above this limit, the output is considered in short circuit to Vs)		Vs -1.2	-	-	V
Pnop	Normal operation thresholds. (Within these limits, the output is considered without faults).		1.8	-	Vs -1.8	V
Lsc	Shorted load det.		-	-	0.5	$\Omega$
Lop	Open load det.		85	-	-	$\Omega$
Lnop	Normal load det.		1.5	-	45	$\Omega$
<b>Turn on diagnostics 2 (Line driver mode)</b>						
Pgnd	Short to GND det. (below this limit, the output is considered in short circuit to GND)	Power amplifier in standby	-	-	1.2	V
Pvs	Short to Vs det. (above this limit, the output is considered in short circuit to Vs)	-	Vs -1.2	-	-	V
Pnop	Normal operation thresholds. (Within these limits, the output is considered without faults).	-	1.8	-	Vs -1.8	V
Lsc	Shorted load det.	-	-	-	1.5	$\Omega$
Lop	Open load det.	-	330	-	-	$\Omega$
Lnop	Normal load det.	-	7	-	180	$\Omega$
<b>Permanent diagnostics 2 (Power amplifier mode or line driver mode)</b>						
Pgnd	Short to GND det. (below this limit, the Output is considered in short circuit to GND)	Power amplifier in mute or play, one or more short circuits protection activated	-	-	1.2	V
Pvs	Short to Vs det. (above this limit, the output is considered in short circuit to Vs)		Vs -1.2	-	-	V
Pnop	Normal operation thresholds. (Within these limits, the output is considered without faults).		1.8	-	Vs -1.8	V
L <sub>SC</sub>	Shorted load det.	Power amplifier mode	-	-	0.5	$\Omega$
		Line driver mode	-	-	1.5	$\Omega$

**Table 5. Electrical characteristics (continued)**

Symbol	Parameter	Test condition	Min.	Typ.	Max.	Unit
$V_O$	Offset detection	Power amplifier in play, AC input signals = 0	$\pm 1.5$	$\pm 2$	$\pm 2.5$	V
$I_{NLH}$	Normal load current detection	$V_O < (V_S - 5)\mu\text{V}$ , IB2 (D7) = 0	500	-	-	mA
$I_{OLH}$	Open load current detection		-	-	250	mA
$I_{NLL}$	Normal load current detection	$V_O < (V_S - 5)\mu\text{V}$ , IB2 (D7) = 1	250	-	-	mA
$I_{OLL}$	Open load current detection		-	-	125	mA
<b>I<sup>2</sup>C bus interface</b>						
$S_{CL}$	Clock frequency	-	-	-	400	kHz
$V_{IL}$	Input low voltage	-	-	-	1.5	V
$V_{IH}$	Input high voltage	-	2.3	-	-	V

1. When  $V_S > 16$  V the output current limit is reached (triggering embedded internal protections).
2. In legacy mode only low threshold option is available.
3. Saturated square wave output.
4. Voltage ramp on STBY pin:  
from 3.3 V to 4.2 V in  $t \geq 40$  ms.  
In case of I<sup>2</sup>C mode command IB1(D1) = 1 (Mute → Unmute rear channels) and/or IB1(D2) = 1 (Mute → Unmute front channels) must be transmitted before to start the voltage ramp on STBY pin.
5. Voltage ramp on STBY pin:  
from 4.05 V to 3.55 V in  $t \geq 40$  ms.  
In case of I<sup>2</sup>C mode command IB1(D1) = 0 (Unmute → Mute rear channels) and/or IB1(D2) = 0 (Unmute → Mute front channels) must be NOT transmitted before to start the voltage ramp on STBY pin.

### 3.4 Typical electrical characteristics curves

Figure 6. Quiescent current vs. supply voltage

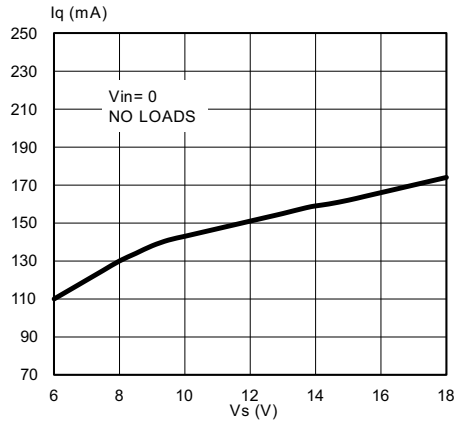


Figure 7. Output power vs. supply voltage (4  $\Omega$ )

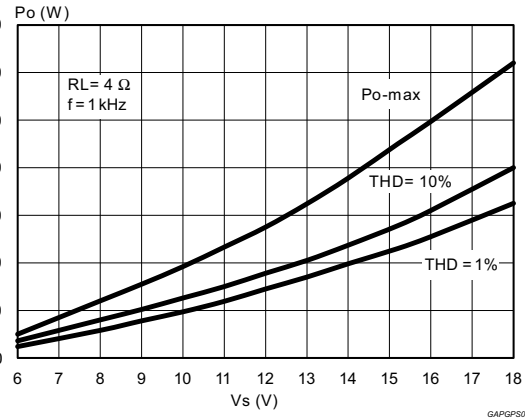


Figure 8. Output power vs. supply voltage (2  $\Omega$ )

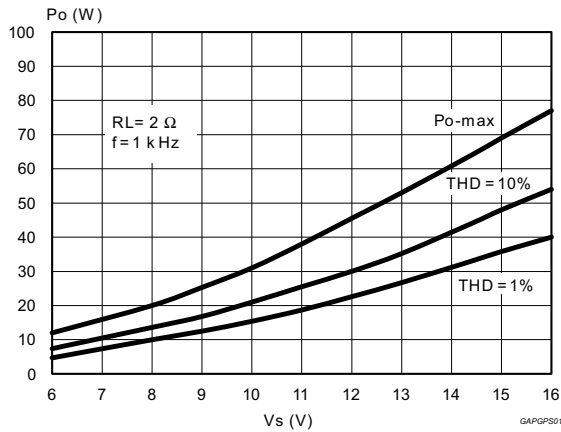


Figure 9. Distortion vs. output power (4  $\Omega$ , STD)

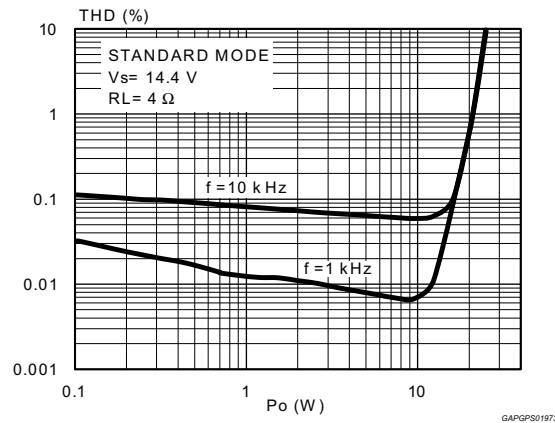


Figure 10. Distortion vs. output power (4  $\Omega$ , HI-EFF)

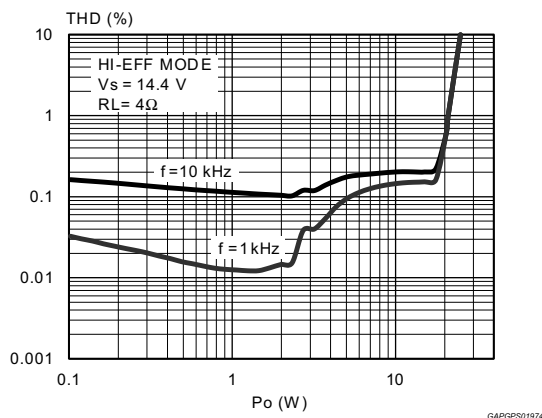
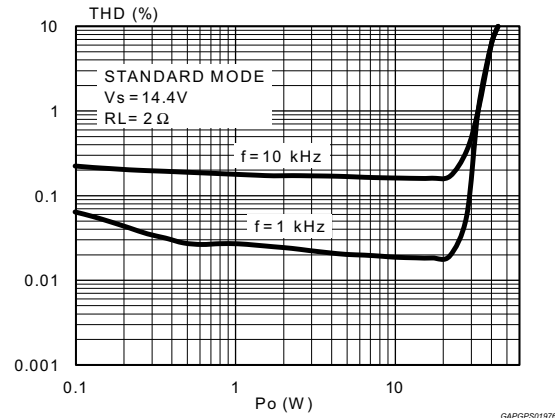
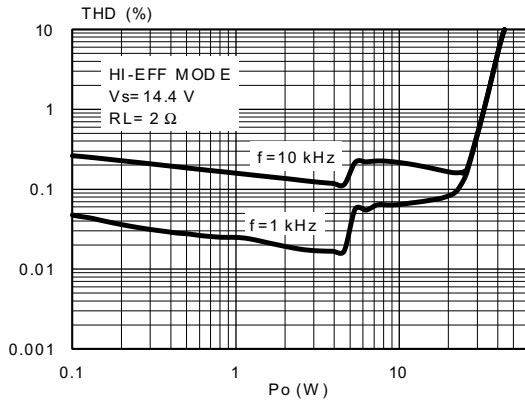


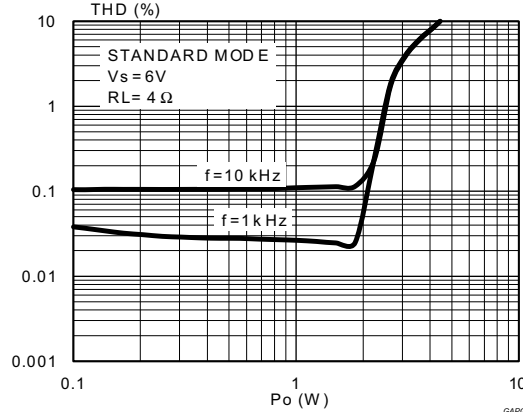
Figure 11. Distortion vs. output power (2  $\Omega$ , STD)



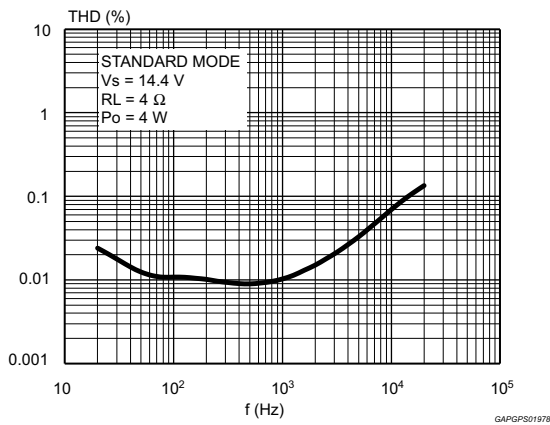
**Figure 12. Distortion vs. output power (2 Ω, HI-EFF)**



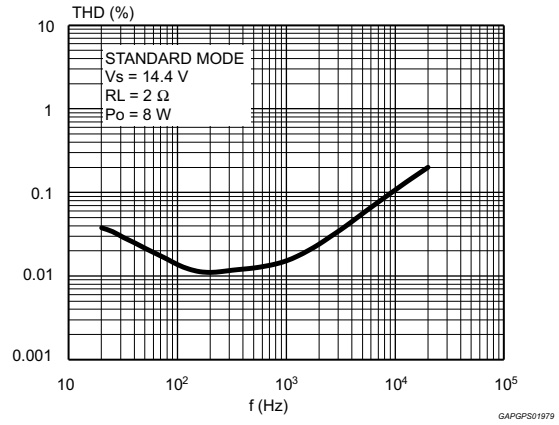
**Figure 13. Distortion vs. output power  $V_s = 6\text{ V}$  (4 Ω, STD)**



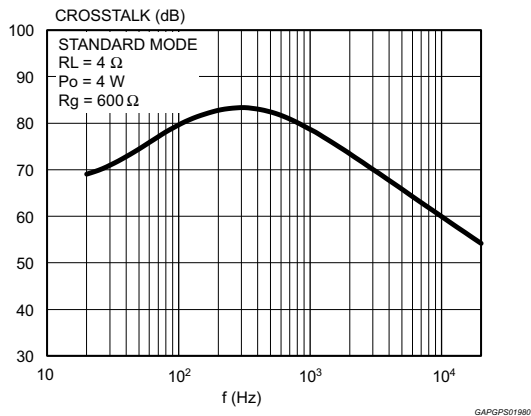
**Figure 14. Distortion vs. frequency (4 Ω)**



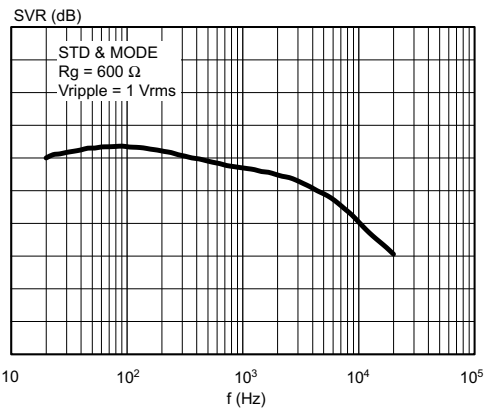
**Figure 15. Distortion vs. frequency (2 Ω)**



**Figure 16. Crosstalk vs. frequency**

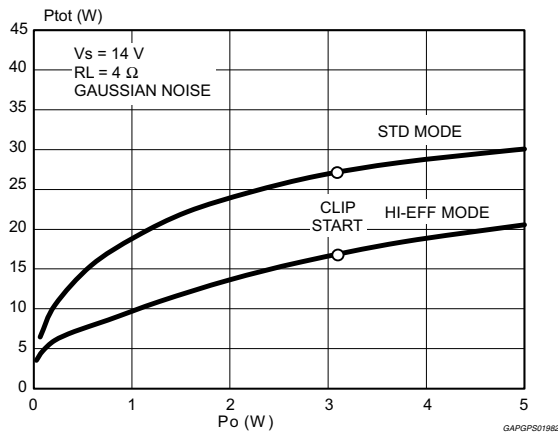


**Figure 17. Supply voltage rejection vs. frequency**

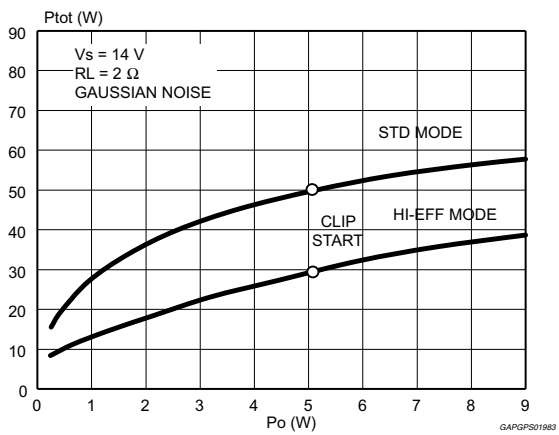




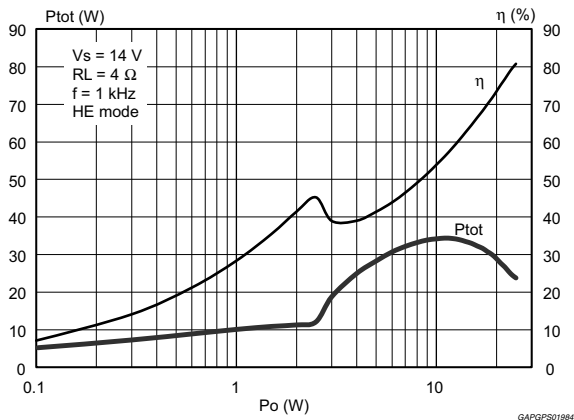
**Figure 18. Power dissipation vs. average output power (audio program simulation, 4 Ω)**



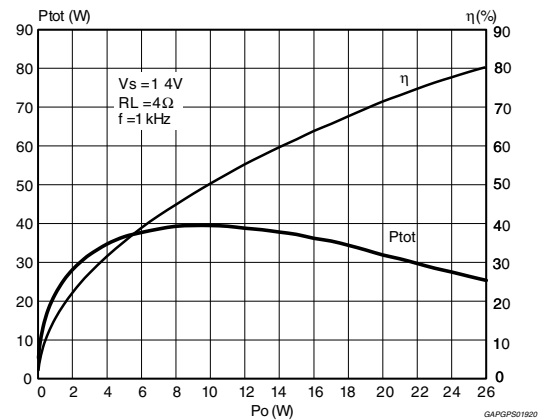
**Figure 19. Power dissipation vs. average output power (audio program simulation, 2 Ω)**



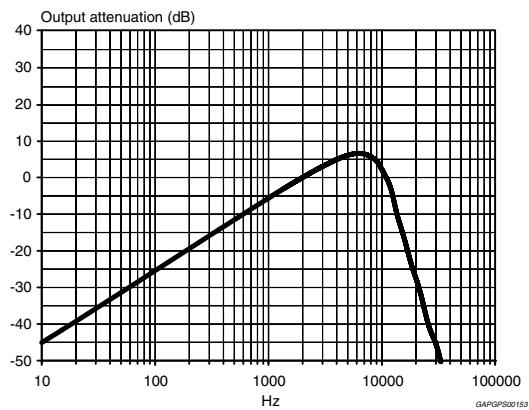
**Figure 20. Total power dissipation and efficiency vs. output power (4 Ω, HI-EFF, Sine)**



**Figure 21. Total power dissipation and efficiency vs. output power (4 Ω, STD, Sine)**



**Figure 22. ITU R-ARM frequency response, weighting filter for transient pop**



## 4 Diagnostics functional description

### 4.1 Turn-on diagnostic

It is recommended to activate this function at the turn-on (standby out) through an I<sup>2</sup>C bus request. Detectable output faults are:

- SHORT TO GND
- SHORT TO VS
- SHORT ACROSS THE SPEAKER
- OPEN SPEAKER

To verify if any of the above misconnections are in place, a subsonic (inaudible) current pulse (Figure 23) is internally generated, sent through the speaker(s) and sunk back. The Turn On diagnostic status is internally stored until a successive diagnostic pulse is requested (after a I<sup>2</sup>C reading).

If the "standby out" and "diag. enable" commands are both given through a single programming step, the pulse takes place first (during the pulse the power stage stays 'off', showing high impedance at the outputs).

Afterwards, when the amplifier is biased, the PERMANENT diagnostic takes place. The previous turn-on state is kept until a short appears at the outputs.

**Figure 23. Turn-on diagnostic: working principle**

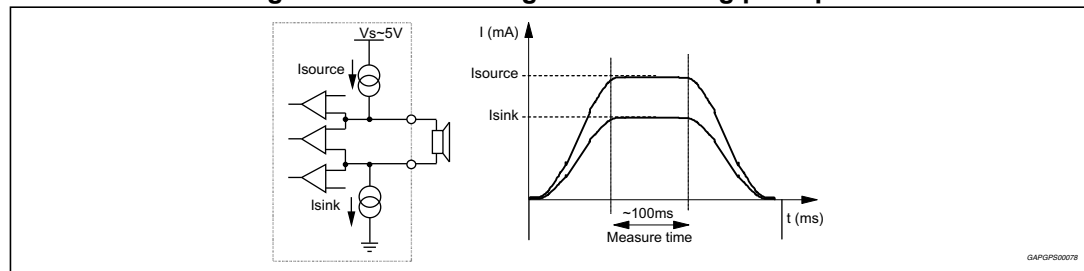


Figure 24 and 25 show SVR and OUTPUT waveforms at the turn-on (standby out) with and without turn-on diagnostic.

**Figure 24. SVR and output behavior (Case 1: without turn-on diagnostic)**

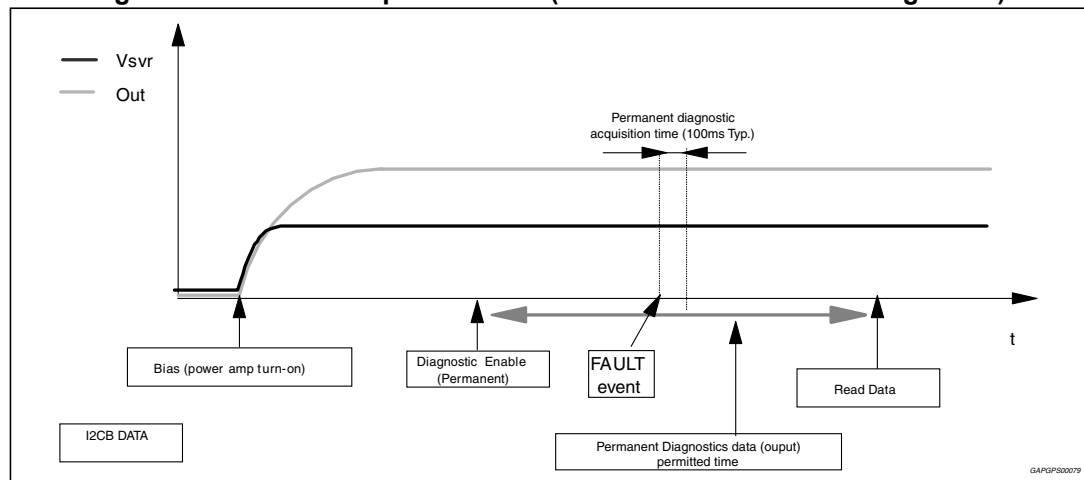
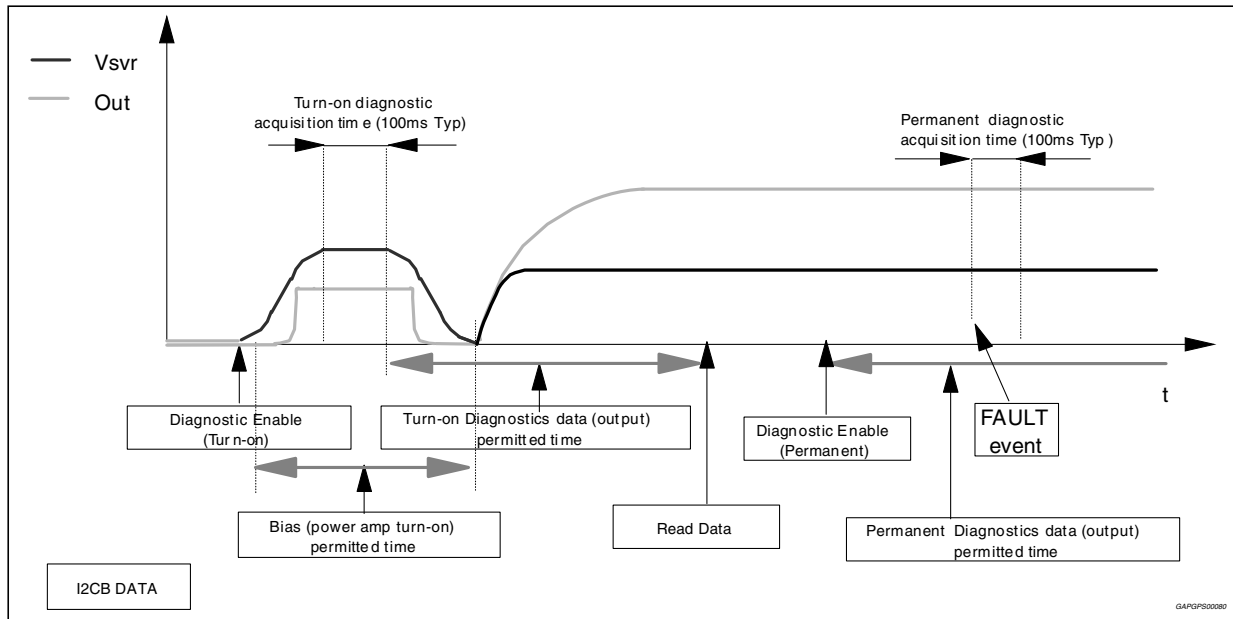
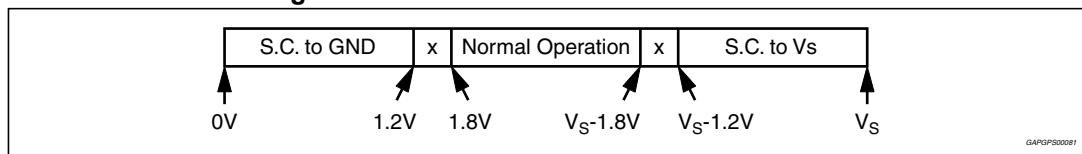


Figure 25. SVR and output pin behavior (Case 2: with turn-on diagnostic)



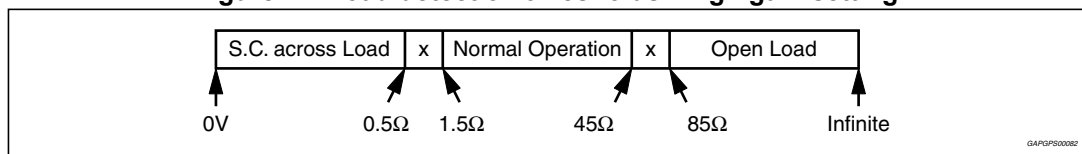
The information related to the outputs status is read and memorized at the end of the current pulse plateau. The acquisition time is 100 ms (typ.). No audible noise is generated in the process. As for SHORT TO GND / Vs the fault-detection thresholds remain unchanged from 26 dB to 16 dB gain setting. They are as follows:

Figure 26. Short circuit detection thresholds



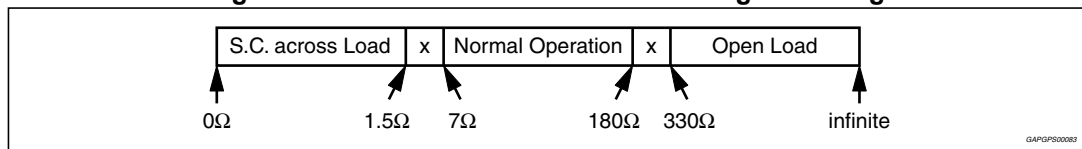
Concerning SHORT ACROSS THE SPEAKER / OPEN SPEAKER, the threshold varies from 26 dB to 16 dB gain setting, since different loads are expected (either normal speaker's impedance or high impedance). The values in case of 26 dB gain are as follows:

Figure 27. Load detection thresholds - high gain setting



If the Line-Driver mode (Gv= 16 dB and Line Driver Mode diagnostic = 1) is selected, the same thresholds will change as follows:

Figure 28. Load detection threshold - low gain setting



## 4.2 Permanent diagnostics

Detectable conventional faults are:

- Short to GND
- Short to Vs
- Short across the speaker

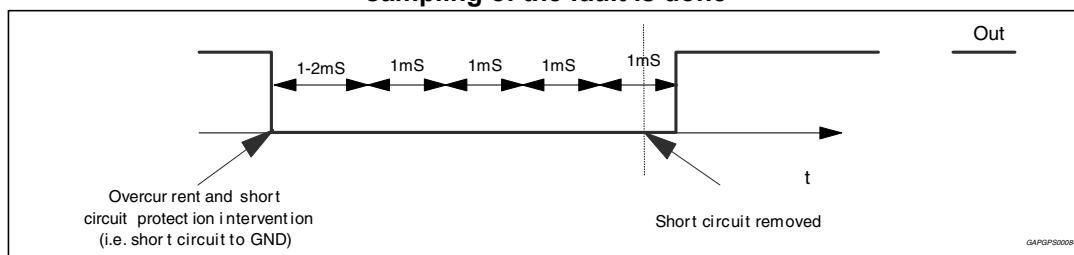
The following additional feature is provided:

- Output offset detection

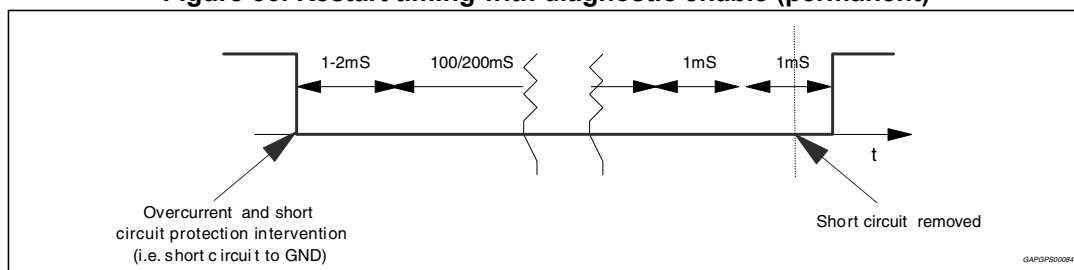
The TDA75610LV has 2 operating status:

1. **RESTART mode.** The diagnostic is not enabled. Each audio channel operates independently of each other. If any of the a.m. faults occurs, only the channel(s) interested is shut down. A check of the output status is made every 1 ms (*Figure 29*). Restart takes place when the overload is removed.
2. **DIAGNOSTIC mode.** It is enabled via I<sup>2</sup>C bus and it self activates if an output overload (such as to cause the intervention of the short-circuit protection) occurs to the speakers outputs. Once activated, the diagnostics procedure develops as follows (*Figure 30*):
  - To avoid momentary re-circulation spikes from giving erroneous diagnostics, a check of the output status is made after 1ms: if normal situation (no overloads) is detected, the diagnostic is not performed and the channel returns active.
  - Instead, if an overload is detected during the check after 1 ms, then a diagnostic cycle having a duration of about 100 ms is started.
  - After a diagnostic cycle, the audio channel interested by the fault is switched to RESTART mode. The relevant data are stored inside the device and can be read by the microprocessor. When one cycle has terminated, the next one is activated by an I<sup>2</sup>C reading. This is to ensure continuous diagnostics throughout the car-radio operating time.
  - To check the status of the device a sampling system is needed. The timing is chosen at microprocessor level (over half a second is recommended).

**Figure 29. Restart timing without diagnostic enable (permanent) - Each 1 mS time, a sampling of the fault is done**



**Figure 30. Restart timing with diagnostic enable (permanent)**



### 4.3 Output DC offset detection

Any DC output offset exceeding  $\pm 2$  V are signalled out. This inconvenient might occur as a consequence of initially defective or aged and worn-out input capacitors feeding a DC component to the inputs, so putting the speakers at risk of overheating.

This diagnostic has to be performed with low-level output AC signal (or  $V_{in} = 0$ ).

The test is run with selectable time duration by microprocessor (from a "start" to a "stop" command):

- START = Last reading operation or setting IB1 - D5 - (OFFSET enable) to 1
- STOP = Actual reading operation

Excess offset is signalled out if it is persistent of all the assigned testing time. This feature is disabled if any overloads leading to activation of the short-circuit protection occurs in the process.

### 4.4 AC diagnostic

It is targeted at detecting accidental disconnection of tweeters in 2-way speaker and, more in general, presence of capacitive (AC) coupled loads.

This diagnostic is based on the notion that the overall speaker's impedance (woofer + parallel tweeter) will tend to increase towards high frequencies if the tweeter gets disconnected, because the remaining speaker (woofer) would be out of its operating range (high impedance). The diagnostic decision is made according to peak output current thresholds, and it is enabled by setting (IB2-D2) = 1. Two different detection levels are available:

- High current threshold IB2 (D7) = 0
  - lout > 500 mApk = normal status
  - lout < 250 mApk = open tweeter
- Low current threshold IB2 (D7) = 1
  - lout > 250 mApk = normal status
  - lout < 125 mApk = open tweeter

To correctly implement this feature, it is necessary to briefly provide a signal tone (with the amplifier in "play") whose frequency and magnitude are such as to determine an output current higher than 500 mApk with IB2(D7) = 0 (higher than 250 mApk with IB2(D7) = 1) in normal conditions and lower than 250 mApk with IB2(D7) = 0 (lower than 125 mApk with IB2(D7)=1) should the parallel tweeter be missing.

The test has to last for a minimum number of 3 sine cycles starting from the activation of the AC diagnostic function IB2<D2> up to the I<sup>2</sup>C reading of the results (measuring period). To confirm presence of tweeter, it is necessary to find at least 3 current pulses over the above threshold over all the measuring period, else an "open tweeter" message will be issued.

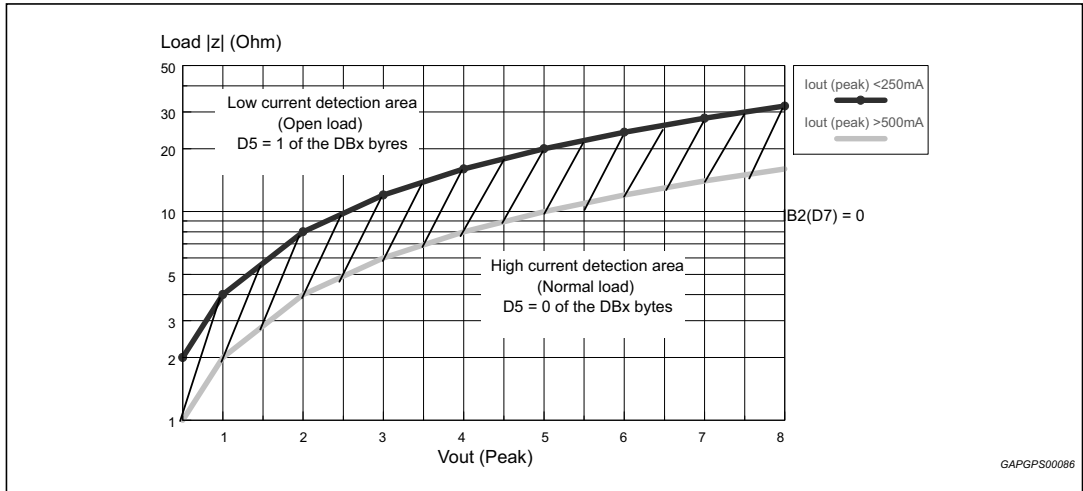
The frequency / magnitude setting of the test tone depends on the impedance characteristics of each specific speaker being used, with or without the tweeter connected (to be calculated case by case). High-frequency tones (> 10 kHz) or even ultrasonic signals are recommended for their negligible acoustic impact and also to maximize the impedance module's ratio between with tweeter-on and tweeter-off.

*Figure 31* and *32* shows the load impedance as a function of the peak output voltage and the relevant diagnostic fields.

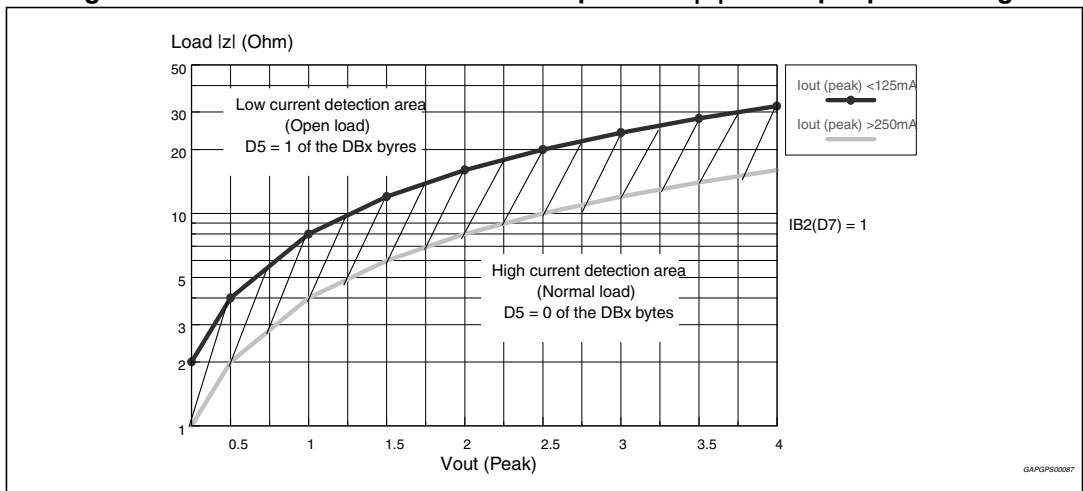
It is recommended to keep output voltage always below 8 V (high threshold case) or 4 V (low threshold case) to avoid the circuit to saturate (causing wrong detection cases).

This feature is disabled if any overloads leading to activation of the short-circuit protection occurs in the process.

**Figure 31. Current detection high: load impedance |Z| vs. output peak voltage**



**Figure 32. Current detection low: load impedance |Z| vs. output peak voltage**



## 5 Multiple faults

When more misconnections are simultaneously in place at the audio outputs, it is guaranteed that at least one of them is initially read out. The others are notified after successive cycles of I<sup>2</sup>C reading and faults removal, provided that the diagnostic is enabled. This is true for both kinds of diagnostic (Turn on and Permanent).

The table below shows all the couples of double-fault possible. It should be taken into account that a short circuit with the 4 ohm speaker unconnected is considered as double fault.

**Table 6. Double fault table for turn on diagnostic**

	S. GND	S. Vs	S. Across L.	Open L.
S. GND	S. GND	S. Vs + S. GND	S. GND	S. GND
S. Vs	/	S. Vs	S. Vs	S. Vs
S. Across L.	/	/	S. Across L.	N.A.
Open L.	/	/	/	Open L. (*)

In Permanent Diagnostic the table is the same, with only a difference concerning Open Load(\*), which is not among the recognizable faults. Should an Open Load be present during the device's normal working, it would be detected at a subsequent Turn on Diagnostic cycle (i.e. at the successive Car Radio Turn on).

### 5.1 Faults availability

All the results coming from I<sup>2</sup>C bus, by read operations, are the consequence of measurements inside a defined period of time. If the fault is stable throughout the whole period, it will be sent out.

To guarantee always resident functions, every kind of diagnostic cycles (Turn on, Permanent, Offset) will be reactivate after any I<sup>2</sup>C reading operation. So, when the micro reads the I<sup>2</sup>C, a new cycle will be able to start, but the read data will come from the previous diag. cycle (i.e. The device is in Turn On state, with a short to Gnd, then the short is removed and micro reads I<sup>2</sup>C. The short to Gnd is still present in bytes, because it is the result of the previous cycle. If another I<sup>2</sup>C reading operation occurs, the bytes do not show the short). In general to observe a change in Diagnostic bytes, two I<sup>2</sup>C reading operations are necessary.

## 6 Thermal protection

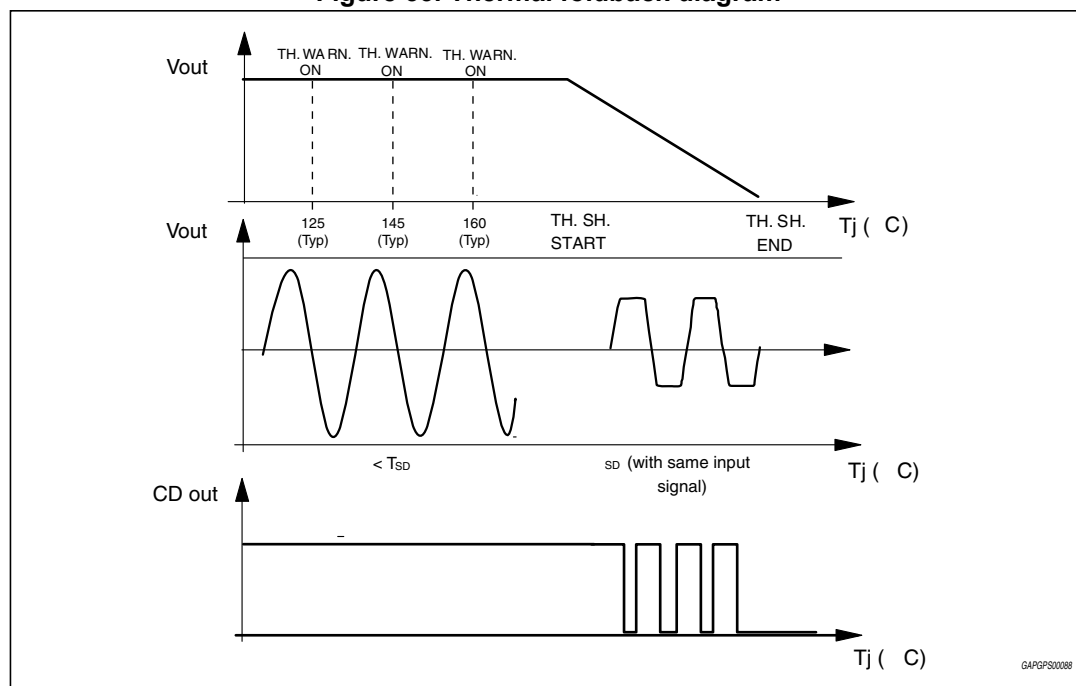
Thermal protection is implemented through thermal foldback (*Figure 33*).

Thermal foldback begins limiting the audio input to the amplifier stage as the junction temperatures rise above the normal operating range. This effectively limits the output power capability of the device thus reducing the temperature to acceptable levels without totally interrupting the operation of the device.

The output power will decrease to the point at which thermal equilibrium is reached. Thermal equilibrium will be reached when the reduction in output power reduces the dissipated power such that the die temperature falls below the thermal foldback threshold. Should the device cool, the audio level will increase until a new thermal equilibrium is reached or the amplifier reaches full power. Thermal foldback will reduce the audio output level in a linear manner.

Three thermal warning are available through the I<sup>2</sup>C bus data. After thermal shut down threshold is reached, the CD could toggle (as shown in *Figure 33*) or stay low, depending on signal level.

**Figure 33. Thermal foldback diagram**



### 6.1 Fast muting

The muting time can be shortened to less than 1.5 ms by setting (IB2) D5 = 1. This option can be useful in transient battery situations (i.e. during car engine cranking) to quickly turnoff the amplifier to avoid any audible effects caused by noise/transients being injected by preamp stages. The bit must be set back to “0” shortly after the mute transition.



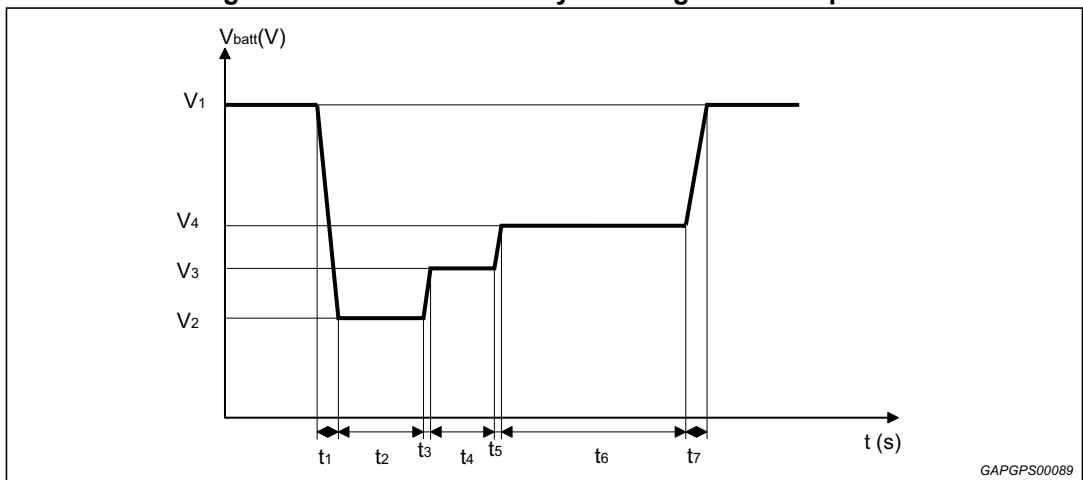
## 7 Battery transitions management

### 7.1 Low voltage operation (“start stop”)

The most recent OEM specifications are requiring automatic stop of car engine at traffic light, in order to reduce emissions of polluting substances. The TDA75610LV, thanks to its innovating design, allows to go on playing sound when battery falls down to 6/7V during such conditions, without producing pop noise. The maximum system power will be reduced accordingly.

Supported battery cranking curves are shown below, indicating the shape and durations of allowed battery transitions.

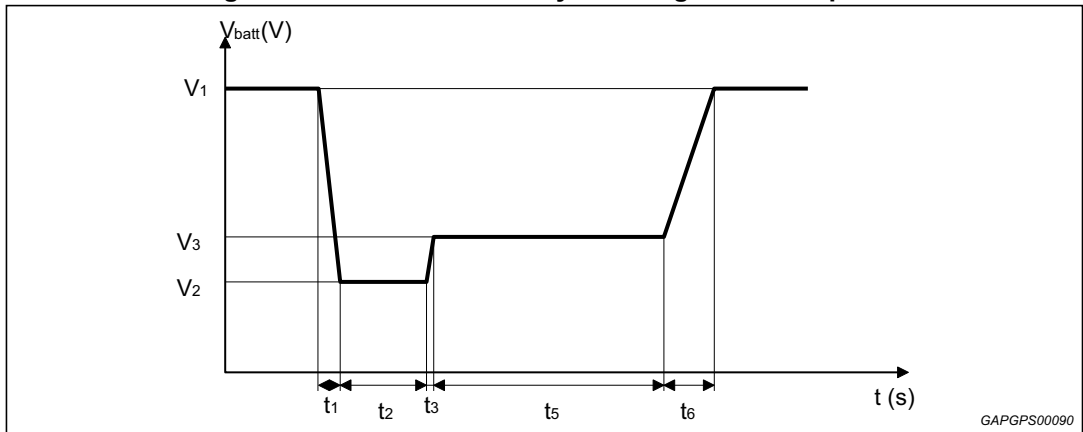
**Figure 34. Worst case battery cranking curve sample 1**



$V_1 = 12\text{ V}; V_2 = 6\text{ V}; V_3 = 7\text{ V}; V_4 = 8\text{ V}$

$t_1 = 2\text{ ms}; t_2 = 50\text{ ms}; t_3 = 5\text{ ms}; t_4 = 300\text{ ms}; t_5 = 10\text{ ms}; t_6 = 1\text{ s}; t_7 = 2\text{ ms}$

**Figure 35. Worst case battery cranking curve sample 2**



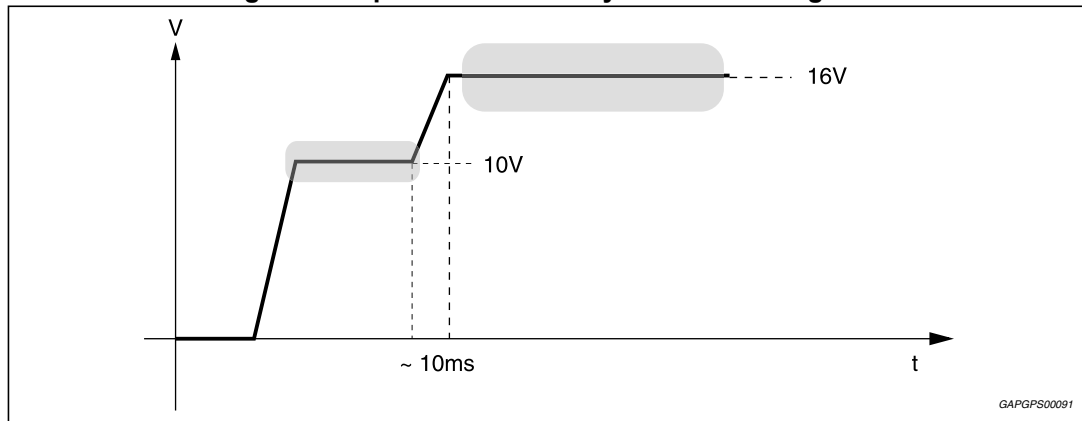
$V_1 = 12\text{ V}; V_2 = 6\text{ V}; V_3 = 7\text{ V}$

$t_1 = 2\text{ ms}; t_2 = 5\text{ ms}; t_3 = 15\text{ ms}; t_5 = 1\text{ s}; t_6 = 50\text{ ms}$

## 7.2 Advanced battery management

In addition to compatibility with low  $V_{\text{batt}}$ , the TDA75610LV is able to sustain upwards fast battery transitions (like the one showed in [Figure 36](#)) without causing unwanted audible effect, thanks to the innovative circuit topology.

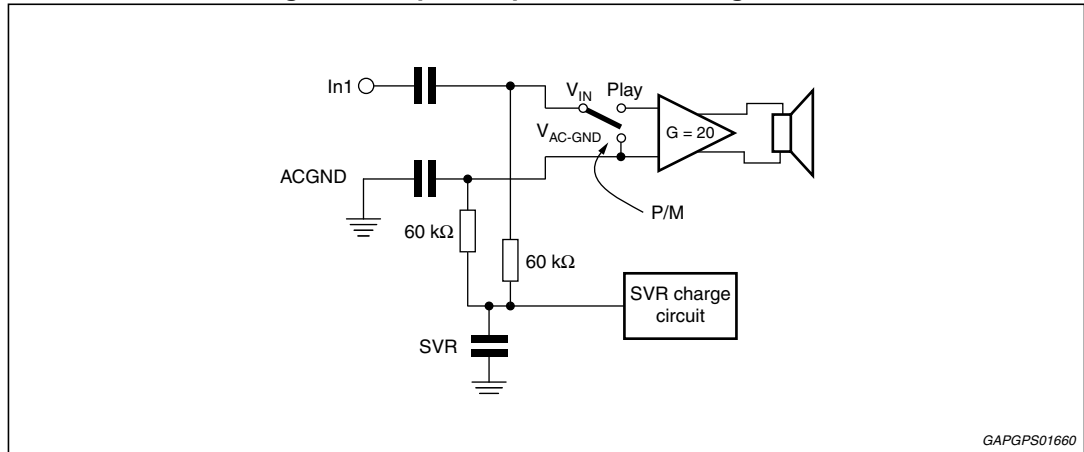
**Figure 36. Upwards fast battery transitions diagram**



## 8 Application suggestion

### 8.1 Inputs impedance matching

Figure 37. Inputs impedance matching circuit



The above is a simplified input stage where it is visible that the AC-GND impedance ( $60\text{ k}\Omega$ ) is the same as the input one.

During battery variations the SVR voltage is moved and  $V_{IN}$  and  $V_{AC-GND}$  tracks it through the two R-C networks.

Any differences of this two time constants can produce a differential input voltage, which can produce a noise.

Consequently, any additional passive components at the inputs (other than the input capacitors) such as series resistance or R dividers must be compensated for at AC-GND level by connecting the same equivalent resistance in series to  $C_{AC-GND}$ .

A good 1:1 matching ( $Z_{AC-GND} = Z_{IN}$ ) is therefore recommended to minimize pop. This rule applies to both "4-CH operation" and "2-CH operation", as any unused input has to be AC-grounded (through the same  $C_{IN}$  value).

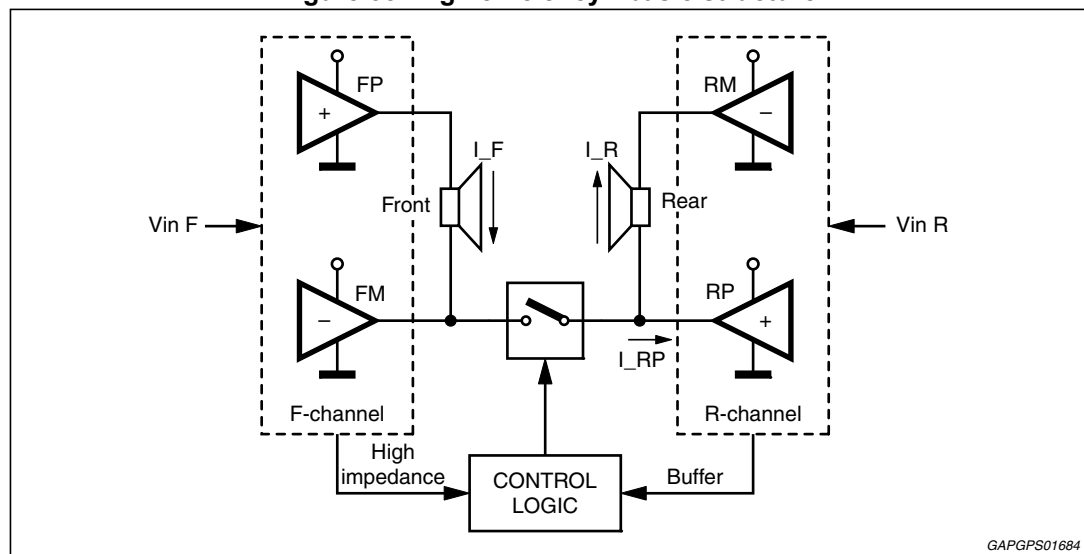
## 8.2 High efficiency introduction

Thanks to its operating principle, the TDA75610LV obtains a substantial reduction of power dissipation from traditional class-AB amplifiers without being affected by the massive radiation effects and complex circuitry normally associated with class-D solutions.

The high efficiency operating principle is based on the use of bridge structures which are connected by means of a power switch. In particular, as shown in *Figure 1*, Ch1 is linked to Ch2, while Ch3 to Ch4. The switch, controlled by a logic circuit which senses the input signals, is closed at low volumes (output power steadily lower than 2.5 W) and the system acts like a "single bridge" with double load. In this case, the total power dissipation is a quarter of a double bridge.

Due to its structure, the highest efficiency level can be reached when symmetrical loads are applied on channels sharing the same switch.

**Figure 38. High efficiency - basic structure**



When the power demand increases to more than 2.5 W, the system behavior is switched back to a standard double bridge in order to guarantee the maximum output power, while in the 6 V start-stop devices the High Efficiency mode is automatically disabled at low  $V_{CC}$  ( $7.3\text{ V} \pm 0.3\text{ V}$ ). No need to re-program it when  $V_{CC}$  goes back to normal levels.

In the range 2-4 W (@  $V_{CC} = 14.4\text{ V}$ ,  $R_L = 4\ \Omega$ ), with the High Efficiency mode, the dissipated power gets up to 50 % less than the value obtained with the standard mode.

## 9 I<sup>2</sup>C bus

### 9.1 I<sup>2</sup>C programming/reading sequences

A correct turn on/off sequence with respect to the diagnostic timings and producing no audible noises could be as follows (after battery connection):

- TURN-ON: PIN2 > 4.5 V --- 10 ms --- (STAND-BY OUT + DIAG ENABLE) --- 1 s (min) --- MUTING OUT
- TURN-OFF: MUTING IN - wait for 50 ms - HW ST-BY IN (ST-BY pin ≤ 1.2 V)
- Car Radio Installation: PIN2 > 4.5 V --- 10 ms DIAG ENABLE (write) --- 200 ms --- I<sup>2</sup>C read (repeat until All faults disappear).
- OFFSET TEST: Device in Play (no signal) -- OFFSET ENABLE - 30 ms - I<sup>2</sup>C reading (repeat I<sup>2</sup>C reading until high-offset message disappears).

### 9.2 Address selection and I<sup>2</sup>C disable

When the ADSEL/I2CDIS pin is left open the I<sup>2</sup>C bus is disabled and the device can be controlled by the STBY/MUTE pin.

In this status (no - I<sup>2</sup>C bus) the CK pin enables the HIGH-EFFICIENCY MODE (0 = STD MODE; 1 = HE MODE) and the DATA pin sets the gain (0 = 26 dB; 1 = 16 dB).

When the ADSEL/I2CDIS pin is connected to GND the I<sup>2</sup>C bus is active with address <1101100-x>.

To select the other I<sup>2</sup>C address a resistor must be connected to ADSEL/I2CDIS pin as following:

0 < R < 1 kΩ: I<sup>2</sup>C bus active with address <1101100x>

11 kΩ < R < 21 kΩ: I<sup>2</sup>C bus active with address <1101101x>

40 kΩ < R < 70 kΩ: I<sup>2</sup>C bus active with address <1101110x>

R > 120 kΩ Legacy mode

(x: read/write bit sector)

### 9.3 I<sup>2</sup>C bus interface

Data transmission from microprocessor to the TDA75610LV and viceversa takes place through the 2 wires I<sup>2</sup>C bus interface, consisting of the two lines SDA and SCL (pull-up resistors to positive supply voltage must be connected).

#### 9.3.1 Data validity

As shown by [Figure 39](#), the data on the SDA line must be stable during the high period of the clock. The HIGH and LOW state of the data line can only change when the clock signal on the SCL line is LOW.

### 9.3.2 Start and stop conditions

As shown by *Figure 40* a start condition is a HIGH to LOW transition of the SDA line while SCL is HIGH. The stop condition is a LOW to HIGH transition of the SDA line while SCL is HIGH.

### 9.3.3 Byte format

Every byte transferred to the SDA line must contain 8 bits. Each byte must be followed by an acknowledge bit. The MSB is transferred first.

### 9.3.4 Acknowledge

The transmitter\* puts a resistive HIGH level on the SDA line during the acknowledge clock pulse (see *Figure 41*). The receiver\*\* has to pull-down (LOW) the SDA line during the acknowledge clock pulse, so that the SDA line is stable LOW during this clock pulse.

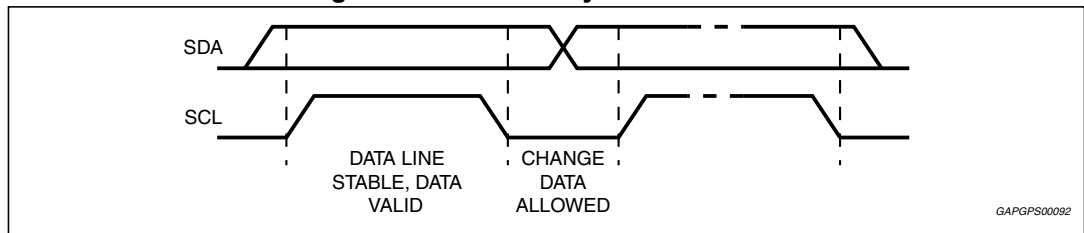
\* Transmitter

- master ( $\mu$ P) when it writes an address to the TDA75610LV
- slave (TDA75610LV) when the  $\mu$ P reads a data byte from TDA75610LV

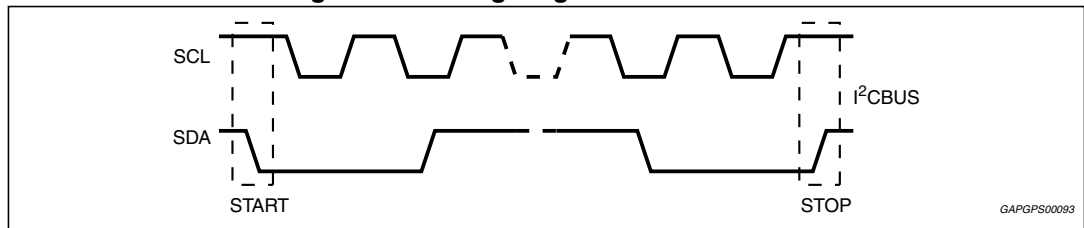
\*\* Receiver

- slave (TDA75610LV) when the  $\mu$ P writes an address to the TDA75610LV
- master ( $\mu$ P) when it reads a data byte from TDA75610LV

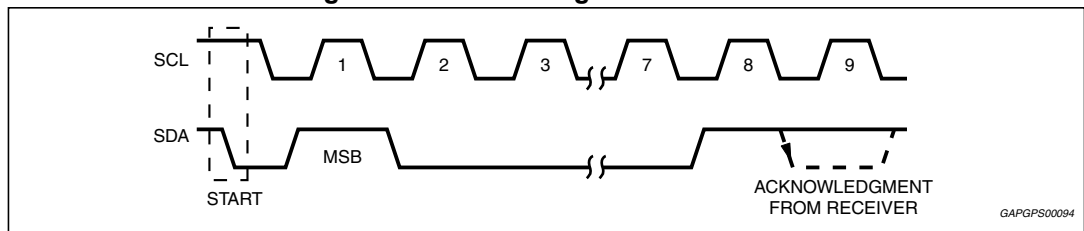
**Figure 39. Data validity on the I<sup>2</sup>C bus**



**Figure 40. Timing diagram on the I<sup>2</sup>C bus**



**Figure 41. Acknowledge on the I<sup>2</sup>C bus**



# 10 Software specifications

All the functions of the TDA75610LV are activated by I<sup>2</sup>C interface.

The bit 0 of the "ADDRESS BYTE" defines if the next bytes are write instruction (from μP to TDA75610LV) or read instruction (from TDA75610LV to μP).

### Chip address

D7							D0	
1	1	0	1	1	(*)	(*)	X	D8 Hex

X = 0 Write to device

X = 1 Read from device

If R/W = 0, the μP sends 2 "Instruction Bytes": IB1 and IB2.

(\*) address selector bit, please refer to address selection description on [Chapter 9.2](#).

**Table 7. IB1**

Bit	Instruction decoding bit
D7	Supply transition mute threshold high (D7 = 1) Supply transition mute threshold low (D7 = 0)
D6	Diagnostic enable (D6 = 1) Diagnostic defeat (D6 = 0)
D5	Offset Detection enable (D5 = 1) Offset Detection defeat (D5 = 0)
D4	Front Channel (CH1, CH3) Gain = 26 dB (D4 = 0) Gain = 16 dB (D4 = 1)
D3	Rear Channel (CH2, CH4) Gain = 26 dB (D3 = 0) Gain = 16 dB (D3 = 1)
D2	Mute front channels (D2 = 0) Unmute front channels (D2 = 1)
D1	Mute rear channels (D1 = 0) Unmute rear channels (D1 = 1)
D0	CD 2% (D0 = 0) CD 10% (D0 = 1)

**Table 8. IB2**

Bit	Instruction decoding bit
D7	Current detection threshold High th (D7 = 0) Low th (D7 =1)
D6	0
D5	Normal muting time (D5 = 0) Fast muting time (D5 = 1)
D4	Stand-by on - Amplifier not working - (D4 = 0) Stand-by off - Amplifier working - (D4 = 1)
D3	Power amplifier mode diagnostic (D3 = 0) Line driver mode diagnostic (D3 = 1)
D2	Current Detection Diagnostic Enabled (D2 =1) Current Detection Diagnostic Defeat (D2 =0)
D1	Right Channel Power amplifier working in standard mode (D1 = 0) Power amplifier working in high efficiency mode (D1 = 1)
D0	Left Channel Power amplifier working in standard mode (D0 = 0) Power amplifier working in high efficiency mode (D0 = 1)

If R/W = 1, the TDA75610LV sends 4 "Diagnostics Bytes" to  $\mu$ P: DB1, DB2, DB3 and DB4.

**Table 9. DB1**

Bit	Instruction decoding bit	
D7	Thermal warning 1 active (D7 = 1), $T_j = 160\text{ }^\circ\text{C}$ (Typ) -	
D6	Diag. cycle not activated or not terminated (D6 = 0) Diag. cycle terminated (D6 = 1) -	
D5	Channel LF (CH1) Current detection IB2 (D7) = 0 Output peak current < 250 mA - Open load (D5 = 1) Output peak current > 500 mA - Normal load (D5 = 0)	Channel LF (CH1) Current detection IB2 (D7) = 1 Output peak current < 125 mA - Open load (D5 = 1) Output peak current > 250 mA - Normal load (D5 = 0)
D4	Channel LF (CH1) Turn-on diagnostic (D4 = 0) Permanent diagnostic (D4 = 1) -	
D3	Channel LF (CH1) Normal load (D3 = 0) Short load (D3 = 1) -	
D2	Channel LF (CH1) Turn-on diag.: No open load (D2 = 0) Open load detection (D2 = 1) Offset diag.: No output offset (D2 = 0) Output offset detection (D2 = 1) -	



Table 9. DB1 (continued)

Bit	Instruction decoding bit	
D1	Channel LF (CH1) No short to Vcc (D1 = 0) Short to Vcc (D1 = 1)	-
D0	Channel LF (CH1) No short to GND (D1 = 0) Short to GND (D1 = 1)	-

Table 10. DB2

Bit	Instruction decoding bit	
D7	Offset detection not activated (D7 = 0) Offset detection activated (D7 = 1)	-
D6	X	-
D5	Channel LR (CH2) Current detection IB2 (D7) = 0 Output peak current < 250 mA - Open load (D5 = 1) Output peak current > 500 mA - Normal load (D5 = 0)	Channel LR (CH2) Current detection IB2 (D7) = 1 Output peak current < 125 mA - Open load (D5 = 1) Output peak current > 250 mA - Normal load (D5 = 0)
D4	Channel LR (CH2) Turn-on diagnostic (D4 = 0) Permanent diagnostic (D4 = 1)	-
D3	Channel LR (CH2) Normal load (D3 = 0) Short load (D3 = 1)	-
D2	Channel LR (CH2) Turn-on diag.: No open load (D2 = 0) Open load detection (D2 = 1) Permanent diag.: No output offset (D2 = 0) Output offset detection (D2 = 1)	-
D1	Channel LR (CH2) No short to Vcc (D1 = 0) Short to Vcc (D1 = 1)	-
D0	Channel LR (CH2) No short to GND (D1 = 0) Short to GND (D1 = 1)	-

Table 11. DB3

Bit	Instruction decoding bit	
D7	Standby status (= IB2 - D4)	-
D6	Diagnostic status (= IB1 - D6)	-
D5	Channel RF (CH3) Current detection IB2 (D7) = 0 Output peak current < 250 mA - Open load (D5 = 1) Output peak current > 500 mA - Normal load (D5 = 0)	Channel RF (CH3) Current detection IB2 (D7) = 1 Output peak current < 125 mA - Open load (D5 = 1) Output peak current > 250 mA - Normal load (D5 = 0)
D4	Channel RF (CH3) Turn-on diagnostic (D4 = 0) Permanent diagnostic (D4 = 1)	-
D3	Channel RF (CH3) Normal load (D3 = 0) Short load (D3 = 1)	-
D2	Channel RF (CH3) Turn-on diag.: No open load (D2 = 0) Open load detection (D2 = 1) Permanent diag.: No output offset (D2 = 0) Output offset detection (D2 = 1)	-
D1	Channel RF (CH3) No short to Vcc (D1 = 0) Short to Vcc (D1 = 1)	-
D0	Channel RF (CH3) No short to GND (D1 = 0) Short to GND (D1 = 1)	-

Table 12. DB4

Bit	Instruction decoding bit	
D7	Thermal warning 2 active (D7 = 1), $T_j = 145\text{ °C}$ (Typ)	-
D6	Thermal warning 3 active (D6 = 1) $T_j = 125\text{ °C}$ (Typ)	-
D5	Channel RR (CH4) Current detection IB2 (D7) = 0 Output peak current < 250 mA - Open load (D5 = 1) Output peak current > 500 mA - Normal load (D5 = 0)	Channel RR (CH4) Current detection IB2 (D7) = 1 Output peak current < 125 mA - Open load (D5 = 1) Output peak current > 250 mA - Normal load (D5 = 0)
D4	Channel RR (CH4) Turn-on diagnostic (D4 = 0) Permanent diagnostic (D4 = 1)	-
D3	Channel R (CH4) R Normal load (D3 = 0) Short load (D3 = 1)	-
D2	Channel RR (CH4) Turn-on diag.: No open load (D2 = 0) Open load detection (D2 = 1) Permanent diag.: No output offset (D2 = 0) Output offset detection (D2 = 1)	-
D1	Channel RR (CH4) No short to Vcc (D1 = 0) Short to Vcc (D1 = 1)	-
D0	Channel RR (CH4) No short to GND (D1 = 0) Short to GND (D1 = 1)	-

# 11 Examples of bytes sequence

1 - Turn-On diagnostic - Write operation

Start	Address byte with D0 = 0	ACK	IB1 with D6 = 1	ACK	IB2	ACK	STOP
-------	--------------------------	-----	-----------------	-----	-----	-----	------

2 - Turn-On diagnostic - Read operation

Start	Address byte with D0 = 1	ACK	DB1	ACK	DB2	ACK	DB3	ACK	DB4	ACK	STOP
-------	--------------------------	-----	-----	-----	-----	-----	-----	-----	-----	-----	------

The delay from 1 to 2 can be selected by software, starting from 1ms

3a - Turn-On of the power amplifier with 26dB gain, mute on, diagnostic defeat, CD = 2%

Start	Address byte with D0 = 0	ACK	IB1	ACK	IB2	ACK	STOP
			X0000000		XXX1XX11		

3b - Turn-Off of the power amplifier

Start	Address byte with D0 = 0	ACK	IB1	ACK	IB2	ACK	STOP
			X0XXXXXX		XXX0XXXX		

4 - Offset detection procedure enable

Start	Address byte with D0 = 0	ACK	IB1	ACK	IB2	ACK	STOP
			XX1XX11X		XXX1XXXX		

5 - Offset detection procedure stop and reading operation (the results are valid only for the offset detection bits (D2 of the bytes DB1, DB2, DB3, DB4)

Start	Address byte with D0 = 1	ACK	DB1	ACK	DB2	ACK	DB3	ACK	DB4	ACK	STOP
-------	--------------------------	-----	-----	-----	-----	-----	-----	-----	-----	-----	------

- The purpose of this test is to check if a D.C. offset (2V typ.) is present on the outputs, produced by input capacitor with anomalous leakage current or humidity between pins.
- The delay from 4 to 5 can be selected by software, starting from 1ms

# 12 Package information

In order to meet environmental requirements, ST offers these devices in different grades of ECOPACK® packages, depending on their level of environmental compliance. ECOPACK® specifications, grade definitions and product status are available at: [www.st.com](http://www.st.com).

ECOPACK® is an ST trademark.

**Figure 42. Flexiwatt27 (horizontal) mechanical data and package dimensions**

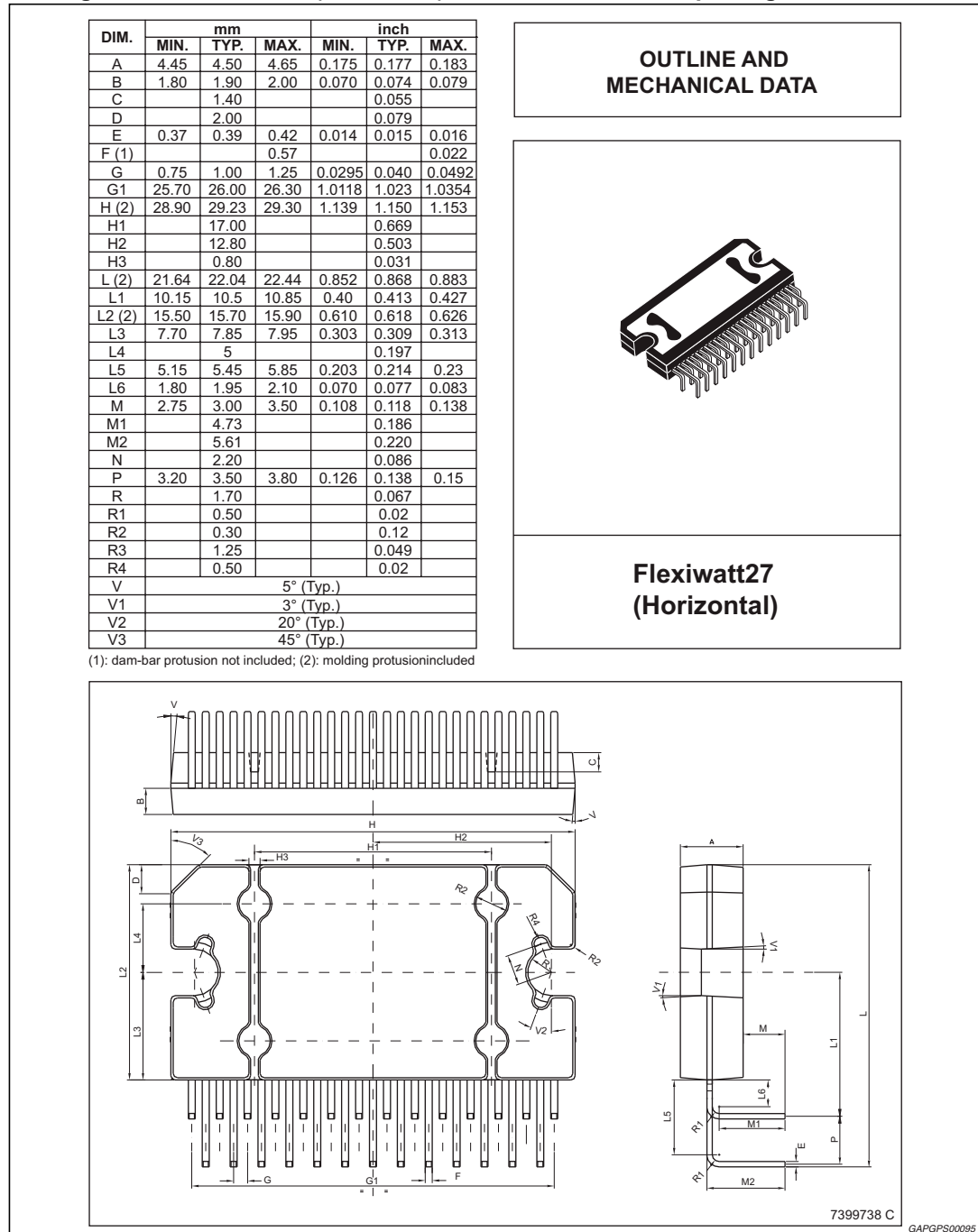
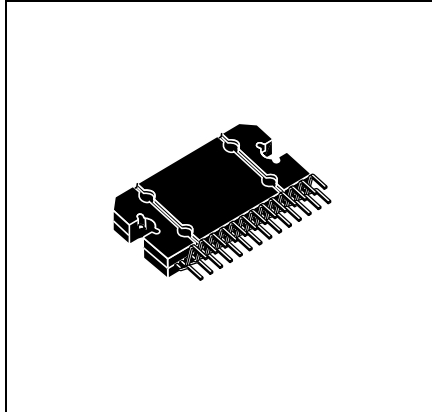


Figure 43. Flexiwatt27 (vertical) mechanical data and package dimensions

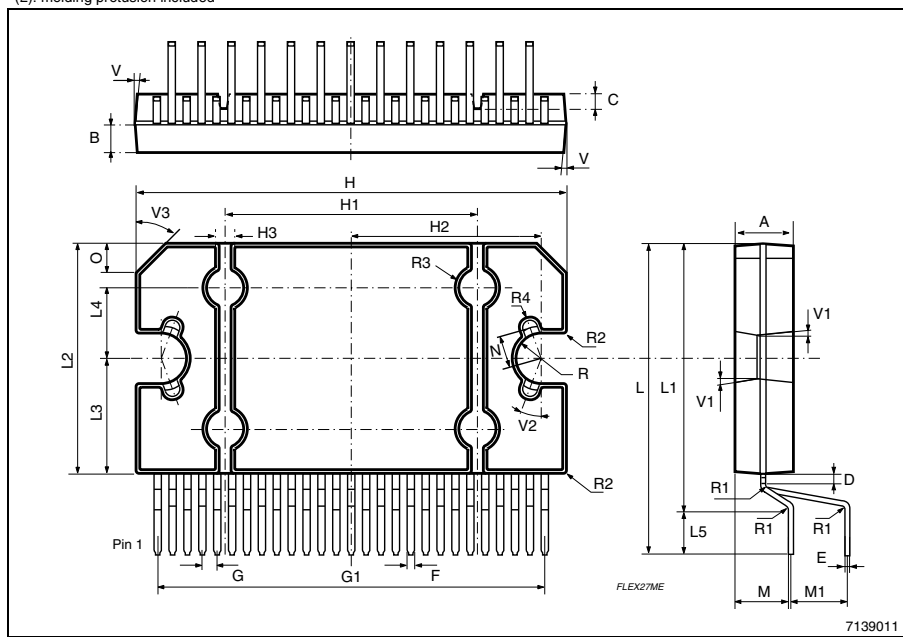
DIM.	mm			inch		
	MIN.	TYP.	MAX.	MIN.	TYP.	MAX.
A	4.45	4.50	4.65	0.175	0.177	0.183
B	1.80	1.90	2.00	0.070	0.074	0.079
C		1.40			0.055	
D	0.75	0.90	1.05	0.029	0.035	0.041
E	0.37	0.39	0.42	0.014	0.015	0.016
F (1)			0.57			0.022
G	0.80	1.00	1.20	0.031	0.040	0.047
G1	25.75	26.00	26.25	1.014	1.023	1.033
H (2)	28.90	29.23	29.30	1.139	1.150	1.153
H1		17.00			0.669	
H2		12.80			0.503	
H3		0.80			0.031	
L (2)	22.07	22.47	22.87	0.869	0.884	0.904
L1	18.57	18.97	19.37	0.731	0.747	0.762
L2 (2)	15.50	15.70	15.90	0.610	0.618	0.626
L3	7.70	7.85	7.95	0.303	0.309	0.313
L4		5			0.197	
L5		3.5			0.138	
M	3.70	4.00	4.30	0.145	0.157	0.169
M1	3.60	4.00	4.40	0.142	0.157	0.173
N		2.20			0.086	
O		2			0.079	
R		1.70			0.067	
R1		0.5			0.02	
R2		0.3			0.12	
R3		1.25			0.049	
R4		0.50			0.019	
V					5° (Typ.)	
V1					3° (Typ.)	
V2					20° (Typ.)	
V3					45° (Typ.)	

OUTLINE AND MECHANICAL DATA



Flexiwatt27 (vertical)

(1): dam-bar protusion not included  
 (2): molding protusion included



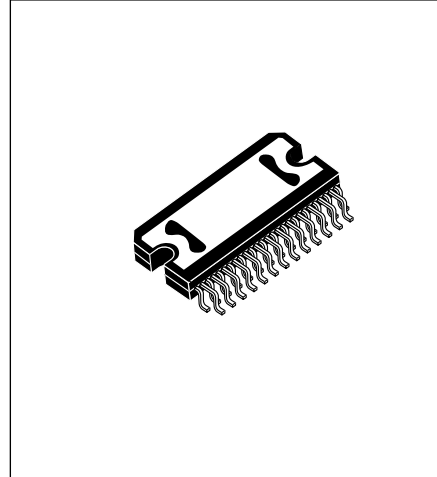
7139011

GAPGPS00096

Figure 44. Flexiwatt27 (SMD) mechanical data and package dimensions

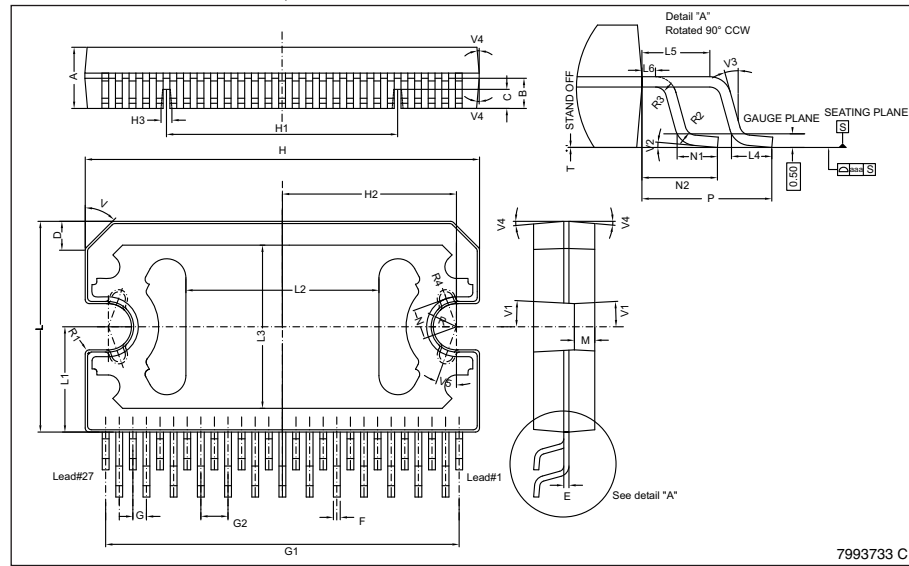
DIM.	mm			inch		
	MIN.	TYP.	MAX.	MIN.	TYP.	MAX.
A	4.45	4.50	4.65	0.1752	0.1772	0.1831
B	2.12	2.22	2.32	0.0835	0.0874	0.0913
C		1.40			0.0551	
D		2.00			0.0787	
E	0.36	0.40	0.44	0.0142	0.0157	0.0173
F(**)	0.47	0.51	0.57	0.0185	0.0201	0.0224
G(*)	0.75	1.00	1.25	0.0295	0.0394	0.0492
G1	25.70	26.00	26.30	1.0118	1.0236	1.0354
G2(*)	1.75	2.00	2.25	0.0689	0.0787	0.0886
H(**)	28.85	29.23	29.40	1.1358	1.1508	1.1575
H1		17.00			0.6693	
H2		12.80			0.5039	
H3		0.80			0.0315	
L(**)	15.50	15.70	15.90	0.6102	0.6181	0.6260
L1	7.70	7.85	7.95	0.3031	0.3091	0.3130
L2	14.00	14.20	14.40	0.5512	0.5591	0.5669
L3	11.80	12.00	12.20	0.4646	0.4724	0.4803
L4	1.30	1.48	1.66	0.0512	0.0583	0.0654
L5	2.42	2.50	2.58	0.0953	0.0984	0.1016
L6	0.42	0.50	0.58	0.0165	0.0197	0.0228
M		1.50			0.0591	
N		2.20			0.0866	
N1	1.30	1.48	1.66	0.0512	0.0583	0.0654
N2(*)	2.73	2.83	2.93	0.1075	0.1114	0.1154
P(*)	4.73	4.83	4.93	0.1862	0.1902	0.1941
R		1.70			0.0669	
R1		0.30			0.0118	
R2	0.35	0.40	0.45	0.0138	0.0157	0.0177
R3	0.35	0.40	0.45	0.0138	0.0157	0.0177
R4		0.50			0.0197	
T(*)	-0.08		0.10	-0.0031		0.0039
aaa(*)		0.1			0.0039	
V		45°			45°	
V1		3°			3°	
V2	3°	5°	7°	3°	5°	7°
V3	12°	15°	18°	12°	15°	18°
V4		5°			5°	
V5		20°			20°	

OUTLINE AND MECHANICAL DATA



Flexiwatt27 (SMD)

(\*) Golden parameters  
 (\*\*) Dimension "F" doesn't include dam-bar protrusion.  
 - Dimensions "H" and "L" include mold flash or protrusions.

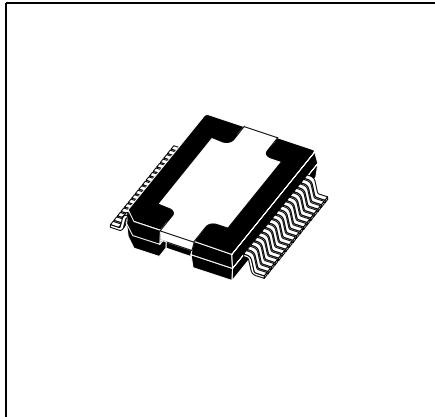


7993733 C  
 GAPGPS00087

Figure 45. PowerSO36 (slug up) mechanical data and package dimensions

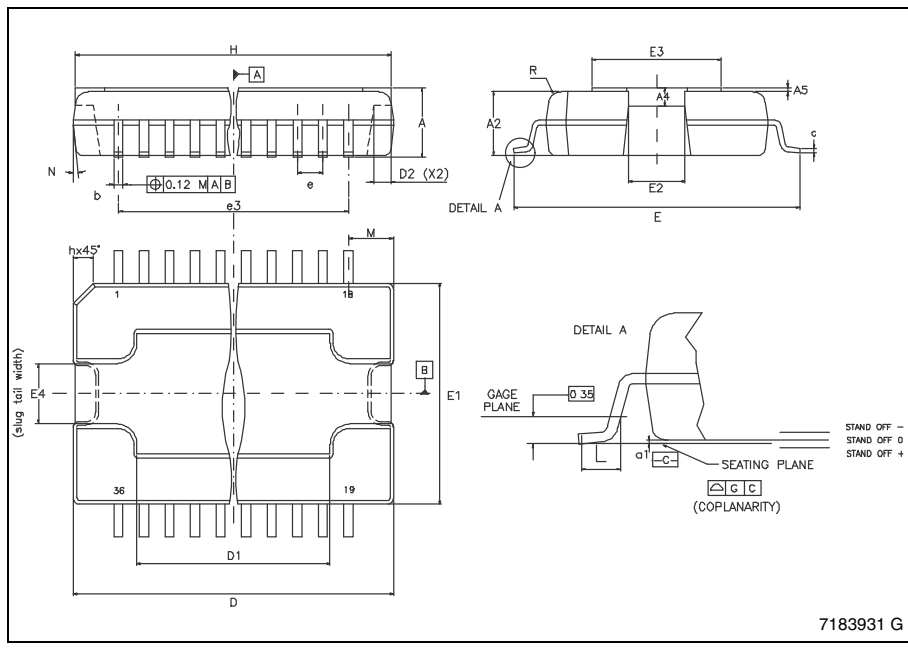
DIM.	mm			inch		
	MIN.	TYP.	MAX.	MIN.	TYP.	MAX.
A	3.270	-	3.410	0.1287	-	0.1343
A2	3.100	-	3.180	0.1220	-	0.1252
A4	0.800	-	1.000	0.0315	-	0.0394
A5	-	0.200	-	-	0.0079	-
a1	0.030	-	-0.040	0.0012	-	-0.0016
b	0.220	-	0.380	0.0087	-	0.0150
c	0.230	-	0.320	0.0091	-	0.0126
D	15.800	-	16.000	0.6220	-	0.6299
D1	9.400	-	9.800	0.3701	-	0.3858
D2	-	1.000	-	-	0.0394	-
E	13.900	-	14.500	0.5472	-	0.5709
E1	10.900	-	11.100	0.4291	-	0.4370
E2	-	-	2.900	-	-	0.1142
E3	5.800	-	6.200	0.2283	-	0.2441
E4	2.900	-	3.200	0.1142	-	0.1260
e	-	0.650	-	-	0.0256	-
e3	-	11.050	-	-	0.4350	-
G	0	-	0.075	0	-	0.0031
H	15.500	-	15.900	0.6102	-	0.6260
h	-	-	1.100	-	-	0.0433
L	0.800	-	1.100	0.0315	-	0.0433
N	-	-	10°	-	-	10°
s	-	-	8°	-	-	8°

OUTLINE AND MECHANICAL DAT A



PowerSO36 (SLUG UP)

- (1) "D and E1" do not include mold flash or protrusions. Mold flash or protrusions shall not exceed 0.15mm (0.006").
- (2) No intrusion allowed inwards the leads.





## 13 Revision history

**Table 13. Document revision history**

Date	Revision	Changes
18-Jan-2013	1	Initial release.
25-Jan-2013	2	Updated <i>Chapter 8.2: High efficiency introduction on page 28</i> .
18-Sep-2013	3	Updated Disclaimer.
10-Feb-2014	4	Updated <i>Table 5: Electrical characteristics</i> and <i>Section 9.1: I<sup>2</sup>C programming/reading sequences</i> .
10-Mar-2014	5	Updated <i>Figure 2, Figure 3</i> and <i>Table 5: Electrical characteristics</i> ( $\Delta V_{\text{OITU}}$ parameter on page 12).
28-Apr-2014	6	Updated <i>Section 9.2: Address selection and I<sup>2</sup>C disable on page 29</i> .
18-Sep-2014	7	Updated <i>Section 9.1: I<sup>2</sup>C programming/reading sequences on page 29</i> .
15-Dec-2014	8	Corrected <i>Figure 31 on page 22</i> .

**IMPORTANT NOTICE – PLEASE READ CAREFULLY**

STMicroelectronics NV and its subsidiaries ("ST") reserve the right to make changes, corrections, enhancements, modifications, and improvements to ST products and/or to this document at any time without notice. Purchasers should obtain the latest relevant information on ST products before placing orders. ST products are sold pursuant to ST's terms and conditions of sale in place at the time of order acknowledgement.

Purchasers are solely responsible for the choice, selection, and use of ST products and ST assumes no liability for application assistance or the design of Purchasers' products.

No license, express or implied, to any intellectual property right is granted by ST herein.

Resale of ST products with provisions different from the information set forth herein shall void any warranty granted by ST for such product.

ST and the ST logo are trademarks of ST. All other product or service names are the property of their respective owners.

Information in this document supersedes and replaces information previously supplied in any prior versions of this document.

© 2014 STMicroelectronics – All rights reserved