

CGA3E2X7R1C224K080AA

TDK Item Description : CGA3E2X7R1C224KT****



Equivalent C1608X7R1C224K for Automotive

Application & Main Feature

Automotive Grade (General (Up to 50V))

Series

CGA3(1608) [EIA CC0603]

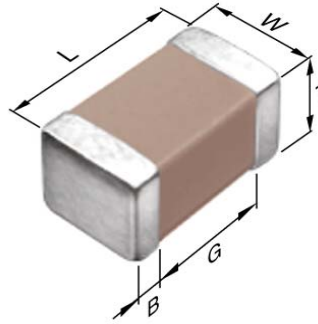

Dimensions

L 1.60mm +/-0.1mm
 W 0.80mm +/-0.1mm
 T 0.80mm +/-0.1mm
 B 0.20mm Min.
 G 0.30mm Min.

Temperature Characteristic

X7R (-55 to 125 degC +/-15%)

Rated Voltage

1C (16Vdc)

Capacitance

220nF

Capacitance Tolerance

K (+/-10%)

Dissipation Factor

5% Max.

Insulation Resistance

454Mohm Min.

AEC-Q200

Yes

DC Bias Characteristic

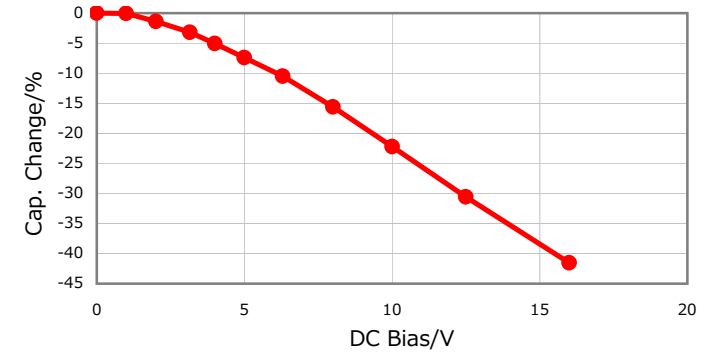

|Z|, ESR vs. Freq. Characteristics

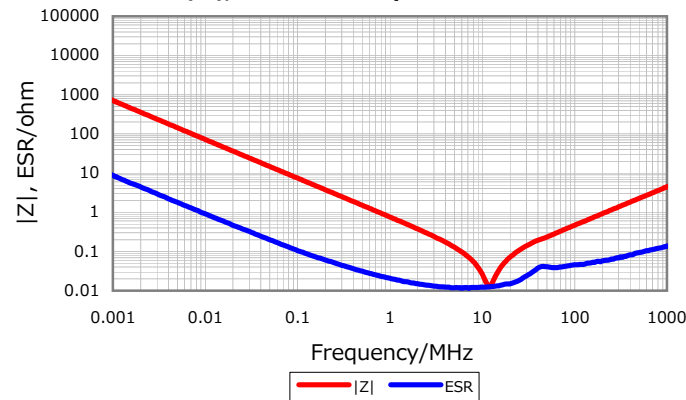

Temperature Characteristics

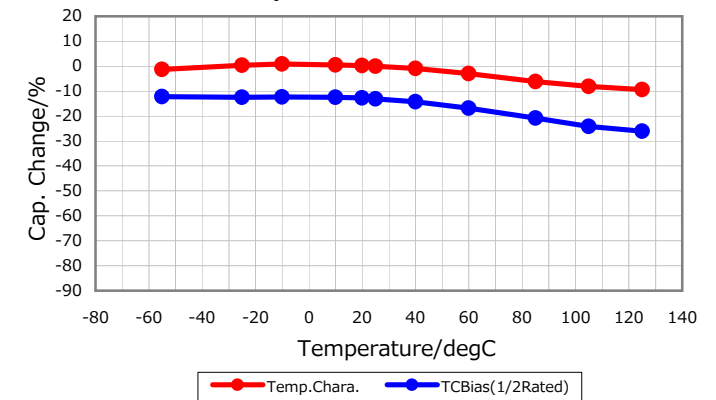

Cap. vs. Freq. Characteristic

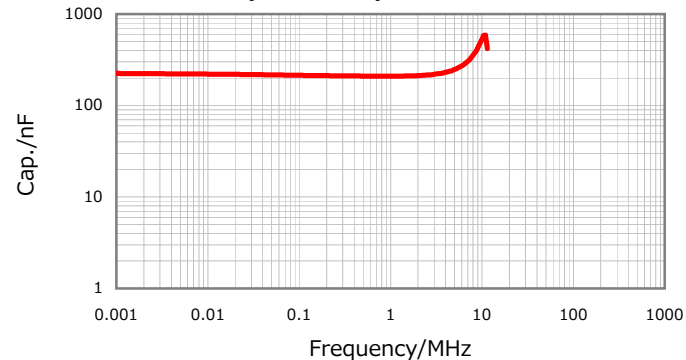

Ripple Temperature Rise Characteristics

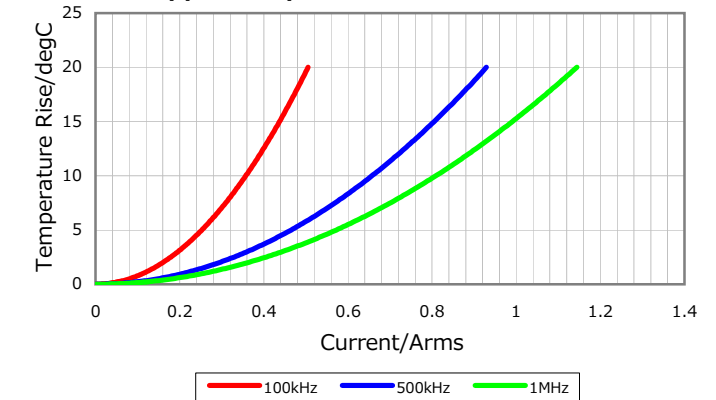

Characterization Sheet (Multilayer Ceramic Chip Capacitors)



All specifications are subject to change without notice.

January 4, 2016