

MSWSE-044-10

Silicon PIN Diode Switch Element

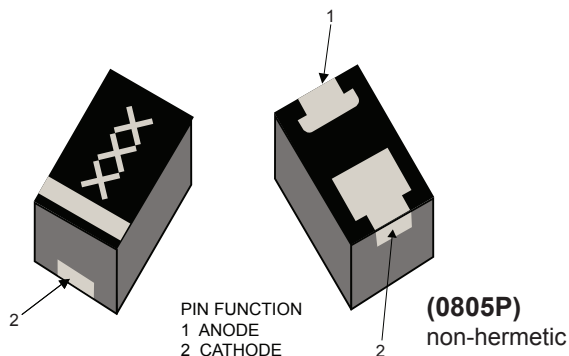

Description

The MSWSE-044-010 is a PIN diode SPST switch element designed for medium incident power applications, up to 40W C.W. It has low insertion loss and medium isolation below 2.0 GHz.

Features

- Broadband performance up to 2.0 GHz
- Cost effective choice for switch applications

Maximum Ratings

RATING	LIMITS	UNITS
V_R	300	V
I_F	200	mA
θ_{JC}	20	°C / W
T_J	+175	°C
T_{STG}	-55 to +150	°C
T_{SOLDER}	+260 °C per JEDEC STD-J-20C	

Electrical Characteristics, $T_c = +25\text{ °C}$

SYMBOL	TEST CONDITIONS		MIN	TYPICAL	MAX	UNITS
V_{BR}	$I_R = 10\ \mu\text{A}$		300	–	–	V
V_F	$I_F = 50\ \text{mA}$		–	900	1000	mV
C_T	$V_R = 10\ \text{V}$	$F = 1\ \text{MHz}$	–	0.30	0.40	pF
R_S	$I_F = 100\ \text{mA}$	$F = 500\ \text{MHz}$	–	0.5	0.70	Ω
τ	$I_F = 10\ \text{mA}$	$I_R = 6\ \text{mA}$ measured at 50%	–	1200	–	ns
W	I - Layer		–	40	–	μm
I_L	$I_F = 10\ \text{mA}$	$F < 1.0\ \text{GHz}$	–	0.20	0.30	dB
		$F < 2.0\ \text{GHz}$	–	0.25	0.35	dB
I_{50}	$V_R = 50\ \text{V}$	$F < 1.0\ \text{GHz}$	11	14	–	dB
		$F < 2.0\ \text{GHz}$	–	10	–	dB



Insertion Loss

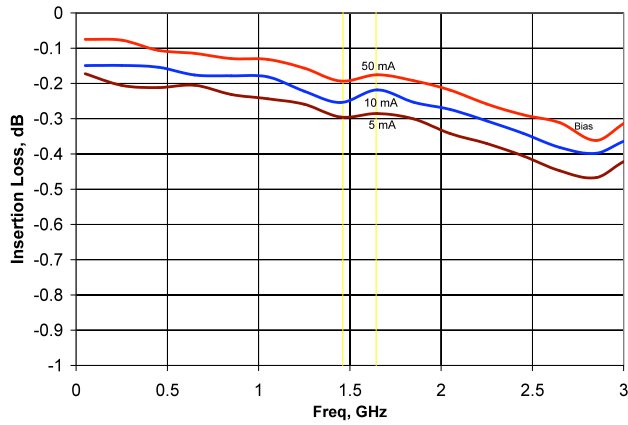

Isolation

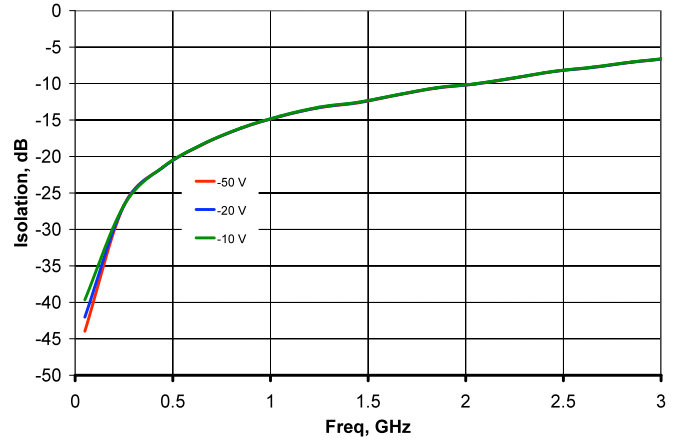

Input Return Loss

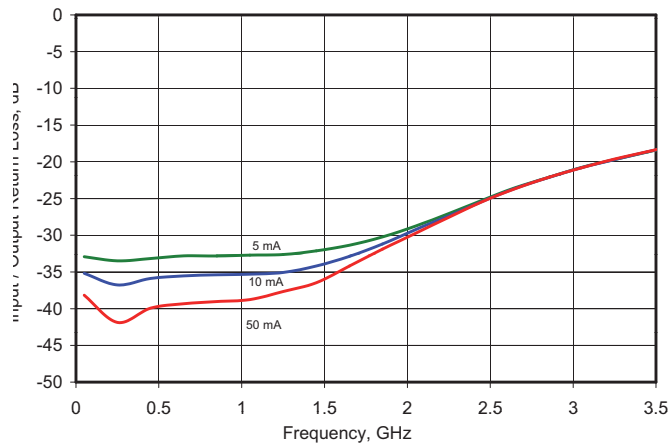

Series Resistance vs. Current

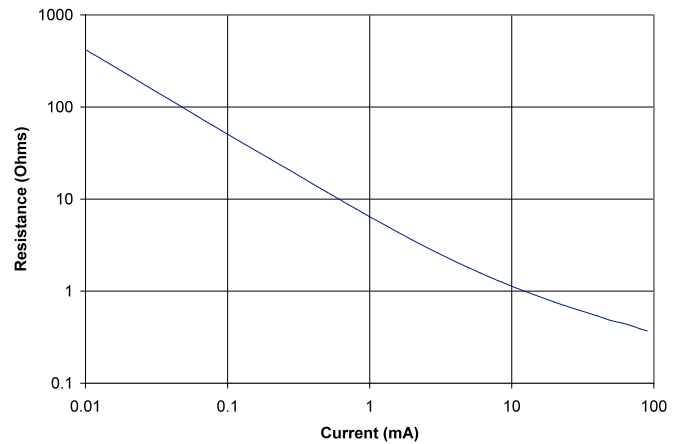

Package Outline

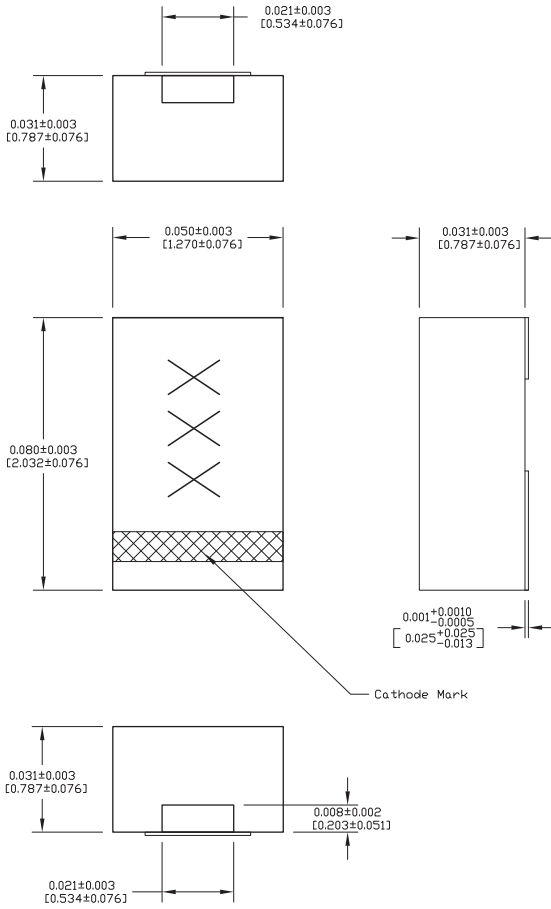

DFN 0805P PACKAGE

Pin function for Silicon PIN diode.
1. Anode
2. Cathode

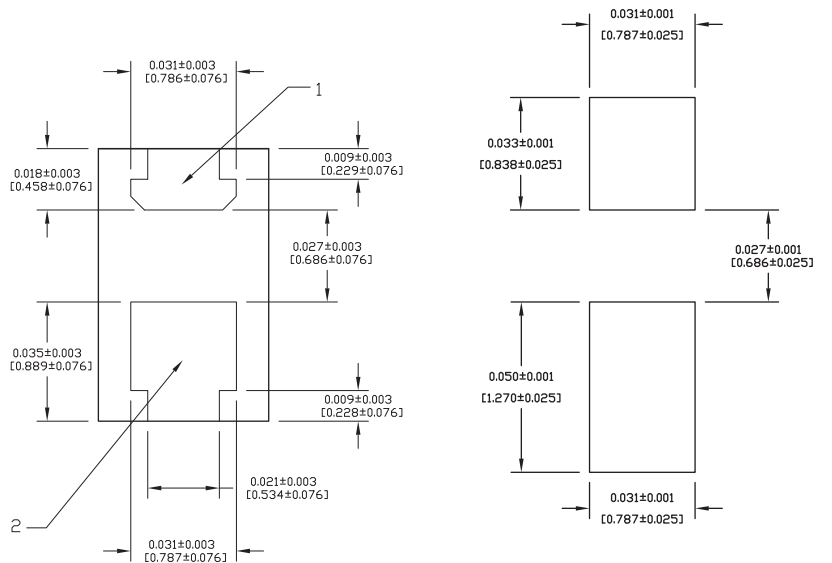

SOLDERING FOOTPRINT

Schematic

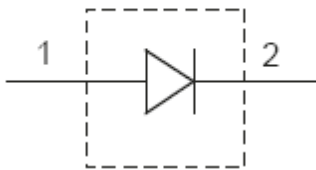

Aeroflex / Metelics Inc.

Aeroflex Microelectronic Solutions
975 Stewart Drive
Sunnyvale, CA 94085
TEL: 408-737-8181

54 Grenier Field Road
Londonderry, NH 03053
TEL: 603-641-3800

Sales

888-641-SEMI (7364)
metelics-sales@aeroflex.com

www.aeroflex.com/Microwave www.aeroflex.com/Metelics

Aeroflex / Metelics, Inc. reserves the right to make changes to any products and services herein at any time without notice. Consult Aeroflex or an authorized sales representative to verify that the information in this data sheet is current before using this product. Aeroflex does not assume any responsibility or liability arising out of the application or use of any product or service described herein, except as expressly agreed to in writing by Aeroflex; nor does the purchase, lease, or use of a product or service from Aeroflex convey a license under any patent rights, copyrights, trademark rights, or any other of the intellectual rights of Aeroflex or of third parties.

Copyright 2010 Aeroflex / Metelics. All rights reserved.

ISO 9001: 2008 certified companies



Our passion for performance is defined by three attributes represented by these three icons: solution-minded, performance-driven and customer-focused.