

4

3

2

1

THIS DRAWING IS UNPUBLISHED. RELEASED FOR PUBLICATION 2009
 © COPYRIGHT 2009 BY TYCO ELECTRONICS CORPORATION. ALL RIGHTS RESERVED.

LOC		DIST		REVISIONS			
P	LTR	DESCRIPTION		DATE	DWN	APVD	
	BA	NEW RELEASE		30-SEP-09	MRS	St.P	

FOR FURTHER INFORMATION SEE DATA SHEET FOR
 SERIES LR, METAL FILM FIXED RESISTORS

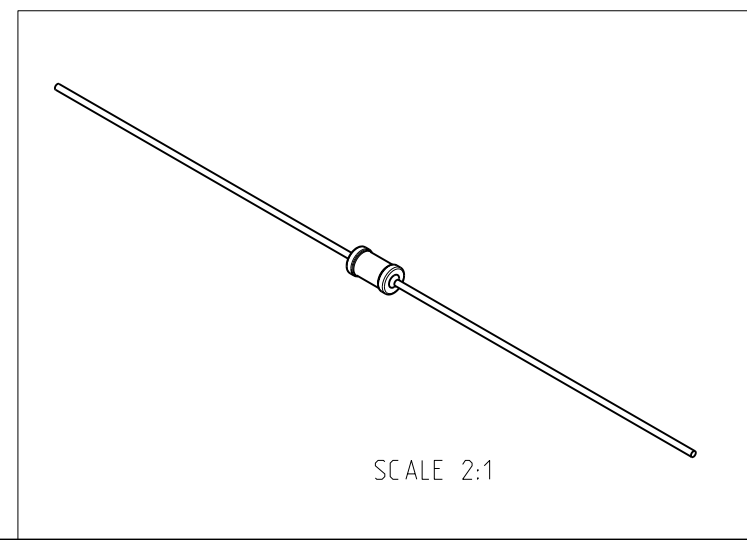
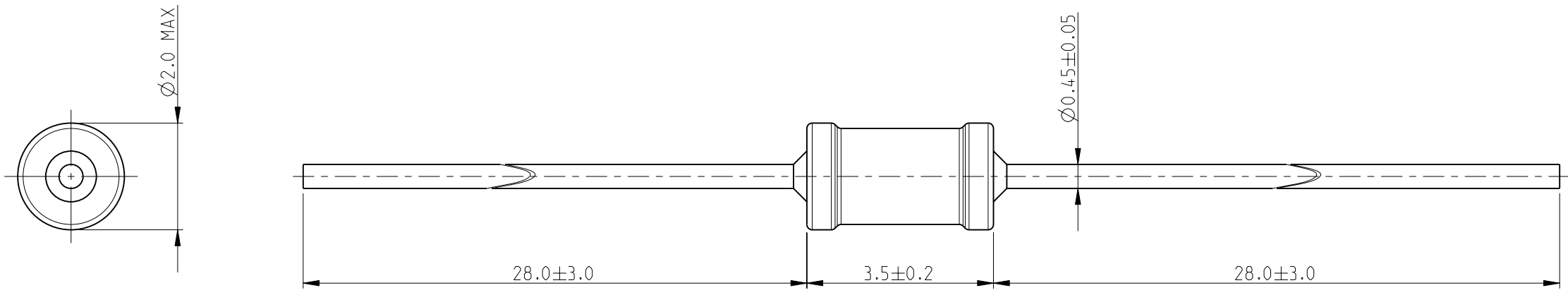

RoHS Compliant

<small>THIS DRAWING IS A CONTROLLED DOCUMENT FOR TYCO ELECTRONICS CORPORATION IT IS SUBJECT TO CHANGE AND THE CONTROLLING ENGINEERING ORGANIZATION SHOULD BE CONTACTED FOR THE LATEST REVISION.</small>		DWN MAHARUDRA 30-SEP-09 CHK ALLAN.P 30-SEP-09 APVD STEPHEN.P 30-SEP-09		Tyco Electronics Corporation Dorcan, Swindon, SN3 5HH	
DIMENSIONS: mm		TOLERANCES UNLESS OTHERWISE SPECIFIED: 0 PLC ± 0.2 1 PLC ± 0.1 2 PLC ± - 3 PLC ± - 4 PLC ± - ANGLES ± 5°		NAME METAL FILM FIXED RESISTORS SERIES LR0204	
MATERIAL -		FINISH -		PRODUCT SPEC - APPLICATION SPEC - WEIGHT -	
CUSTOMER DRAWING				SIZE A3 CAGE CODE 00779 DRAWING NO C-1622194	RESTRICTED TO -
				SCALE 10:1	SHEET 1 OF 1
				REV BA	