

0.28" Seven-Segment Numeric LED Display

LTS-2X01A

LTD-2000 Series

LTC-2000

Features

- 0.28 inch (7.0mm) digit height
- Choices of five bright colors-AlGaAs red/bright red/green/yellow/red orange.
- Low power requirement.
- Excellent characters appearance.
- Categorized for luminous intensity.
- I.C. compatible.
- Easy mounting on P.C. board or socket.

Descriptions

The LTS-2X01A, LTD-2000, LTC-2000 series are 0.28 inch (7.0mm) height single, dual triple and quadruple digit displays.

The AlGaAs red seven segment displays are designed for applications requiring low power consumption. They are tested and selected for the excellent low current characteristics to ensure that the segments are matched at low current. Drive current as low as 1 mA per segment is available.

The AlGaAs red series devices utilize LED chips which are made from AlGaAs on a non-transparent GaAs substrate. The bright red and green series devices utilize LED chips which are made from GaP on a transparent GaP substrate. The yellow and red orange series devices utilize LED chips which are made from GaAsP on a transparent GaP substrate. All devices have gray face and white segments.

Devices

Part No.					Description	Package Dimension	Internal Circuit Diagram
AlGaAs Red	Bright Red	Green	Yellow	Red Orange			
LTS-2301AWC	2301AP	2301AG	2301AY	2301AE	Common Cathode, Rt. Hand Decimal	A	A
LTS-2801AWC	2801AP	2801AG	2801AY	2801AE	Common Anode, Rt. Hand Decimal	A	B
LTD-2601WC	2601P	2601G	2601Y	2601E	Duplex Common Anode, Rt. Hand Decimal	B	C
LTD-2701WC	2701P	2701G	2701Y	2701E	Duplex Common Cathode, Rt. Hand Decimal	B	D
LTC-2621WC	2621P	2621G	2621Y	2621E	Multiplex Common Anode, Rt. Hand Decimal	C	E
LTC-2721WC	2721P	2721G	2721Y	2721E	Multiplex Common Cathode, Rt. Hand Decimal	C	F
LTC-2623WC	2623P	2623G	2623Y	2623E	Multiplex Common Anode, Rt. Hand Decimal	D	G
LTC-2723WC	2723P	2723G	2723Y	2723E	Multiplex Common Cathode, Rt. Hand Decimal	D	H

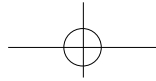

Package Dimensions

A.LTS-2301A/2801A

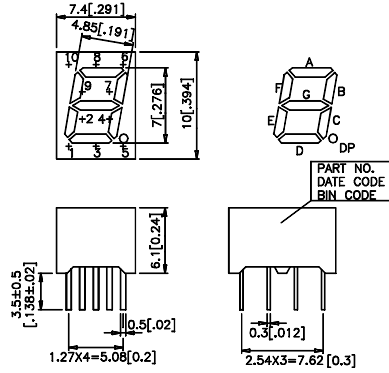

B.LTD-2601/2701

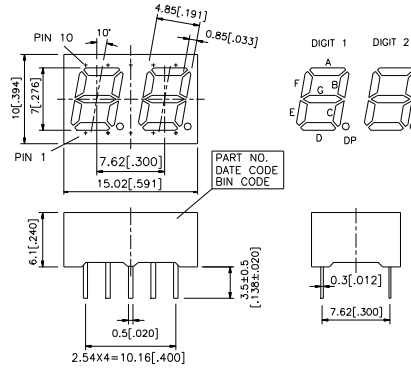

C.LTC-2621/2721

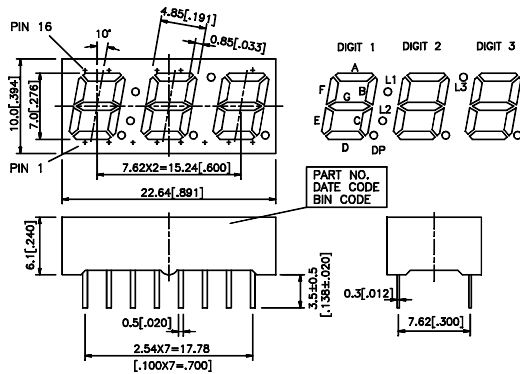

D.LTC-2623/2723

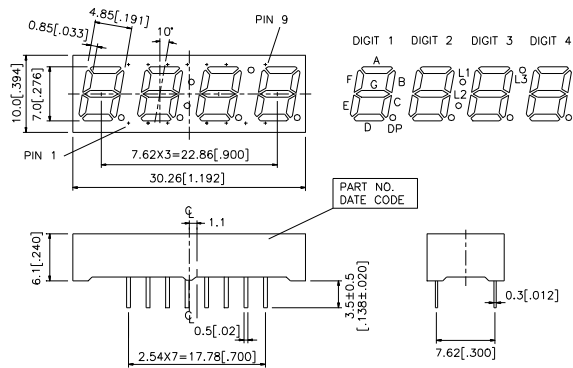

DISPLAYS

Notes: All dimensions are in millimeters (inches). Tolerance: ± 0.25mm (0.01") unless otherwise noted.

Pin Connection

Pin No.	Connection	
	A.LTS-2301A	B.LTS-2801A
1.	Anode E	Cathode E
2.	Anode D	Cathode D
3.	Common Cathode	Common Anode
4.	Anode C	Cathode C
5.	Anode D.P.	Cathode D.P.
6.	Anode B	Cathode B
7.	Anode A	Cathode A
8.	Common Cathode	Common Anode
9.	Anode G	Cathode G
10.	Anode F	Cathode F

Pin No.	Connection	
	C.LTD-2601	D.LTD-2701
1.	Cathode E	Anode E
2.	Cathode D	Anode D
3.	Cathode C	Anode C
4.	Cathode G	Anode G
5.	Cathode D.P.	Anode D.P.
6.	Common Anode Digit 2	Common Cathode Digit 2
7.	Cathode A	Anode A
8.	Cathode B	Anode B
9.	Common Anode Digit 1	Common Cathode Digit 1
10.	Cathode F	Anode F

9-115

Pin No.	Connection	
	E.LTC-2621	F.LTC-2721
1.	Cathode D	Anode D
2.	Common Anode Digit 1	Common Cathode Digit 1
3.	Cathode D.P.	Anode D.P.
4.	Cathode E	Anode E
5.	Common Anode Digit 2	Common Cathode Digit 2
6.	Cathode C	Anode C
7.	Cathode G	Anode G
8.	Common Anode Digit 3	Common Cathode Digit 3
9.	No Connection	No Connection
10.	No Pin	No Pin
11.	No Pin	No Pin
12.	Cathode B	Anode B
13.	Common Anode L1, L2, L3	Common Cathode L1, L2, L3
14.	No Pin	No Pin
15.	Cathode A	Anode A
16.	Cathode F	Anode F

Pin No.	Connection	
	G.LTC-2623	H.LTC-2723
1.	Common Anode Digit 1	Common Cathode Digit 1
2.	Cathode C, L3	Anode C, L3
3.	Cathode D.P.	Anode D.P.
4.	No Connection	No Connection
5.	Cathode E	Anode E
6.	Cathode D	Anode D
7.	Cathode G	Anode G
8.	Common Anode Digit 4	Common Cathode Digit 4
9.	No Connection	No Connection
10.	No Pin	No Pin
11.	Common Anode Digit 3	Common Cathode Digit 3
12.	Common Anode L1, L2, L3	Common Cathode L1, L2, L3
13.	Cathode A, L1	Anode A, L1
14.	Common Anode Digit 2	Common Cathode Digit 2
15.	Cathode B, L2	Anode B, L2
16.	Cathode F	Anode F

Internal Circuit Diagrams

A.LTS-2301A

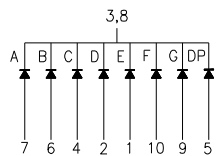

B.LTS-2801A

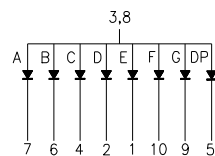

C.LTD-2601

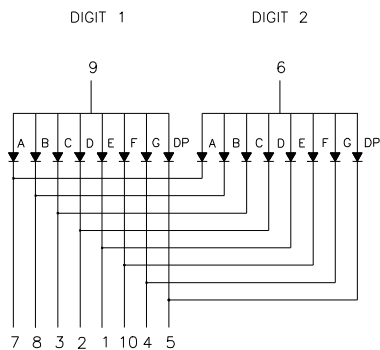

D.LTD-2701

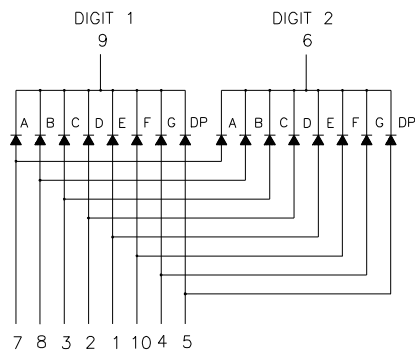

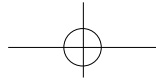

E.LTC-2621

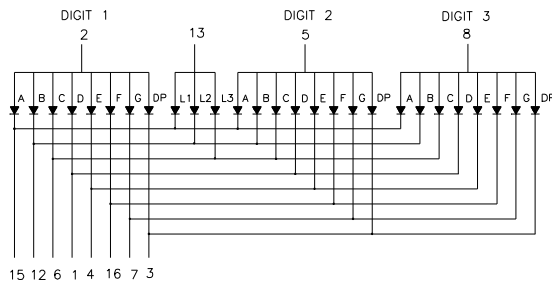

F.LTC-2721

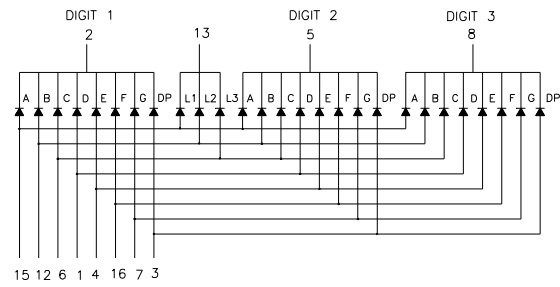

G.LTC-2623

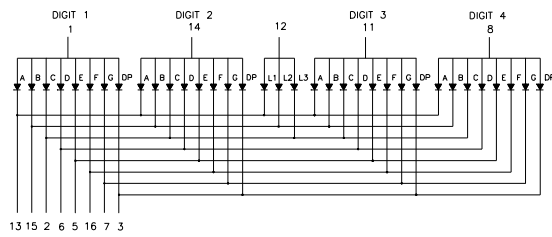

H.LTC-2723

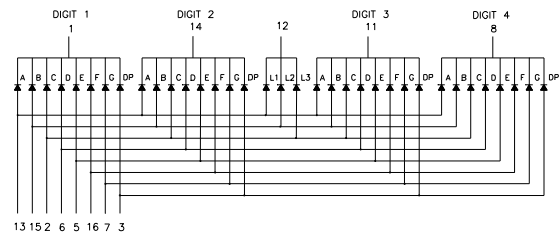

DISPLAYS

Absolute Maximum Rating at Ta=25°C

Parameter	AlGaAs Red	Bright Red	Green	Yellow	Red Orange	Unit
Power Dissipation Per Segment	75	40	75	60	75	mW
Peak Forward Current Per Segment (1/10 Duty Cycle, 0.1ms Pulse Width)	125	60	100	80	100	mA
Continuous Forward Current Per Segment	30	15	25	20	25	mA
Derating Linear from 25°C Per Segment	0.4	0.2	0.33	0.27	0.33	mA/°C
Reverse Voltage Per Segment	5	5	5	5	5	V
Operating Temperature Range	-35°C to +85°C					
Storage Temperature Range	-35°C to +85°C					
Solder Temperature 1/16 Inch Below Seating Plane for 3 Seconds at 260°C						

Electrical/Optical Characteristics at Ta=25°C

LTC-2621WC/2721WC/2623WC/2723WC

Parameter	Symbol	Min.	Typ.	Max.	Unit	Tset Condition
Average Luminous Intensity	I _v	200	600		μ cd	I _F =1mA
			3100			I _F =5mA
Peak Emission Wavelength	λ _P		660		nm	I _F =20mA
Spectral Line Half-Width	Δλ		35		nm	I _F =20mA
Dominant Wavelength	λ _d		638		nm	I _F =20mA
Forward Voltage, Per Segment	V _F		1.6	2.4	V	I _F =1mA
			1.7			I _F =5mA
			1.8			I _F =20mA
Reverse Current, Per Segment	I _R			100	μ A	V _R =5V
Luminous Intensity Matching Ratio	I _v -m			2:1		I _F =1mA

9-117

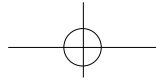

LTS-2301AP/2801AP/LTD-2601P/2701P/LTC-2621P/2721P/2623P/2723P

Parameter	Symbol	Min.	Typ.	Max.	Unit	Tset Condition
Average Luminous Intensity	I _v	320	750		μ cd	I _F =10mA
Peak Emission Wavelength	λ P		697		nm	I _F =20mA
Spectral Line Half-Width	Δ λ		90		nm	I _F =20mA
Dominant Wavelength	λ d		657		nm	I _F =20mA
Forward Voltage, Per Segment or D.P.	V _F		2.1	2.6	V	I _F =20mA
Reverse Current, Per Segment or D.P.	I _R			100	μ A	V _R =5V
Luminous Intensity Matching Ratio	I _v -m			2:1		I _F =10mA

LTS-2301AG/2801AG/LTD-2601G/2701G/LTC-2621G/2721G/2623G/2723G

Parameter	Symbol	Min.	Typ.	Max.	Unit	Tset Condition
Average Luminous Intensity	I _v	800	2000		μ cd	I _F =10mA
Peak Emission Wavelength	λ P		565		nm	I _F =20mA
Spectral Line Half-Width	Δ λ		30		nm	I _F =20mA
Dominant Wavelength	λ d		569		nm	I _F =20mA
Forward Voltage, Per Segment	V _F		2.1	2.6	V	I _F =20mA
Reverse Current, Per Segment	I _R			100	μ A	V _R =5V
Luminous Intensity Matching Ratio	I _v -m			2:1		I _F =10mA

LTS-2301AY/2801AY/LTD-2601Y/2701Y/LTC-2621Y/2721Y/2623Y/2723Y

Parameter	Symbol	Min.	Typ.	Max.	Unit	Tset Condition
Average Luminous Intensity	I _v	800	2000		μ cd	I _F =10mA
Peak Emission Wavelength	λ P		585		nm	I _F =20mA
Spectral Line Half-Width	Δ λ		35		nm	I _F =20mA
Dominant Wavelength	λ d		588		nm	I _F =20mA
Forward Voltage, Per Segment	V _F		2.1	2.6	V	I _F =20mA
Reverse Current, Per Segment	I _R			100	μ A	V _R =5V
Luminous Intensity Matching Ratio	I _v -m			2:1		I _F =10mA

LTS-2301AE/2801AE/LTD-2601E/2701E/LTC-2621E/2721E/2623E/2723E

Parameter	Symbol	Min.	Typ.	Max.	Unit	Tset Condition
Average Luminous Intensity	I _v	800	2000		μ cd	I _F =10mA
Peak Emission Wavelength	λ P		630		nm	I _F =20mA
Spectral Line Half-Width	Δ λ		40		nm	I _F =20mA
Dominant Wavelength	λ d		621		nm	I _F =20mA
Forward Voltage, Per Segment	V _F		2.0	2.6	V	I _F =20mA
Reverse Current, Per Segment	I _R			100	μ A	V _R =5V
Luminous Intensity Matching Ratio	I _v -m			2:1		I _F =10mA

Notes: Luminous intensity is measured with a light sensor and filter combination that approximates the CIE (Commission Internationale De L' Eclairage) eye-response curve.

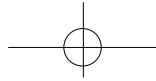

Typical Electrical/Optical Characteristic Curves (25°C Ambient Temperature Unless Otherwise Noted)

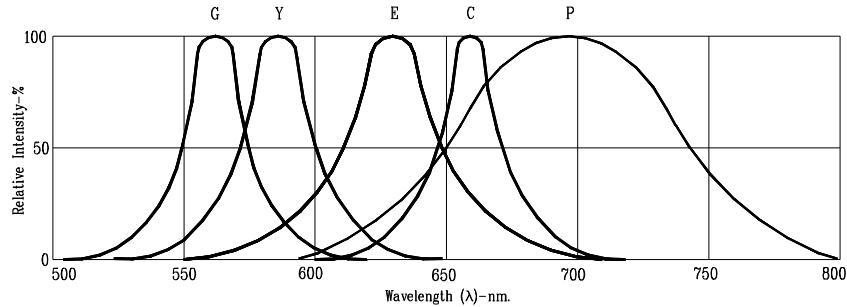

Fig1. RELATIVE INTENSITY VS. WAVELENGTH

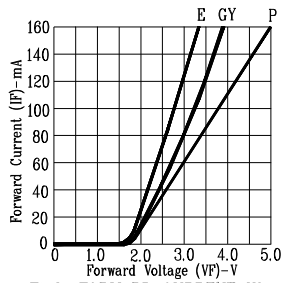

Fig2. FORWARD CURRENT VS. FORWARD VOLTAGE

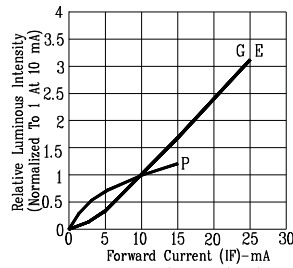

Fig3. RELATIVE LUMINOUS INTENSITY VS. FORWARD CURRENT

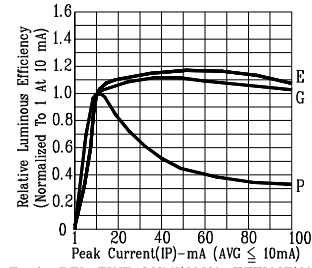

Fig4. RELATIVE LUMINOUS EFFICIENCY (LUMINOUS INTENSITY PER UNIT CURRENT) VS. PEAK CURRENT

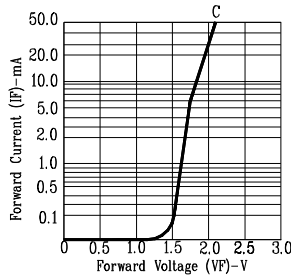

Fig5. FORWARD CURRENT VS. FORWARD VOLTAGE

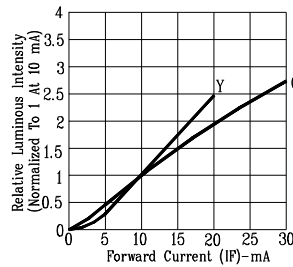

Fig6. RELATIVE LUMINOUS INTENSITY VS. FORWARD CURRENT

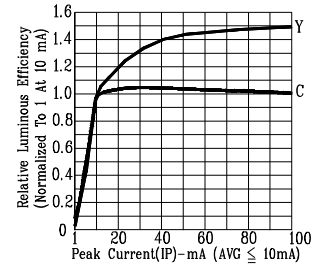

Fig7. RELATIVE LUMINOUS EFFICIENCY (LUMINOUS INTENSITY PER UNIT CURRENT) VS. PEAK CURRENT

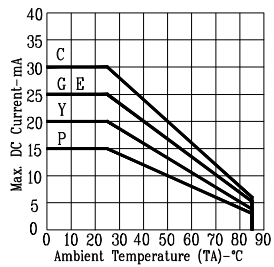

Fig8. MAX. ALLOWABLE DC CURRENT VS. AMBIENT TEMPERATURE.

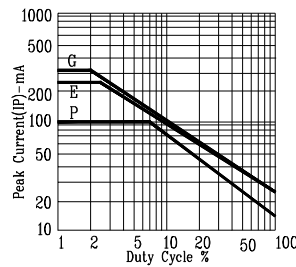

Fig9. MAX. PEAK CURRENT VS. DUTY CYCLE % (REFRESH RATE 1KHz)

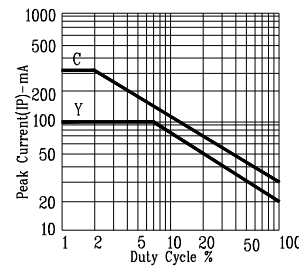

Fig10. MAX. PEAK CURRENT VS. DUTY CYCLE % (REFRESH RATE 1KHz)

NOTE: P=BRIGHT RED E=RED ORANGE G=GREEN Y=YELLOW C=AlGaAs RED (REFRESH RATE 1KHz)

DISPLAYS