

GlobTek, Inc. www.globtek.com 186 Veterans Drive, Northvale, NJ 07647 Tel. (201) 784-1000 Fax (201) 784-0111	Drawing Title: GT-46240-2412-T2, ITE Power Supply, Efficiency Level: VI, Case Color/Style: GlobTek Black, Desktop/External, Regulated Switchmode AC-DC Power Supply AC Adaptor, Input Rating: 100-240V~, 50-60 Hz, IEC 60320/C8, Output Rating: 24W, 12V@2A, Output Configuration: 1530 mm, 18/2 Cond, UL 2468, Female Barrel 5.5*2.1*11mm WITH internal Spring Clip and Locking Notch or Equal, Ferrite: Core Size: 14.2*28.5*8.2, GlobTek Black, GT Cord # C5225, Pin Out: Center Positive (+V), Blades/Input Cord: Not Applicable, Approvals: EAC Level VI WEEE cUL 230V CoC Tier 2 CE China RoHS IP42 LPS PSE RoHS Ukraine VCCI Double Insulation S-Mark CB RCM	
	Model No. GT-46240-2412-T2	
	Part No./Ordering No. TR9KE2000CCP-N(R6B)	Rev C1

## REVISION HISTORY

REV	DESCRIPTION	SUB	DATE	APPROVED
C1	Revised packaging: change from egg crate to gift box.	rchiu	10/31/2017	QA
C	Update packaging Update output cord	rchiu	09/19/2017	QA
B	Change core size from 12*20*7.3 mm to 14.2*28.5*8.2 mm, change O/P cord tolerance from 1500+80,-0 to 1500+150,-0 mm	QA	09/11/2017	QA
A1	Update approval: remove CCC warning words 'non-tropic'	QA	09/05/2017	QA
A	Initial release.	emcna	09/22/2016	QA

In Addition to GlobTek Inc.'s renewed ISO9001:2008 - Quality Management System Certification, GlobTek Inc. is now certified to:

ISO13485:2003 - Medical Devices Quality Management System Certification  
 ISO14001:2004 - Environmental Management System Certification

ISO Certificates are available online at <http://www.globtek.com/iso-certificates/>

### Customer Approval of Specification:

Please approve, sign and send back to GlobTek so we can complete order processing.

A delay in receipt of this form will delay delivery schedule.

Company Name:

Customer P/N:

Quote Number:

Date:

Authorized Representative Name:

Authorized Representative Signature:

The acceptance of this specification and use of the product described in this document indicates the acceptance and binding of the customer to Globtek terms and conditions, which supersede all other agreements, terms, and conditions (<http://en.globtek.com/terms-and-conditions/>).

### Footnote:

GlobTek Inc. will not be liable for the safety and performance of these power supplies if unauthorized access and repair occurs. End user should consult applicable UL, CSA or EN standards for proper installation instruction.

### Limitation of Use:

GlobTek product are not authorized for use as mission critical components in life support hazardous environment, nuclear or aircraft applications without prior written approval from the CEO of GlobTek Inc.

Contents of this document are subject to change without prior notice.

GT-46240-2412-T2, 24W, 12V@2A, Desktop/External, Regulated Switchmode AC-DC Power Supply AC Adaptor

PROPRIETARY INFORMATION

PROPRIETARY OF GLOBTEK, INC. ANY REPRODUCTION, DISCLOSURE OR USE OF THIS DRAWING, IN WHOLE OR IN PART, IS HEREBY PROHIBITED EXCEPT AS SPECIFIED IN WRITING BY GLOBTEK, INC.

GlobTek, Inc. www.globtek.com 186 Veterans Drive, Northvale, NJ 07647 Tel. (201) 784-1000 Fax (201) 784-0111	Drawing Title: GT-46240-2412-T2, ITE Power Supply, Efficiency Level: VI, Case Color/Style: GlobTek Black, Desktop/External, Regulated Switchmode AC-DC Power Supply AC Adaptor, Input Rating: 100-240V~, 50-60 Hz, IEC 60320/C8 , Output Rating: 24W, 12V@2A, Output Configuration: 1530 mm, 18/2 Cond, UL 2468, Female Barrel 5.5*2.1*11mm WITH internal Spring Clip and Locking Notch or Equal, Ferrite: Core Size: 14.2*28.5*8.2, GlobTek Black, GT Cord # C5225, Pin Out: Center Positive (+V), Blades/Input Cord: Not Applicable, Approvals: EAC Level VI WEEE cUL 230V CoC Tier 2 CE China RoHS IP42 LPS PSE RoHS Ukraine VCCI Double Insulation S-Mark CB RCM	
	Model No. GT-46240-2412-T2	
	Part No./Ordering No. TR9KE2000CCP-N(R6B)	Rev C1

## POWER SUPPLY INFORMATION

TYPE: Desktop/External  
TECHNOLOGY: Regulated Switchmode AC-DC Power Supply AC Adaptor  
CASE COLOR: GlobTek Black  
NAMEPLATE RATED INPUT: 100-240V~, 50-60 Hz, 0.6 A  
INPUT CONFIG: IEC 60320/C8  
WATTS: 24.0  
VOLTS OUT: 12  
CURRENT OUT (Amps): 2  
BLADE/CORD INCLUDED: N/A:  
BLADE/CORD INSTALLED: N/A:  
GROUNDING CONFIGURATION (F1) Class II / Double Insulated  
EFFICIENCY LEVEL: VI  
OUTPUT CONFIGURATION 1530 mm, 18/2 Cond, UL 2468, Female Barrel 5.5\*2.1\*11mm WITH internal Spring Clip and Locking Notch or Equal,  
CONNECTOR PIN OUT: Ferrite: Core Size: 14.2\*28.5\*8.2, GlobTek Black, GT Cord # C5225  
Center Positive (+V)  
LABEL SPECS: Standard GT,L-1186  
PACK SPEC: Standard DT, Individually Box

Notes/Modifications/Customizations (notes in this section supersede the values shown in the standard spec):

DIMENSIONS ARE IN MM UNLESS SPECIFIED OTHERWISE.

GlobTek, Inc. www.globtek.com 186 Veterans Drive, Northvale, NJ 07647 Tel. (201) 784-1000 Fax (201) 784-0111	Drawing Title: GT-46240-2412-T2, ITE Power Supply, Efficiency Level: VI, Case Color/Style: GlobTek Black, Desktop/External, Regulated Switchmode AC-DC Power Supply AC Adaptor, Input Rating: 100-240V~, 50-60 Hz, IEC 60320/C8 , Output Rating: 24W, 12V@2A, Output Configuration: 1530 mm, 18/2 Cond, UL 2468, Female Barrel 5.5*2.1*11mm WITH internal Spring Clip and Locking Notch or Equal, Ferrite: Core Size: 14.2*28.5*8.2, GlobTek Black, GT Cord # C5225, Pin Out: Center Positive (+V), Blades/Input Cord: Not Applicable, Approvals: EAC Level VI WEEE cUL 230V CoC Tier 2 CE China RoHS IP42 LPS PSE RoHS Ukraine VCCI Double Insulation S-Mark CB RCM	
	Model No. GT-46240-2412-T2	
	Part No./Ordering No. TR9KE2000CCP-N(R6B)	Rev C1

## ELECTRICAL SPECIFICATIONS

### A) ELECTRICAL SPECIFICATIONS:

01. Input Voltage: Specified 90-264 Vac, Nameplate rated: 100-240Vac
02. Input Frequency: Specified 47-63 Hz, Nameplate rated 50-60Hz
03. Inrush Current: 50A Max. at 115VAC cold start, 100A Max. at 230VAC cold start
04. Average Efficiency: 86.2% Min (CEC & DOE LEVEL VI Compliant); 86.8% Min (ErP **European** Commission's Ecodesign Directive (2005/32/EC) / CoC Tier 2 Compliant)
05. Input Power(no load): <0.1W (CEC & DOE Level VI Compliant); <0.075W ErP **European** Commission's Ecodesign Directive (2005/32/EC) / CoC Tier 2 Compliant)
06. Output Voltage tolerance:  $\pm 5\%$
07. Load regulation:  $\pm 5\%$
08. Output Voltage: Tolerance  $\pm 5\%$
09. Turn On Delay: 3000 mS MAX at 115 VAC Full Load
10. Hold Up Time: 10 mS Min at 100 VAC Full Load
11. Ripple and Noise (Vp-p): 100 mVp-p maximum, At 20 MHz, and output parallel with 0.1uF & 47uF capacitors to ground. Temperature at 25 °C, and nominal input voltage

### B) PROTECTION

01. Over voltage protection: protection zener
02. Short circuit protection: Output shut down and auto- recover
03. Over Load Protection: Output shut down and auto restart

### C) SAFETY

01. HI-POT : Input to output : 1500VAC or 2121VDC 10mA 1 minute
02. Earth Leakage Current: <3.5 mA at 240Vac input voltage
03. Insulation resistance: Input to output: 500vdc to test the input to output resistance not be less 100M ohm
04. Earth continuity test:<0.1 Ohm or < 0.2 Ohm when with a non-detachable Power Supply cord, Class I Only

### D) OTHER:

01. MTBF: 200,000 Hours @ 25°C ambient temperature
02. Operating Temperature: 0°C to 40°C ambient temperature
03. Humidity Operating : 20% to 80%. 0% to 90% relative humidity
04. Storage Temperature: -10°C to 70°C  
Humidity Storage: 10% to 90%
05. RoHS 2: Complies with EU 2011/65/EU and China SJ/T 11364-2014

### E) ENCLOSURE

01. Housing: High impact plastic, 94V0 polycarbonate, non-vented
02. Size: 80.6\*50.0\*31.0 +/-1.0 mm
03. Markings: Label and/or Pad Printed and/or Molded in the case

#### PROPRIETARY INFORMATION

PROPRIETARY OF GLOBTEK, INC. ANY REPRODUCTION, DISCLOSURE OR USE OF THIS DRAWING, IN WHOLE OR IN PART, IS HEREBY PROHIBITED EXCEPT AS SPECIFIED IN WRITING BY GLOBTEK, INC.

quest /08/20/2018 7:42:41 AM

GlobTek, Inc.  
www.globtek.com  
186 Veterans Drive,  
Northvale, NJ 07647  
Tel. (201) 784-1000  
Fax (201) 784-0111

Drawing Title: GT-46240-2412-T2, ITE Power Supply, Efficiency Level: VI, Case Color/Style: GlobTek Black, Desktop/External, Regulated Switchmode AC-DC Power Supply AC Adaptor, Input Rating: 100-240V~, 50-60 Hz, IEC 60320/C8, Output Rating: 24W, 12V@2A, Output Configuration: 1530 mm, 18/2 Cond, UL 2468, Female Barrel 5.5\*2.1\*11mm WITH internal Spring Clip and Locking Notch or Equal, Ferrite: Core Size: 14.2\*28.5\*8.2, GlobTek Black, GT Cord # C5225, Pin Out: Center Positive (+V), Blades/Input Cord: Not Applicable, Approvals: EAC Level VI WEEE cUL 230V CoC Tier 2 CE China RoHS IP42 LPS PSE RoHS Ukraine VCCI Double Insulation S-Mark CB RCM

Model No. GT-46240-2412-T2

Part No./Ordering No. TR9KE2000CCP-N(R6B)

Rev C1

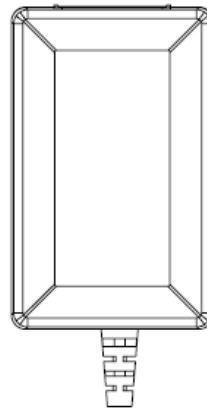
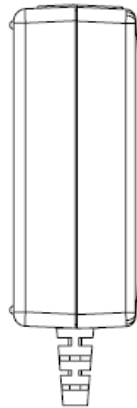
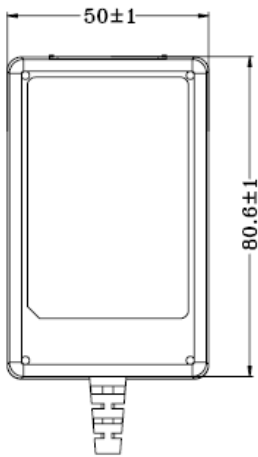
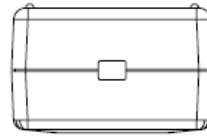
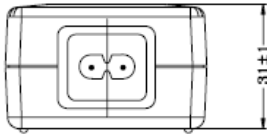

DERATING CURVE

GlobTek, Inc.  
 www.globtek.com  
 186 Veterans Drive,  
 Northvale, NJ 07647  
 Tel. (201) 784-1000  
 Fax (201) 784-0111

Drawing Title: GT-46240-2412-T2, ITE Power Supply, Efficiency Level: VI, Case Color/Style: GlobTek Black, Desktop/External, Regulated Switchmode AC-DC Power Supply AC Adaptor, Input Rating: 100-240V~, 50-60 Hz, IEC 60320/C8, Output Rating: 24W, 12V@2A, Output Configuration: 1530 mm, 18/2 Cond, UL 2468, Female Barrel 5.5\*2.1\*11mm WITH internal Spring Clip and Locking Notch or Equal, Ferrite: Core Size: 14.2\*28.5\*8.2, GlobTek Black, GT Cord # C5225, Pin Out: Center Positive (+V), Blades/Input Cord: Not Applicable, Approvals: EAC Level VI WEEE cUL 230V CoC Tier 2 CE China RoHS IP42 LPS PSE RoHS Ukraine VCCI Double Insulation S-Mark CB RCM

Model No. GT-46240-2412-T2

Part No./Ordering No. TR9KE2000CCP-N(R6B)

Rev C1

### Typical External Power Supply Derating Curve

(For Efficiency Level V and Efficiency Level VI Products)

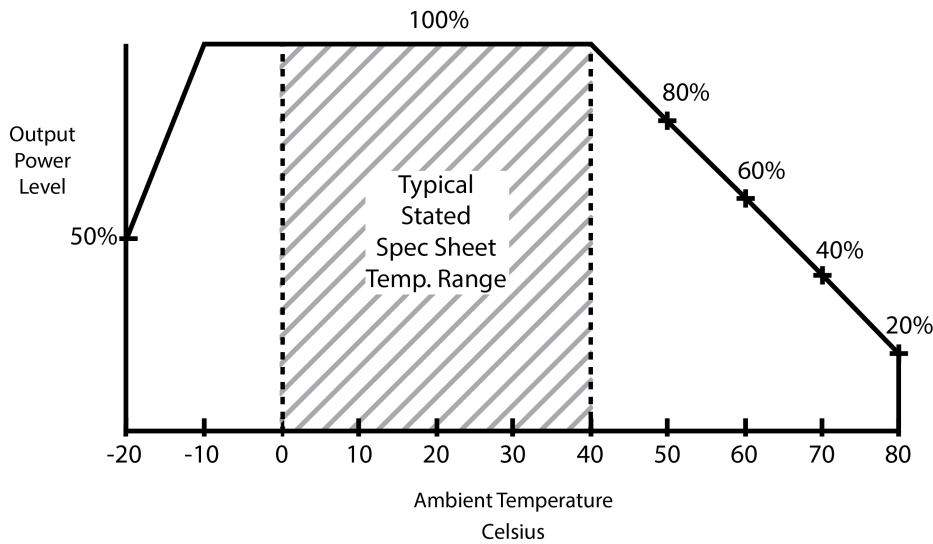

GlobTek, Inc. www.globtek.com 186 Veterans Drive, Northvale, NJ 07647 Tel. (201) 784-1000 Fax (201) 784-0111	Drawing Title: GT-46240-2412-T2, ITE Power Supply, Efficiency Level: VI, Case Color/Style: GlobTek Black, Desktop/External, Regulated Switchmode AC-DC Power Supply AC Adaptor, Input Rating: 100-240V~, 50-60 Hz, IEC 60320/C8 , Output Rating: 24W, 12V@2A, Output Configuration: 1530 mm, 18/2 Cond, UL 2468, Female Barrel 5.5*2.1*11mm WITH internal Spring Clip and Locking Notch or Equal, Ferrite: Core Size: 14.2*28.5*8.2, GlobTek Black, GT Cord # C5225, Pin Out: Center Positive (+V), Blades/Input Cord: Not Applicable, Approvals: EAC Level VI WEEE cUL 230V CoC Tier 2 CE China RoHS IP42 LPS PSE RoHS Ukraine VCCI Double Insulation S-Mark CB RCM	
	Model No. GT-46240-2412-T2	
	Part No./Ordering No. TR9KE2000CCP-N(R6B)	Rev C1

## INPUT CONFIGURATION

Grounding Configuration:

Blades/Cord Included: N/A:

Blades/Cord Installed: N/A:

IEC 60320/C8 AC Inlet connector, Class II, Non-Earth Ground (aka "Figure-8")

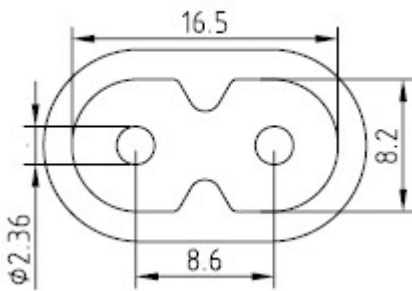

Mates with IEC 60320/C7 Plug

[Standard International IEC 320/C7 Cordsets](#)

Below are standard cordsets which are "not included" (unless stated above); these may be purchased separately or packaged with the power supply.

Please contact your Sales Engineer if the style required is not shown below. Many more available in different lengths, colors or cable material.

Conductors (No Ground) IEC 320/C7 (Figure "8")

Part No	Country	End A	End B	Length
<a href="#">4511116F703A(R)</a>	N. American	NEMA 1-15P	IEC 320/C7	1830
<a href="#">5014112M703A(R)</a>	Australian	AS 3112	IEC 320/C7	2000
<a href="#">4533501M8703(R)</a>	China	GB 2099.1	IEC 320/C7	1830
<a href="#">204B4222M703(R)</a>	Brazil	Brazil NBR 6147	IEC 320/C7	2000
<a href="#">2074112M703A(R)</a>	European	CEE 7/16	IEC 320/C7	2000
<a href="#">451J3401M8703(R)</a>	Japan	JIS 8303	IEC 320/C7	1830
<a href="#">2044112M703A(R)</a>	Korea	KS C 8305	IEC 320/C7	2000
<a href="#">4033401M8703A(R)</a>	Taiwan	CNS 10917	IEC 320/C7	1800
<a href="#">6104112M703A(R)</a>	UK	BS1363	IEC 320/C7	2000

GlobTek, Inc. www.globtek.com 186 Veterans Drive, Northvale, NJ 07647 Tel. (201) 784-1000 Fax (201) 784-0111	Drawing Title: GT-46240-2412-T2, ITE Power Supply, Efficiency Level: VI, Case Color/Style: GlobTek Black, Desktop/External, Regulated Switchmode AC-DC Power Supply AC Adaptor, Input Rating: 100-240V~, 50-60 Hz, IEC 60320/C8 , Output Rating: 24W, 12V@2A, Output Configuration: 1530 mm, 18/2 Cond, UL 2468, Female Barrel 5.5*2.1*11mm WITH internal Spring Clip and Locking Notch or Equal, Ferrite: Core Size: 14.2*28.5*8.2, GlobTek Black, GT Cord # C5225, Pin Out: Center Positive (+V), Blades/Input Cord: Not Applicable, Approvals: EAC Level VI WEEE cUL 230V CoC Tier 2 CE China RoHS IP42 LPS PSE RoHS Ukraine VCCI Double Insulation S-Mark CB RCM	
	Model No. GT-46240-2412-T2	
	Part No./Ordering No. TR9KE2000CCP-N(R6B)	Rev C1

**OUTPUT CORD AND CONNECTOR: C1S/C5225**

ACTUAL CONNECTORS, OVERMOLDS, FERRITES MAY VARY SLIGHTLY FROM THE PICTURE BELOW

CABLE TYPE	UL 2468
CABLE LENGTH (mm)	1530
CABLE TOLERANCE (mm)	+150,-0
WIRE GAUGE (AWG)	18
CONDUCTORS	2
HANK DIMENSION (mm)	95 ± 10
CABLE / CONNECTOR OVERMOLD COLOR	GlobTek Black
FERRITE TYPE / DIMENSION	Core Size: 14.2*28.5*8.2
FERRITE # OF TURNS ( <a href="#">Definition</a> )	2 Pass thru core (1 turns)
FERRITE DIMENSION FROM STRAIN RELIEF	50 ± 10
FERRITE DIMENSION FROM PLUG	N/A
PLUG TYPE	Female Barrel 5.5*2.1*11mm WITH internal Spring Clip and Locking Notch or Equal
OVER MOLD ORIENTATION	Straight
CONNECTOR PIN OUT:	Center Positive (+V)
ADDITIONAL REQUIREMENTS	

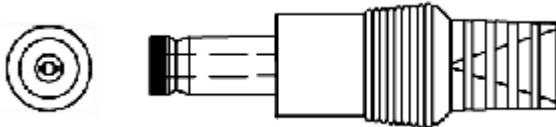

ADDITIONAL OUTPUT PLUG OPTIONS ARE AVAILABLE AT

<http://www.globtek.com/connectors/>

STANDARD PLUGS AND CONNECTORS CAN BE SEEN ONLINE AT <http://www.globtek.com/connectors/>

GlobTek, Inc. www.globtek.com 186 Veterans Drive, Northvale, NJ 07647 Tel. (201) 784-1000 Fax (201) 784-0111	Drawing Title: GT-46240-2412-T2, ITE Power Supply, Efficiency Level: VI, Case Color/Style: GlobTek Black, Desktop/External, Regulated Switchmode AC-DC Power Supply AC Adaptor, Input Rating: 100-240V~, 50-60 Hz, IEC 60320/C8, Output Rating: 24W, 12V@2A, Output Configuration: 1530 mm, 18/2 Cond, UL 2468, Female Barrel 5.5*2.1*11mm WITH internal Spring Clip and Locking Notch or Equal, Ferrite: Core Size: 14.2*28.5*8.2, GlobTek Black, GT Cord # C5225, Pin Out: Center Positive (+V), Blades/Input Cord: Not Applicable, Approvals: EAC Level VI WEEE cUL 230V CoC Tier 2 CE China RoHS IP42 LPS PSE RoHS Ukraine VCCI Double Insulation S-Mark CB RCM	
	Model No. GT-46240-2412-T2	
	Part No./Ordering No. TR9KE2000CCP-N(R6B)	Rev C1

**LABEL:L-1186**

**LABEL P/N:** Standard GT  
**MATERIAL:** Flat Thermal Transfer, Imprintable, Polyester Label and/or Pad Printed and/or Molded, and/or Laser Engraved in the case  
**BACKGROUND COLOR:** Black if housing is Black, White or Silver if housing is White or Gray.  
**TEXT COLOR:** White or Silver if label is Black Background for Black housing. Black if label is White or Silver background and Housing is White or Gray  
**LABEL WIDTH (mm):** 39.6  
**LABEL HEIGHT (mm):** 59.6

Below is the minimum information which will appear on the label. NOTE: in the logo area additional/actual positioning of symbols and text is subjected to change as per agency updates/requirements or additional model approvals become available. Regulatory certifications/label markings may be in logo area on the label or molded into the case housing outside the label area. Information will be shown via label and/or pad printed and/or molded and/or laser engraved in the case. \* Date code markings at GlobTek option.

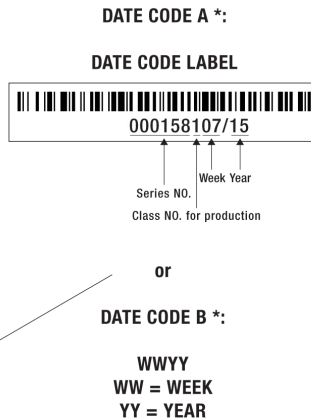

A=ITE Power Supply  
 B=P/N: (料号) TR9KE2000CCP-N(R6B)  
 C=Model (型号) GT-46240-2412-T2  
 D=Input (输入) 100-240V~, 50-60 Hz, 0.6 A  
 E=Output (输出) 12 V  $\overline{\text{---}}$  2 A ,24.0W

AGENCY ONLINE DOCUMENTS <http://www.globtek.info/certs/GT-46240-24VV-x.x-TZ/>  
 CE EC-Declaration for Medical [Contact GlobTek for more information](#)  
 CE EC-Declaration for Industrial/Commercial/ITE [http://www.globtek.com/pdf/ec\\_declaration/a0Oa000000MnJ4QEAV](http://www.globtek.com/pdf/ec_declaration/a0Oa000000MnJ4QEAV)  
 RoHS/RoHS2 Declaration [http://www.globtek.com/pdf/rohs\\_cert/01ta0000005yKGtAAM](http://www.globtek.com/pdf/rohs_cert/01ta0000005yKGtAAM)  
 REACH Declaration [http://www.globtek.com/pdf/iso\\_certificates/REACH.pdf](http://www.globtek.com/pdf/iso_certificates/REACH.pdf)



GlobTek, Inc. www.globtek.com 186 Veterans Drive, Northvale, NJ 07647 Tel. (201) 784-1000 Fax (201) 784-0111	Drawing Title: GT-46240-2412-T2, ITE Power Supply, Efficiency Level: VI, Case Color/Style: GlobTek Black, Desktop/External, Regulated Switchmode AC-DC Power Supply AC Adaptor, Input Rating: 100-240V~, 50-60 Hz, IEC 60320/C8 , Output Rating: 24W, 12V@2A, Output Configuration: 1530 mm, 18/2 Cond, UL 2468, Female Barrel 5.5*2.1*11mm WITH internal Spring Clip and Locking Notch or Equal, Ferrite: Core Size: 14.2*28.5*8.2, GlobTek Black, GT Cord # C5225, Pin Out: Center Positive (+V), Blades/Input Cord: Not Applicable, Approvals: EAC Level VI WEEE cUL 230V CoC Tier 2 CE China RoHS IP42 LPS PSE RoHS Ukraine VCCI Double Insulation S-Mark CB RCM	
	Model No. GT-46240-2412-T2	
	Part No./Ordering No. TR9KE2000CCP-N(R6B)	Rev C1

Conflict Minerals Declaration

<http://www.globtek.com/pdf/conflict-minerals.pdf>

IPXY rating is based on 3rd party testing and customers should check suitability and test system level IPXY rating before ordering.

## Regulatory Certifications/Label Markings

LATEST PRODUCT/MODEL CERTIFICATIONS: <http://en.globtek.com/datasheet/id/a0Oa000000MnJ4Q>

AGENCY ONLINE DOCUMENTS: <http://www.globtek.info/certs/GT-46240-24VV-x.x-TZ/>

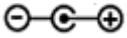

Center Positive (+V)

GlobTek, Inc. www.globtek.com 186 Veterans Drive, Northvale, NJ 07647 Tel. (201) 784-1000 Fax (201) 784-0111	Drawing Title: GT-46240-2412-T2, ITE Power Supply, Efficiency Level: VI, Case Color/Style: GlobTek Black, Desktop/External, Regulated Switchmode AC-DC Power Supply AC Adaptor, Input Rating: 100-240V~, 50-60 Hz, IEC 60320/C8 , Output Rating: 24W, 12V@2A, Output Configuration: 1530 mm, 18/2 Cond, UL 2468, Female Barrel 5.5*2.1*11mm WITH internal Spring Clip and Locking Notch or Equal, Ferrite: Core Size: 14.2*28.5*8.2, GlobTek Black, GT Cord # C5225, Pin Out: Center Positive (+V), Blades/Input Cord: Not Applicable, Approvals: EAC Level VI WEEE cUL 230V CoC Tier 2 CE China RoHS IP42 LPS PSE RoHS Ukraine VCCI Double Insulation S-Mark CB RCM	
	Model No. GT-46240-2412-T2	
	Part No./Ordering No. TR9KE2000CCP-N(R6B)	Rev C1

## PACKAGING

Packing Spec P/N: Standard DT, Individually  
Box  
Box Qty: 72  
Gift Box Size (mm): 125\*58\*60  
Gift Box Color: White  
Master Carton Size (mm): 510\*350\*272  
Master GW (Kg): 8.4 kg  
BLADES INCLUDED: N/A:  
BLADE/CORD INSTALLED: N/A:

If specific packaging is required, this section must specify all requirements and note "no exceptions". If this section does not specify packaging, it is subject to change without notice at GlobTek's discretion

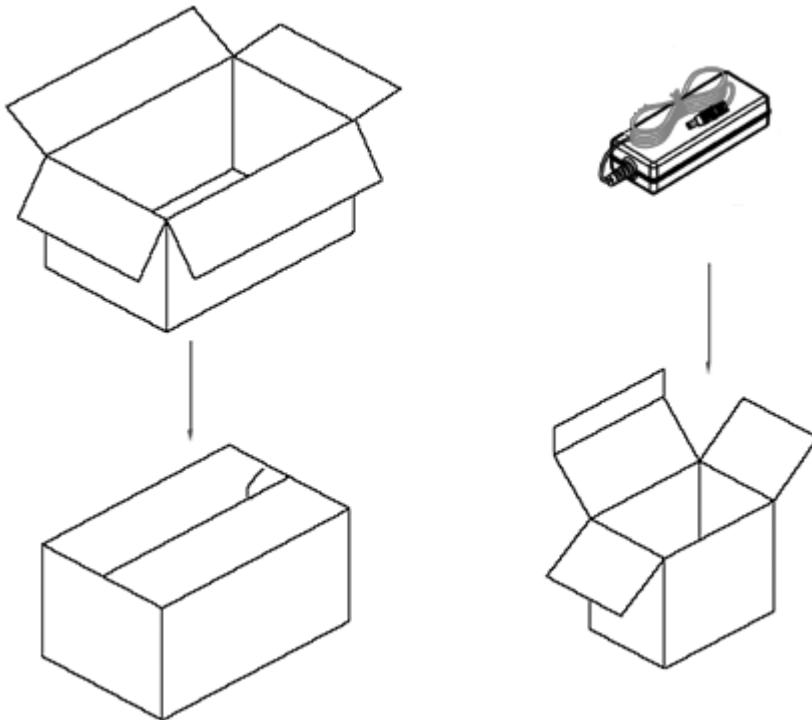

GlobTek, Inc. www.globtek.com 186 Veterans Drive, Northvale, NJ 07647 Tel. (201) 784-1000 Fax (201) 784-0111	Drawing Title: GT-46240-2412-T2, ITE Power Supply, Efficiency Level: VI, Case Color/Style: GlobTek Black, Desktop/External, Regulated Switchmode AC-DC Power Supply AC Adaptor, Input Rating: 100-240V~, 50-60 Hz, IEC 60320/C8 , Output Rating: 24W, 12V@2A, Output Configuration: 1530 mm, 18/2 Cond, UL 2468, Female Barrel 5.5*2.1*11mm WITH internal Spring Clip and Locking Notch or Equal, Ferrite: Core Size: 14.2*28.5*8.2, GlobTek Black, GT Cord # C5225, Pin Out: Center Positive (+V), Blades/Input Cord: Not Applicable, Approvals: EAC Level VI WEEE cUL 230V CoC Tier 2 CE China RoHS IP42 LPS PSE RoHS Ukraine VCCI Double Insulation S-Mark CB RCM	
	Model No. GT-46240-2412-T2	
	Part No./Ordering No. TR9KE2000CCP-N(R6B)	Rev C1

INSTRUCTION SHEET

N/A