



| Product Specifications | | |
|------------------------|-----------------|----------|
| PART NO.: | VL47B2863A-F8SE | REV: 1.0 |

General Information

1GB 128Mx64 DDR3 SDRAM NON-ECC UNBUFFERED SODIMM 204-PIN

Description

The VL47B2863A is a 128Mx64 DDR3 SDRAM high density SODIMM. This single rank memory module consists of eight CMOS 128Mx8 bits with 8 banks DDR3 Synchronous DRAMs in BGA packages and a 2K EEPROM with thermal sensor in an 8-pin MLF package. This module is a 204-pin small-outline dual in-line memory module and is intended for mounting into an edge connector socket. Decoupling capacitors are mounted on the printed circuit board for each DDR3 SDRAM.

Features

- 204-pin, small-outline dual in-line memory module (SODIMM)
- Fast data transfer rate: PC3-8500
- VDD = VDDQ = 1.5V +/-0.075V
- JEDEC standard 1.5V +/-0.075V I/O (SSTL_15 compatible)
- VDDSPD = 3.0V to 3.6V
- Eight internal component banks for concurrent operation
- 8-bit pre-fetch architecture
- Bi-directional differential data-strobe
- Nominal and dynamic on-die termination (ODT)
- ZQ calibration support
- Programmable CAS# latency: 7 (DDR3-1066)
- Programmable burst; length (8)
- Average refresh period 7.8 us
- Asynchronous reset
- Fly-by topology
- On board terminated command, address, and control bus
- Serial presence detect (SPD) EEPROM with thermal sensor
- Thermal sensor range: -40°C to +125°C (Max +/-3°C accuracy)
- JEDEC pinout
- Gold edge contacts
- Lead-free, RoHS compliant
- PCB: Height 30.00mm (1.181"), double sided component
- Operating temperature (TOPER): - Commercial (0°C <= Tc <= 95°C)
- Industrial (-40°C <= Tc <= 95°C)

Notes: Double refresh rate is required when 85°C < TOPER <= 95°C.
TOPER is DRAM case temperature (Tc)

Pin Description

| Pin Name | Function |
|-------------|------------------------------|
| A0~A13 | Address Inputs |
| A10/AP | Address Input/ Autoprecharge |
| A12/BC# | Address Input/ Burst Chop |
| BA0~BA2 | Bank Address Inputs |
| DQ0~DQ63 | Data Input/Output |
| DQS0~DQS7 | Data Stobes |
| DQS0#~DQS7# | Data Stobes Complement |
| DM0~DM7 | Data Masks |
| CK0, CK0# | Clock Input |
| ODT0 | On-die Termination Control |
| CKE0 | Clock Enables |
| CS0# | Chip Selects |
| RAS# | Row Address Stobes |
| CAS# | Column Address Stobes |
| WE# | Write Enable |
| RESET# | Register and SDRAM Control |
| VDD | Voltage Supply |
| VSS | Ground |
| SA0~SA1 | SPD Address |
| SDA | SPD Data Input/Output |
| SCL | SPD Clock Input |
| EVENT# | Temperature Event Output |
| VREFCA | Reference Voltage for CA |
| VREFDQ | Reference Voltage for DQ |
| VDDSPD | SPD Voltage Supply |
| VTT | Termination Voltage |
| NC | No Connect |

Order Information:

VL47B2863A - F8 S E - X

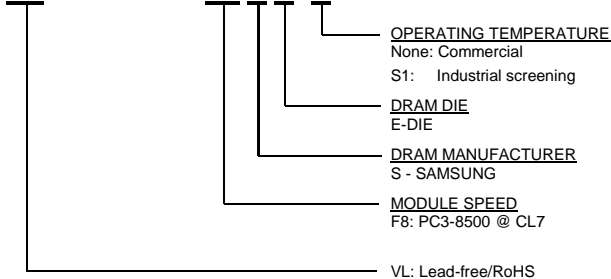

Dram component: Samsung K4B1G0846E-BCH9



Product Specifications

PART NO.:

VL47B2863A-F8SE

REV: 1.0

Pin Configuration

| 204-PIN DDR3 SODIMM FRONT | | | | | | | | 204-PIN DDR3 SODIMM BACK | | | | | | | |
|---------------------------|--------|-----|------|-----|-------|-----|--------|--------------------------|--------|-----|-------|-----|--------|-----|--------|
| Pin | Name | Pin | Name | Pin | Name | Pin | Name | Pin | Name | Pin | Name | Pin | Name | | |
| 1 | VREFDQ | 53 | DQ19 | 105 | VDD | 157 | DQ42 | 2 | VSS | 54 | VSS | 106 | VDD | 158 | DQ46 |
| 3 | VSS | 55 | VSS | 107 | A10 | 159 | DQ43 | 4 | DQ4 | 56 | DQ28 | 108 | BA1 | 160 | DQ47 |
| 5 | DQ0 | 57 | DQ24 | 109 | BA0 | 161 | VSS | 6 | DQ5 | 58 | DQ29 | 110 | RAS# | 162 | VSS |
| 7 | DQ1 | 59 | DQ25 | 111 | VDD | 163 | DQ48 | 8 | VSS | 60 | VSS | 112 | VDD | 164 | DQ52 |
| 9 | VSS | 61 | VSS | 113 | WE# | 165 | DQ49 | 10 | DQS0# | 62 | DQS3# | 114 | CS0# | 166 | DQ53 |
| 11 | DM0 | 63 | DM3 | 115 | CAS# | 167 | VSS | 12 | DQS0 | 64 | DQS3 | 116 | ODT0 | 168 | VSS |
| 13 | VSS | 65 | VSS | 117 | VDD | 169 | DQS6# | 14 | VSS | 66 | VSS | 118 | VDD | 170 | DM6 |
| 15 | DQ2 | 67 | DQ26 | 119 | A13 | 171 | DQS6 | 16 | DQ6 | 68 | DQ30 | 120 | ODT1* | 172 | VSS |
| 17 | DQ3 | 69 | DQ27 | 121 | CS1#* | 173 | VSS | 18 | DQ7 | 70 | DQ31 | 122 | NC | 174 | DQ54 |
| 19 | VSS | 71 | VSS | 123 | VDD | 175 | DQ50 | 20 | VSS | 72 | VSS | 124 | VDD | 176 | DQ55 |
| 21 | DQ8 | 73 | CKE0 | 125 | NC | 177 | DQ51 | 22 | DQ12 | 74 | CKE1* | 126 | VREFCA | 178 | VSS |
| 23 | DQ9 | 75 | VDD | 127 | VSS | 179 | VSS | 24 | DQ13 | 76 | VDD | 128 | VSS | 180 | DQ60 |
| 25 | VSS | 77 | NC | 129 | DQ32 | 181 | DQ56 | 26 | VSS | 78 | A15 * | 130 | DQ36 | 182 | DQ61 |
| 27 | DQS1# | 79 | BA2 | 131 | DQ33 | 183 | DQ57 | 28 | DM1 | 80 | A14 * | 132 | DQ37 | 184 | VSS |
| 29 | DQS1 | 81 | VDD | 133 | VSS | 185 | VSS | 30 | RESET# | 82 | VDD | 134 | VSS | 186 | DQS7# |
| 31 | VSS | 83 | A12 | 135 | DQS4# | 187 | DM7 | 32 | VSS | 84 | A11 | 136 | DM4 | 188 | DQS7 |
| 33 | DQ10 | 85 | A9 | 137 | DQS4 | 189 | VSS | 34 | DQ14 | 86 | A7 | 138 | VSS | 190 | VSS |
| 35 | DQ11 | 87 | VDD | 139 | VSS | 191 | DQ58 | 36 | DQ15 | 88 | VDD | 140 | DQ38 | 192 | DQ62 |
| 37 | VSS | 89 | A8 | 141 | DQ34 | 193 | DQ59 | 38 | VSS | 90 | A6 | 142 | DQ39 | 194 | DQ63 |
| 39 | DQ16 | 91 | A5 | 143 | DQ35 | 195 | VSS | 40 | DQ20 | 92 | A4 | 144 | VSS | 196 | VSS |
| 41 | DQ17 | 93 | VDD | 145 | VSS | 197 | SA0 | 42 | DQ21 | 94 | VDD | 146 | DQ44 | 198 | EVENT# |
| 43 | VSS | 95 | A3 | 147 | DQ40 | 199 | VDDSPD | 44 | VSS | 96 | A2 | 148 | DQ45 | 200 | SDA |
| 45 | DQS2# | 97 | A1 | 149 | DQ41 | 201 | SA1 | 46 | DM2 | 98 | A0 | 150 | VSS | 202 | SCL |
| 47 | DQS2 | 99 | VDD | 151 | VSS | 203 | VTT | 48 | VSS | 100 | VDD | 152 | DQS5# | 204 | VTT |
| 49 | VSS | 101 | CK0 | 153 | DM5 | | | 50 | DQ22 | 102 | CK1* | 154 | DQS5 | | |
| 51 | DQ18 | 103 | CK0# | 155 | VSS | | | 52 | DQ23 | 104 | CK1#* | 156 | VSS | | |

*: These pins are not used in this module.

Function Block Diagram

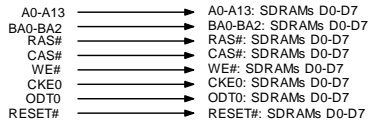
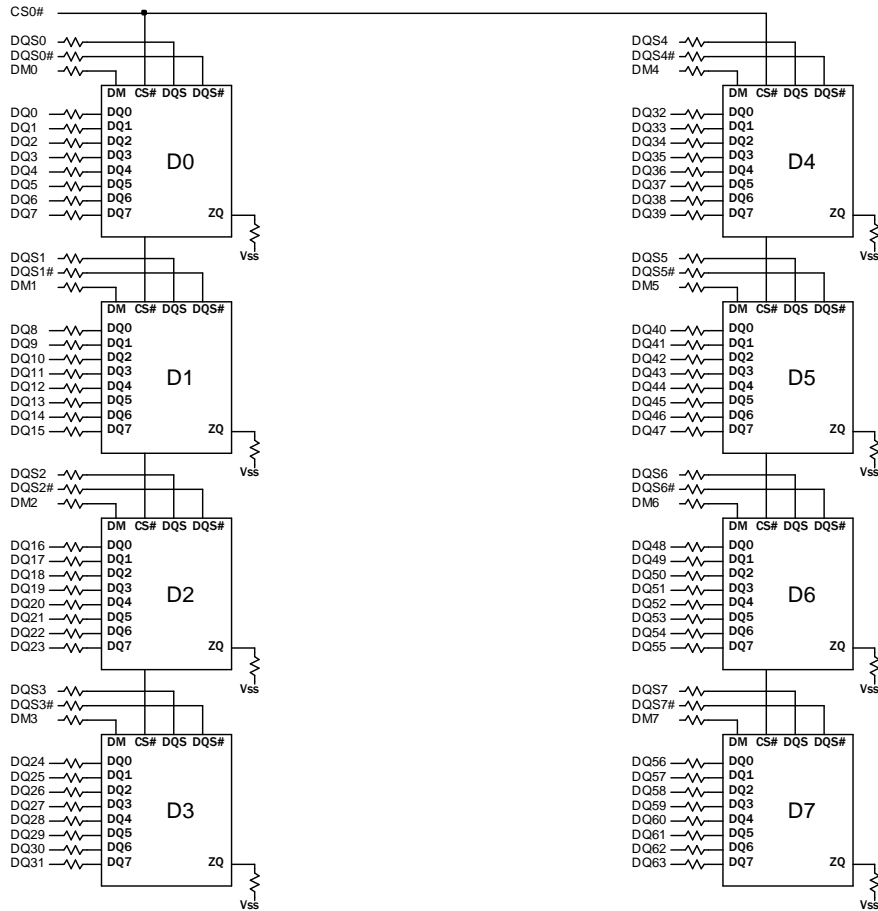

Command, address, control, and clock line terminations

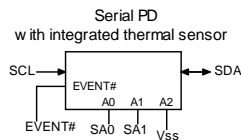
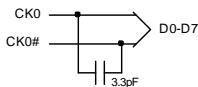
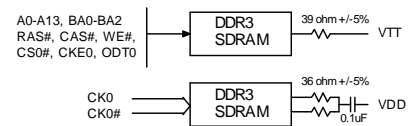

Notes:

1. Unless otherwise noted, resistor values are 15 ohms +/-5%
2. ZQ resistors are 240 ohms +/-1%

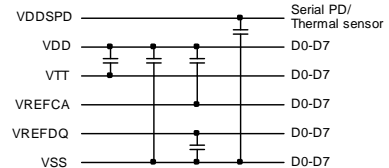



Product Specifications

PART NO.:

VL47B2863A-F8SE

REV: 1.0

Absolute Maximum Ratings

| Symbol | Parameter | Min | Max | Unit | |
|-----------|--|------------------------------|-------|------|----|
| VDD | Voltage on VDD pin relative to VSS | -0.4 | 1.975 | V | |
| VDDQ | Voltage on VDDQ pin relative to VSS | -0.4 | 1.975 | V | |
| VIN, VOUT | Voltage on any pin relative to VSS | -0.4 | 1.975 | V | |
| TSTG | Storage temperature | -55 | 100 | °C | |
| IL | Input leakage current; Any input 0V<VIN<VDD; VREF input 0V<VIN<0.95V; Other pins not under test = 0V | Address, RAS#, CAS#, WE#, BA | -16 | 16 | uA |
| | | CS#, CKE, ODT, CK, CK# | -16 | 16 | uA |
| | | DM | -2 | 2 | uA |
| IOZ | Output leakage current; 0V<VOUT<VDDQ; DQs and ODT are disabled | DQ, DQS, DQS# | -5 | 5 | uA |
| IVREF | VREF supply leakage current; VREF = Valid VREF level | -8 | 8 | uA | |

DC Operating Conditions

| Symbol | Parameter | Min | Typical | Max | Unit | Notes |
|-------------|-------------------------------------|---------------|------------|---------------|------|-------|
| VDD | Supply Voltage | 1.425 | 1.5 | 1.575 | V | 1,2 |
| VDDQ | I/O Supply Voltage | 1.425 | 1.5 | 1.575 | V | 1,2 |
| VREFDQ (DC) | I/O reference voltage DQ bus | 0.49 x VDD | 0.5 x VDD | 0.51 x VDD | V | 3,4 |
| VREFCA (DC) | Input reference voltage CMD/ADD bus | 0.49 x VDD | 0.5 x VDD | 0.51 x VDD | V | 3,4 |
| VTT | Termination Reference Voltage | -0.483 x VDDQ | 0.5 x VDDQ | +0.517 x VDDQ | V | 5 |

Notes:

1. Under all conditions VDDQ must be less than or equal to VDD.
2. VDDQ tracks with VDD. AC parameters are measured with VDD and VDDQ tied together.
3. The AC peak noise on VREF may not allow VREF to deviate from VREF(DC) by more than +/-1% VDD
4. For reference: approximate VDD/2 +/-15mV.
5. VTT termination voltage in excess of stated limit will adversely affect the command and address signals' voltage margin and will reduce timing margins.

Operating Temperature Condition

| Symbol | Parameter | Rating | Units | Notes |
|--------|-----------------------|------------|-------|-------|
| TOPER | Operating temperature | Commercial | °C | 1,2 |
| | | Industrial | | |

Notes:

1. Operating temperature is the case surface temperature on the center/top side of the DRAM. For the measurement conditions, please refer to JEDEC JESD51-2.
2. At -40 to +85°C, operation temperature range, all DRAM specifications will be supported. The refresh rate is required to double when 85°C < TOPER <= 95°C.



| Product Specifications | | |
|------------------------|-----------------|----------|
| PART NO.: | VL47B2863A-F8SE | REV: 1.0 |

| Input DC Logic Level | | | | |
|--------------------------------|------------------------------|--------------|--------------|------|
| All voltages referenced to VSS | | | | |
| Symbol | Parameter | Min | Max | Unit |
| Command and Address | | | | |
| VIHCA(DC) | Input High (Logic 1) Voltage | VREF + 0.100 | VDD | V |
| VILCA(DC) | Input Low (Logic 0) Voltage | VSS | VREF - 0.100 | V |
| DQ and DM | | | | |
| VIHDQ(DC) | Input High (Logic 1) Voltage | VREF + 0.100 | VDD | V |
| VILDQ(DC) | Input Low (Logic 0) Voltage | VSS | VREF - 0.100 | V |

| Input AC Logic Level | | | | |
|--------------------------------|------------------------------|--------------|--------------|------|
| All voltages referenced to VSS | | | | |
| Symbol | Parameter | Min | Max | Unit |
| Command and Address | | | | |
| VIHCA(AC) | Input High (Logic 1) Voltage | VREF + 0.175 | - | V |
| VILCA(AC) | Input Low (Logic 0) Voltage | - | VREF - 0.175 | V |
| DQ and DM | | | | |
| VIHDQ(AC) | Input High (Logic 1) Voltage | VREF + 0.175 | - | V |
| VILDQ(AC) | Input Low (Logic 0) Voltage | - | VREF - 0.175 | V |

| Input/Output Capacitance | | | | |
|--|--------|-------------------|------|------|
| TA=25°C, f=100MHz | | | | |
| Parameter | Symbol | F8 (DDR3-1066) | | Unit |
| | | Min | Max | |
| Input capacitance (A0~A13, BA0~BA2, RAS#, CAS#, WE#) | CIN1 | 10 | 16 | pF |
| Input capacitance (CKE0, ODT0, CS0#) | CIN2 | 10 | 16 | pF |
| Input capacitance (CK0, CK0#) | CIN3 | 10.4 | 16.8 | pF |
| Input/Output capacitance (DQ, DQS, DQS#, DM) | CIO | 5.5 | 6.7 | pF |



Product Specifications

PART NO.:

VL47B2863A-F8SE

REV: 1.0

IDD Specification

| Condition | Symbol | F8 (DDR3-1066) | Unit |
|--|-----------|-------------------|------|
| Operating one bank active-precharge current; tCK= tCK(IDD); tRC= tRC(IDD); tRAS= tRAS MIN(IDD); CKE is HIGH, CS# is HIGH between valid commands; Address bus inputs are SWITCHING; Data bus inputs are SWITCHING | IDD0* | 480 | mA |
| Operating one bank active-read-precharge current; IOUT = 0mA; BL = 8; CL = CL(IDD); AL = 0; tCK= tCK(IDD); tRC= tRC(IDD); tRAS= tRAS MIN(IDD); tRCD= tRCD(IDD); CKE is HIGH, CS# is HIGH between valid commands; Address bus inputs are SWITCHING; Data pattern is same as IDD4W. | IDD1* | 600 | mA |
| Precharge power-down current; All device banks idle; tCK= tCK(IDD); CKE is LOW; Other control and address bus inputs are STABLE; Data bus inputs are FLOATING | IDD2P-F** | 200 | mA |
| | IDD2P-S** | 80 | mA |
| Precharge standby current; All device banks idle; tCK= tCK(IDD); CKE is HIGH; CS# is HIGH; Other control and address bus inputs are SWITCHING; Data bus inputs are SWITCHING. | IDD2N** | 240 | mA |
| Precharge quiet standby current; All device banks idle; tCK= tCK(IDD); CKE is HIGH; CS# is HIGH; Other control and address bus inputs are STABLE; Data bus inputs are FLOATING | IDD2Q** | 240 | mA |
| Active power-down current; All device banks open; tCK= tCK(IDD); CKE is LOW; Other control and address bus inputs are STABLE; Data bus inputs are FLOATING. | IDD3P** | 200 | mA |
| Active standby current; All device banks open; tCK= tCK(IDD); tRP= tRP(IDD); tRAS= tRAS MAX(IDD); CKE is HIGH, CS# is HIGH between valid commands; Other control and address bus inputs are SWITCHING; Data bus inputs are SWITCHING. | IDD3N** | 360 | mA |
| Operating burst read current; All device banks open; Continuous burst reads; IOUT = 0mA; BL = 8; CL = CL(IDD); AL = 0; tCK= tCK(IDD); tRAS= tRAS MAX(IDD); tRP= tRP(IDD); CKE is HIGH, CS# is HIGH between valid commands; Address bus inputs are SWITCHING; Data pattern is same as IDD4W. | IDD4R* | 880 | mA |
| Operating burst write current; All device banks open; Continuous burst writes; BL = 8; CL = CL(IDD); AL = 0; tCK= tCK(IDD); tRAS= tRAS MAX(IDD); tRP= tRP(IDD); CKE is HIGH, CS# is HIGH between valid commands; Address bus inputs are SWITCHING; Data bus inputs are SWITCHING. | IDD4W* | 920 | mA |
| Burst refresh current; tCK=tCK(IDD); Refresh command at every tRFC(IDD) interval; CKE is HIGH; CS# is HIGH between valid commands; Other control and address bus inputs are SWITCHING; Data bus inputs are SWITCHING. | IDD5** | 1200 | mA |
| Self refresh current; CK and CK# at 0V; CKE < 0.2V; Other control and address bus inputs are FLOATING; Data bus inputs are FLOATING. | IDD6** | 80 | mA |
| Operating bank interleave read current; All bank interleaving reads; IOUT = 0mA; BL = 8; CL = CL(IDD); AL = tRCD(IDD) - 1*tCK(IDD); tCK= tCK(IDD); tRC= tRC(IDD); tRRD = tRRD(IDD); tRCD = 1*tCK(IDD); CKE is HIGH; CS# is HIGH between valid commands; Address bus inputs are STABLE during DESELECTs; Data pattern is same as IDD4R. | IDD7* | 1480 | mA |

Note: IDD specification is based on Samsung E-die components.

*: Value calculated as one module rank in this operating condition, and all other module ranks in IDD2P (CKE LOW) mode.

** : Value calculated reflects all module ranks in this operating condition.



Product Specifications

PART NO.:

VL47B2863A-F8SE

REV: 1.0

AC TIMING PARAMETERS & SPECIFICATIONS

| Parameter | Symbol | K0 (DDR3-1600) | | K9 (DDR3-1333) | | F8 (DDR3-1066) | | Unit |
|--|----------------------|--|----------------------------------|----------------------------------|----------------------------------|----------------------------------|----------------------------------|----------|
| | | MIN | MAX | MIN | MAX | MIN | MAX | |
| Clock Timing | | | | | | | | |
| Minimum Clock Cycle Time (DLL off mode) | tCK(DLL_OFF) | 8 | - | 8 | - | 8 | - | ns |
| Average Clock Period | tCK(avg) | 1.25 | <1.50 | 1.5 | <1.875 | 1.875 | <2.5 | ns |
| Clock Period | tCK(abs) | tCK(avg)min + tJIT(per)min | tCK(avg)max + tJIT(per)max | tCK(avg)min + tJIT(per)min | tCK(avg)max + tJIT(per)max | tCK(avg)min + tJIT(per)min | tCK(avg)max + tJIT(per)max | ns |
| Average high pulse width | tCH(avg) | 0.47 | 0.53 | 0.47 | 0.53 | 0.47 | 0.53 | tCK(avg) |
| Average low pulse width | tCL(avg) | 0.47 | 0.53 | 0.47 | 0.53 | 0.47 | 0.53 | tCK(avg) |
| Clock Period Jitter | tJIT(per) | -70 | 70 | -80 | 80 | -90 | 90 | ps |
| Clock Period Jitter during DLL locking period | tJIT(per, lck) | -60 | 60 | -70 | 70 | -80 | 80 | ps |
| Cycle to Cycle Period Jitter | tJIT(cc) | 140 | | 160 | | 180 | | ps |
| Cycle to Cycle Period Jitter during DLL locking period | tJIT(cc, lck) | 120 | | 140 | | 160 | | ps |
| Cumulative error across 2 cycles | tERR(2per) | -103 | 103 | -118 | 118 | -132 | 132 | ps |
| Cumulative error across 3 cycles | tERR(3per) | -122 | 122 | -140 | 140 | -157 | 157 | ps |
| Cumulative error across 4 cycles | tERR(4per) | -136 | 136 | -155 | 155 | -175 | 175 | ps |
| Cumulative error across 5 cycles | tERR(5per) | -147 | 147 | -168 | 168 | -188 | 188 | ps |
| Cumulative error across 6 cycles | tERR(6per) | -155 | 155 | -177 | 177 | -200 | 200 | ps |
| Cumulative error across 7 cycles | tERR(7per) | -163 | 163 | -186 | 186 | -209 | 209 | ps |
| Cumulative error across 8 cycles | tERR(8per) | -169 | 169 | -193 | 193 | -217 | 217 | ps |
| Cumulative error across 9 cycles | tERR(9per) | -175 | 175 | -200 | 200 | -224 | 224 | ps |
| Cumulative error across 10 cycles | tERR(10per) | -180 | 180 | -205 | 205 | -231 | 231 | ps |
| Cumulative error across 11 cycles | tERR(11per) | -184 | 184 | -210 | 210 | -237 | 237 | ps |
| Cumulative error across 12 cycles | tERR(12per) | -188 | 188 | -215 | 215 | -242 | 242 | ps |
| Cumulative error across n = 13, 14 ... 49, 50 cycles | tERR(nper) | $tERR(nper)min=(1+0.68ln(n))*tJIT(per)min$ $tERR(nper)max=(1+0.68ln(n))*tJIT(per)max$ | | | | | | ps |
| Absolute clock HIGH pulse width | tCH(abs) | 0.43 | - | 0.43 | - | 0.43 | - | tCK(avg) |
| Absolute clock Low pulse width | tCL(abs) | 0.43 | - | 0.43 | - | 0.43 | - | tCK(avg) |
| Data Timing | | | | | | | | |
| DQS,DQS# to DQ skew, per group, per access | tDQSQ | - | 100 | - | 125 | - | 150 | ps |
| DQ output hold time from DQS, DQS# | tQH | 0.38 | - | 0.38 | - | 0.38 | - | tCK(avg) |
| DQ low-impedance time from CK, CK# | tLZ(DQ) | -450 | 225 | -500 | 250 | -600 | 300 | ps |
| DQ high-impedance time from CK, CK# | tHZ(DQ) | - | 225 | - | 250 | - | 300 | ps |
| Data setup time to DQS, DQS# referenced to Vih(ac)Vil(ac) levels | tDS(base) (AC175) | - | - | - | - | 25 | - | ps |
| Data setup time to DQS, DQS# referenced to Vih(ac)Vil(ac) levels | tDS(base) (AC150) | 10 | - | 30 | - | - | - | ps |
| Data hold time to DQS, DQS# referenced to Vih(ac)Vil(ac) levels | tDH(base) | 45 | - | 65 | - | 100 | - | ps |
| DQ and DM Input pulse width for each input | tDIPW | 360 | - | 400 | - | 490 | - | ps |



Product Specifications

PART NO.:

VL47B2863A-F8SE

REV: 1.0

AC TIMING PARAMETERS & SPECIFICATIONS

| Parameter | Symbol | K0 (DDR3-1600) | | K9 (DDR3-1333) | | F8 (DDR3-1066) | | Unit |
|---|----------------------|-------------------------------|---------|----------------------|---------|----------------------|---------|----------|
| | | MIN | MAX | MIN | MAX | MIN | MAX | |
| Data Strobe Timing | | | | | | | | |
| DQS, DQS# READ Preamble | tRPRE | 0.9 | - | 0.9 | - | 0.9 | - | tCK |
| DQS, DQS# differential READ Postamble | tRPST | 0.3 | - | 0.3 | - | 0.3 | - | tCK |
| DQS, DQS# output high time | tQSH | 0.4 | - | 0.4 | - | 0.38 | - | tCK(avg) |
| DQS, DQS# output low time | tQSL | 0.4 | - | 0.4 | - | 0.38 | - | tCK(avg) |
| DQS, DQS# WRITE Preamble | tWPRE | 0.9 | - | 0.9 | - | 0.9 | - | tCK |
| DQS, DQS# WRITE Postamble | tWPST | 0.3 | - | 0.3 | - | 0.3 | - | tCK |
| DQS, DQS# rising edge output access time from rising CK, CK# | tDQSCK | -225 | 225 | -255 | 255 | -300 | 300 | ps |
| DQS, DQS# low-impedance time (Referenced from RL-1) | tLZ(DQS) | -450 | 225 | -500 | 250 | -600 | 300 | ps |
| DQS, DQS# high-impedance time (Referenced from RL+BL/ 2) | tHZ(DQS) | - | 225 | - | 250 | - | 300 | ps |
| DQS, DQS# differential input low pulse width | tDQSL | 0.45 | 0.55 | 0.45 | 0.55 | 0.45 | 0.55 | tCK |
| DQS, DQS# differential input high pulse width | tDQSH | 0.45 | 0.55 | 0.45 | 0.55 | 0.45 | 0.55 | tCK |
| DQS, DQS# rising edge to CK, CK# rising edge | tDQSS | -0.27 | 0.27 | -0.25 | 0.25 | -0.25 | 0.25 | tCK(avg) |
| DQS, DQS# falling edge setup time to CK, CK# rising edge | tDSS | 0.18 | - | 0.2 | - | 0.2 | - | tCK(avg) |
| DQS, DQS# falling edge hold time to CK, CK# rising edge | tDSH | 0.18 | - | 0.2 | - | 0.2 | - | tCK(avg) |
| Command and Address Timing | | | | | | | | |
| DLL locking time | tDLLK | 512 | - | 512 | - | 512 | - | nCK |
| Internal READ Command to PRECHARGE Command delay | tRTP | max (4tCK, 7.5ns) | - | max (4tCK, 7.5ns) | - | max (4tCK, 7.5ns) | - | |
| Delay from start of internal write transaction to internal read command | tWTR | max (4tCK, 7.5ns) | - | max (4tCK, 7.5ns) | - | max (4tCK, 7.5ns) | - | |
| WRITE recovery time | tWR | 15 | - | 15 | - | 15 | - | ns |
| Mode Register Set command cycle time | tMRD | 4 | - | 4 | - | 4 | - | nCK |
| Mode Register Set command update delay | tMOD | max (12tCK, 15ns) | - | max (12tCK, 15ns) | - | max (12tCK, 15ns) | - | |
| CAS# to CAS# command delay | tCCD | 4 | - | 4 | - | 4 | - | nCK |
| Auto precharge write recovery + precharge time | tDAL(min) | WR + roundup (tRP / tCK(AVG)) | | | | | | nCK |
| Multi-Purpose Register Recovery Time | tMPRR | 1 | - | 1 | - | 1 | - | nCK |
| ACTIVE to PRECHARGE command period | tRAS | 35 | 9*tREFI | 36 | 9*tREFI | 37.5 | 9*tREFI | ns |
| ACTIVE to internal read or write delay time | tRCD | 13.75 | - | 13.5 | - | 13.13 | - | ns |
| PRECHARGE command period | tRP | 13.75 | - | 13.5 | - | 13.13 | - | ns |
| ACTIVE to ACTIVE or REF command period | tRC | 48.75 | - | 49.5 | - | 50.63 | - | ns |
| ACTIVE to ACTIVE command period for 1KB page size | tRRD | max (4tCK, 6ns) | - | max (4tCK, 6ns) | - | max (4tCK, 7.5ns) | - | |
| ACTIVE to ACTIVE command period for 2KB page size | tRRD | max (4tCK, 7.5ns) | - | max (4tCK, 7.5ns) | - | max (4tCK, 10ns) | - | |
| Four activate window for 1KB page size | tFAW | 30 | - | 30 | - | 37.5 | - | ns |
| Four activate window for 2KB page size | tFAW | 40 | - | 45 | - | 50 | - | ns |
| Command and Address setup time to CK, CK# referenced to Vih(ac) / Vil(ac) levels | tIS(base) (AC175) | - | - | - | - | 125 | - | ps |
| Command and Address setup time to CK, CK# referenced to Vih(ac) / Vil(ac) levels | tIS(base) (AC150) | 170 | - | 190 | - | - | - | ps |
| Command and Address hold time from CK, CK# referenced to Vih(ac) / Vil(ac) levels | tIH(base) | 120 | - | 140 | - | 200 | - | ps |
| Control & Address Input pulse width for each input | tIPW | 560 | - | 620 | - | 780 | - | ps |



Product Specifications

PART NO.:

VL47B2863A-F8SE

REV: 1.0

AC TIMING PARAMETERS & SPECIFICATIONS

| Parameter | Symbol | K0 (DDR3-1600) | | K9 (DDR3-1333) | | F8 (DDR3-1066) | | Unit |
|---|----------|-------------------------|---------|-------------------------|---------|-------------------------|---------|------|
| | | MIN | MAX | MIN | MAX | MIN | MAX | |
| Refresh Timing | | | | | | | | |
| 1Gb REFRESH to REFRESH or REFRESH to ACTIVE command interval | tRFC | 110 | - | 110 | - | 110 | - | ns |
| Average periodic refresh interval (0°C ≤ TCASE ≤ 85 °C) | tREFI | 7.8 | - | 7.8 | - | 7.8 | - | us |
| Average periodic refresh interval (85°C ≤ TCASE ≤ 95 °C) | tREFI | 3.9 | - | 3.9 | - | 3.9 | - | us |
| Calibration Timing | | | | | | | | |
| Power-up and RESET calibration time | tZQinitl | 512 | - | 512 | - | 512 | - | tCK |
| Normal operation Full calibration time | tZQoper | 256 | - | 256 | - | 256 | - | tCK |
| Normal operation Short calibration time | tZQCS | 64 | - | 64 | - | 64 | - | tCK |
| Reset Timing | | | | | | | | |
| Exit Reset from CKE HIGH to a valid command | tXPR | max(5tCK, tRFC + 10ns) | - | max(5tCK, tRFC + 10ns) | - | max(5tCK, tRFC + 10ns) | - | |
| Self Refresh Timing | | | | | | | | |
| Exit Self Refresh to commands not requiring a locked DLL | tXS | max(5tC, tRFC+10ns) | - | max(5tC, tRFC+10ns) | - | max(5tC, tRFC + 10ns) | - | |
| Exit Self Refresh to commands requiring a locked DLL | tXSDLL | tDLLK(min) | - | tDLLK(min) | - | tDLLK(min) | - | nCK |
| Minimum CKE low width for Self refresh entry to exit timing | tCKESR | tCKE(min) + 1tCK | - | tCKE(min) + 1tCK | - | tCKE(min) + 1tCK | - | |
| Valid Clock Requirement after Self Refresh Entry (SRE) | tCKSRE | max(5tC, 10ns) | - | max(5tC, 10ns) | - | max(5tC, 10ns) | - | |
| Valid Clock Requirement before Self Refresh Exit (SRX) | tCKSRX | max(5tC, 10ns) | - | max(5tC, 10ns) | - | max(5tC, 10ns) | - | |
| Power Down Timing | | | | | | | | |
| Exit Power Down with DLL to any valid command; Exit Precharge Power Down with DLL frozen to commands not requiring a locked DLL | tXP | max(3tCK, 6ns) | - | max(3tCK, 6ns) | - | max(3tCK, 7.5ns) | - | |
| Exit Precharge Power Down with DLL frozen to commands requiring a locked DLL | tXPDLL | max(10tCK, 24ns) | - | max(10tCK, 24ns) | - | max(10tCK, 24ns) | - | |
| CKE minimum pulse width | tCKE | max(3tCK, 5ns) | - | max(3tCK, 5.625ns) | - | max(3tCK, 5.625ns) | - | |
| Command pass disable delay | tCPDED | 1 | - | 1 | - | 1 | - | nCK |
| Power Down Entry to Exit Timing | tPD | tCKE(min) | 9*tREFI | tCKE(min) | 9*tREFI | tCKE(min) | 9*tREFI | tCK |
| Timing of ACT command to Power Down entry | tACTPDEN | 1 | - | 1 | - | 1 | - | nCK |
| Timing of PRE command to Power Down entry | tPRPDEN | 1 | - | 1 | - | 1 | - | nCK |
| Timing of RD/RDA command to Power Down entry | tRDPDEN | RL + 4 + 1 | - | RL + 4 + 1 | - | RL + 4 + 1 | - | |
| Timing of WR command to Power Down entry BL8 (OTF, MRS), BL4OTF | tWRPDEN | WL + 4 + (tWR/tCK)(avg) | - | WL + 4 + (tWR/tCK)(avg) | - | WL + 4 + (tWR/tCK)(avg) | - | nCK |
| Timing of WRA command to Power Down entry BL8 (OTF, MRS), BL4OTF | tWRAPDEN | WL+4 +WR+1 | - | WL+4 +WR+1 | - | WL+4 +WR+1 | - | nCK |
| Timing of WR command to Power Down entry (BL4MRS) | tWRPDEN | WL + 2 + (tWR/tCK)(avg) | - | WL + 2 + (tWR/tCK)(avg) | - | WL + 2 + (tWR/tCK)(avg) | - | nCK |
| Timing of WRA command to Power Down entry (BL4MRS) | tWRAPDEN | WL+2 +WR+1 | - | WL+2 +WR+1 | - | WL+2 +WR+1 | - | nCK |
| Timing of REF command to Power Down entry | tREFPDEN | 1 | - | 1 | - | 1 | - | |
| Timing of MRS command to Power Down entry | tMRSPDEN | tMOD(min) | - | tMOD(min) | - | tMOD(min) | - | |



Product Specifications

PART NO.:

VL47B2863A-F8SE

REV: 1.0

AC TIMING PARAMETERS & SPECIFICATIONS

| Parameter | Symbol | K0 (DDR3-1600) | | K9 (DDR3-1333) | | F8 (DDR3-1066) | | Unit |
|--|----------|-------------------|-----|-------------------|-----|-------------------|-----|----------|
| | | MIN | MAX | MIN | MAX | MIN | MAX | |
| ODT Timing | | | | | | | | |
| ODT high time without write command or with write command and BC4 | ODTH4 | 4 | - | 4 | - | 4 | - | nCK |
| ODT high time with Write command and BL8 | ODTH8 | 6 | - | 6 | - | 6 | - | nCK |
| Asynchronous RTT turn-on delay (Power-Down with DLL frozen) | tAONPD | 2 | 8.5 | 2 | 8.5 | 2 | 8.5 | ns |
| Asynchronous RTT turn-off delay (Power-Down with DLL frozen) | tAOFPD | 2 | 8.5 | 2 | 8.5 | 2 | 8.5 | ns |
| ODT turn-on | tAON | -225 | 225 | -250 | 250 | -300 | 300 | ps |
| RTT_NOM and RTT_WR turn-off time from ODTL off reference | tAOF | 0.3 | 0.7 | 0.3 | 0.7 | 0.3 | 0.7 | tCK(avg) |
| RTT dynamic change skew | tADC | 0.3 | 0.7 | 0.3 | 0.7 | 0.3 | 0.7 | tCK(avg) |
| Write Leveling Timing | | | | | | | | |
| First DQS pulse rising edge after tDQSS margining mode is programmed | tWLMRD | 40 | - | 40 | - | 40 | - | tCK |
| DQS/DQS delay after tDQS margining mode is programmed | tWLDQSEN | 25 | - | 25 | - | 25 | - | tCK |
| Setup time for tDQSS latch | tWLS | 165 | - | 195 | - | 245 | - | ps |
| Hold time for tDQSS latch | tWLH | 165 | - | 195 | - | 245 | - | ps |
| Write leveling output delay | tWLO | 0 | 7.5 | 0 | 9 | 0 | 9 | ns |
| Write leveling output error | tWLOE | 0 | 2 | 0 | 2 | 0 | 2 | ns |

| Product Specifications | | |
|------------------------|-----------------|----------|
| PART NO.: | VL47B2863A-F8SE | REV: 1.0 |

Package Dimensions

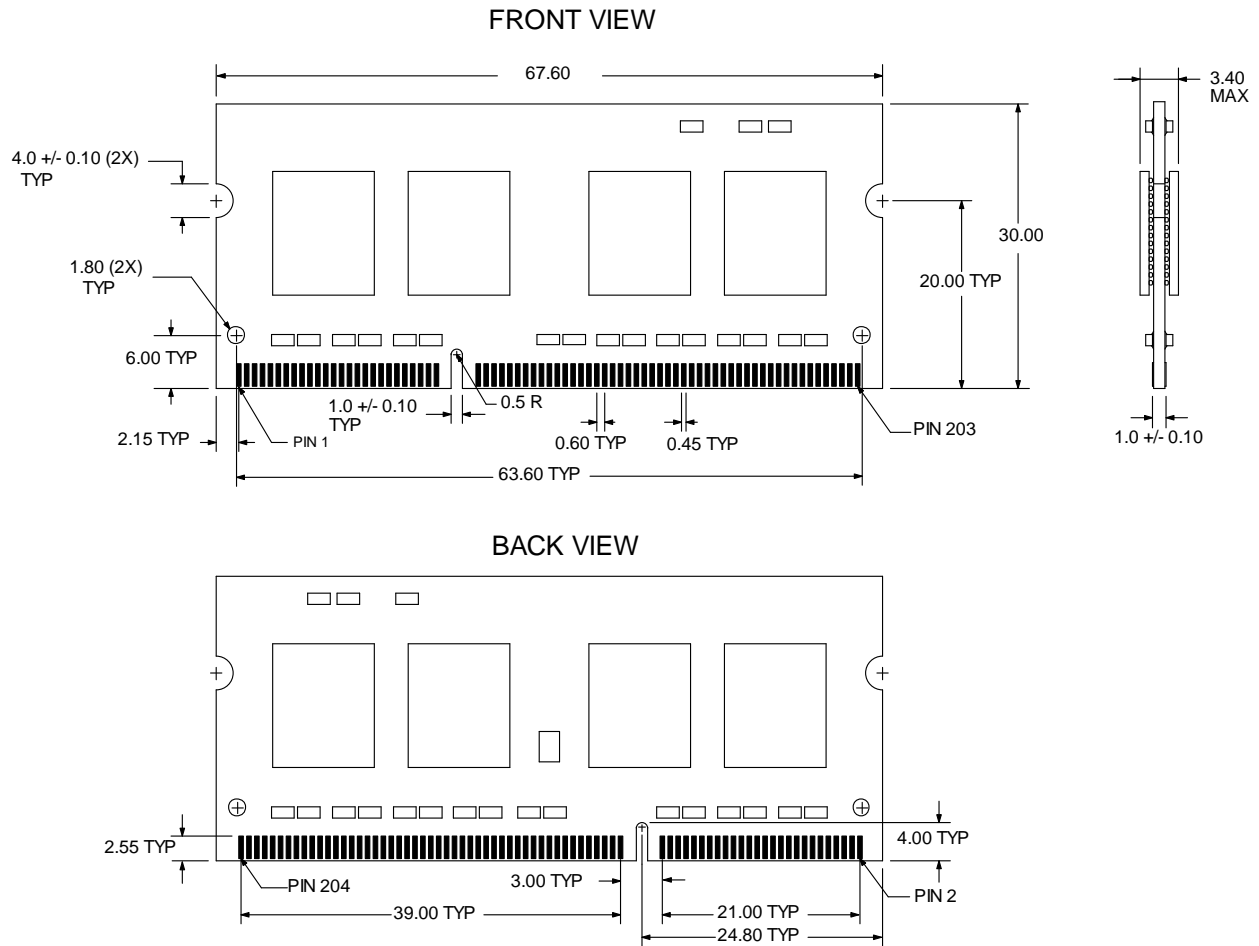

Note: 1. All dimensions are in millimeters with tolerance +/- 0.15mm unless otherwise specified.
 2. The dimensional diagram is for reference only.



| Product Specifications | | |
|-------------------------------|------------------------|-----------------|
| PART NO.: | VL47B2863A-F8SE | REV: 1.0 |

Revision History:

| Date | Rev. | Page | Changes |
|-------------|-------------|-------------|----------------|
| 10/24/2012 | 1.0 | All | Spec release |
| | | | |
| | | | |