

THIS DRAWING IS UNPUBLISHED. RELEASED FOR PUBLICATION 2006
 © COPYRIGHT 2006 ALL RIGHTS RESERVED.

| LOC | | DIST | | REVISIONS | | | DATE | DWN | APVD |
|-----|-----|---------------------------|--|-----------|----------|----|------|-----|------|
| P | LTR | DESCRIPTION | | | | | | | |
| | CI | REVISED PER ECO-11-005030 | | | 2APR2011 | RK | HMR | | |

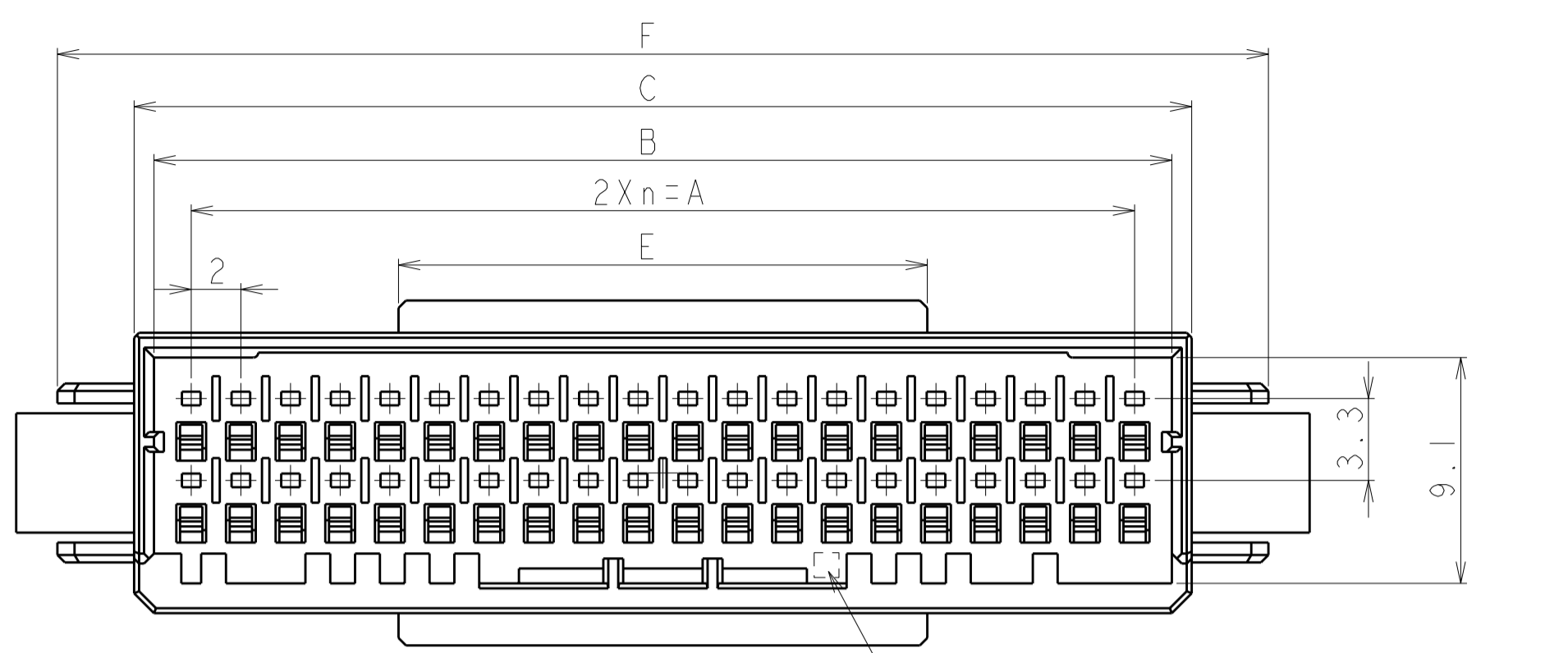

CAVITY MARK
(ALPHABET: CAPITAL LETTER)

40POS(X-KEY): 1-1903128-0

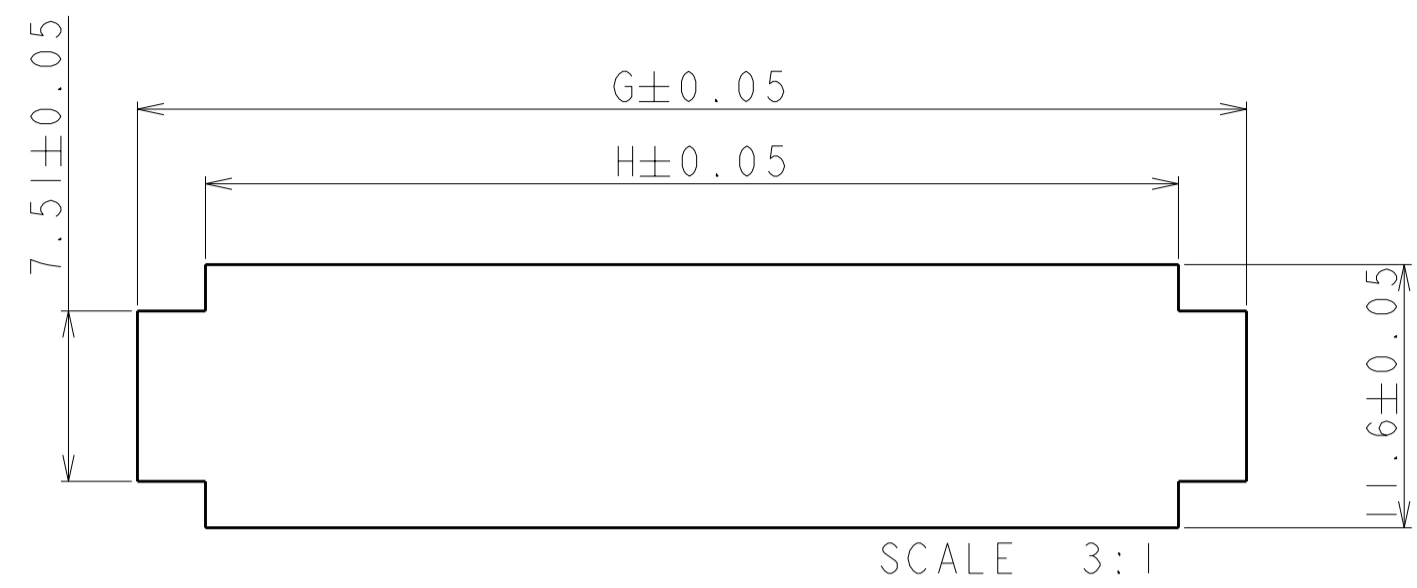

RECOMMENDED PANEL LAYOUT
(APPLICABLE PANEL THICKNESS : 0.8, 1.0, 1.6, 2.0)

パネル加工推奨寸法図
(適用パネル厚 : 0.8, 1.0, 1.6, 2.0)

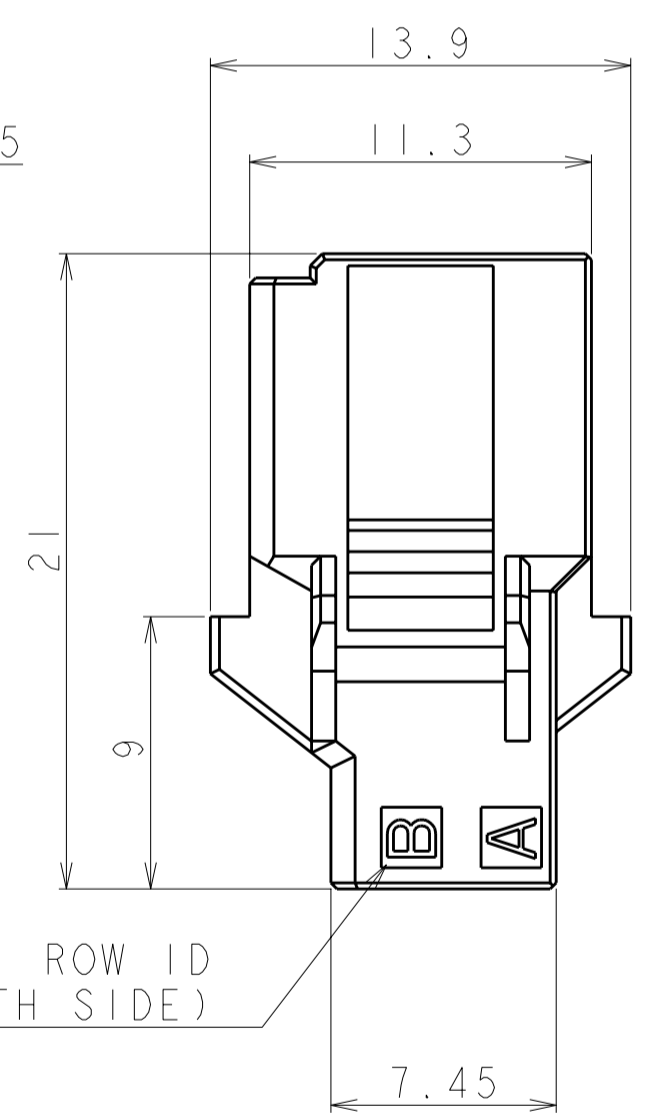
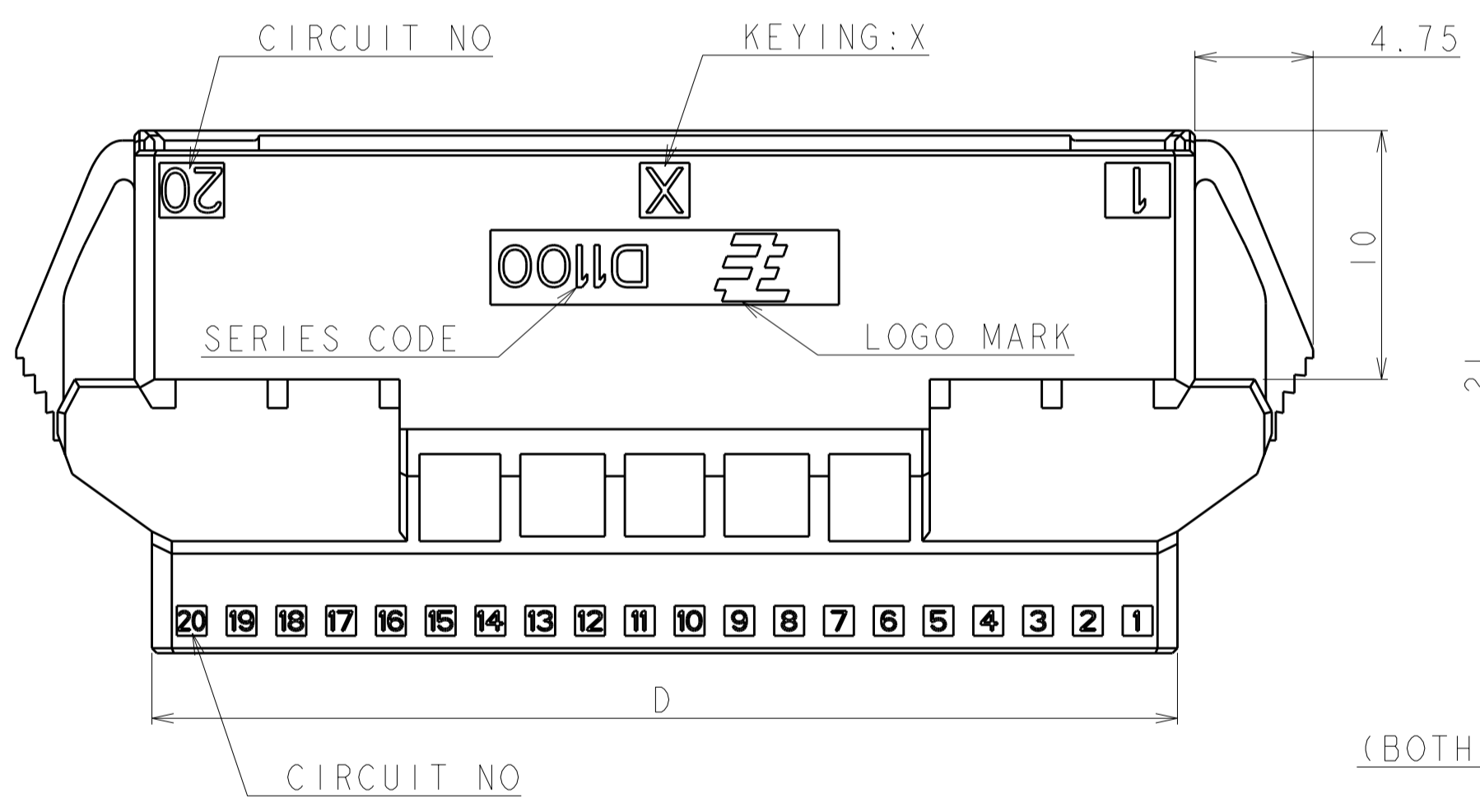

1. MATERIAL: GLASS FILLED THERMO PLASTIC POLYESTER(94V-0), COLOR: BLACK
 2. THE SHAPE, SIZE AND POSITION OF THE CHARACTER SHOW THE OUTLINE. THEY DON'T SHOW DETAILS.

1. 材料: ガラス入り熱可塑性ポリエステル樹脂(94V-0), 色: 黒
 2. 文字の形状、大きさ、および位置については、大略を示すものであり、詳細を示すものではありません。

AS SHOWN 40POS : 1-1903128-0

| 40 | X | 19 | 38.0 | 41.0 | 42.6 | 41.2 | 21.3 | 48.78 | 48.9 | 42.9 | 1-1903128-0 |
|-----|-----|----|------|------|------|------|------|-------|------|------|-------------|
| 34 | X | 16 | 32.0 | 35.0 | 36.6 | 35.2 | 18.3 | 42.78 | 42.9 | 36.9 | 1-1903128-7 |
| 32 | X | 15 | 30.0 | 33.0 | 34.6 | 33.2 | 17.3 | 40.78 | 40.9 | 34.9 | 1-1903128-6 |
| 28 | X | 13 | 26.0 | 29.0 | 30.6 | 29.2 | 15.3 | 36.78 | 36.9 | 30.9 | 1-1903128-4 |
| 26 | X | 12 | 24.0 | 27.0 | 28.6 | 27.2 | 14.3 | 34.78 | 34.9 | 28.9 | 1-1903128-3 |
| 22 | X | 10 | 20.0 | 23.0 | 24.6 | 23.2 | 13.2 | 30.78 | 30.9 | 24.9 | 1-1903128-1 |
| POS | KEY | n | A | B | C | D | E | F | G | H | PART NO |

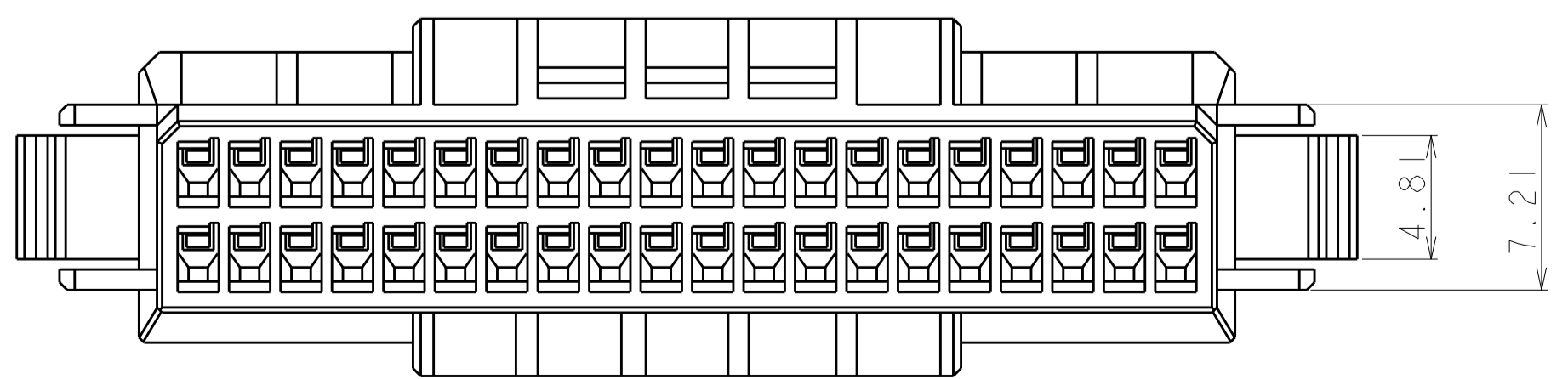

THIS DRAWING IS A CONTROLLED DOCUMENT.

| | | | |
|----------------------------|--|---|--|
| DIMENSIONS: 単位: 概 mm | TOLERANCES UNLESS OTHERWISE SPECIFIED: 一般公差 ±0.3, ±3° 0-PLC ± 1-PLC ± 2-PLC ± 3-PLC ± 4-PLC ± ANGLES ± FINISH 仕上 | DWN M. MAEBASHI 17APR2006 CHK T. KUDO 17APR2006 APVD D. MITSUGI 17APR2006 PRODUCT SPEC 108-78268, 78298 APPLICATION SPEC 114-5377 WEIGHT | NAME DYNAMIC D1100D 2.0mm PITCH TAB HSG, PANEL MOUNT TYPE 22-40 POS |
| MATERIAL 材料 | | SIZE A2 CAGE CODE 00779 DRAWING NO. C-1903128 RESTRICTED TO | SCALE 4:1 SHEET 1 OF 3 REV. CI |

CUSTOMER DRAWING

THIS DRAWING IS UNPUBLISHED. RELEASED FOR PUBLICATION 2006
 © COPYRIGHT 2006 ALL RIGHTS RESERVED.

| | | | | |
|-----|------|-----------|-------------|------|
| LOC | DIST | REVISIONS | | |
| J | | P | LTR | DATE |
| | | - | SEE SHEET 1 | - |
| | | | DESCRIPTION | DWN |
| | | | | APVD |

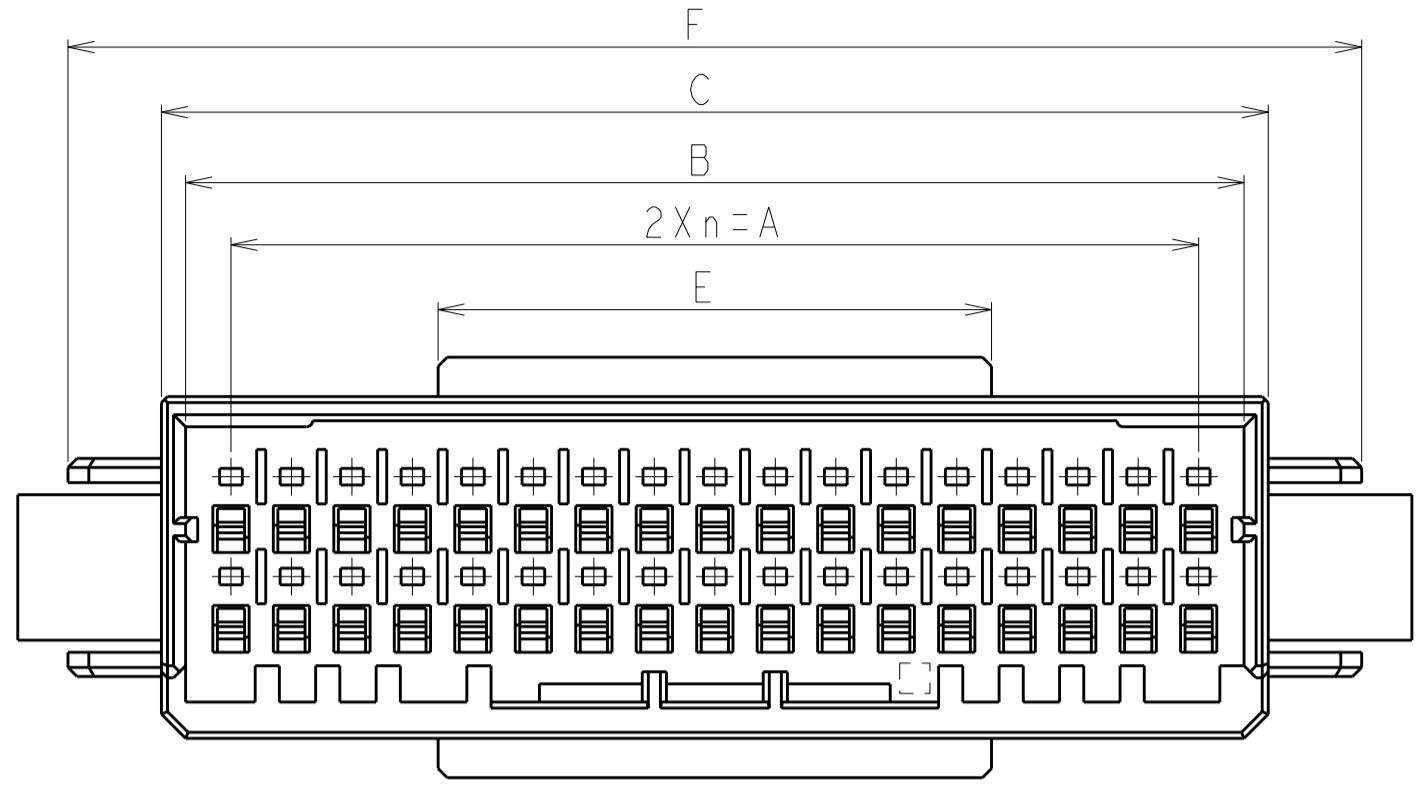

34POS(X-KEY):1-1903128-7

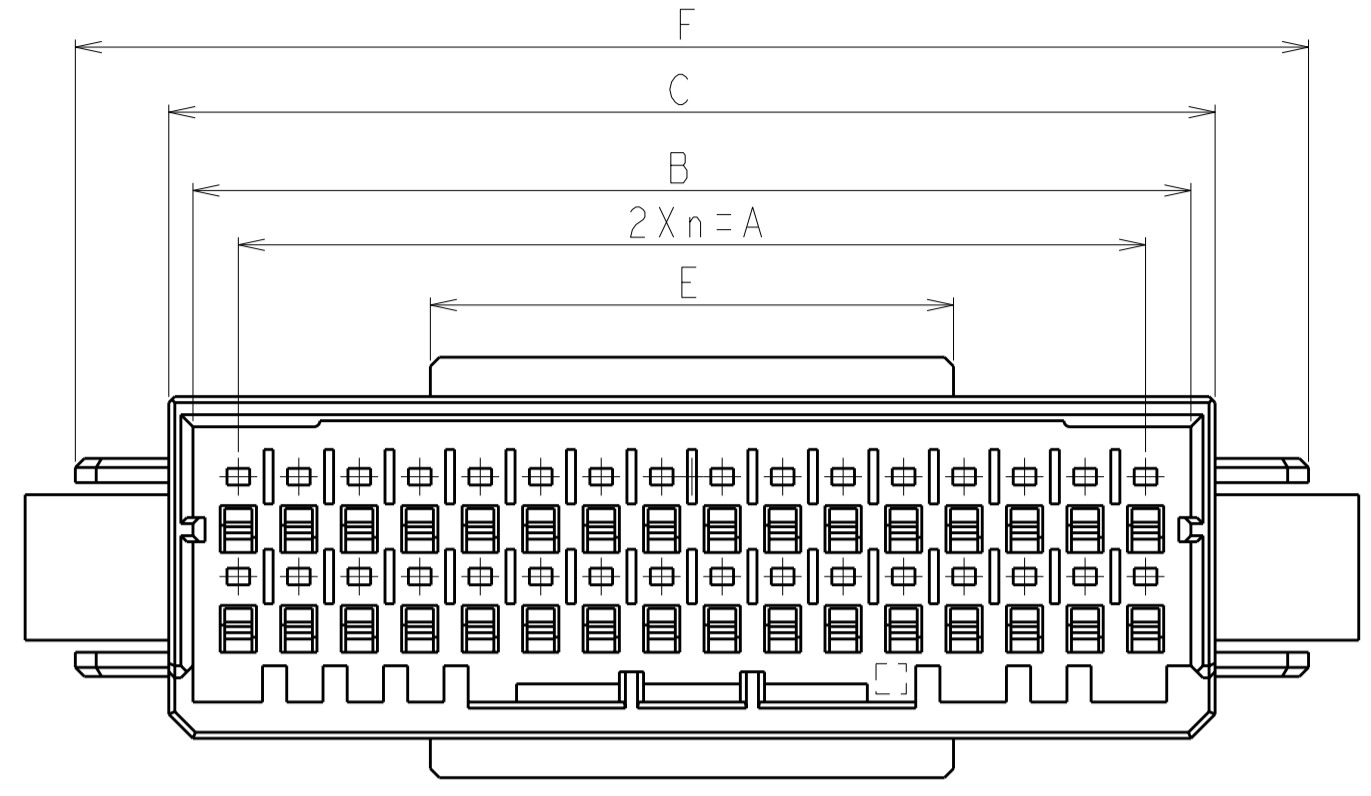

32POS(X-KEY):1-1903128-6

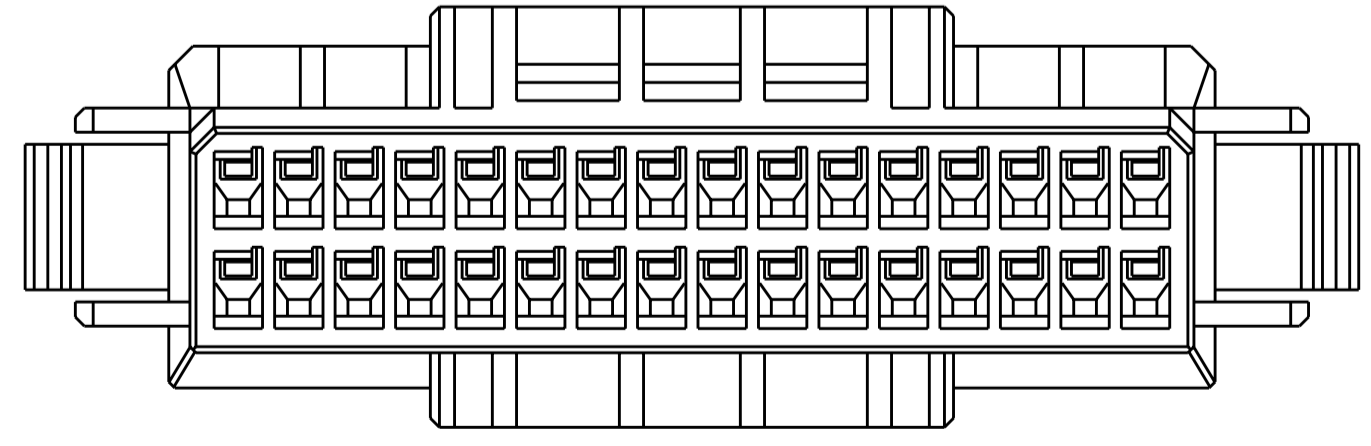
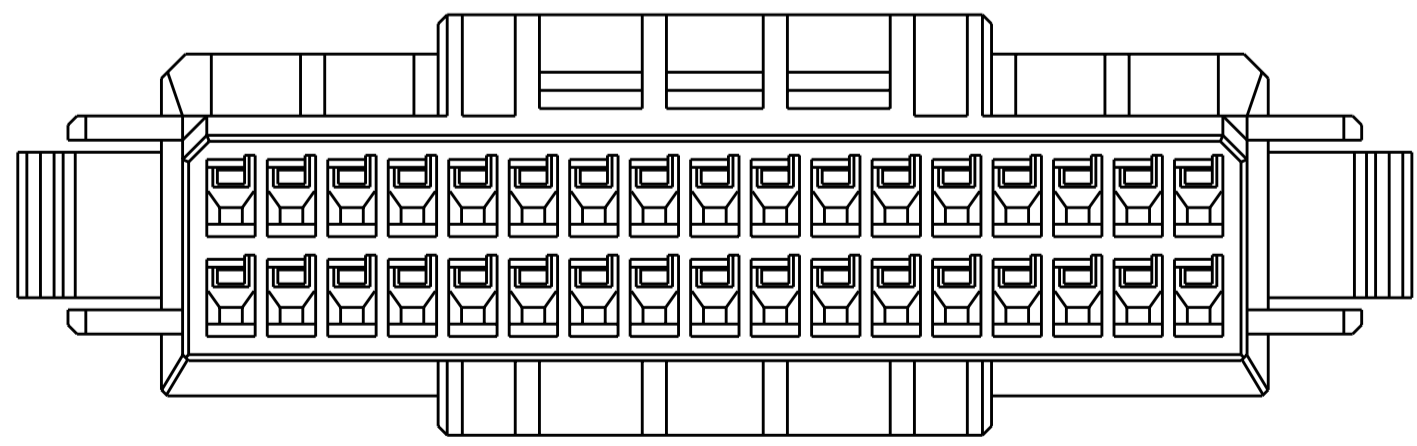
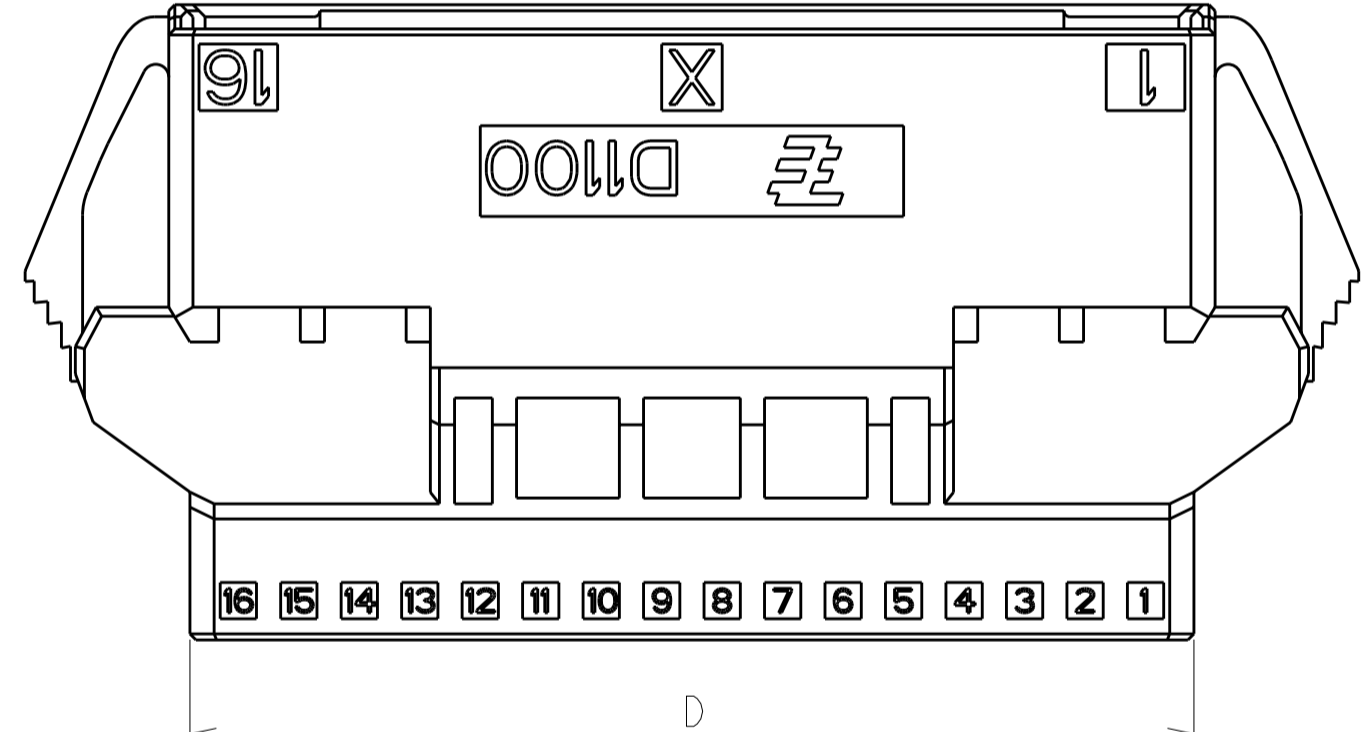
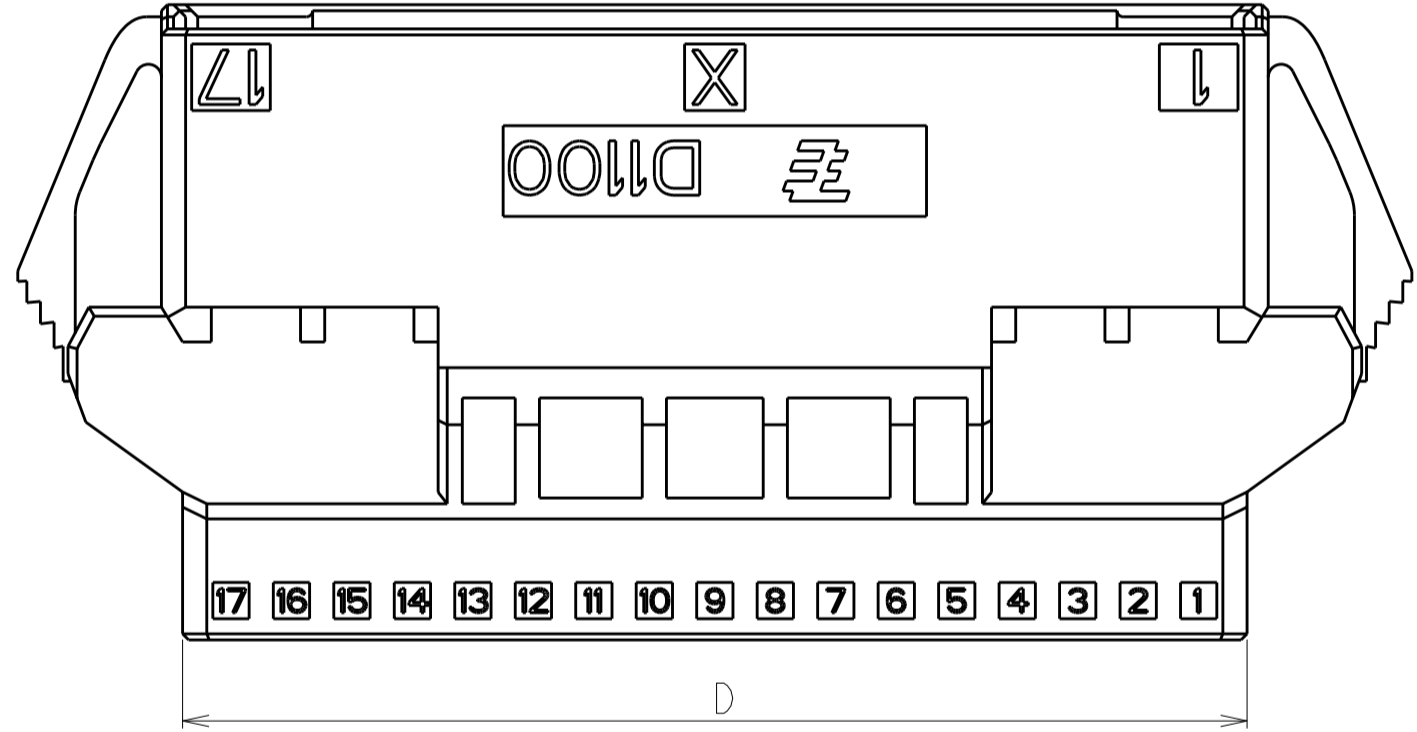

| | | | |
|--|--|--|--|
| THIS DRAWING IS A CONTROLLED DOCUMENT. | | DWN M. MAEBASHI 17APR2006 | TE Connectivity |
| DIMENSIONS: 単位: 概 mm | | CHK T. KUDO 17APR2006 | |
| TOLERANCES UNLESS OTHERWISE SPECIFIED: | | APVD D. MIISUGI 17APR2006 | NAME DYNAMIC D1100D 2.0mm PITCH TAB HSG, PANEL MOUNT TYPE 22-40 POS |
| 一般公差 0 PLC ± 1 PLC ± 2 PLC ± 3 PLC ± 4 PLC ± ANGLES ± FINISH 仕上 | | PRODUCT SPEC 108-78268, 78298 | SIZE A200779 |
| MATERIAL 材料 | | APPLICATION SPEC 取付適用規格 114-5377 | DRAWING NO C-1903128 |
| | | WEIGHT | RESTRICTED TO |
| | | CUSTOMER DRAWING | SCALE 4:1 SHEET 2 OF 3 REV C1 |

THIS DRAWING IS UNPUBLISHED. RELEASED FOR PUBLICATION 2006
 © COPYRIGHT 2006 ALL RIGHTS RESERVED.

| LOC | DIST | REVISIONS | | | | | |
|-----|------|-----------|-----|-------------|------|-----|------|
| J | | P | LTR | DESCRIPTION | DATE | DWN | APVD |
| | | - | | SEE SHEET 1 | | | |

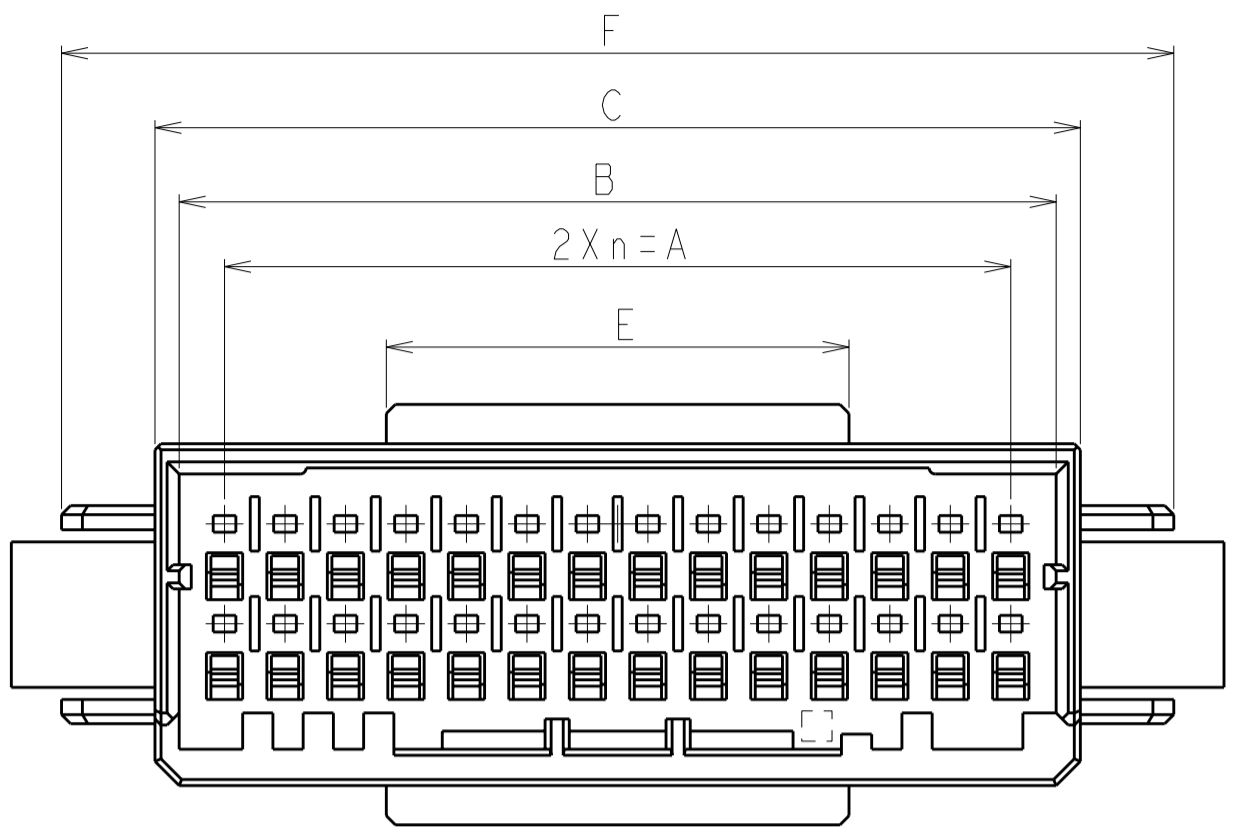

28POS(X-KEY): 1-1903128-4

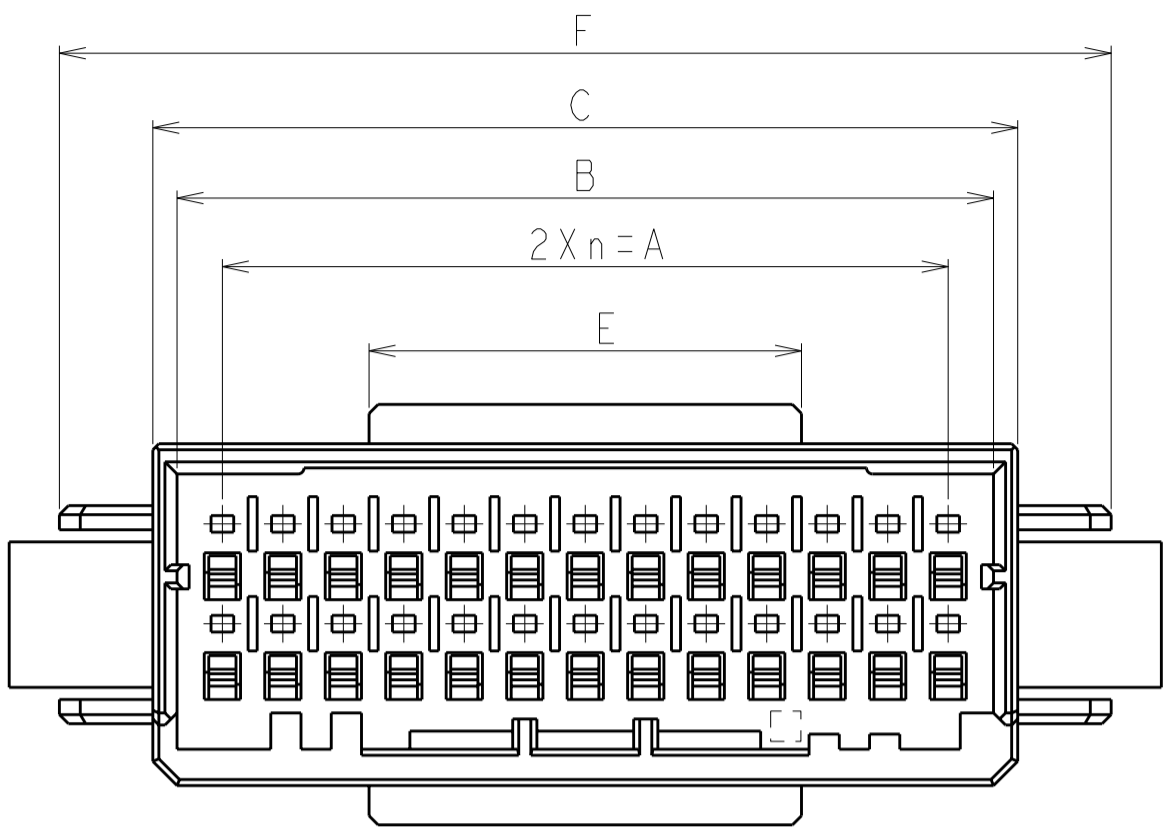

26POS(X-KEY): 1-1903128-3

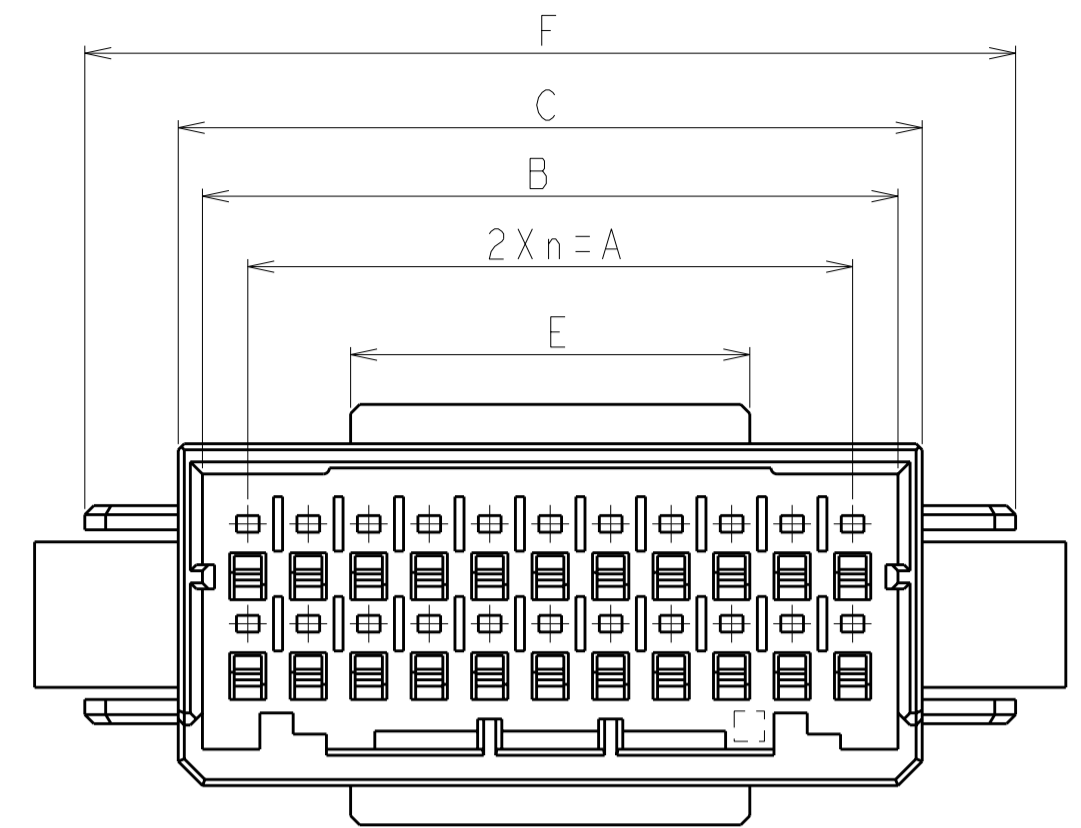

22POS(X-KEY): 1-1903128-1

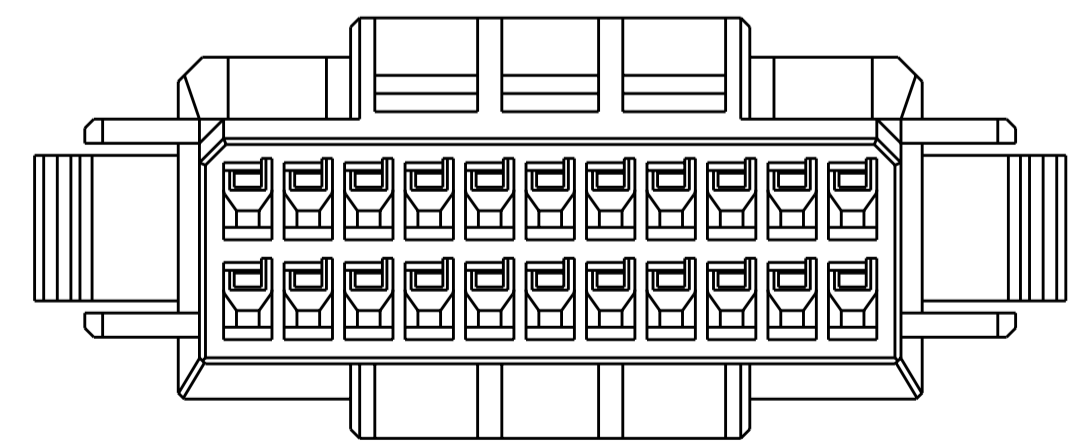
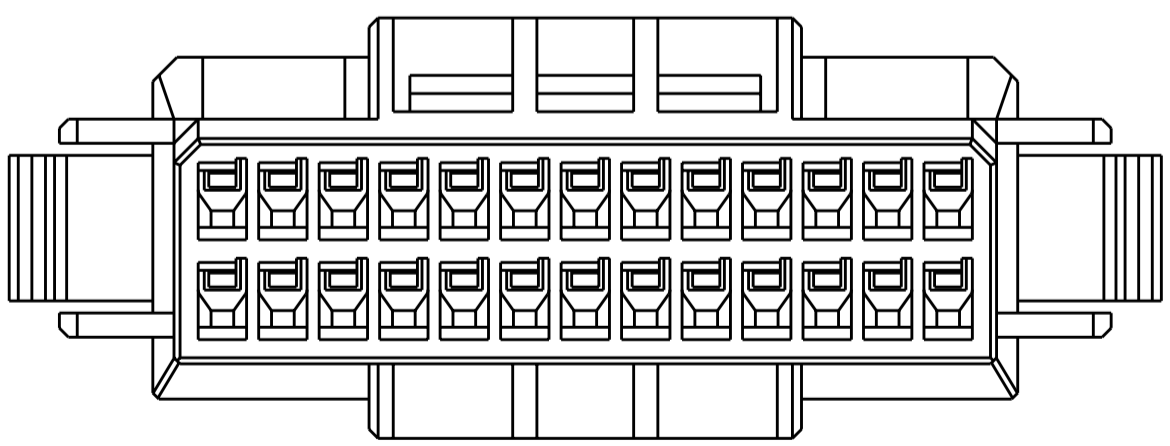
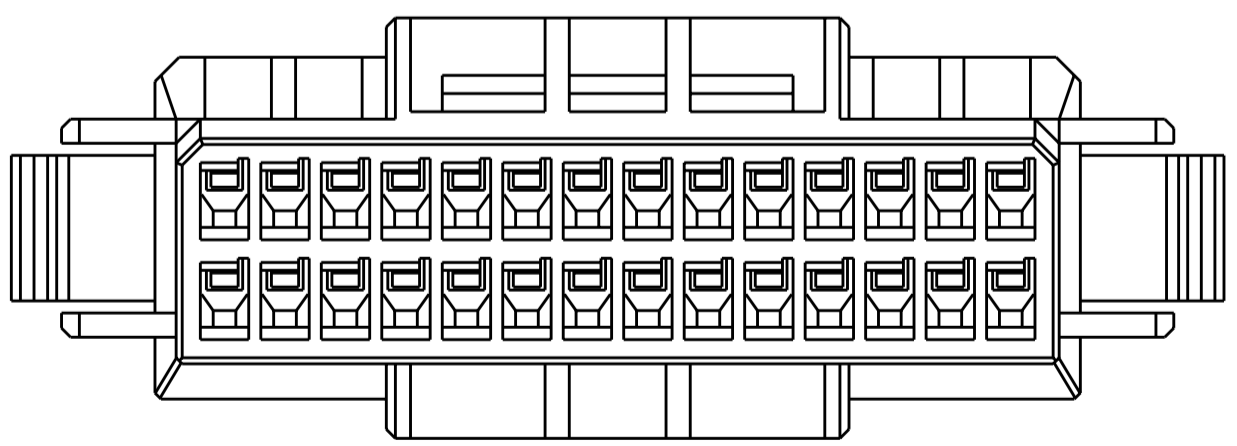
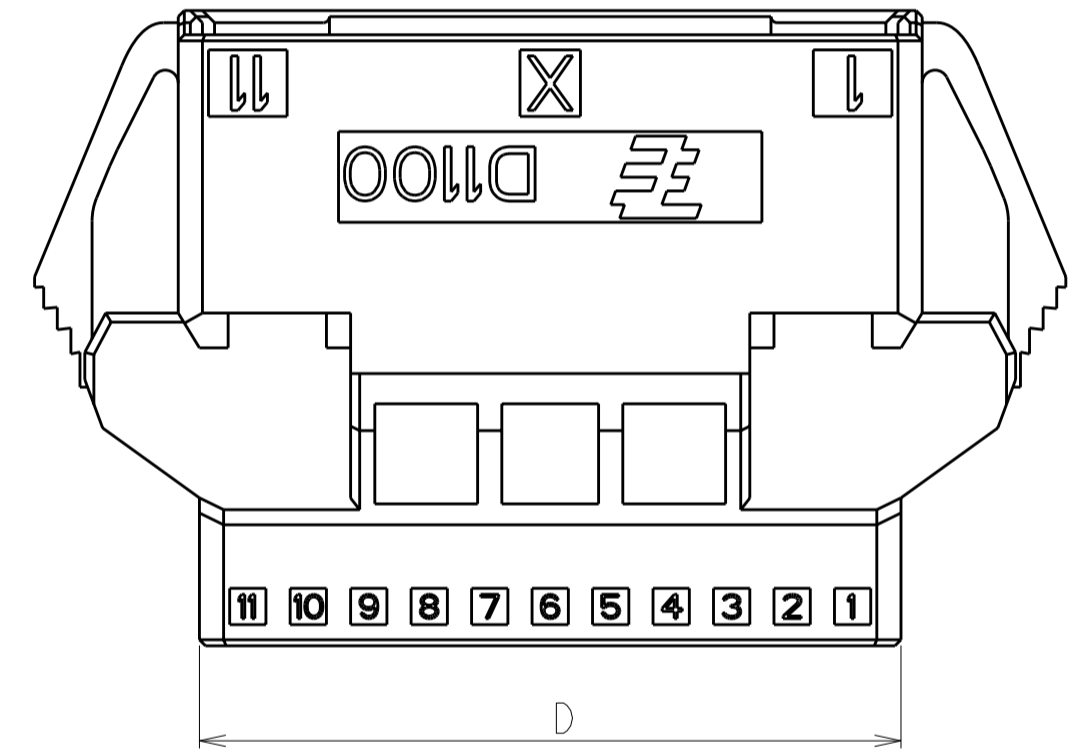
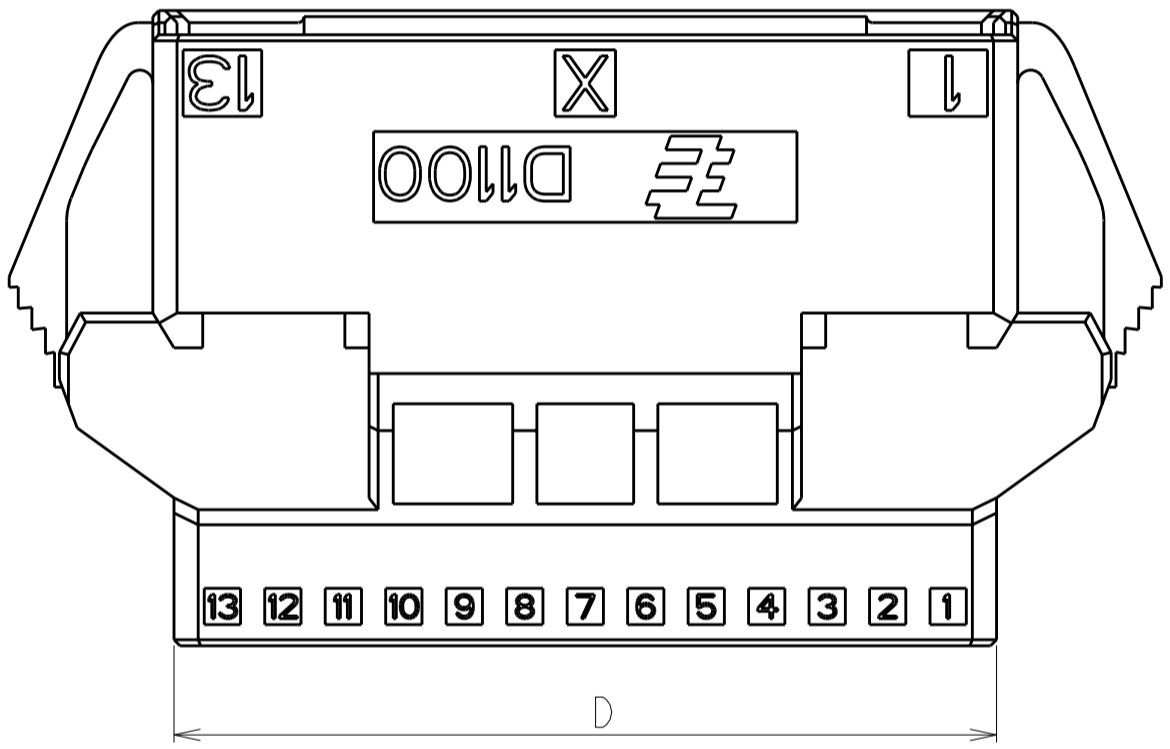
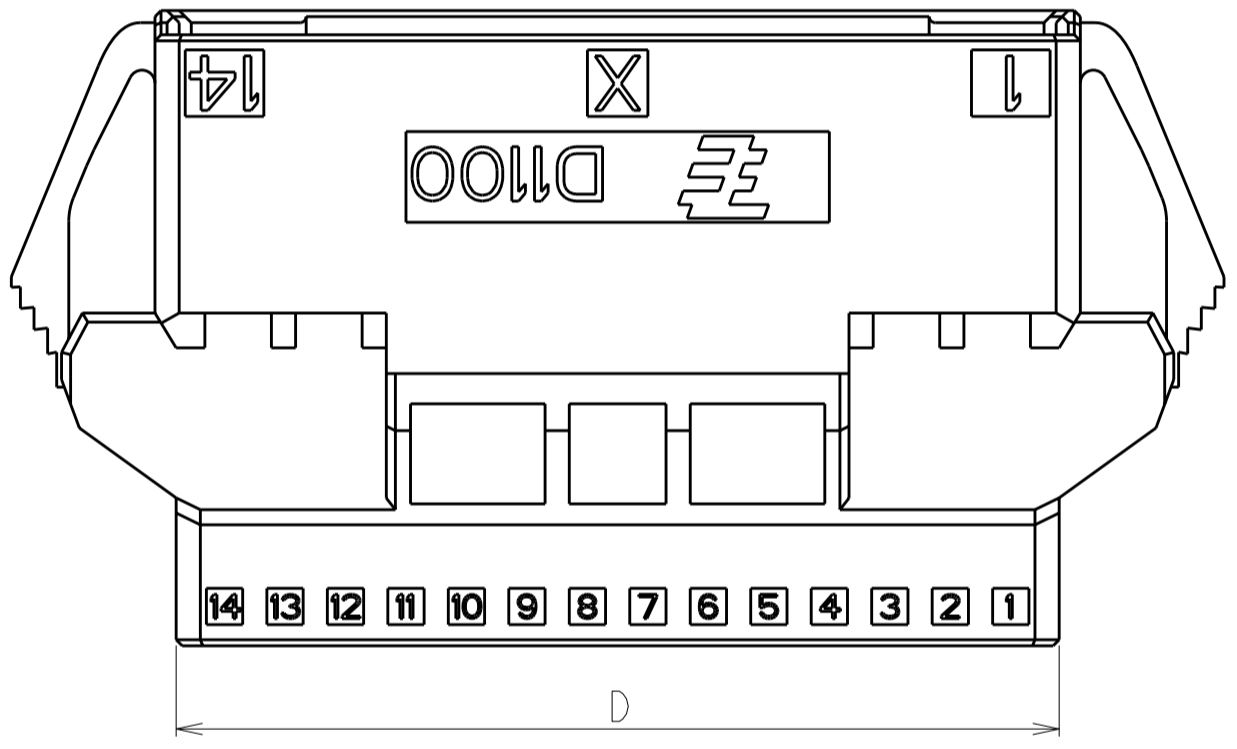

| | | | | |
|---|--|--|---|---------------|
| THIS DRAWING IS A CONTROLLED DOCUMENT. | | DWN M. MAEBASHI 17APR2006 | TE Connectivity DYNAMIC D1100D 2.0mm PITCH TAB HSG, PANEL MOUNT TYPE 22-40 POS | |
| DIMENSIONS: 単位: 概 mm | | CHK T. KUDO 17APR2006 | | |
| TOLERANCES UNLESS OTHERWISE SPECIFIED: 一般公差 0 PLC ± 1 PLC ± 2 PLC ± 3 PLC ± 4 PLC ± ANGLES ± FINISH 仕上 | | APVD D. MITSUGI 17APR2006 | NAME D. MITSUGI | RESTRICTED TO |
| MATERIAL 材料 | | PRODUCT SPEC 製品規格 108-78268, 78298 | APPLICATION SPEC 取付適用規格 114-5377 | SIZE A2 |
| | | WEIGHT | CAGE CODE C-1903128 | SCALE 4:1 |
| | | CUSTOMER DRAWING | DRAWING NO. 1903128 | SHEET 3 OF 3 |