

MAX3710 Evaluation Kit

Evaluates: MAX3710

General Description

The MAX3710 evaluation kit (EV kit) is an assembled demonstration board that provides electrical and optical evaluation of the MAX3710 125Mbps to 2.5Gbps integrated limiting amplifier/burst mode laser driver with dual-loop power control. The controlling software communicates with the EV kit through the USB port of the included card and provides simplified control of all functions of the MAX3710. The EV kit can be fully powered by the USB port, or the user can choose to power the MAX3710 by an external 3.3V supply while the USB port supplies the included HFRD46-1 USB daughter card. The laser connection on the EV board allows attachment of lasers in TO-header packages.

Features

- ◆ **Software Control of the MAX3710**
- ◆ **Power Supplied Through USB or External Connection**
- ◆ **Connection for Lasers in TO Packages**

EV Kit Contents

- ◆ **MAX3710 EV Kit Board**

[Ordering Information](#) appears at end of data sheet.

Component List

DESIGNATION	QTY	DESCRIPTION
C1, C4, C5, C8, C26, C27, C38	7	1000pF ±10% ceramic capacitors (0402)
C2, C3, C6, C7	4	1µF ±10% ceramic capacitors (0402)
C9	1	1pF ±0.25pF ceramic capacitor (0402)
C10	1	6.8pF ±5% ceramic capacitor (0402)
C11	1	22pF ±10% ceramic capacitor (0402)
C12, C13, C28, C30	4	0.01µF ±10% ceramic capacitors (0402)
C14	1	8.2pF ±0.25pF ceramic capacitor (0402)
C15	1	100pF ±5% ceramic capacitor (0402)
C23, C29	2	10µF ±20% ceramic capacitors (0603)
C24, C25, C31, C35, C37	5	0.1µF ±10% ceramic capacitors (0402)
D1, D2, D3	3	Red LEDs
D4, D7	2	Green LEDs
D5	1	Laser, user installed
J1–J8	8	SMA connectors, edge mount
J9, J10	8	SMB connectors, PC mount
J13, J15, TP1–TP6, TP9–TP13, TP17, TP18, TP19, TP21, TP22, TP25	19	Test points
J14	1	Micro-pitch connector
JU19, JU20, JU21	3	2 -in headers, 0.1in centers
JU26	1	3-pin header, 0.1in centers

DESIGNATION	QTY	DESCRIPTION
L1	1	Ferrite bead (0402) Murata BLM15HG102
L3, L5, L6	3	4.7µH ±20% inductors
Q1, Q2, Q3	3	npn transistors
R1, R3, R19	3	4.7kΩ ±5% resistors (0402)
R2, R26, R32, R35–R38, R43–R46	11	Not installed, resistors
R4, R51	2	10.0kΩ ±1% resistors (0402)
R5, R6, R39–R42	6	0Ω resistors (0402)
R7	1	10Ω ±5% resistor (0402)
R8	1	6.04kΩ ±1% resistor (0402)
R9	1	470Ω ±5% resistor (0402)
R10	1	82Ω ±5% resistor (0402)
R12	1	39Ω ±5% resistor (0402)
R14	1	22Ω ±5% resistor (0402)
R15	1	27Ω ±5% resistor (0402)
R17, R50, R52–R55	6	1.00kΩ ±1% resistors (0402)
R24, R25	2	100Ω ±1% resistors (0402)
S1, S2	2	SP3T switches
U1	1	Limiting amplifier/laser driver (24 TQFN-EP*) Maxim MAX3710ETG+
U2	1	EEPROM Atmel
—	1	HFRD46-1 USB interface card
—	1	PCB: MAX3710 EVALUATION BOARD+, REV A

+Denotes a lead(Pb)-free/RoHS-compliant package.

*EP = Exposed pad.

For pricing, delivery, and ordering information, please contact Maxim Direct at 1-888-629-4642, or visit Maxim Integrated's website at www.maximintegrated.com.

MAX3710 Evaluation Kit

Evaluates: MAX3710

Quick Start

Note: In the following section, software-related items are identified by bolding. Text in **bold** refers to items directly from the EV kit software. Text in **bold and underlined** refers to items from the Windows® operating system.

Initial Setup

- 1) Install the MAX3710 EV kit software on a computer by attaching the USB daughter card to the computer using the supplied USB cable. After the USB device has been detected and installed by the operating system, a flash drive becomes available in the **Devices with Removable Storage** section of **My Computer**. Search the flash drive for the MAX3710 EV kit.ZIP file. Copy this file to the desktop or another known folder and unzip the file. Locate the newly created **MAX3710 EV kit** folder and run **setup.EXE**.
 - 2) After installation is complete, follow this path to start the program: **Start** → **All Programs** → **Maxim Integrated Products** → **MAX3710 EV Kit GUI**. The software is a graphical user interface, or GUI, meant to simplify control of the MAX3710.
 - 3) A USB daughter card is included with the MAX3710 EV kit (HFRD46-1). Insert this card into the connector J14.
 - 4) Set jumper on JU26 to the desired power supply option (USB or external supply).
 - 5) If an external power supply is used, set the voltage to 3.3V, the current limit to 300mA, and connect the supply to the board.
 - 6) Connect the computer to the USB daughter card with a USB cable (A-male to Mini-B-Male). Several LEDs should illuminate indicating that the USB source is powered. Click the **Initialize** button in the software to initiate communication to the EVkit. When communication is established the **Status** indicator on the GUI turns green.
- #### Transmitter Evaluation
- For transmitter evaluation follow these steps:
- 1) Solder a laser to connection D5. See [Figure 1](#) for more information about the laser connection.
 - 2) Determine whether to connect a high-speed source to the BEN inputs (J5 and J6), or whether to manually control the BEN input.
 - a) If using the input SMA connectors, the default EV kit components are set up for a CML or LVDS source. If you have a different source or would like operate the EV kit single-ended, refer to Figure 3 in the MAX3710 IC data sheet for information on how to configure the BEN input.
 - b) If you choose manual control, remove the differential input resistor at R25 and add a 10kΩ resistor at R26. Doing so allows direct control of the BEN input by switch S2, or by the software GUI if the switch S2 is set to the mid position.
 - 3) Connect a 50Ω source to TIN+ and TIN- (J7 and J8). Set the source differential amplitude to 500mV_{p-p}. Set the source common-mode voltage to 2V or use external DC-blocks.
 - 4) If BEN is to be operated through the SMA connectors, connect a 50Ω source to BEN+ and BEN- (J5 and J6). Set the source differential amplitude to 500mV_{p-p} and the common-mode voltage to 2V. See Figure 1 of the MAX3710 IC data sheet for more information on the acceptable differential and common-mode voltages at BEN.
 - 5) Connect the output from the TOSA to an optical receiver (optical-to-electrical converter or optical input head on an oscilloscope).
 - 6) All controls of the MAX3710 are available in the software. Fault and warning indicators are displayed on the right side of the GUI window. When a hard fault has occurred the part goes into latched shutdown. The source of the fault should be removed and the **DISABLE** button should be toggled to reset the part.
 - 7) The registers contain a default setting and can be read using the **Block Read All** button. For detailed register functions, refer to the MAX3710 IC data sheet.
 - 8) Note that the GUI software automatically sets the MAX3710 into “setup mode” before writing to a register. If the **Enable Block Write** checkbox is checked, multiple writes can be buffered by the GUI and written all at once when the **TX Block Write** or **Block Write All** button is clicked.

Windows is a registered trademark and registered service mark of Microsoft Corporation.

MAX3710 Evaluation Kit

Evaluates: MAX3710

Receiver Evaluation

For receiver evaluation follow these steps:

- 1) Connect a 50Ω source to RIN+ and RIN- (J3 and J4).
- 2) Connect the outputs ROUT+ and ROUT- (J1 and J2) to 50Ω oscilloscope inputs.
- 3) The receiver controls are located in the **RECEIVER** section of the GUI.
- 4) Note that the GUI software automatically sets the MAX3710 into “setup mode” before writing to a register. If the **Enable Block Write** checkbox is checked, multiple writes can be buffered by the GUI and written all at once when the **RX Block Write** or **Block Write All** button is clicked.

Graphical User Interface (GUI)

The GUI consists of four main sections: receiver, transmitter, dual power control, and block read and write ([Figure 2](#)).

Receiver

All the controls for the **RECEIVER** portion of the MAX3710 are included in this block. The SET_CML and SET_LOS registers are written to by inserting the desired decimal value for the register in the appropriate box and clicking the **LOAD** button.

Transmitter

The **TRANSMITTER** block allows control of transmitter's general settings. Clicking the **TX Read** button reads all the registers shown in the **TRANSMITTER** section.

Dual Power Control

The **Dual Power Control** block allows adjustment and monitoring of the transmitter's dual power-control loops. A subblock in this section, **DATA REPORTING**, uses the MAX3710's registers to calculate the apparent average power (**NAPC**), the apparent extinction ratio (**IR**), and the average MD current (**IMDAVG**). The MD0REG and MD1REG values shown in the GUI are 8bit.8bit so they range from 0 to 255 with 0.0039 granularity.

Block Read and Write

The **Block Read and Write** section allows the user to read/write to more than one register at a time. Clicking any of the **Block Read** buttons will cause the GUI to execute a block read of the appropriate group of registers. By clicking the **Enable Block Write** box, the user will be able to change multiple registers without a write being executed each time. The GUI buffers the commands and executes them in a single write command once the appropriate **Block Write** button has been pressed. Note that if **Block Write** is not selected, individual bits will be written any time a check box is checked or unchecked, or a field value is changed.

MAX3710 Evaluation Kit

Evaluates: MAX3710

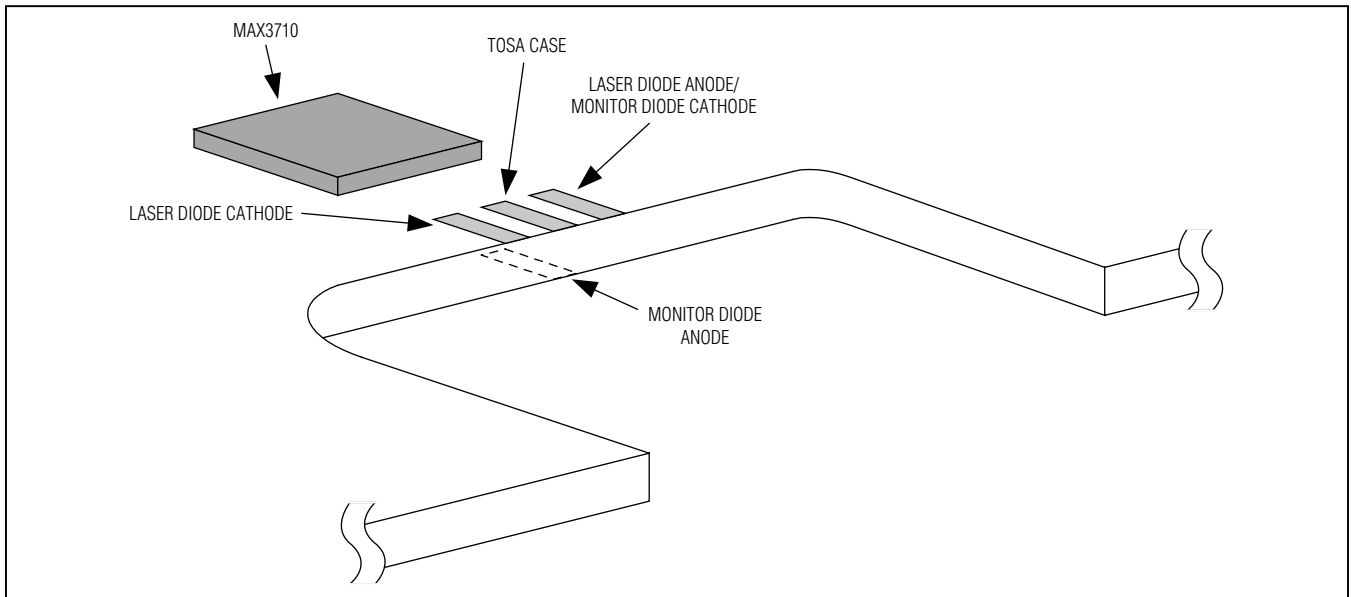

Figure 1. TOSA Connection

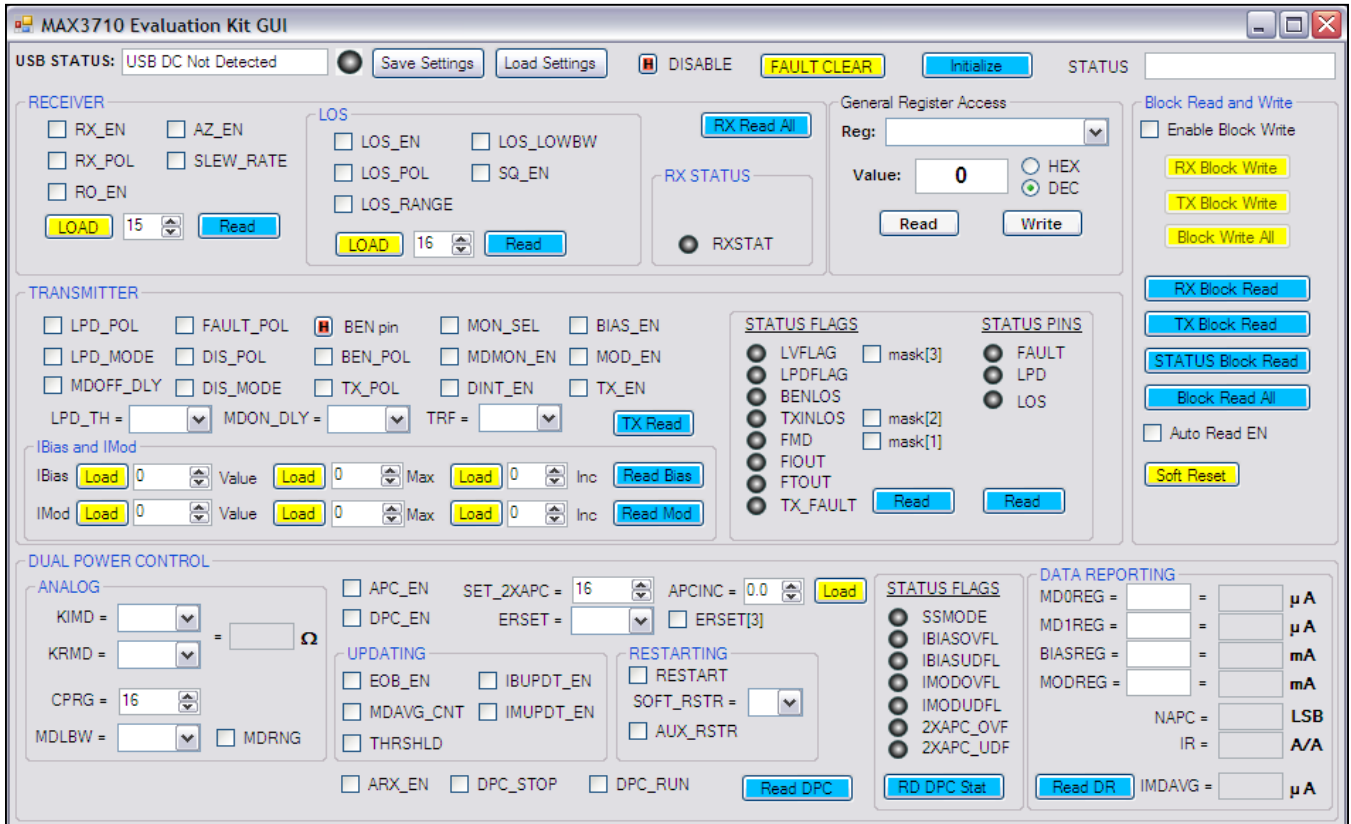

Figure 2. MAX3710 EV Kit Software

MAX3710 Evaluation Kit

Evaluates: MAX3710

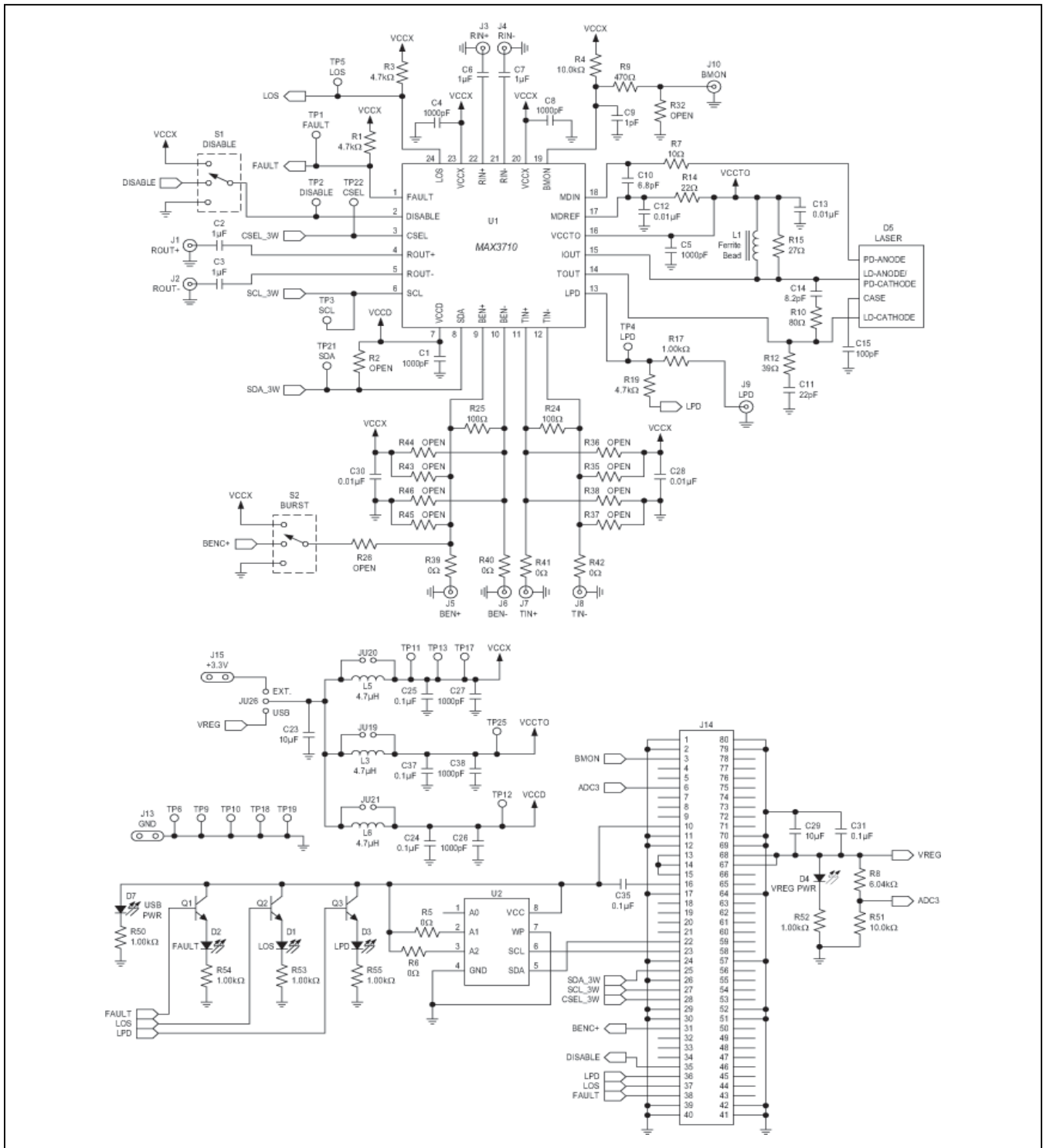

Figure 3. MAX3710 EV Kit Schematic

MAX3710 Evaluation Kit

Evaluates: MAX3710

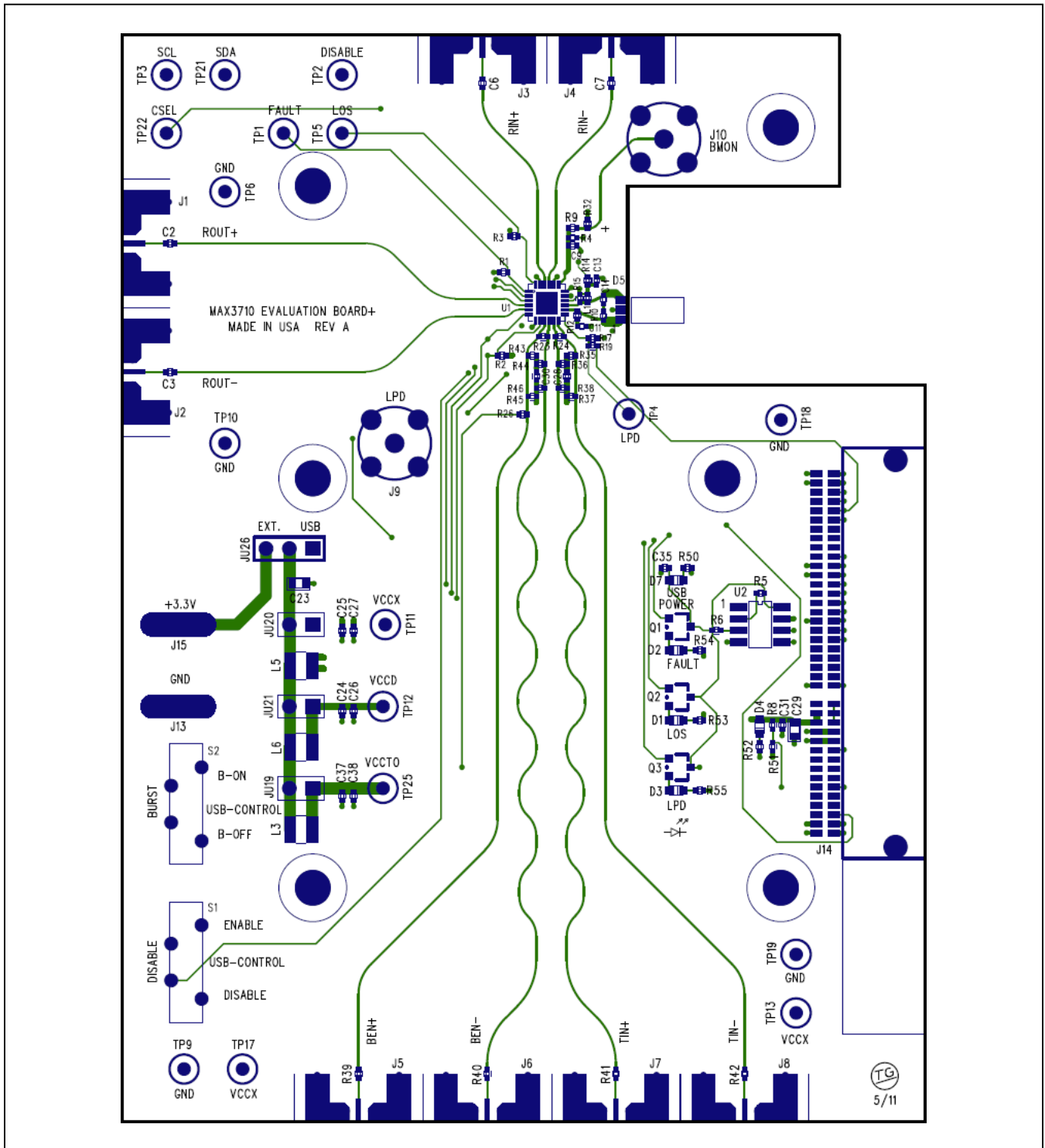

Figure 4. MAX3710 EV Kit Component Placement Guide—Component Side

MAX3710 Evaluation Kit

Evaluates: MAX3710

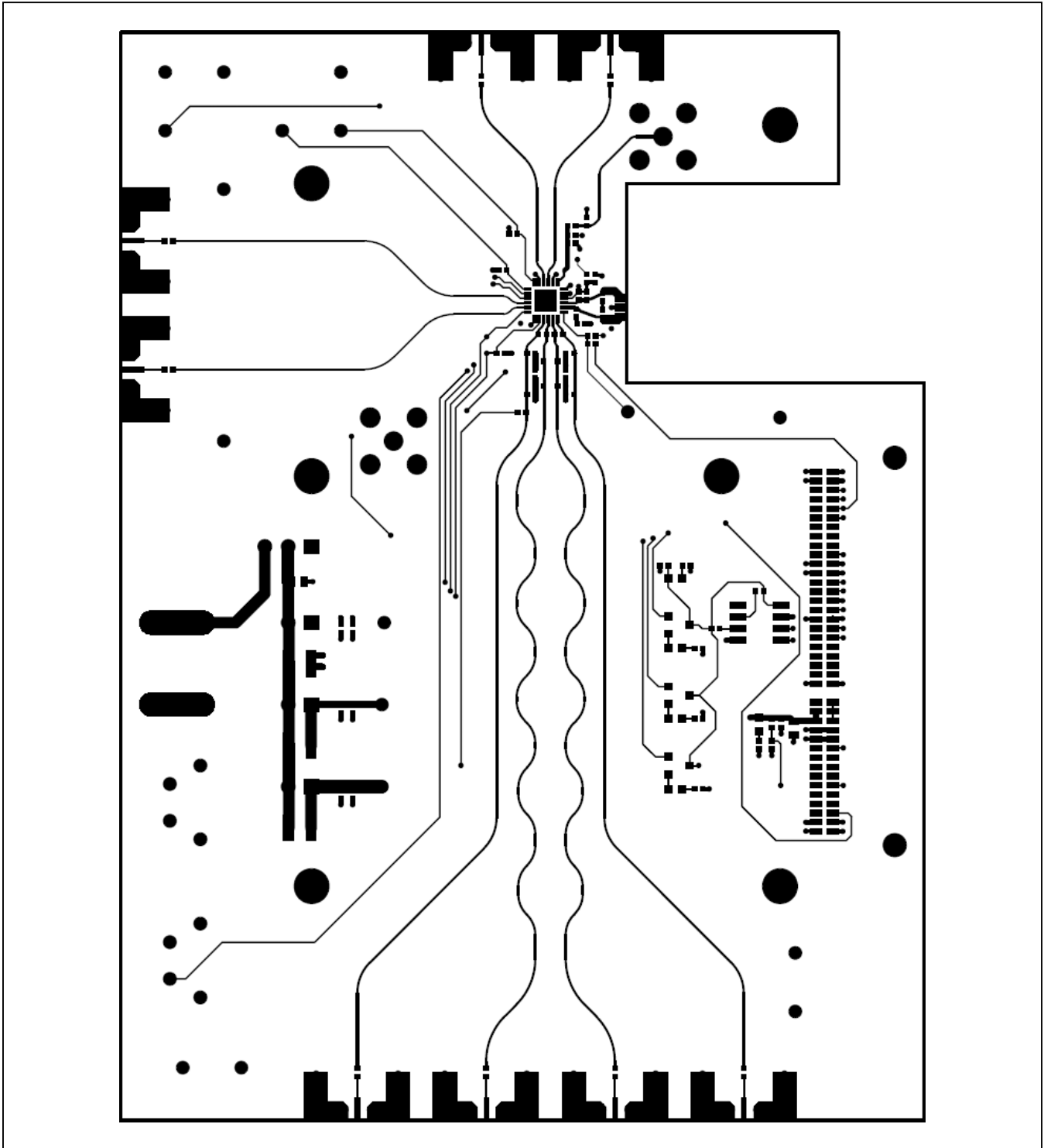

Figure 5. MAX3710 EV Kit PCB Layout—Top Side

MAX3710 Evaluation Kit

Evaluates: MAX3710

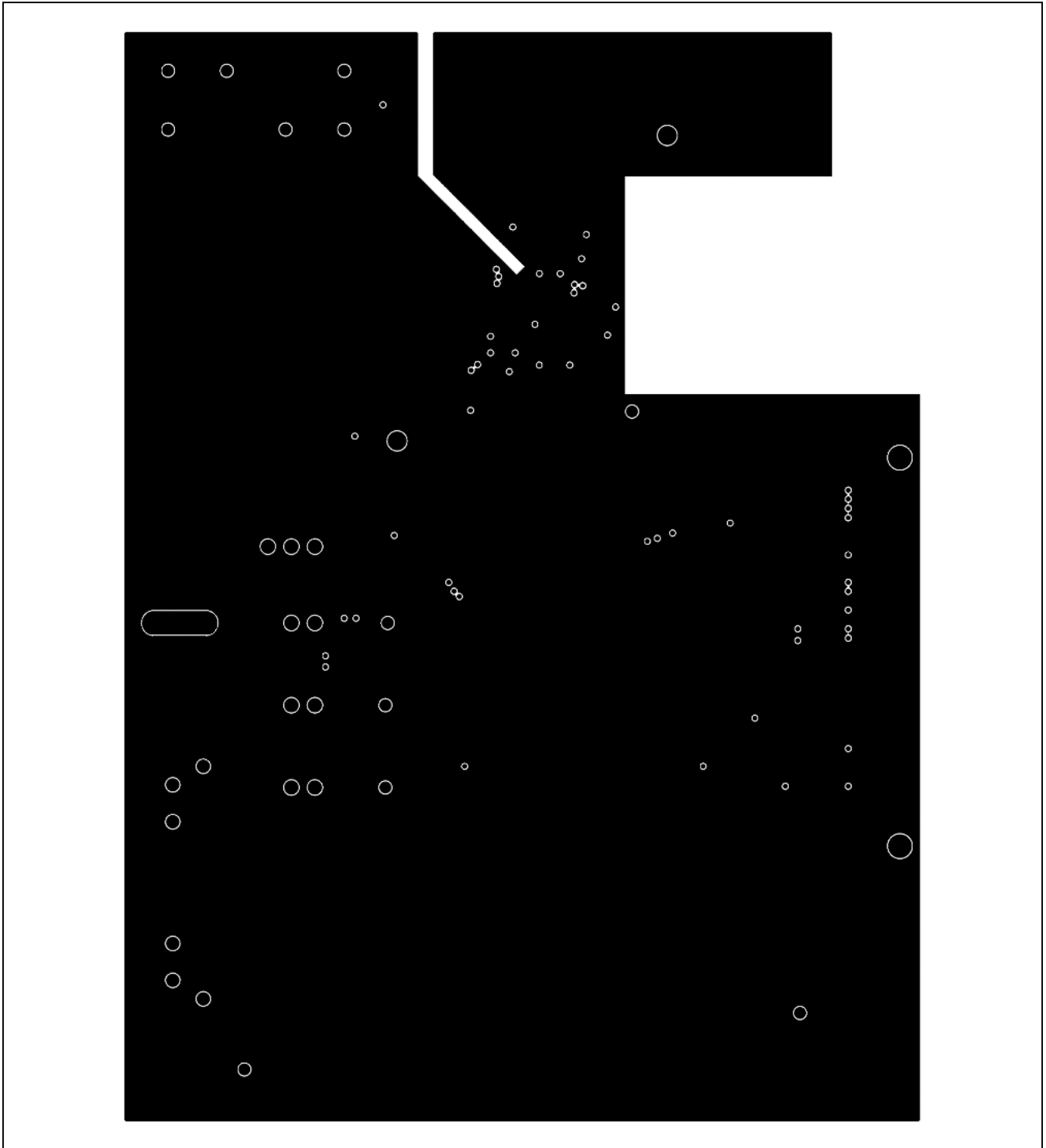

Figure 6. MAX3710 EV Kit PCB Layout—Ground Plane

MAX3710 Evaluation Kit

Evaluates: MAX3710

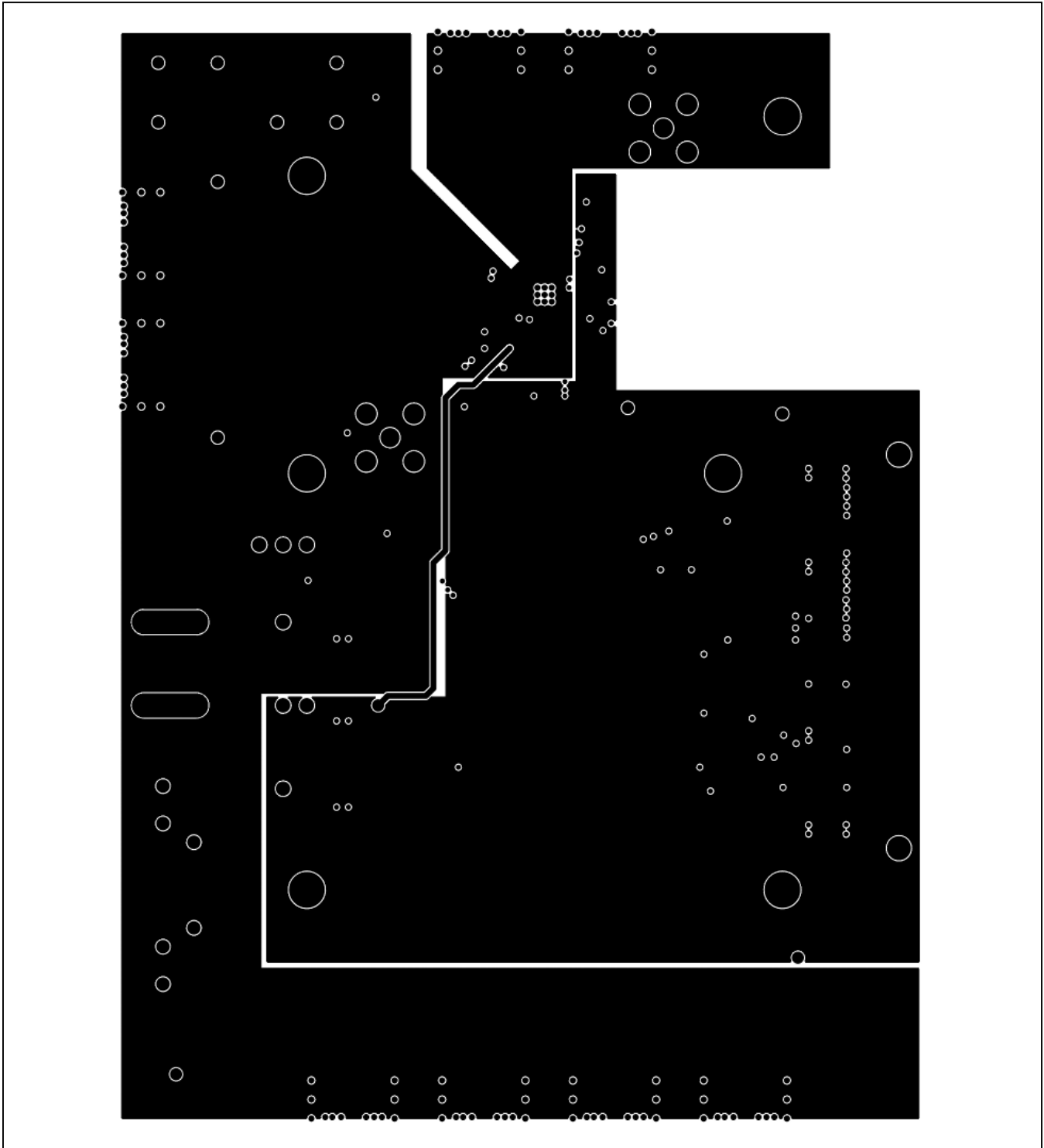

Figure 7. MAX3710 EV Kit PCB Layout—Power Plane

MAX3710 Evaluation Kit

Evaluates: MAX3710

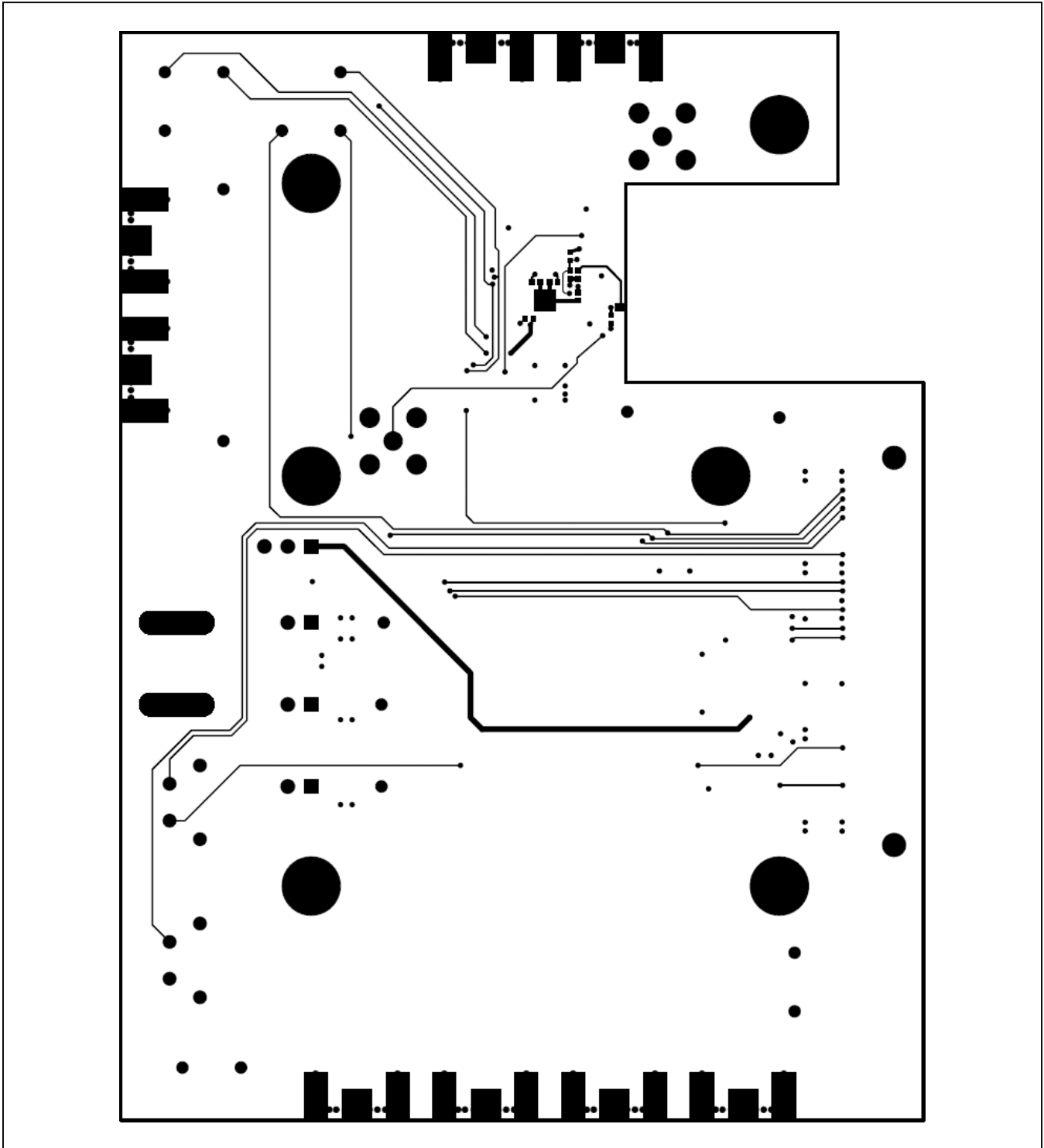

Figure 8. MAX3710 EV Kit PCB Layout—Solder Side

MAX3710 Evaluation Kit

Evaluates: MAX3710

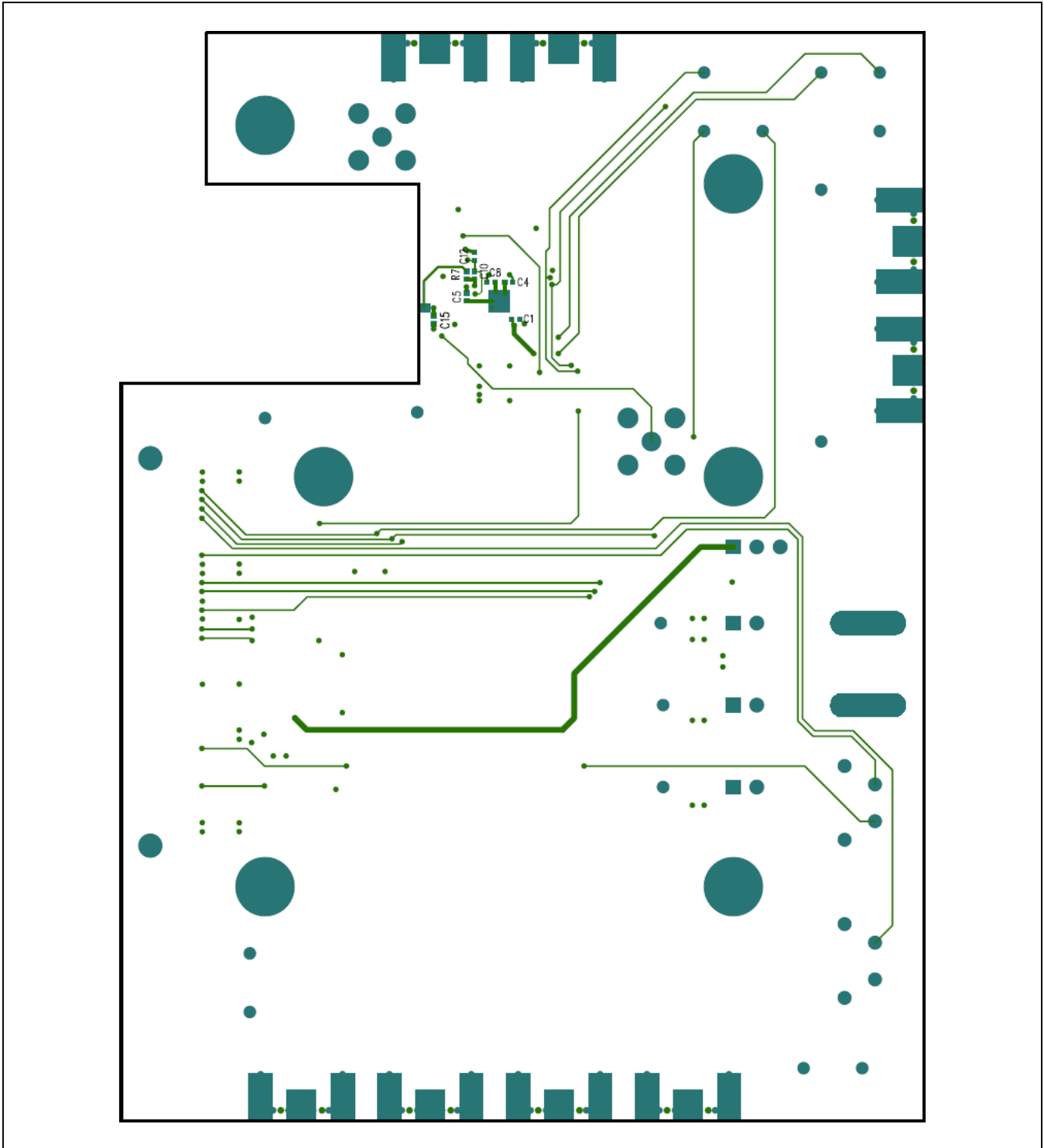

Figure 9. MAX3710 EV Kit PC Component Placement Guide—Solder Side

MAX3710 Evaluation Kit

Evaluates: MAX3710

Ordering Information

PART	TYPE
MAX3710EVKIT+	EV Kit

+Denotes lead(Pb)-free and RoHS compliant.

MAX3710 Evaluation Kit

Evaluates: MAX3710

Revision History

REVISION NUMBER	REVISION DATE	DESCRIPTION	PAGES CHANGED
0	8/11	Initial release	—
1	10/12	Updated resistor R2 in <i>Component List</i>	1



Maxim Integrated cannot assume responsibility for use of any circuitry other than circuitry entirely embodied in a Maxim Integrated product. No circuit patent licenses are implied. Maxim Integrated reserves the right to change the circuitry and specifications without notice at any time.

Maxim Integrated 160 Rio Robles, San Jose, CA 95134 USA 1-408-601-1000

13