



LatticeXP™ Advanced Evaluation Board

User's Guide

Introduction

Traditional SRAM-based FPGA solutions require additional non-volatile memory components be placed onto the printed circuit board (PCB), consuming additional resources and adding cost to the PCB solution. Alternatives to the SRAM-based FPGA include fuse based FPGAs or ASIC devices. While these solutions provide a non-volatile solution, they cannot be re-programmed.

The LatticeXP is a non-volatile, re-programmable FPGA solution, including both SRAM-based FPGA cells for easy reconfiguration and Flash-based memory for non-volatility, all in one efficient package.

The LatticeXP Advanced Evaluation Board is designed to help the user examine key features of the LatticeXP device and to aid in the development of custom designs. It is a ready-made, proven platform that includes a variety of industry-standard memory and communication interfaces.

Please check the Lattice web site for updates to this user's guide at: www.latticesemi.com/boards. Please note the revision number on the front of this document.

Features

- Single board solution for evaluation of the LatticeXP FPGA
- LatticeXP FPGA in a 388-ball fpBGA package
- DDR SODIMM socket and DDR power generation
- FCRAM interface and memory
- 10/100/1000 Mbps Ethernet PHY to an RJ45 connector
- PCI plated finger connections
- Seven-segment LED
- Eight LEDs for visual feedback
- Eight-position switch input
- 1149.1 JTAG programming/boundary scan interface
- Built-in power supply operating from 5V external supply (AC adapter included)
- Selectable CORE voltage for the LatticeXP
- Selectable voltages for all eight I/O banks
- Built in oscillator for reference clocks
- SMA connectors to LatticeXP clock input and general purpose I/O pins
- 100mil center-center test point grid

General Description

The heart of the LatticeXP Advanced Evaluation board is the LatticeXP FPGA. Around this core device are several industry standard interfaces and protocol devices.

The LatticeXP is manufactured to operate with multiple 1.2V to 5V voltage ranges. The LFXP10E device requires a core voltage supply at 1.2V and an auxiliary I/O supply at 3.3V. The LFXP10C device requires a core voltage supply at 1.5V-3.3V, and an auxiliary 3.3V supply. The LatticeXP Advanced Evaluation Board provides four supply voltages, all sourced from a 5V external source. The board provides fixed 1.2V, 2.5V and 3.3V power rails, and a single adjustable voltage that ranges from 1.2V to 3.3V. It is possible to use external power supplies to override the fixed output levels, if it is required. The voltage supplied to the LatticeXP core is selectable using shunts.

Once a correct set of supply voltages has been applied to the LatticeXP FPGA, the device is ready for programming. The LatticeXP FPGA is typically programmed and verified from the 1149.1 JTAG interface. A JTAG download cable can be connected onto either a 1x10 SIP header or a 2x5 DIP header. The LatticeXP is typically programmed using the Lattice ispVM[®] System software. The ispVM System software can be downloaded from the Lattice web site at www.latticesemi.com/software. ispVM System 15.2 or later should be used to program the LatticeXP device. The ispVM System software can be used to program either the SRAM memory or the Flash cells. The internal Flash memory on the LatticeXP device can be reprogrammed in the background while the FPGA is operating.

LatticeXP devices can also be programmed using either serial or parallel interfaces. The parallel interface permits either the SRAM or the Flash PROM memories to be programmed in the same manner as the JTAG port. The slave serial and master serial modes available on the LatticeXP only program the SRAM memory. The LatticeXP Advanced board does not support these alternate programming modes directly. Test points are provided on the board for connecting to the serial programming points. The parallel programming interface is inaccessible since it is connected to provide the FCRAM memory function.

Once programmed, the LatticeXP device has access to several interfaces designed to highlight FPGA features. The LatticeXP directly interfaces to a set of switches, LEDs, a seven segment display, a prototype grid, a FCRAM chip, Double-data-rate DRAM, a set of SMA connectors, a PCI bus and an Ethernet PHY device.

One of the key interfaces supported directly in the LatticeXP FPGA is easy support for DDR DRAM memories. The evaluation board provides a DDR SODIMM socket for inserting SODIMM DDR modules. The LatticeXP directly controls the address and memory strobes and connects to a 16-bit data bus. The data bus requires data qualification strobes (DQS) also be present. The LatticeXP FPGA series has an internal hardware assist for managing the DQS signals. These signals are connected to the DDR SODIMM. The DDR interface is capable of running at 167MHz (333 DDR).

The FCRAM interface also uses the LatticeXP DQS hardware assist. The LatticeXP Advanced Evaluation board provides a single FCRAM device, providing an eight-bit data bus. Data rates to between the FCRAM and the LatticeXP are equivalent to the DDR interface.

The evaluation board also provides a 3.3V 33MHz, 32-bit PCI interface. The board is designed to only be inserted into 3.3V PCI backplanes. It is not recommended to install the board into a 5V backplane. The LatticeXP FPGA is not directly 5V tolerant. In order for the device to be placed into a 5V system the PCI I/O clamp diodes must be enabled, and series current limiting resistors need to be on each 5V I/O.

The evaluation board includes a 10/100/1000 Ethernet PHY device (National Semiconductor DP83865). All of the necessary support components are provided to connect to a 10/100/1000 Base-T network. The physical side of the PHY connects to an RJ45 connector with built-in isolation magnetics and a 3KV capacitor. The Media Independent Interface (MII) is connected to the LatticeXP FPGA. The LatticeXP must be programmed with a Media Access Controller (MAC) before Ethernet traffic can be routed across the interface.

Additional features of the LatticeXP Advanced Evaluation board are described in detail in the following section.

Additional Resources

Additional resources related to this board can be downloaded from the web at www.latticesemi.com/boards. Click on the appropriate evaluation board, then see the blue "Resources" box on the right of the screen for items such as: updated documentation, software, sample designs, IP evaluation bitstreams, and more.

LatticeXP Advanced Evaluation Board Functional Description

The LatticeXP Advanced Evaluation Board is comprised of several primary functional blocks as shown in Figure 1. In the descriptions below, locations of components and board features will be described relative to a compass symbol placed adjacent to the Lattice logo. For example, the seven-segment LED is on the northwest corner of the board, and the trimmer potentiometer is on the southeast corner of the board.

Figure 1. LatticeXP Advanced Evaluation Board Functional Blocks

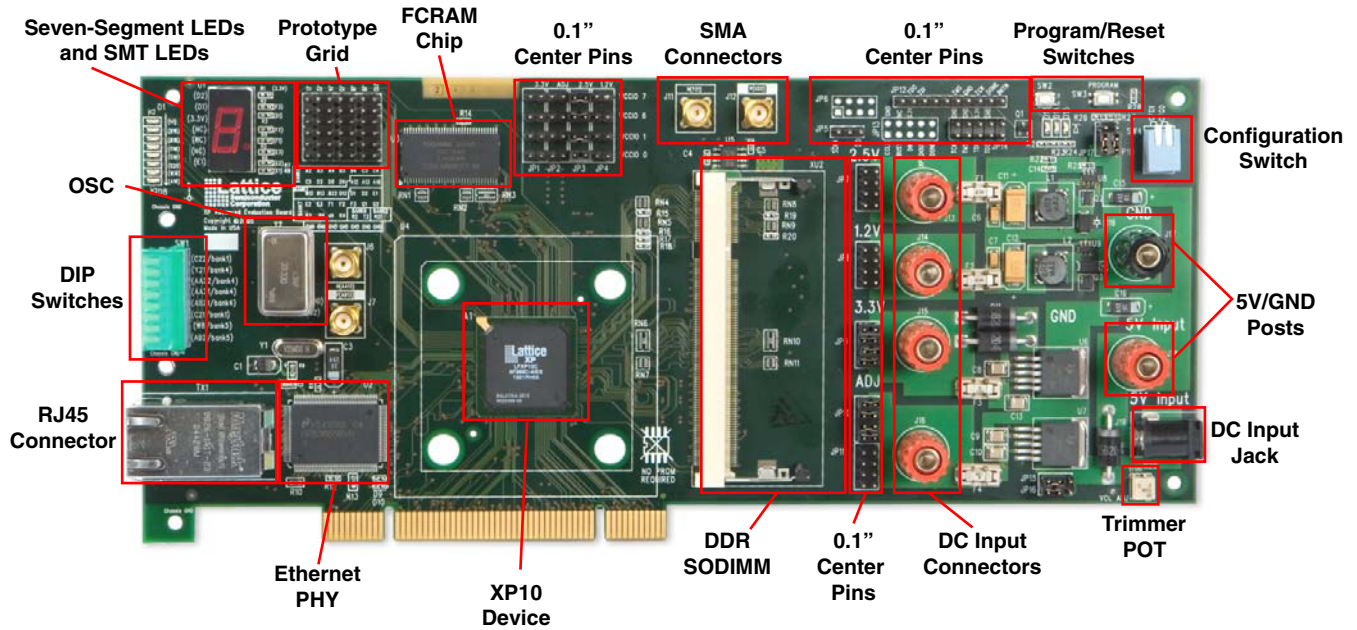

Power Supply

The LatticeXP Advanced Evaluation Board provides three locations to apply power. On the east side of the board are a pair of banana jacks (J18 and J17), and a coaxial DC connector (J19), which receive power from either a bench power supply or a brick style power supply. The third method for powering the board is to place it in a PCI host. Do not provide a supply voltage from the other DC input sources when the board is plugged into a PCI host backplane. In order to power the board, a DC source between 5V and 5.5V must be applied to the DC input jack or the 5V/GND banana connectors. Alternately 3.3V must be supplied from the PCI interface.

The 5V DC input voltage is converted by DC-DC converters and switching power supplies to provide 3.3V, 2.5V, 1.2V, and an adjustable DC source. The output from these supplies travels through surface mounted fuse holders. Fuses are supplied and prevent over-current conditions from damaging the power supply circuitry.

Each of the DC converters can be enabled and disabled independently. Jumpers JP15-18 control the conversion system.

Table 1. Power Supply Enable/Disable

Jumper Number	Supply Rail Enabled/Disabled	Function
JP15	V _{ADJ}	1-2: Disable 2-3: Enable
JP16	3.3V	1-2: Disable 2-3: Enable
JP17	2.5V	1-2: Disable 2-3: Enable
JP18	1.2V	1-2: Disable 2-3: Enable

More banana jack inputs are located immediately next to (west of) the fuse blocks. These inputs provide an alternate means for applying DC voltage levels to the board. To apply voltages not supplied by the on-board power circuitry, simply remove the appropriate fuse from the fuse holder, then connect an alternate DC supply to the banana jack associated with that fuse.

Table 2. Power Supply Fuses

Fuse Number	Supply Rail Enabled/Disabled	Banana Jack Input
F1	2.5V	J6
F2	1.2V	J7
F3	3.3V	J8
F4	V _{ADJ}	J9

A set of 2x4 100mil headers (JP7-JP11) are located next to (west of) the banana jacks (J13-J16). All but one of these headers control the LatticeXP core voltage setting. JP10 connects to the Ethernet PHY (U2) and does not connect to the core voltage of the LatticeXP device. JP10 is connected to V_{ADJ} on one side and to the PHY core supply on the other. When using the PHY, V_{ADJ} must be set to 1.8V. Do not remove power from the Ethernet PHY core. Doing so may damage the Ethernet PHY.

The remaining jumper blocks must have only one supply rail connected to the LatticeXP core voltage. The jumpers placed on the jumper block must run in an east-west orientation. The jumper blocks assign the core voltage as follows:

Table 3. LatticeXP Core Voltage Selection

Jumper Block	Voltage Supplied to the LatticeXP Core
JP7	2.5V
JP8	1.2V 'E' series LatticeXP only
JP9	3.3V
JP11	V _{ADJ}

R29 is a trimmer potentiometer which controls the output level of the V_{ADJ} section of the power supply. R29 is located in the southeast corner of the board. The V_{ADJ} can be set between 1.2V and 3.3V.

Programmability

Components and logic related to programming the LatticeXP FPGA are located in the northeast corner of the board. These include a set of switches, jumpers, push buttons and header blocks that modify how the LatticeXP programs itself when power is applied.

Figure 2. Programming Interface

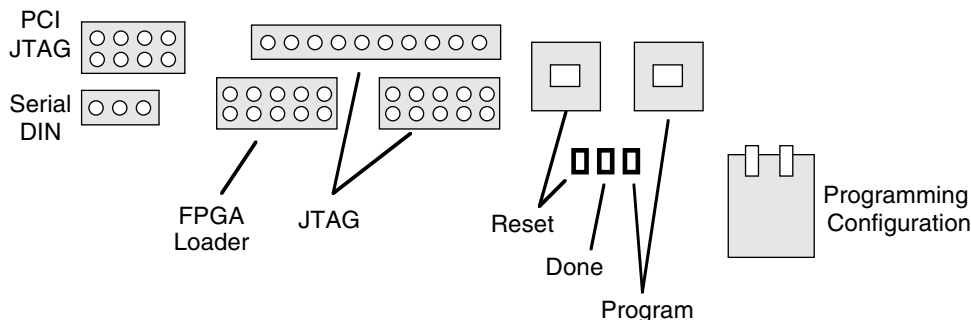

SW4 Configuration

SW4 directs the LatticeXP to a programming data source used to configure the on-chip SRAM. SW4 is located on the east side of the board. Table 4 shows the mode for each switch setting.

Table 4. LatticeXP Programming Configuration

SW4 Setting CFG1:CFG0	Mode
Up:up	Self-download mode CPU Flash programming
Up:down	Slave parallel programming
Down:up	Master serial programming
Down:down	Slave serial programming

SW4 is typically set with both switches up. The LatticeXP loads configuration data from the on-chip internal Flash memory.

The LatticeXP Advanced Evaluation board does not support the Slave Parallel programming mode since the data bus and controls for this mode are dual-use pins, connected to the FCRAM interface.

Slave and Master Serial programming modes are also available. The serial mode interface is available using JP5 (Serial DIN) and JP13 (FPGA Loader). See the LatticeXP Evaluation Board schematic at the end of this document for further details concerning the connectivity for the serial mode I/Os.

Table 5. LatticeXP Serial DIN Header Settings

Serial DIN Header	Action
1:2	JP13 DIN to XP DIN
2:3	Reserved
Open	XP DIN available for general purpose I/O

Push-buttons and Status LEDs

There are two push-buttons and three LEDs in the northeast corner of the evaluation board (see Figure 2). The Program push-button asserts the PROGRAM pin on the LatticeXP device, erasing the SRAM and causing the LatticeXP to begin a programming sequence. Pushing the button also illuminates a yellow LED, giving confirmation the switch has been closed.

The other push-button acts as a RESET input to the LatticeXP. The LatticeXP does not have a dedicated RESET input. RESET must be assigned an I/O when the device is programmed. This is done by instantiating the Global Reset macro in the HDL source. A red LED is illuminated whenever the RESET button is pushed.

The third LED is connected through a small amount of control circuitry to the LatticeXP DONE I/O. DONE is driven high when the LatticeXP is successfully programmed. When DONE is driven high, this green LED turns on. This LED is active when the LatticeXP is programmed using the JTAG header. When a JTAG programming sequence is initiated, the LatticeXP I/Os are tristated. The tristated I/Os float high, which mimics the open-drain high assertion of DONE following a successful programming sequence. At the completion of a JTAG programming sequence, the DONE LED will stay illuminated if the programming sequence succeeded. It will turn off if the sequence did not succeed.

Programming Headers

The LatticeXP Advanced Evaluation Board provides two JTAG headers for programming the LatticeXP device. These headers are wired in parallel, and only differ in form factor. JP12 is a 1x10 100mil header, and JP14 is a 2x5 100mil header. Either can be used with a Lattice USB or parallel port download cable. The download cable used with ispVM System software may have either fly-wire JTAG wires, or the JTAG wires in a captive header. Figure 3 shows how the fly-wire JTAG wires are connected to the 1x10 header.

Important Note: The board must be un-powered when connecting, disconnecting, or reconnecting the ispDOWNLOAD Cable. Always connect the ispDOWNLOAD Cable's GND pin (black wire), before connecting any other JTAG

pins. Failure to follow these procedures can in result in damage to the LatticeXP FPGA device and render the board inoperable.

Figure 3. JTAG Fly-wire Connections

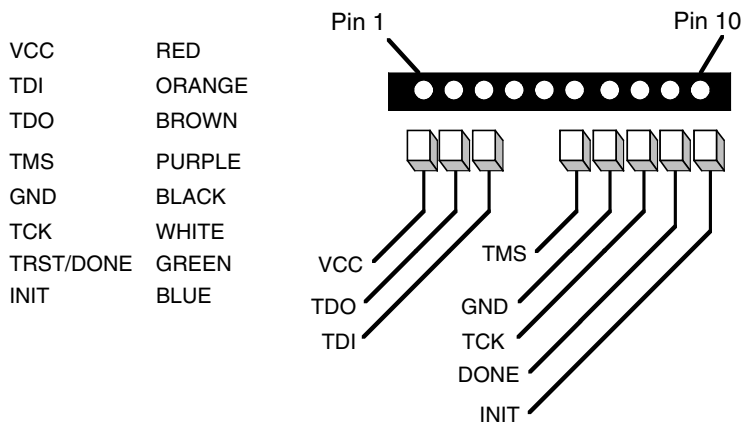

The 2x5 programming header only connects the four basic JTAG signals, and the VCC source. The silkscreen provided on the board shows the connection points for each wire. All of the remaining fly-wires are left unconnected.

Regardless of which header is used, the ispVM System software is used to control the download cable. Configure the ispVM software to use the cable type connected to the evaluation board (parallel port or USB). Select the bit-stream to download, and the memory space to which the data will be written (SRAM or FLASH). See the ispVM System Help for more information.

Table 6. Programming Interface Connection Summary

Function	LatticeXP Pin Location	JP 13 Pin	JP 6 Pin	JP 12 Pin	JP 14 Pin	Note
BUSY	C11	JP13 (3)				
CCLK	G4	JP13 (1)				
DONE	B1	JP13 (9)		JP12 (9)		D14 (Green LED)
INITN	Y2	JP13 (8)		JP12 (10)		
PROGRAMN	F4	JP13 (10)				D15 (Yellow LED)
TCK	D18		JP6 (8)	JP12 (8)	JP14 (1)	
TDI	D20		JP6 (4)	JP12 (3)	JP14 (5)	
TDO	F19		JP6 (2)	JP12 (2)	JP14 (7)	
TMS	D19		JP6 (6)	JP12 (6)	JP14 (3)	

Table 7. Supplemental Programming Interface Connection Summary

Schematic Name	LatticeXP Pin Location	JP 5 Pin
CFG0	C1	
CFG1	B2	
D0	D10	
DIN_2_D0	C13	JP5 (3)
DIN_2_SDIN	A7	JP5 (1)

Important: Use only ispVM System version 15.2 or later to program the LatticeXP device.

LatticeXP and Support Interfaces

The LatticeXP Advanced Evaluation Board includes advanced interfaces such as DDR, PCI, FCRAM and Ethernet. These are complex either by the nature of the signaling interface, or by the internal programming required to operate them. Lattice provides bitstreams which can be used to evaluate the performance of the LatticeXP FPGA on several of these interfaces. Lattice also provides precompiled intellectual property cores for controlling the FCRAM, DDR, PCI and the Ethernet. These precompiled intellectual property cores can be used to design and simulate an integrated solution. An intellectual property license is required to generate customized programming bitstreams. Visit the Lattice web site at www.latticesemi.com/boards to find the latest available evaluation bitstreams for these interfaces.

The LatticeXP Advanced Evaluation Board uses the following conventions.

- Devices are numbered in a consistent fashion. Each device starts at reference designator '1' in the northwest corner of the board (i.e. R1, C1, U1, L1, etc.). The component number increases by one in a columnar fashion (i.e. southward). When the south edge of the board is reached, the count resumes slightly east, and at the north side of the board. Thus the highest numbered components will always be in the southeast corner of the board. This same numbering sequence is applied to the reverse side of the printed circuit board.
- Adjacent to the switch inputs, LED outputs, SMA connectors and test points is the alphanumeric position of the pin on the LatticeXP FPGA. For example, next to the DIP oscillators (pin 10 in the silkscreen) is the designator (A10). This indicates XU2 pin 10 is connected to the LatticeXP A10 pin.
- SMA connectors have a solid white rectangular area near them denoting the positive side of a matched pair. The negative side of a matched pair has a white outline rectangle area.

For detailed information concerning the pin connections for these interfaces, see the appropriate connection summary tables in the following pages, and the LatticeXP Advanced Evaluation Board schematics in Appendix A.

VCCIO Power

The LatticeXP provides eight banks for configuring different input/output voltages and different input/output protocols. The LatticeXP Advanced Evaluation board permits four of these I/O banks to be statically configured based on the requirements of the design. VCCIO bank 2/3 is fixed to 2.5V. These two banks interface to the DDR SODIMM socket. The DDR memory only operates at 2.5V, so making these two banks I/O voltage adjustable is not very useful. Banks 4/5 are set to 3.3V, which configures the I/O correctly for the PCI bus. Banks 0,1, 6, and 7 can be configured to different I/O voltage levels. VCCIO power selection is made using the header in the north-central section of the board (see Figure 4).

Figure 4. VCCIO Voltage Selection Header

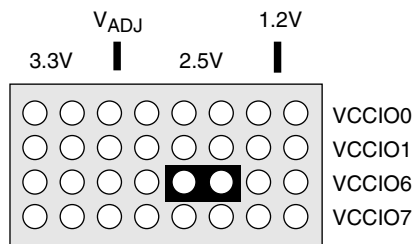

Figure 4 shows how VCCIO6 would be configured to use a 2.5V supply for the output buffer drive level.

Prototype Grid

The board provides a small 100mil center-center prototype area just to the west of the VCCIO power selection jumpers. This area is connected to FPGA I/Os primarily in banks 0, 1, 6 and 7. The silkscreen near the prototype grid provides a map describing the FPGA alphanumeric grid number and bank of the I/O.

Please note that some of the bank 7 I/Os are connected in parallel with the seven-segment LED. Also, H21 is one of the PLL input pins, so an additional clock frequency can be injected into the FPGA from the prototype area. Refer to Table 8 for a complete description of the prototype area connections.

Table 8. Prototype Area Connection Summary

Board Location	LatticeXP Pin Location	Schematic Name	Note
J1 (1)	A2	TP_A2	
J1 (2)	C5	TP_C5	
J1 (3)	B12	TP_B12	
J1 (4)	E2	SSEG_D	Also seven-segment display
J1 (5)	G3	TP_G3	
J2 (1)	A3	TP_A3	
J2 (2)	D3	TP_D3	
J2 (3)	B13	TP_B13	
J2 (4)	E3	SSEG_DP	Also seven-segment display
J2 (5)	H4	TP_H4	
J4 (1)	A4	TP_A4	
J4 (2)	D8	TP_D8	
J4 (3)	B22	TP_B22	
J4 (4)	F1	SSEG_C	Also seven-segment display
J4 (5)	J4	TP_J4	
J5 (1)	B3	TP_B3	Also DIN_2_SDIN
J5 (2)	D9	TP_D9	
J5 (3)	D12	TP_D12	Also DIN_2_D0
J5 (4)	F2	SSEG_G	Also seven-segment display
J5 (5)	K4	TP_K4	
J8 (1)	B4	TP_B4	
J8 (2)	A12	TP_A12	
J8 (3)	D1	SSEG_F	Also seven-segment display
J8 (4)	F3	SSEG_B	Also seven-segment display
J8 (5)	R2	TP_R2	
J9 (1)	C3	TP_C3	
J9 (2)	A13	TP_A13	
J9 (3)	D2	SSEG_A	Also seven-segment display
J9 (4)	G1	TP_G1	
J9 (5)	T2	TP_T2	
J10 (1)	C4	TP_C4	
J10 (2)	A18	TP_A18	
J10 (3)	E1	SSEG_E	Also seven-segment display
J10 (4)	G2	TP_G2	
J10 (5)	H21	TP_H21	Also PLL input

LED Displays

In the northwest corner of the board are two different types of LEDs. Eight chip-style LEDs are connected to I/O pins dedicated to driving the LEDs. The silkscreen indicates the alphanumeric location of the driving I/O. These locations are also indicated in Table 9. The LEDs illuminate when the corresponding I/O is driven to V_{OL} .

Table 9. LED Connection Summary

LED Number	LatticeXP Pin Location	Schematic Name
D1	H1	TP_H1
D2	B16	TP_B16
D3	B18	TP_B18
D4	C18	TP_C18
D5	C19	TP_C19
D6	C20	TP_C20
D7	W16	TP_W16
D8	A16	TP_A16

A seven-segment LED is located in the northwest corner of the board. Unlike the chip LEDs, the I/Os driving the seven-segment display are not dedicated. These LED segments are also connected to the prototype grid. Illuminating one of the LED segments works in the same way as the chip LEDs. Each segment, when driven toward V_{OL} , will illuminate. Refer to Table 10 for a complete description of the seven-segment display connections.

Table 10. Seven-segment Display Connection Summary

Display Segment	LatticeXP Pin Location	Alternate Header Connection	Schematic Name
SSEG_A	D2	J9 (3)	TP_D2
SSEG_B	F3	J8 (4)	TP_F3
SSEG_C	F1	J4 (4)	TP_F1
SSEG_D	E2	J1 (4)	TP_E2
SSEG_DP	E3	J2 (4)	TP_E3
SSEG_E	E1	J10 (3)	TP_E1
SSEG_F	D1	J8 (3)	TP_D1
SSEG_G	F2	J5 (4)	TP_F2

Switches

A set of eight simple toggle switches is located at the west edge of the board. The silkscreen indicates the alphanumeric location of the I/O on the FPGA. When in the up position, the switch is pulled to 3.3V through a 10K resistor. When in the down position, the switch is tied to ground. Refer to Table 11 for a complete description of the switch connections.

Table 11. Switch Connection Summary

Board Location	LatticeXP Pin Location	Schematic Name
SW1_1	C22	TP_C22
SW1_2	Y21	TP_Y21
SW1_3	AA22	TP_AA22
SW1_4	AA21	TP_AA21
SW1_5	AB21	TP_AB21
SW1_6	C21	TP_C21
SW1_7	W8	TP_W8
SW1_8	AB2	TP_AB2

Oscillator and Clock Inputs

FPGA designs are nearly always created with logic synchronous to some reference frequency. The FPGA has four PLLs and multiple primary clock inputs. Some of these clock inputs are dedicated to a particular interface on the evaluation board. There are several ways to input reference clock frequencies.

LatticeXP pins U22 and T21 are connected to SMA connectors. These two SMAs are connected to the positive and negative pairs of one of the four PLLs provided by the FPGA. The characteristic impedance of the traces is 50 ohms.

Two additional SMA connectors provide a matched pair (positive and negative) of traces to one of the Primary Clock inputs. This pair of traces enter the FPGA at pins AB13 (positive) and AA13 (negative). The characteristic impedance of the traces is 50 ohms.

Table 12. SMA Connection Summary

Board Location	LatticeXP Pin Location	Schematic Name
J6 SMA	AA13	PRI_CLK_N
J7 SMA	AB13	PRI_CLK_P
J11 SMA	U22	SMA_U22
J12 SMA	T21	SMA_T21

The PLL input and the Primary Clock are also programmable as general purpose I/Os. This permits these I/Os to be evaluated in operation over coaxial cables.

The board also provides a 14-pin 3.3V clock oscillator device. The oscillator is in a 16-pin DIP socket. Using a socket permits the use of an arbitrary input clock frequency and the use of oscillators with different accuracy and jitter characteristics.

The oscillator socket is also wired to permit the use of either full-size or half-size DIP oscillators. Figure 5 shows the configuration options available.

Figure 5. Oscillator Input Options

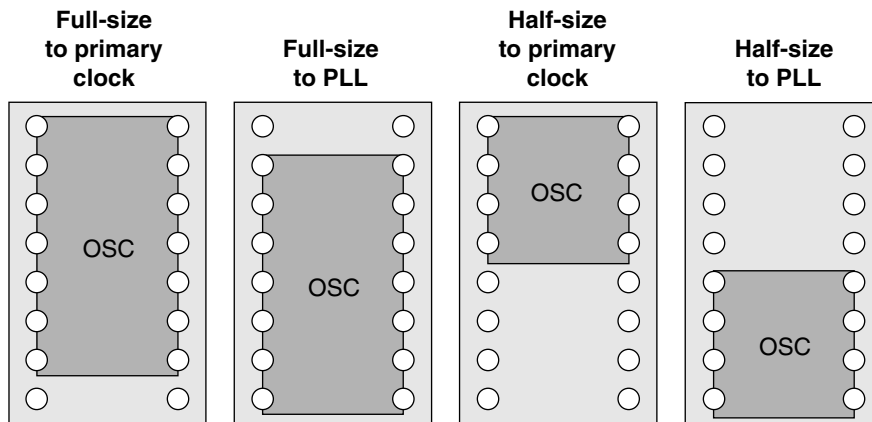

The socket is wired such that pins 10 and 13 are connected to the same Primary Clock input (pin A10). Pin 9 is connected to a PLL input (pin J2) in bank 7 on the FPGA.

The last location provided on the board for supplying external clock frequencies lies in the prototype area. FPGA pin H21 is the positive side of one of the four PLL inputs. An arbitrary clock frequency can be supplied to the FPGA from J10 pin 5 in the prototype grid.

10/100/1000 Ethernet PHY

In the southwest corner of the board is a National Semiconductor Gigabit Ethernet PHY (DP83865). The LatticeXP FPGA interacts with the PHY over a Media Independent Interface (MII). The PHY is connected to an RJ45 header on the Media Dependent Interface (MDI). The RJ45 connector has built-in magnetics and spark-gap capacitor. The PHY is available on the board in order to demonstrate the Lattice Ethernet Media Access (MAC) IP core. However, it is also possible to use the PHY to evaluate a custom MAC solution. Refer to the schematic and the National Semiconductor DP83865 Data Sheet for detailed information about the operation of the Ethernet PHY interface on this device. Refer to Table 13 for a description of the ethernet PHY connections.

Table 13. 10/100/1000 Ethernet PHY Connection Summary

Schematic Name	LatticeXP Pin Location
ETH_CLK_TO_MAC	L4
ETH_COL	W1
ETH_CRS	W2
ETH_EGP0	J1
ETH_EGP2	K2
ETH_EGP4	K3
ETH_EGP5	J3
ETH_EGP6	K1
ETH_EGP7	L2
ETH_GTX_CLK	N4
ETH_MAC_CLK_EN	L3
ETH_MDC	M1
ETH_MDIO	L1
ETH_RESET_N	Y1
ETH_RX_CLK	P1
ETH_RX_D0	T3
ETH_RX_D1	N2
ETH_RX_D2	U4
ETH_RX_D3	U3
ETH_RX_D4	U2
ETH_RX_D5	P2
ETH_RX_D6	V4
ETH_RX_D7	V3
ETH_RX_DV	V2
ETH_RX_ER	V1
ETH_TX_CLK	H2
ETH_TX_D0	M4
ETH_TX_D1	N3
ETH_TX_D2	R1
ETH_TX_D3	P4
ETH_TX_D4	P3
ETH_TX_D5	M3
ETH_TX_D6	T1
ETH_TX_D7	R4
ETH_TX_EN	R3
ETH_TX_ER	T4

Required Board Modification

The LatticeXP Advanced Evaluation Board uses the National Semiconductor DP83865 GigaPhyter Ethernet PHY to provide network access. Lattice has discovered that the circuit placed on the XP Advanced board prevents correct operation upon applying power to the board.

In order for the Ethernet PHY to operate it is mandatory to modify the evaluation board. The tuned crystal oscillator circuit providing the 25MHz input clock to the GigaPhyter device is incorrect. A parallel termination resistor, R54, was placed according to guidelines published by National Semiconductor. The value selected for the termination resistor has been determined to be incorrect. The resistor attenuates the clock preventing the tuned circuit from providing sufficient output swing to the DP83865. This termination resistor is optional. R54 must be removed for the DP83865 to operate.

Putting the PHY into GMII Mode

Lattice has also determined the PHY device will power up in RGMII mode and the TX_CLK and RX_CLK signals will not oscillate. The PHY needs to be put into GMII mode. The DP83865 enters GMII mode in one of two ways. The first is by writing to the AUX_CTRL register using the MDIO interface. The second is by applying a pull-down resistor to the RGMII_EN[1] configuration pin. The configuration pin is read at power up, placing the DP83865 into GMII mode.

To make the DP83865 enter GMII mode at power up tie the DP83865 side of R71 to ground through a current limiting resistor. This rework is not mandatory. You can use MDIO transactions to write into the DP83865's registers, putting it into GMII mode. Using MDIO write the Auxiliary Control Register (AUX_CTRL) address 0x12, bits 13:12. The register description is as follows:

RGMII ENABLE: These two bits control RGMII mode or MII/GMII mode.
 RGMII_EN[1:0]
 11 = RGMII - 3COM mode
 10 = RGMII - HP mode
 01 = GMII mode
 00 = GMII mode

Lattice has tested putting a current-limiting pull-down resistor on the board. This will pull the TX_CLK / RGMII_SEL[1] bit to a '0' on power-up, putting the device automatically into GMII mode. This is based on the data sheet:

RGMII_SEL1	RGMII_SEL0	MAC Interface
0	0	GMII
0	1	GMII
1	0	RGMII – HP
1	1	RGMII – 3COM

In this example, a current limiting resistor of 2.2K was used. You can see the picture below of the fix. A resistor was soldered to R71 and a wire was soldered to the ground terminal of SMA J7.

Figure 6. Board Fix, R71 to GND

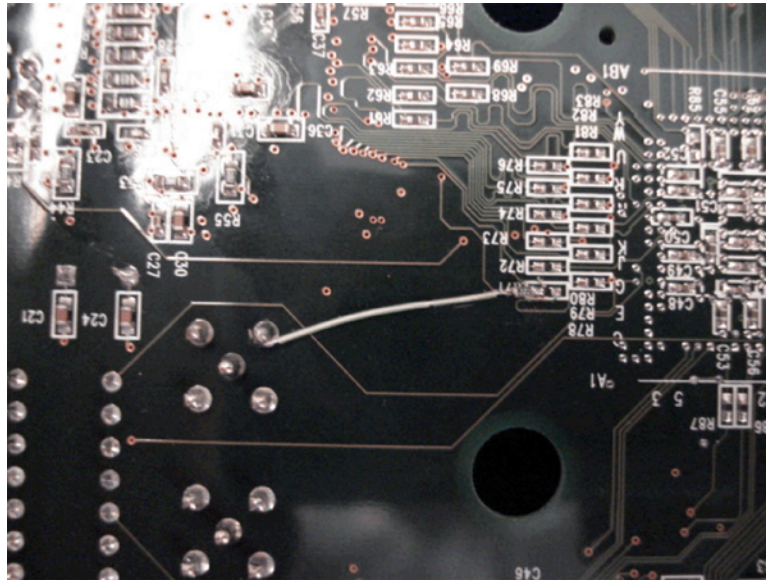

From the Ethernet PHY schematic in EB13, [LatticeXP Advanced Evaluation Board User's Guide](#), the fix would look like the figure below.

Figure 7. Schematic Diagram of R71 Fix

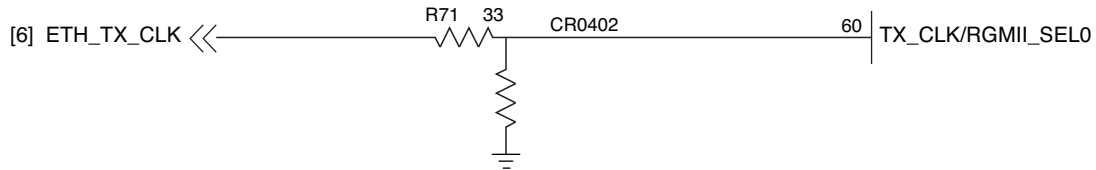

PCI Interface

The LatticeXP Advanced Evaluation Board includes a PCI bus interface. The PCI interface is capable of 33MHz operation, and provides a 32-bit data bus path. The board is designed to plug into 3.3V PCI systems exclusively since the LatticeXP I/O pins are not 5V tolerant. Figure 8 shows the PCI plated fingers and the notches used to prevent insertion into the wrong kind of backplane. Visit the Lattice web site at www.latticesemi.com/boards to download a test evaluation package for the PCI interface. Refer to Table 14 for a description of the PCI connections.

Figure 8. PCI Backplane Keys

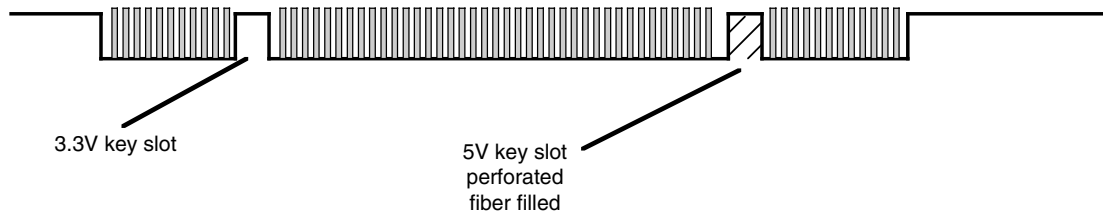

By default, the board is fabricated with the 5V cutout filled. In order to allow the board to be inserted into all PCI backplanes the 5V cutout is fabricated to permit it to be cut away. If the 5V cutout fiberglass is removed, Lattice does not take responsibility for damage to the FPGA, the evaluation board or the system the evaluation board is inserted into, should it occur.

The PCI traces are routed to the bottom (banks 4 and 5) of the LatticeXP FPGA. The pins on the top and bottom of the FPGA have PCI clamp diodes integrated into the I/O pins. The PCI clock, however, is routed to one of the PLL input pins. The PLL input pins reside on the left and right sides of the FPGA. The left and right side of the device do not have clamp diodes. To compensate for this, the board includes space to install PCI clamp diodes, if desired. Visit the Lattice web site at www.latticesemi.com/boards to download a test evaluation package for the PCI interface. Refer to Table 14 for a description of the PCI connections.

Table 14. PCI Connection Summary

Schematic Name	LatticeXP Pin Location
PCI_ACK64_N	AA20
PCI_AD0	AB18
PCI_AD1	AA18
PCI_AD10	AB15
PCI_AD11	AA15
PCI_AD12	W13
PCI_AD13	W12
PCI_AD14	AB14
PCI_AD15	AA14
PCI_AD16	AA12
PCI_AD17	AA10
PCI_AD18	Y8
PCI_AD19	AB8
PCI_AD2	Y18
PCI_AD20	AA8
PCI_AD21	Y7
PCI_AD22	AB7
PCI_AD23	AA7
PCI_AD24	Y10
PCI_AD25	Y9
PCI_AD26	AB6
PCI_AD27	AA6
PCI_AD28	AB5
PCI_AD29	AA5
PCI_AD3	AB17
PCI_AD30	AB4
PCI_AD31	W9
PCI_AD4	Y14
PCI_AD5	Y13
PCI_AD6	AA17
PCI_AD7	Y17
PCI_AD8	AB16
PCI_AD9	AA16
PCI_CBE0_N	AA19
PCI_CBE1_N	Y20
PCI_CBE2_N	W14
PCI_CBE3_N	W15
PCI_CLK	U1

Table 14. PCI Connection Summary (Continued)

Schematic Name	LatticeXP Pin Location
PCI_DEVSEL_N	AB10
PCI_FRAME_N	AB11
PCI_GNT_N	AB3
PCI_IDSEL	AB19
PCI_INTA_N	W6
PCI_INTB_N	Y6
PCI_INTC_N	Y4
PCI_INTD_N	Y5
PCI_IRDY_N	Y11
PCI_LOCK_N	AA9
PCI_PAR	W11
PCI_PERR_N	W10
PCI_PRSNT1_N	AB12
PCI_PRSNT2_N	Y19
PCI_REQ64_N	AB20
PCI_REQ_N	AA3
PCI_RST_N	AA4
PCI_SERR_N	AB9
PCI_STOP_N	AA11
PCI_TRDY_N	Y12

Double Data Rate SDRAM

The evaluation board includes a SODIMM DDR SDRAM socket. The LatticeXP is well suited to interfacing to DDR SDRAM memories. The LatticeXP FPGA family has dedicated I/O pins for controlling the Data Qualification Strobe (DQS) pin implemented in DDR. The DQS pin is used to signal valid data is present on the data bus. The FPGA provides a dedicated DQS I/O pin for each eight data bits on the DDR bus. Each DQS I/O spans 13 other LatticeXP I/O pins. Thus the eight data bits can be assigned to a wide range of FPGA pins. The high number of I/O pins available improves the likelihood of successfully routing the data bus on a PCB.

A standard SODIMM socket provides 64 data bits. The LatticeXP Advanced Evaluation Board only connects to 16 data bus bits. This subset is chosen to provide a demonstration of the DDR capabilities of the LatticeXP while still permitting other interfaces to be showcased. All of the remaining DDR control signals, including the serial data bus, are connected to the LatticeXP FPGA. The DDR memory interface operates up to a 166MHz clock rate.

The DDR specifies a fairly rigid set of requirements with respect to the reference and termination voltages. In order to meet these requirements the evaluation board uses a National Semiconductor LP2995 DDR power management chip. The LP2995 accepts a 2.5V input and provides a regulated V_{REF} and V_{TT} supply for the SODIMM socket. Visit the Lattice web site at www.latticesemi.com/boards to download a test evaluation package for the DDR SDRAM interface. Refer to Table 15 for a description of the DDR SDRAM connections.

Table 15. DDR SDRAM Connection Summary

Schematic Name	LatticeXP Pin Location
DDR_A0	R19
DDR_A1	R21
DDR_A10	T22
DDR_A11	M19
DDR_A12	M22

Table 15. DDR SDRAM Connection Summary (Continued)

Schematic Name	LatticeXP Pin Location
DDR_A2	P19
DDR_A3	R22
DDR_A4	P22
DDR_A5	P20
DDR_A6	N19
DDR_A7	P21
DDR_A8	M20
DDR_A9	N21
DDR_BA0	V22
DDR_BA1	T19
DDR_CAS_N	T20
DDR_CK0	H19
DDR_CK0_N	G19
DDR_CKE0	J20
DDR_CKE1	J19
DDR_DM0	D22
DDR_DM1	K21
DDR_DQ0	F21
DDR_DQ1	E22
DDR_DQ10	K22
DDR_DQ11	L22
DDR_DQ12	J21
DDR_DQ13	K19
DDR_DQ14	L19
DDR_DQ15	L20
DDR_DQ2	F22
DDR_DQ3	G22
DDR_DQ4	D21
DDR_DQ5	E21
DDR_DQ6	F20
DDR_DQ7	H20
DDR_DQ8	H22
DDR_DQ9	J22
DDR_DQS0	G21
DDR_DQS1	K20
DDR_RAS_N	U19
DDR_S0_N	W22
DDR_S1_N	U20
DDR_SA0	V21
DDR_SA1	W21
DDR_SA2	Y22
DDR_SCL	V19
DDR_SDA	V20
DDR_WE_N	U21

FCRAM Interface

The LatticeXP FPGA is connected to a single eight-bit FCRAM device. The LatticeXP Advanced Evaluation Board always has a quantity of scratch RAM since the FCRAM memory, unlike the DDR memory, cannot be removed. With the addition of an FCRAM memory controller into the FPGA, the FCRAM memory can be used to store data.

Operation of the FCRAM memory is similar, but not identical to, the DDR memory interface. Like DDR, FCRAM memories depend on a DQS to qualify when data is valid on the bus. This means the DQS hardware built into the LatticeXP can be used to improve data transfer reliability in the same way it is used in DDR.

Visit the Lattice web site at www.latticesemi.com/boards to download a test evaluation package for the FCRAM interface. Refer to Table 16 for a description of the FCRAM connections.

Table 16. FCRAM Connection Summary

Schematic Name	LatticeXP Pin Location
FCRAM_PD_N	B6
FC_A0	A21
FC_A1	A20
FC_A10	B14
FC_A11	C14
FC_A12	D14
FC_A13	D13
FC_A14	C12
FC_A2	B20
FC_A3	A19
FC_A4	B19
FC_A5	B17
FC_A6	A15
FC_A7	B15
FC_A8	D15
FC_A9	A14
FC_BA0	B7
FC_BA1	C6
FC_CLK	C9
FC_CLK_N	C10
FC_CS_N	B5
FC_DQ0	C7
FC_DQ1	B8
FC_DQ2	C8
FC_DQ3	A9
FC_DQ4	D11
FC_DQ5	B10
FC_DQ6	A11
FC_DQ7	B11
FC_DQS	B9
FC_FN	A5

Ordering Information

Description	Ordering Part Number	China RoHS Environment-Friendly Use Period (EFUP)
LatticeXP10C Evaluation Board - Advanced	LFXP10C-H-EV	

Technical Support Assistance

Hotline: 1-800-LATTICE (North America)
+1-503-268-8001 (Outside North America)

e-mail: techsupport@latticesemi.com

Internet: www.latticesemi.com

Revision History

Date	Version	Change Summary
July 2005	01.0	Initial release.
March 2007	01.1	Added Ordering Information section.
April 2007	01.2	Added important information for proper connection of ispDOWNLOAD (Programming) Cables.
September 2009	01.3	

© 2009 Lattice Semiconductor Corp. All Lattice trademarks, registered trademarks, patents, and disclaimers are as listed at www.latticesemi.com/legal. All other brand or product names are trademarks or registered trademarks of their respective holders. The specifications and information herein are subject to change without notice.

Appendix A. Schematics

Figure 9. 32-Bit PCI

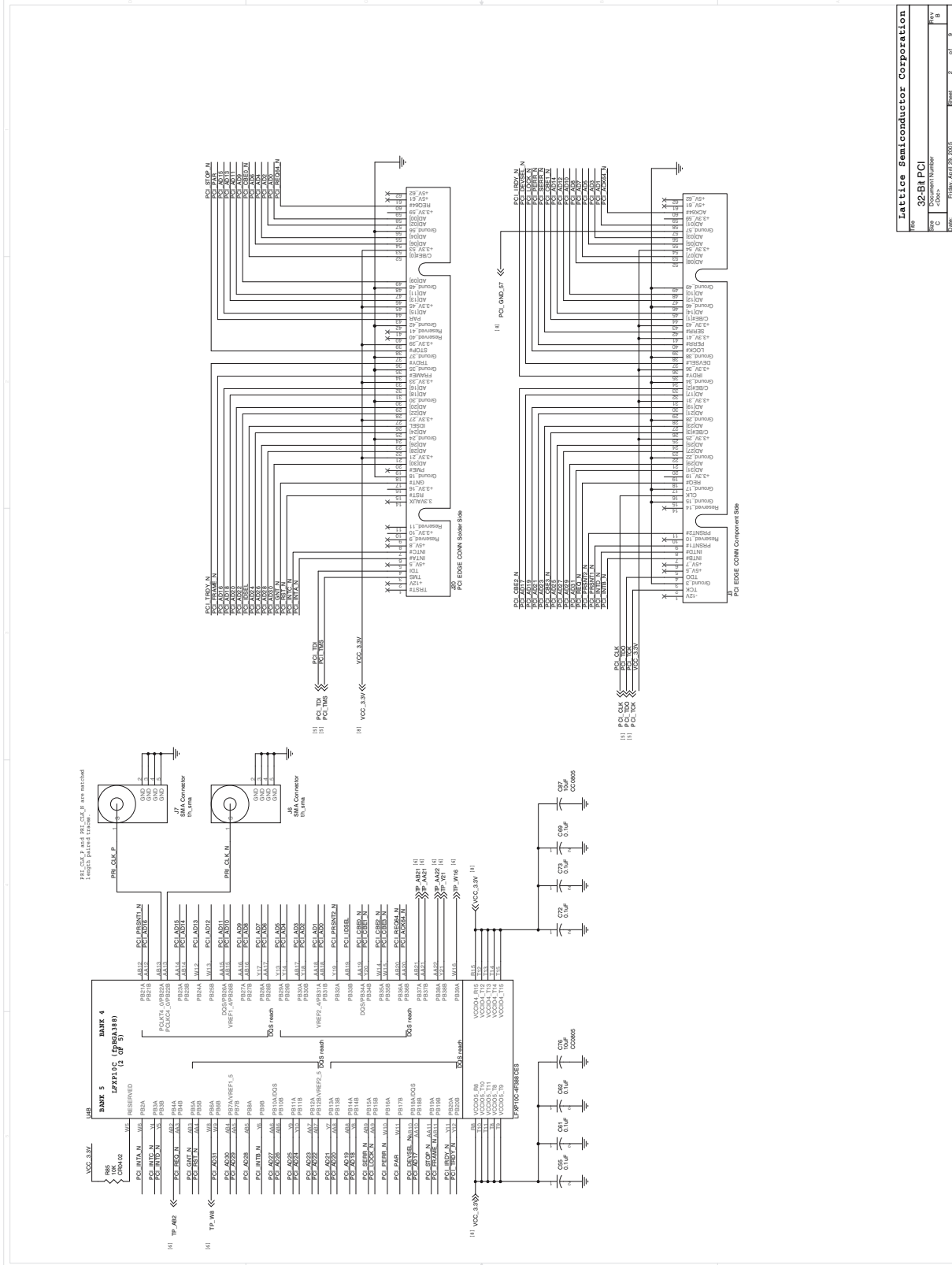

Lattice Semiconductor Corporation			
File:	32-Bit PCI	Rev:	B
Rev:	C	Docuement Number:	-000-
Date:	05/02/2005	Sheet:	2 of 3

Figure 10. DDR SDRAM

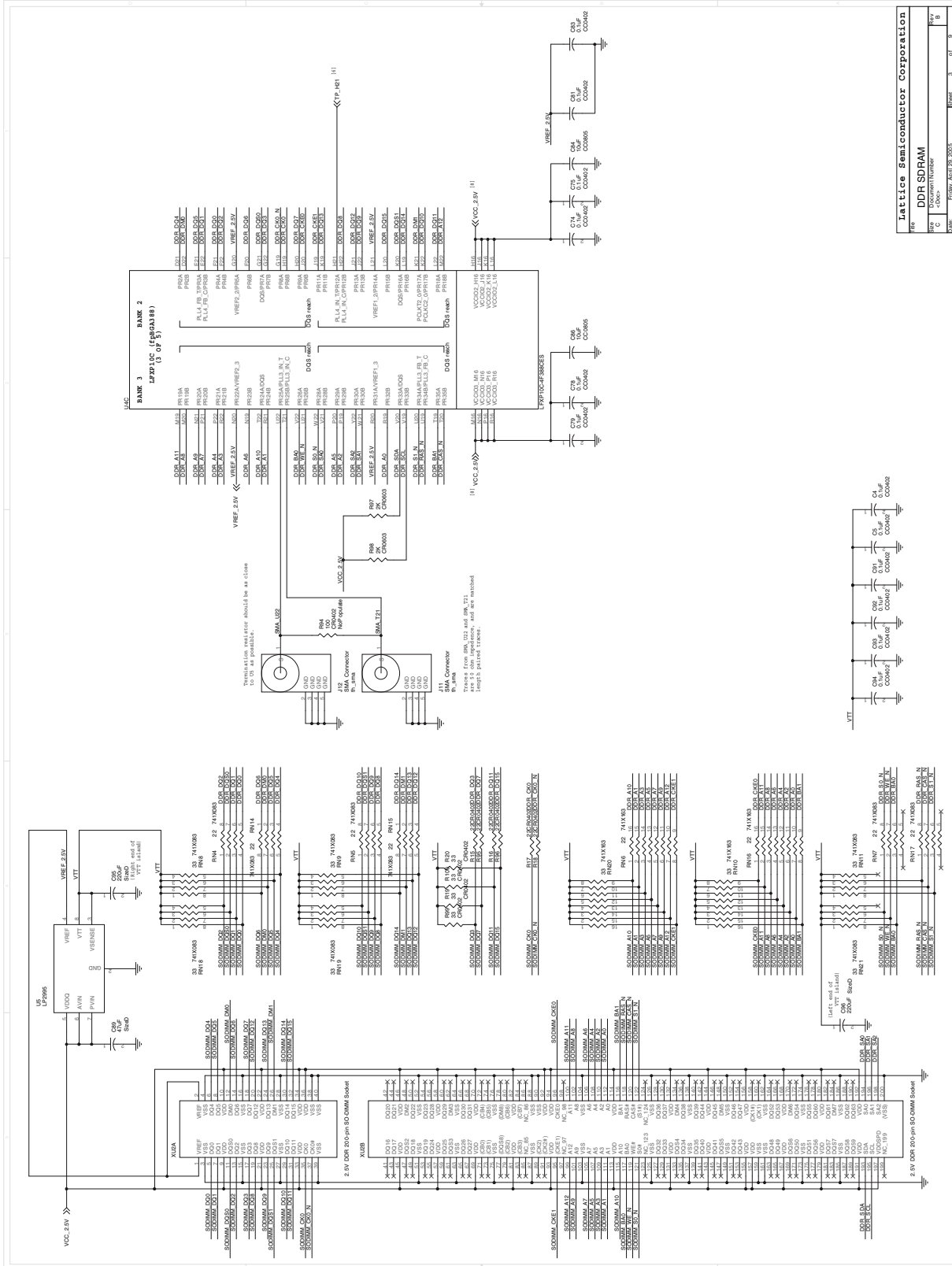

Lattice Semiconductor Corporation	
File:	DDR SDRAM
Doc:	DocumentNumber
Rev:	1
Date:	2008.03.03

Figure 11. FCRAM

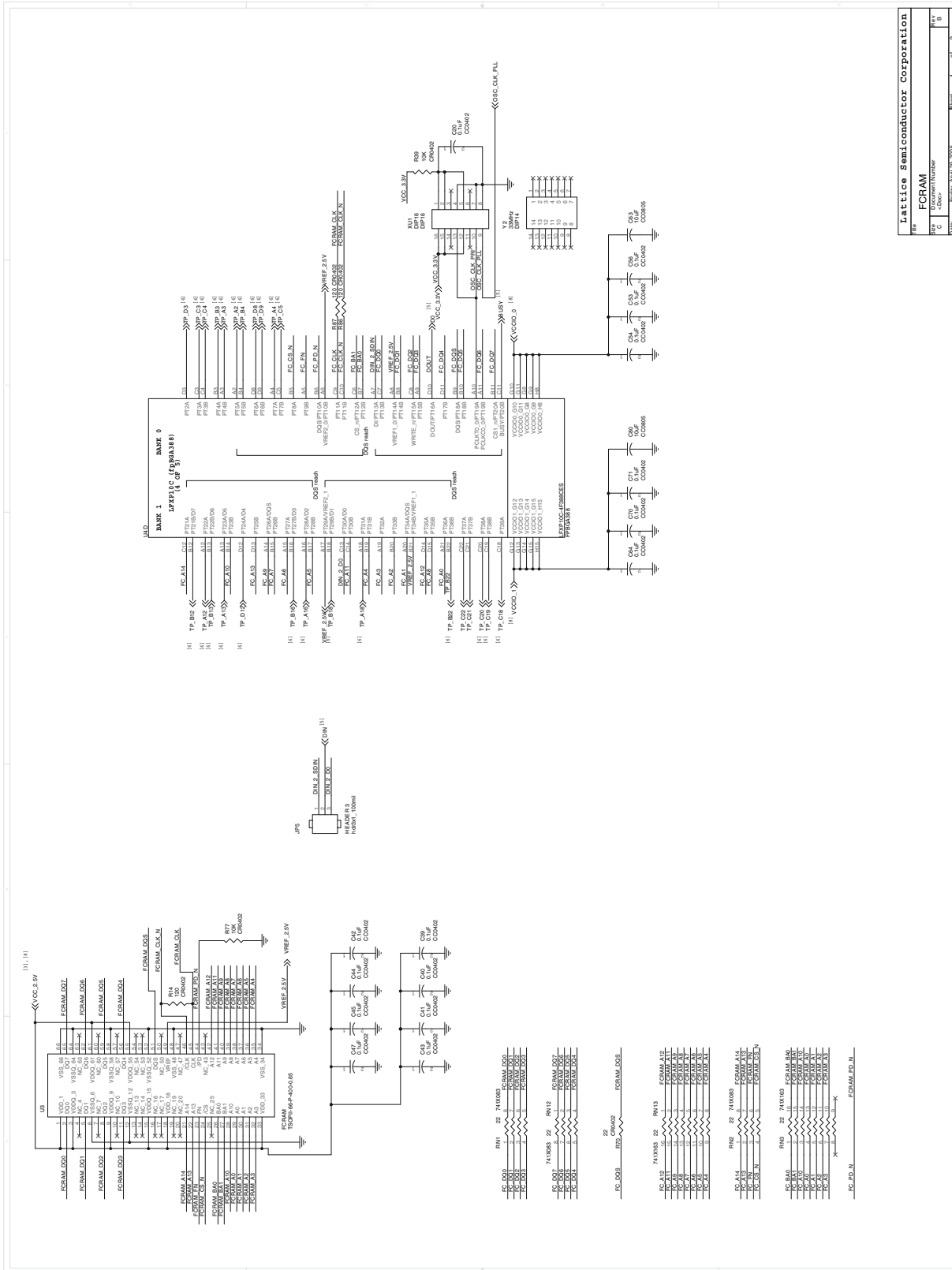

Lattice Semiconductor Corporation	
File:	FCRAM
Rev:	Document Number
C:	-000-
Rev:	FCRAM_Rev02_08_2005
Sheet:	1 of 1

Figure 12. JTAG and FPGA Programming

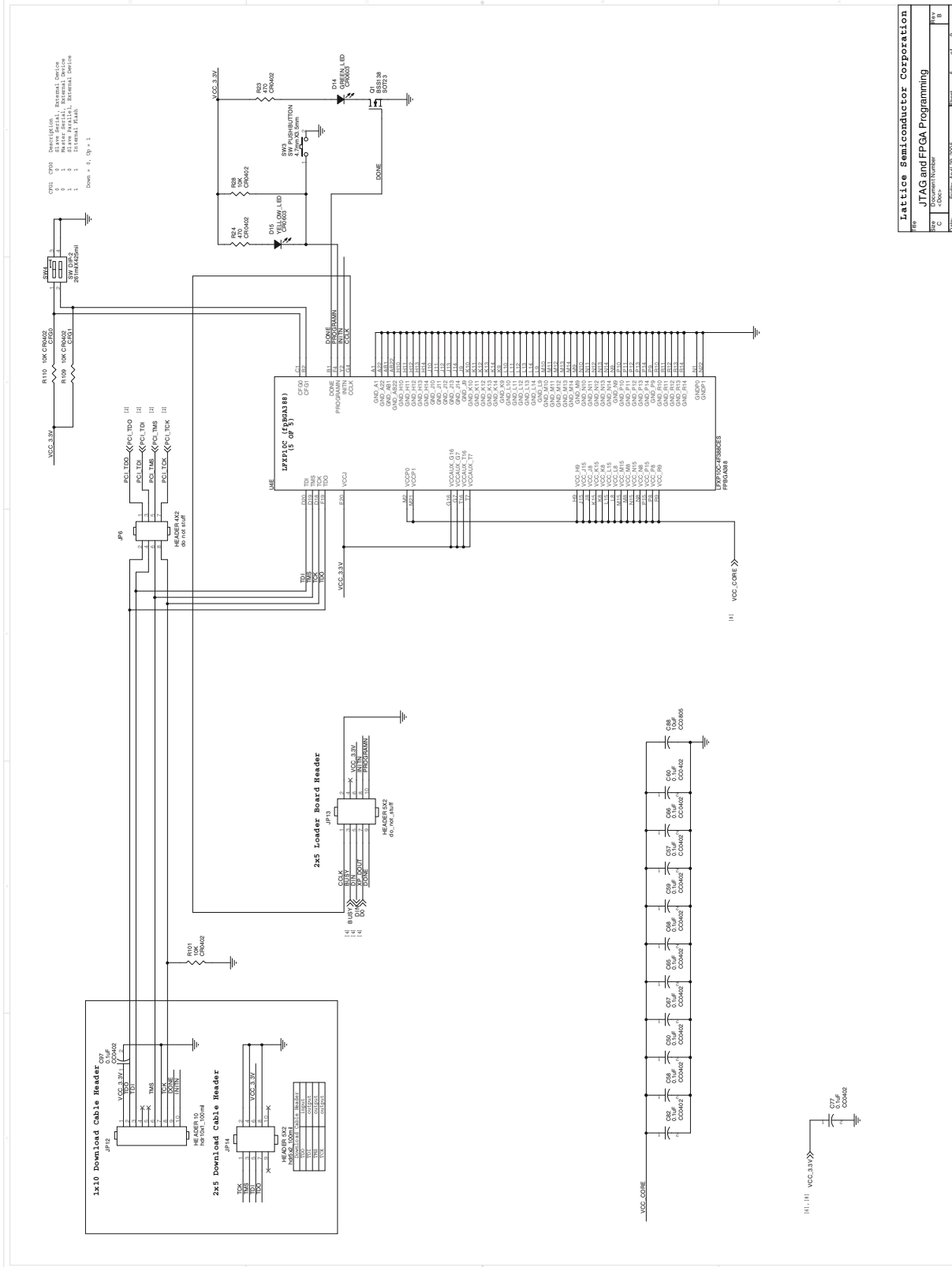

Lattice Semiconductor Corporation			
File	JTAG and FPGA Programming		
Rev	Document Number	Rev	B
C	-000-	Rev	B
Date	1999.05.12	Sheet	3 of 9

Figure 13. Ethernet PHY

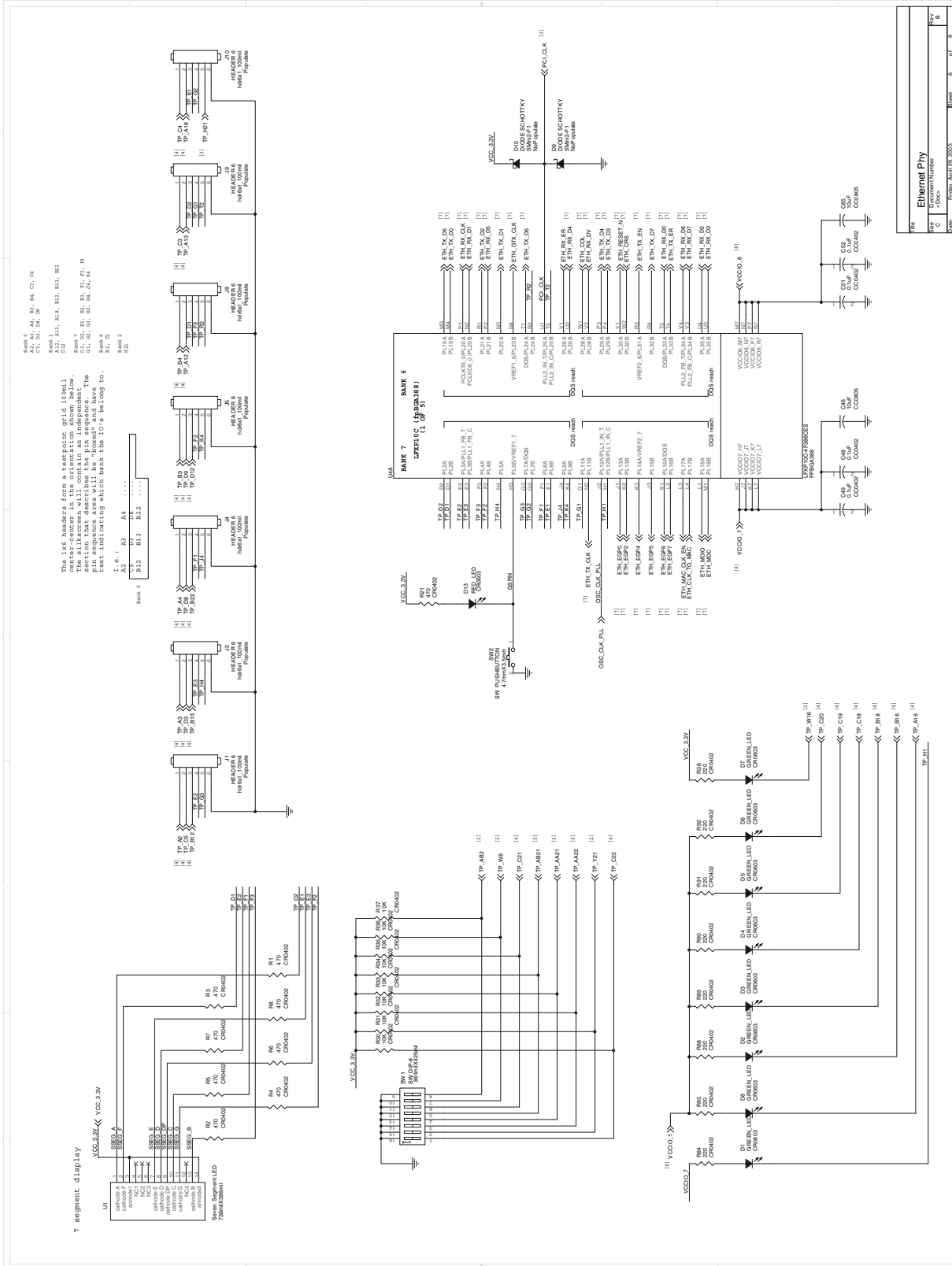
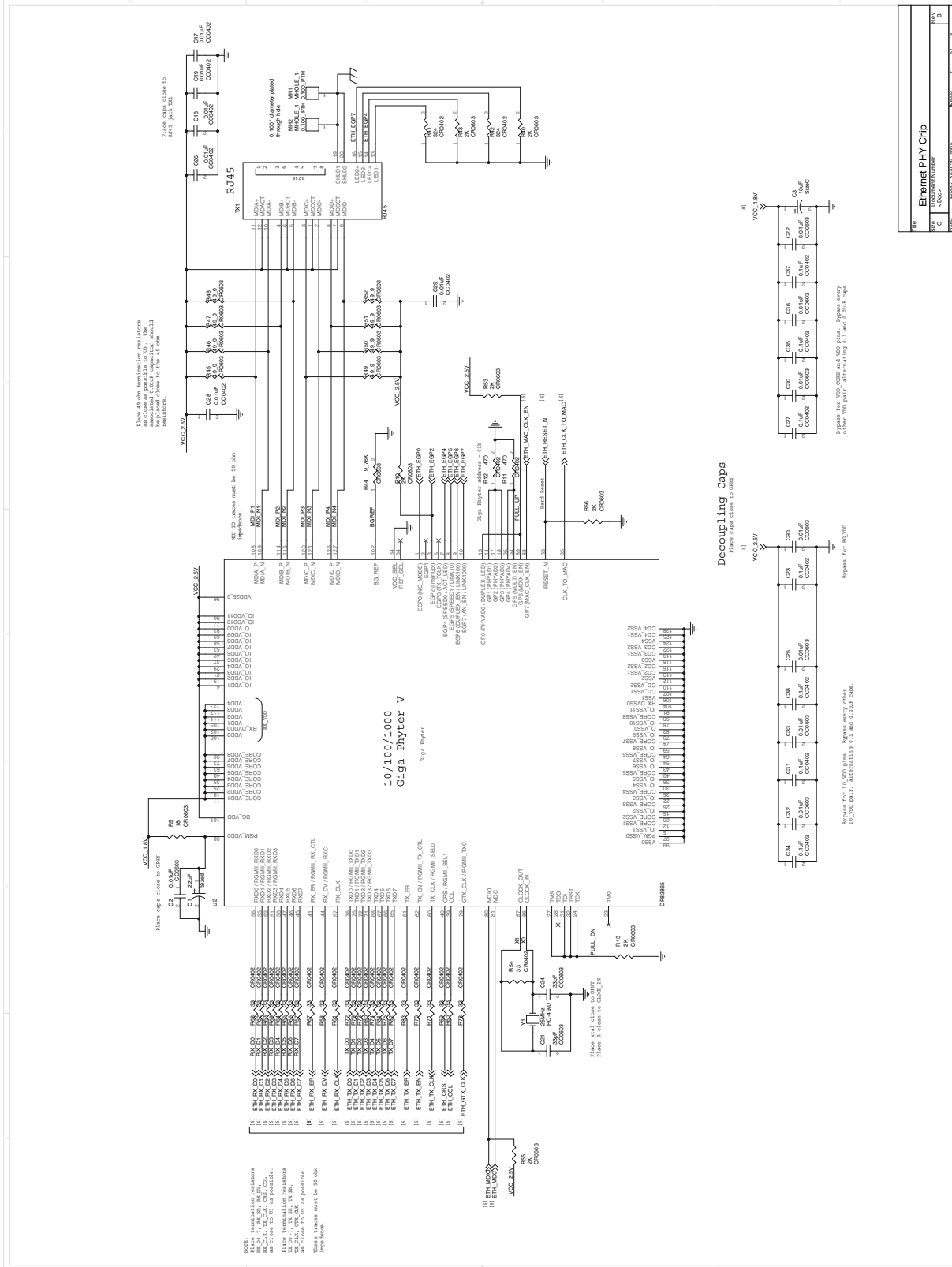
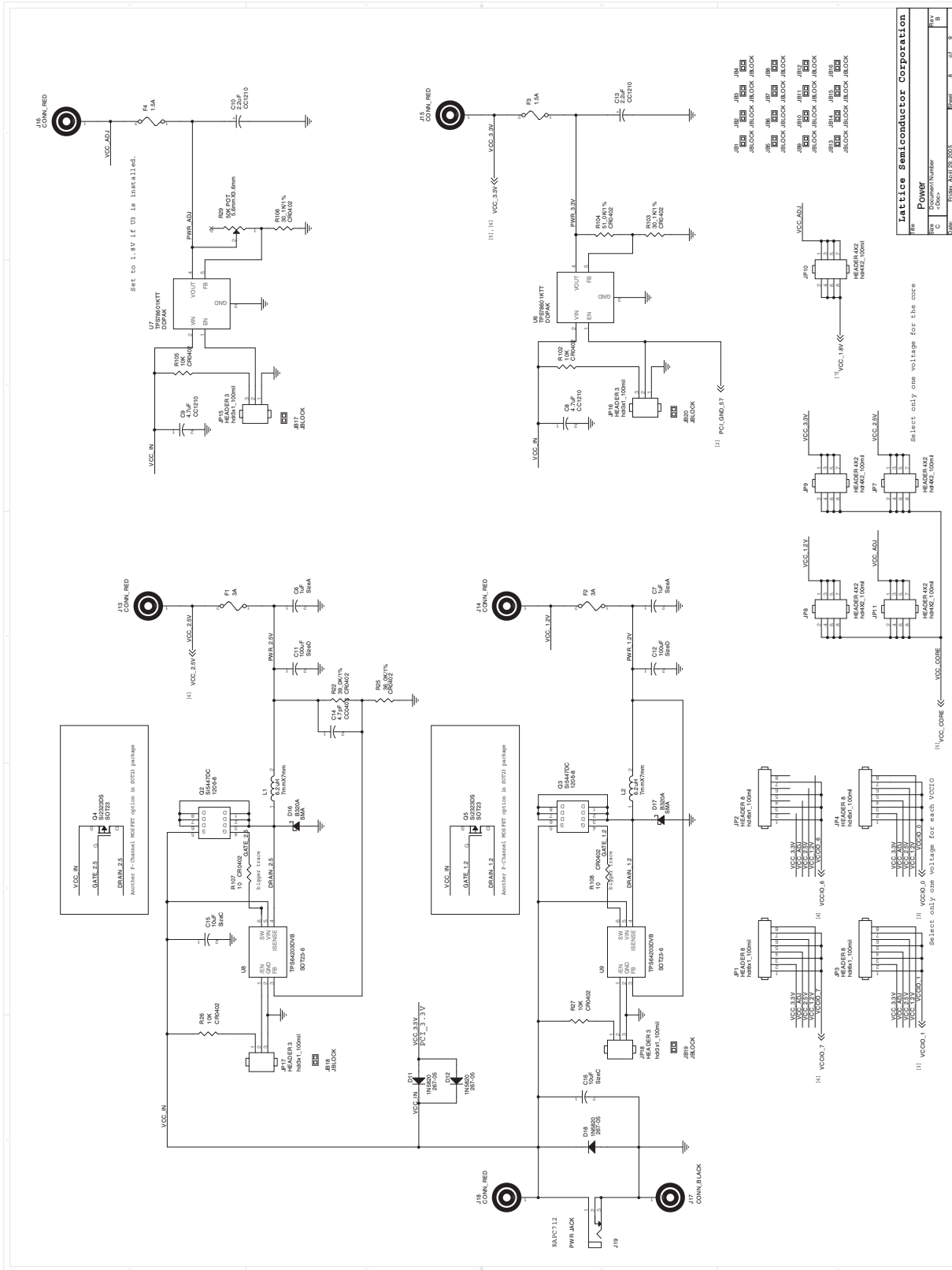

Figure 14. Ethernet PHY Chip



File	Ethernet PHY Chip		
Rev	C		
Docu	-000-		
Rev	7	01	8

Figure 15. Power



Lattice Semiconductor Corporation		
File	Power	
Rev	C	
Doc#	-000	
Rev	8	
Date	12/15/2010 10:28:00 AM	