

High temperature 16 A SCRs

Datasheet – production data

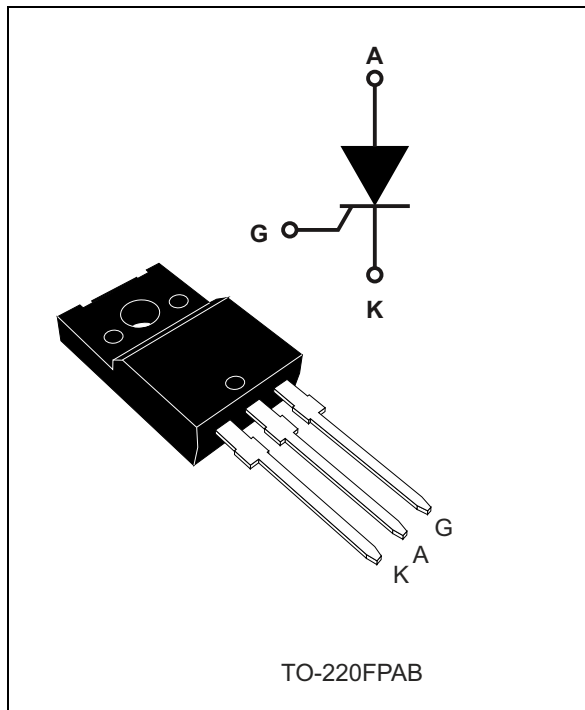

Features

- High junction temperature: $T_j = 150\text{ °C}$
- High noise immunity $dV/dt = 200\text{ V}/\mu\text{s}$ up to 150 °C
- Gate triggering current $I_{GT} = 6\text{ mA}$
- Blocking voltage $V_{DRM}/V_{RRM} = 600\text{ V}$
- High turn on current rise $di/dt: 100\text{ A}/\mu\text{s}$
- ECOPACK^{®2} compliant component
- Complies with UL standards (File ref: E81734)
- Insulated package TO-220FPAB:
 - Insulated voltage: 2000 VRMS

Applications

- Voltage regulator circuits for motorbikes
- Inrush current limiting circuits
- Motor control circuits and starters
- Light dimmers
- Solid state relays

Description

Thanks to a junction temperature up to 150 °C and an insulated TO-220FPAB package, the TN1605H-6FP offers high thermal performance up to 16 A rms .

The trade-off between the device's noise immunity ($dV/dt = 200\text{ V}/\mu\text{s}$), its gate triggering current ($I_{GT} = 6\text{ mA}$) and its turn-on current rise ($di/dt = 100\text{ A}/\mu\text{s}$) allows the design of robust and compact control circuits for voltage regulators in motorbikes and industrial drives, overvoltage crowbar protection, motor control circuits in power tools and kitchen appliances, and inrush current limiting circuits.

The insulated fullpack package allows a back-to-back configuration.

Table 1. Device summary

Order code	Package	V_{DRM}/V_{RRM}	I_{GT}
TN1605H-6FP	TO-220FPAB	600 V	6 mA

1 Characteristics

Table 2. Absolute ratings

Symbol	Parameter		Value	Unit	
$I_{T(RMS)}$	On-state rms current (180° conduction angle)		$T_c = 83\text{ °C}$	16	A
$I_{T(AV)}$	Average on-state current (180° conduction angle)		$T_c = 83\text{ °C}$	10	A
			$T_c = 102\text{ °C}$	8	
			$T_c = 117\text{ °C}$	6	
I_{TSM}	Non repetitive surge peak on-state current (T_j initial = 25 °C)		$t = 8.3\text{ms}$	153	A
			$t = 10\text{ ms}$	140	
I^2t	I^2t value for fusing (T_j initial = 25 °C)		$t_p = 10\text{ ms}$	98	A ² s
di/dt	Critical rate of rise of on-state current $I_G = 2 \times I_{GT}$, $t_r \leq 100\text{ ns}$, $T_j = 25\text{ °C}$		$f = 60\text{ Hz}$	100	A/ μs
V_{DRM} , V_{RRM}	Repetitive peak off-state voltage			600	V
I_{GM}	Peak gate current	$t_p = 20\text{ }\mu\text{s}$	$T_j = 150\text{ °C}$	4	A
$P_{G(AV)}$	Average gate power dissipation		$T_j = 150\text{ °C}$	1	W
T_{stg} T_j	Storage junction temperature range			- 40 to + 150	°C
	Operating junction temperature range			- 40 to + 150	
T_L	Maximum lead temperature for soldering during 10 s			260	°C
V_{ins}	Insulation rms voltage, 1 minute		TO-220FPAB	2000	V

Table 3. Electrical characteristics ($T_j = 25\text{ °C}$, unless otherwise specified)

Symbol	Test conditions			Value	Unit
I_{GT}	$V_D = 12\text{ V}$, $R_L = 33\text{ }\Omega$		Min.	3.5	mA
			Typ.	4.5	
			Max.	6	
V_{GT}	$V_D = 12\text{ V}$, $R_L = 33\text{ }\Omega$		Max.	1.3	V
V_{GD}	$V_D = V_{DRM}$, $R_L = 3.3\text{ k}\Omega$	$T_j = 150\text{ °C}$	Min.	0.2	V
I_H	$I_T = 500\text{ mA}$, gate open		Max.	20	mA
I_L	$I_G = 1.2 \times I_{GT}$		Max.	40	mA
dV/dt	$V_D = 402\text{ V}$, gate open	$T_j = 150\text{ °C}$	Min.	200	V/ μs
t_{gt}	$I_T = 32\text{ A}$, $V_D = 600\text{ V}$, $I_G = 100\text{ mA}$, (di_G/dt) _{max} = 0.2 A/ μs		Typ	1.9	μs
t_q	$V_D = 402\text{ V}$, $V_R = 25\text{ V}$, $I_T = 16\text{ A}$, (di_G/dt) _{max} = 30A/ μs , $dV_D/dt = 40\text{ V}/\mu\text{s}$	$T_j = 150\text{ °C}$	Typ	70	μs

Table 4. Static characteristics

Symbol	Test conditions		Value	Unit	
V_{TM}	$I_{TM} = 32 \text{ A}$, $t_p = 380 \mu\text{s}$	$T_j = 25 \text{ }^\circ\text{C}$	Max.	1.6	V
V_{t0}	Threshold voltage	$T_j = 150 \text{ }^\circ\text{C}$	Max.	0.82	V
R_d	Dynamic resistance	$T_j = 150 \text{ }^\circ\text{C}$	Max.	25	m Ω
I_{DRM} , I_{RRM}	$V_D = V_{DRM}$, $V_R = V_{RRM}$	$T_j = 25 \text{ }^\circ\text{C}$	Max.	5	μA
		$T_j = 150 \text{ }^\circ\text{C}$		1.5	mA

Table 5. Thermal resistance

Symbol	Parameter	Value	Unit
$R_{th(j-c)}$	Junction to case (AC)	4.5	$^\circ\text{C/W}$
$R_{th(j-a)}$	Junction to ambient (DC)	60	$^\circ\text{C/W}$

Figure 1. Maximum power dissipation versus average on-state current

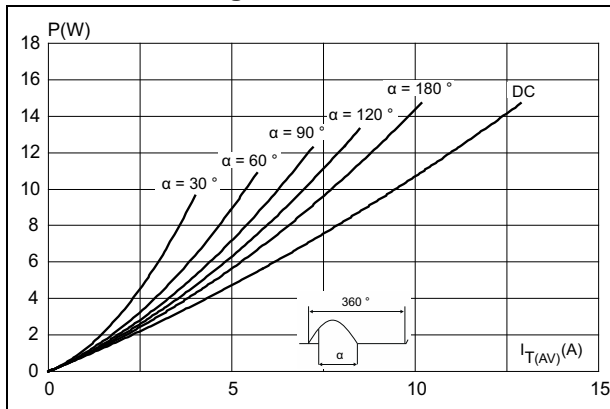

Figure 2. Average and DC on-state current versus case temperature

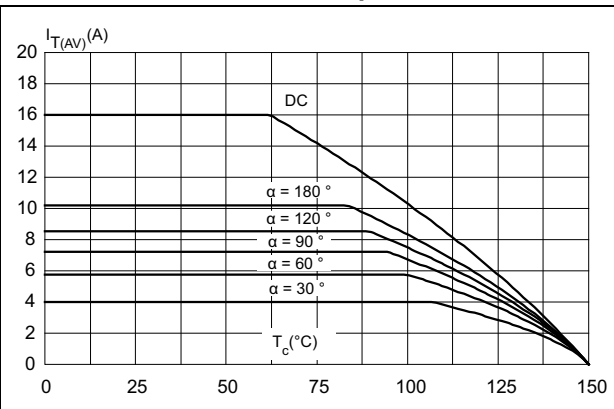

Figure 3. Average and DC on-state current versus ambient temperature

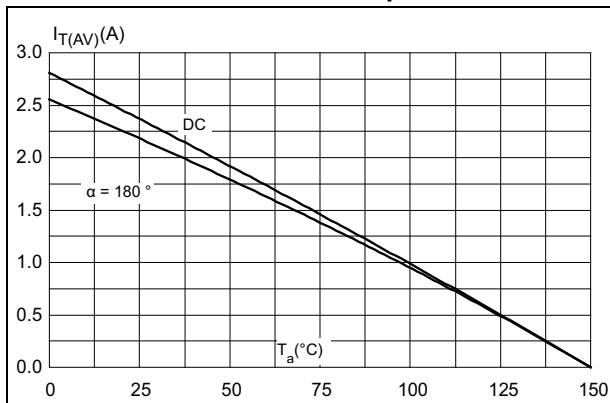

Figure 4. Relative variation of thermal impedance versus pulse duration

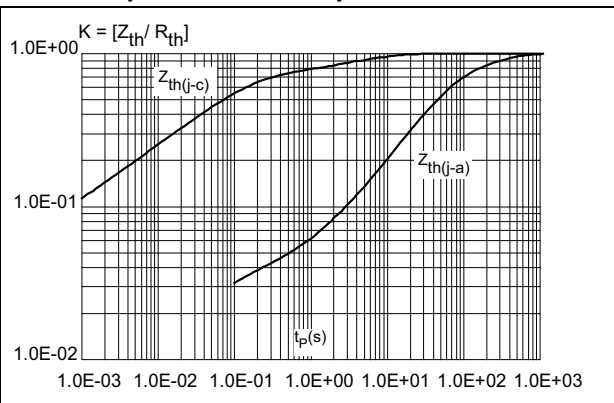

Figure 5. Relative variation of gate triggering current and gate voltage versus junction temperature (typical values)

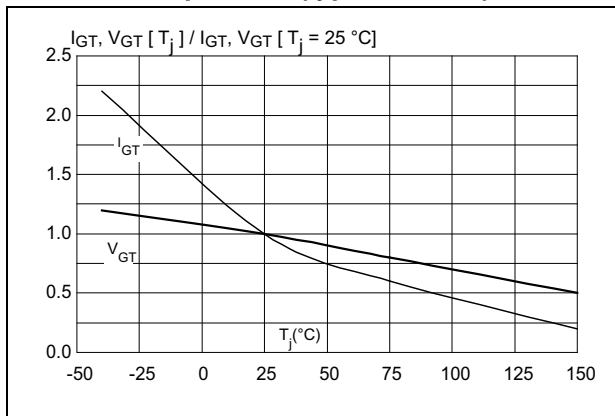

Figure 6. Relative variation of holding current and latching current versus junction temperature (typical values)

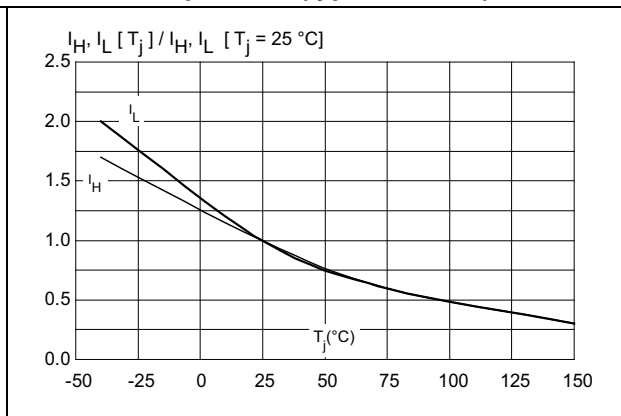

Figure 7. Relative variation of static dV/dt immunity versus junction temperature (typical values)

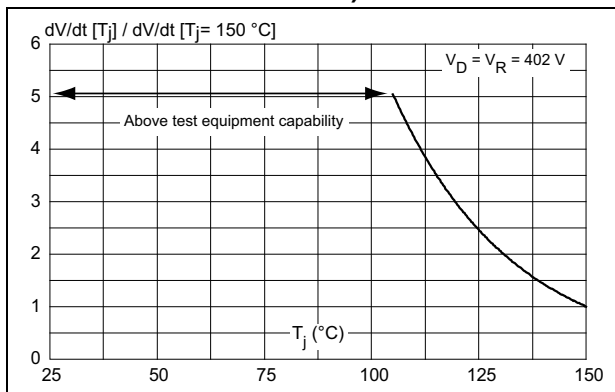

Figure 8. Surge peak on-state current versus number of cycles

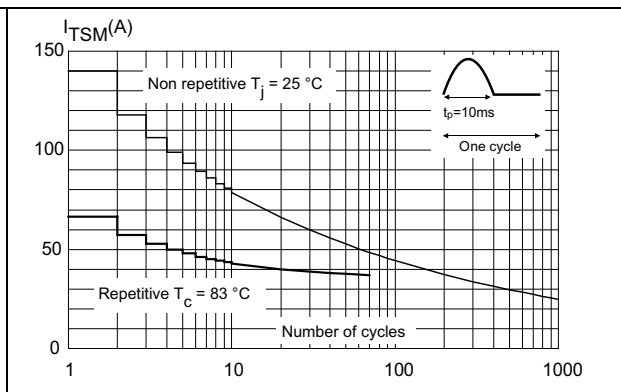

Figure 9. Non-repetitive surge peak on-state current for a sinusoidal pulse ($t_p < 10\text{ ms}$)

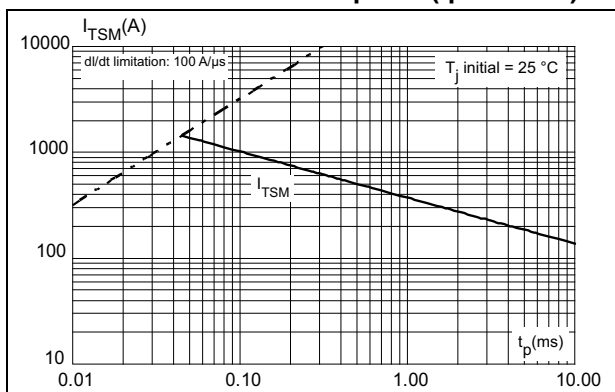

Figure 10. On-state characteristics (maximum values)

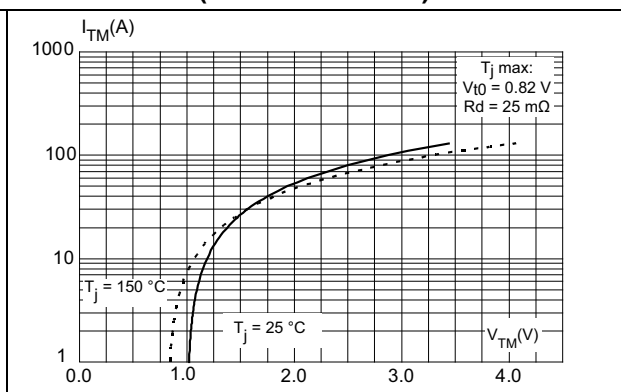
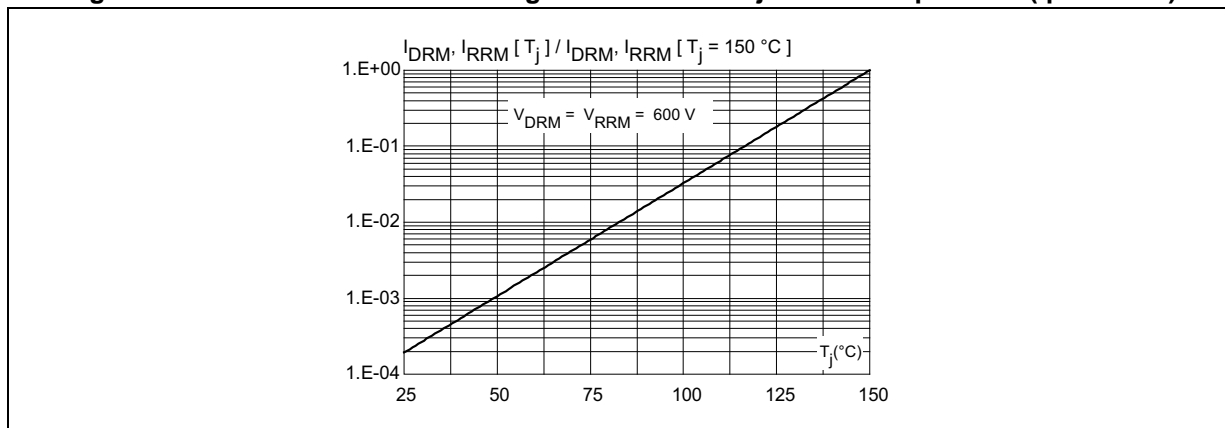

Figure 11. Relative variation of leakage current versus junction temperature (tp < 10 ms)



2 Package information

- Epoxy meets UL94, V0
- Lead-free package
- Halogen free molding compound
- Recommended torque: 0.4 to 0.6 N·m

In order to meet environmental requirements, ST offers these devices in different grades of ECOPACK[®] packages, depending on their level of environmental compliance. ECOPACK[®] specifications, grade definitions and product status are available at: www.st.com. ECOPACK[®] is an ST trademark.

Figure 12. TO-220FPAB dimension definitions

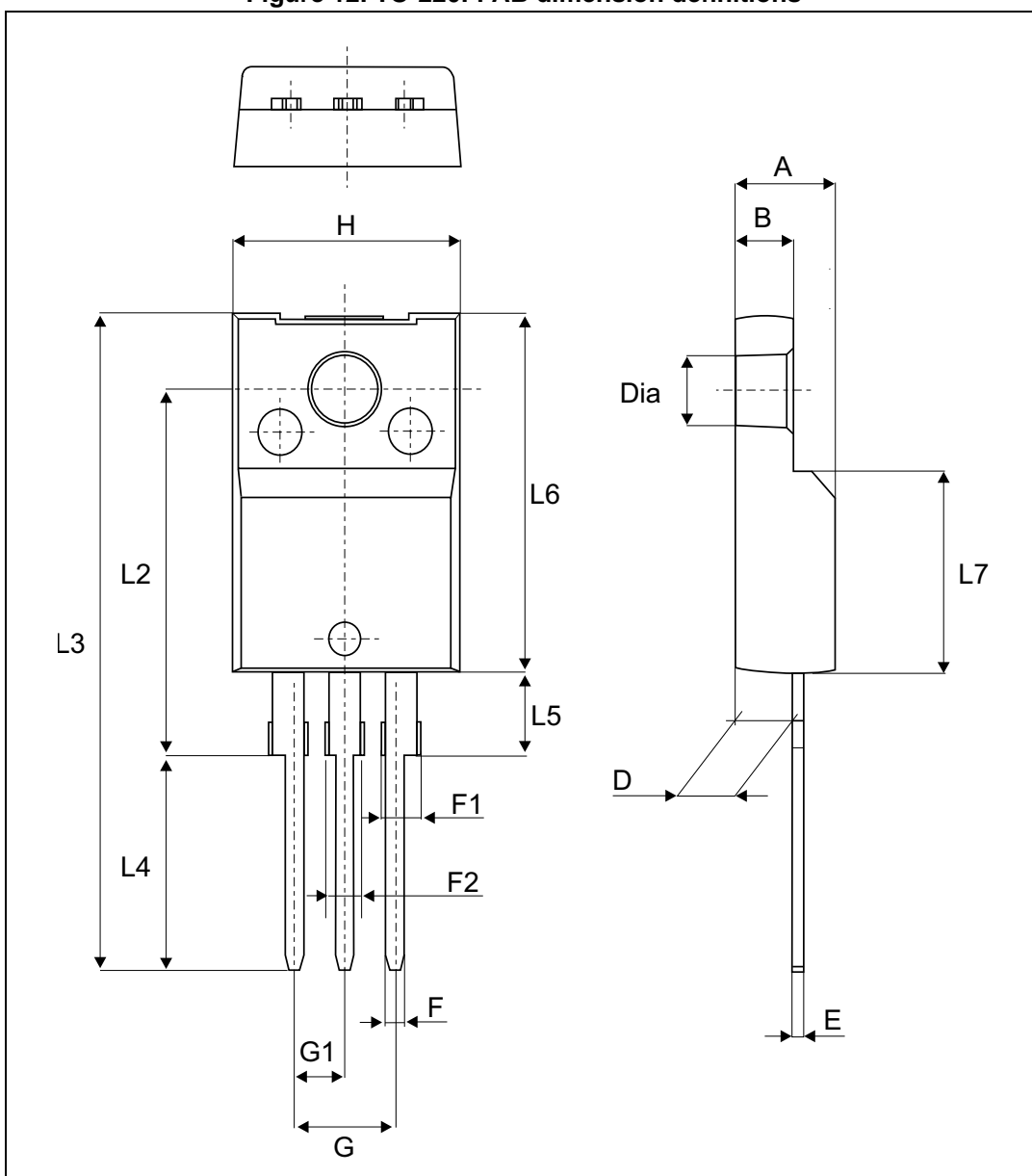

Table 6. TO-220FPAB dimensions

Ref.	Dimensions			
	Millimeters		Inches	
	Min.	Max.	Min.	Max.
A	4.4	4.6	0.173	0.181
B	2.5	2.7	0.098	0.106
D	2.5	2.75	0.098	0.108
E	0.45	0.70	0.018	0.027
F	0.75	1	0.030	0.039
F1	1.15	1.70	0.045	0.067
F2	1.15	1.70	0.045	0.067
G	4.95	5.20	0.195	0.205
G1	2.4	2.7	0.094	0.106
H	10	10.4	0.393	0.409
L2	16 Typ.		0.63 Typ.	
L3	28.6	30.6	1.126	1.205
L4	9.8	10.6	0.386	0.417
L5	2.9	3.6	0.114	0.142
L6	15.9	16.4	0.626	0.646
L7	9.00	9.30	0.354	0.366
Dia.	3.00	3.20	0.118	0.126

3 Ordering information

Figure 13. Ordering information scheme

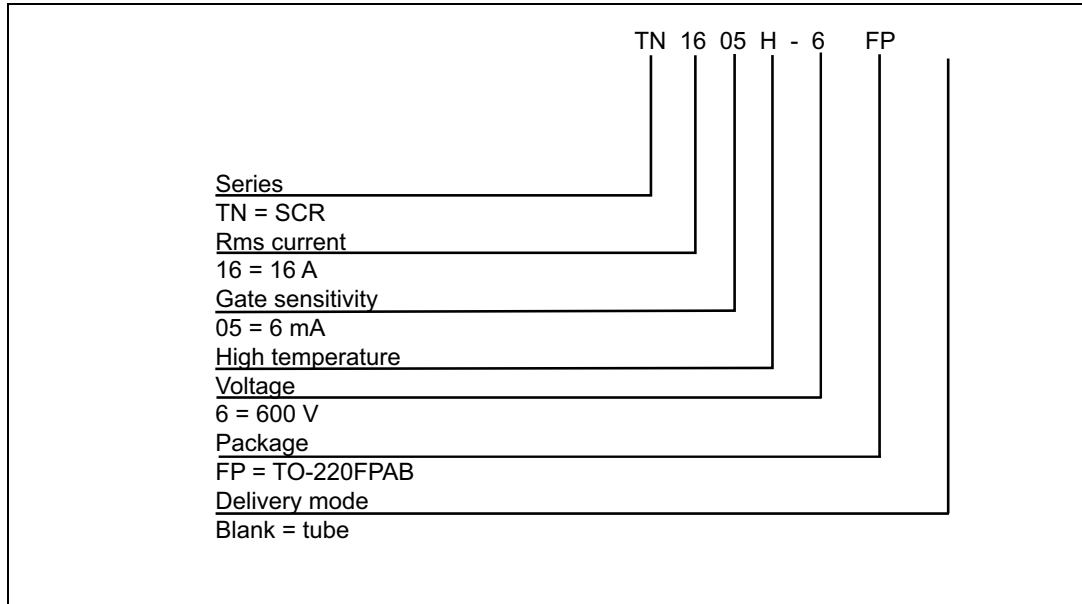

Table 7. Ordering information

Order code	Marking	Package	Weight	Base qty	Delivery mode
TN1605H-6FP	TN1605H6	TO-220FPAB	2.0 g	50	Tube

4 Revision history

Table 8. Document revision history

Date	Revision	Changes
24-Feb-2015	1	Initial release.

IMPORTANT NOTICE – PLEASE READ CAREFULLY

STMicroelectronics NV and its subsidiaries ("ST") reserve the right to make changes, corrections, enhancements, modifications, and improvements to ST products and/or to this document at any time without notice. Purchasers should obtain the latest relevant information on ST products before placing orders. ST products are sold pursuant to ST's terms and conditions of sale in place at the time of order acknowledgement.

Purchasers are solely responsible for the choice, selection, and use of ST products and ST assumes no liability for application assistance or the design of Purchasers' products.

No license, express or implied, to any intellectual property right is granted by ST herein.

Resale of ST products with provisions different from the information set forth herein shall void any warranty granted by ST for such product.

ST and the ST logo are trademarks of ST. All other product or service names are the property of their respective owners.

Information in this document supersedes and replaces information previously supplied in any prior versions of this document.

© 2015 STMicroelectronics – All rights reserved