

UNLESS OTHERWISE NOTED
 DIMENSIONS ARE IN INCHES TOLERANCES ARE:
 ONE PLACE DECIMALS ±.1[2.5] THREE PLACE DECIMALS ±.005[.13]
 TWO PLACE DECIMALS ±.01[.3] FOUR PLACE DECIMALS ±.0020[.051]
 ANGLES ± 2°

TITLE:
**2mm x 2mm
 TERMINAL STRIP ASSEMBLY**

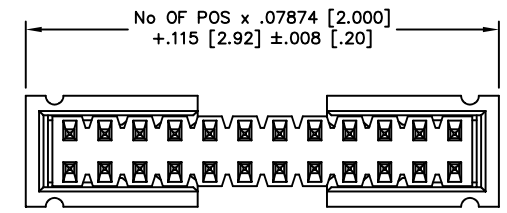

FIG. 2
-ES

STYLE	"A"	"B"	SHROUD
-01, -06, -21	.202 [5.13]	.210 [5.33]	TMMH-ES-01
-04, -05, -22	.149 [3.78]	.157 [3.99]	TMMH-ES-04

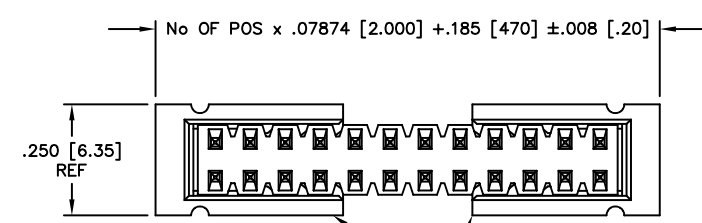
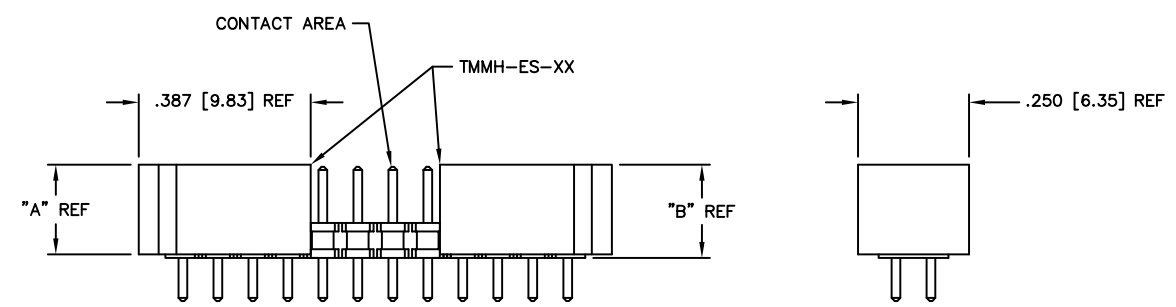

FIG. 4
-EC

STYLE	"A"	"B"	SHROUD
-01, -06, -21	.202 [5.13]	.210 [5.33]	TMMH-EC-01
-04, -05, -22	.149 [3.78]	.157 [3.99]	TMMH-EC-04

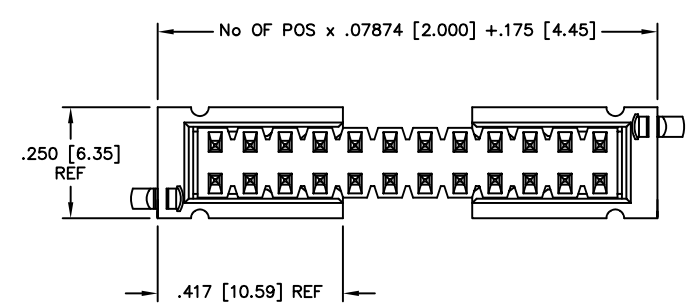
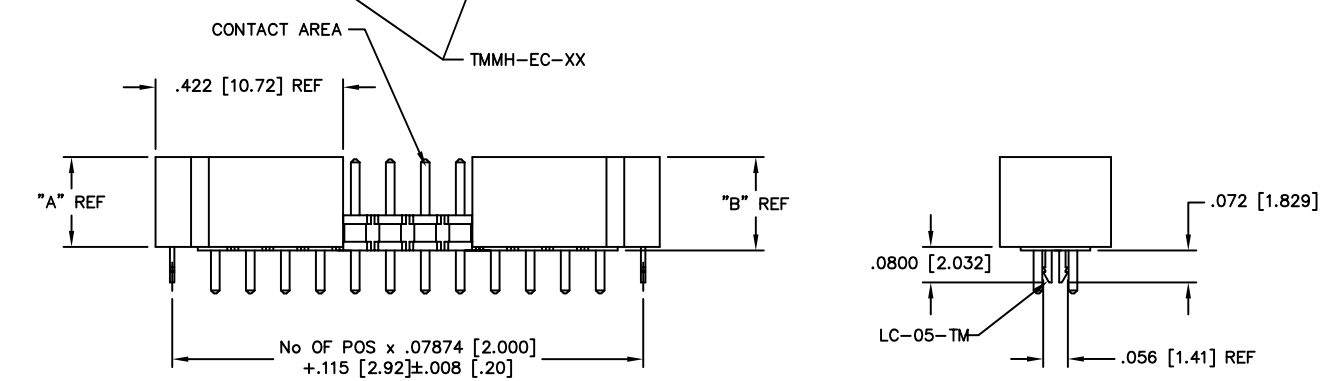

FIG. 3
-EL

STYLE	"A"	"B"	SHROUD
-01, -06, -21	.202 [5.13]	.210 [5.33]	TMMH-EL-01
-04, -05, -22	.149 [3.78]	.157 [3.99]	TMMH-EL-04

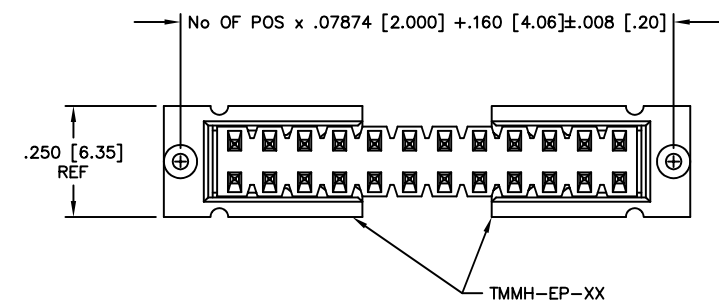
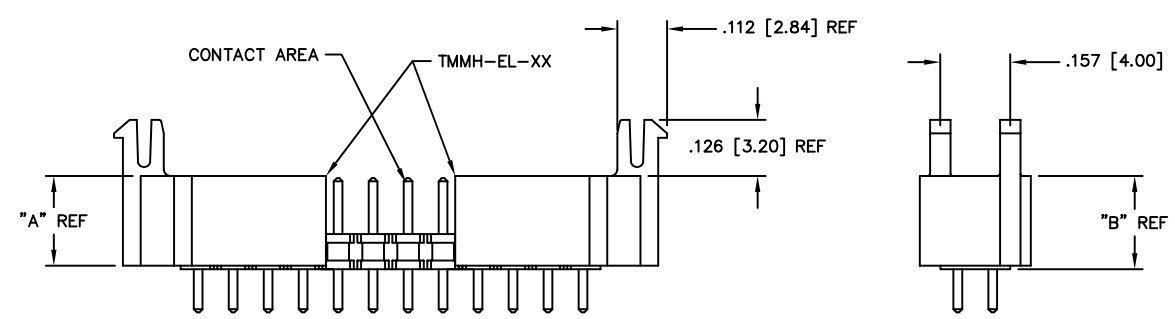
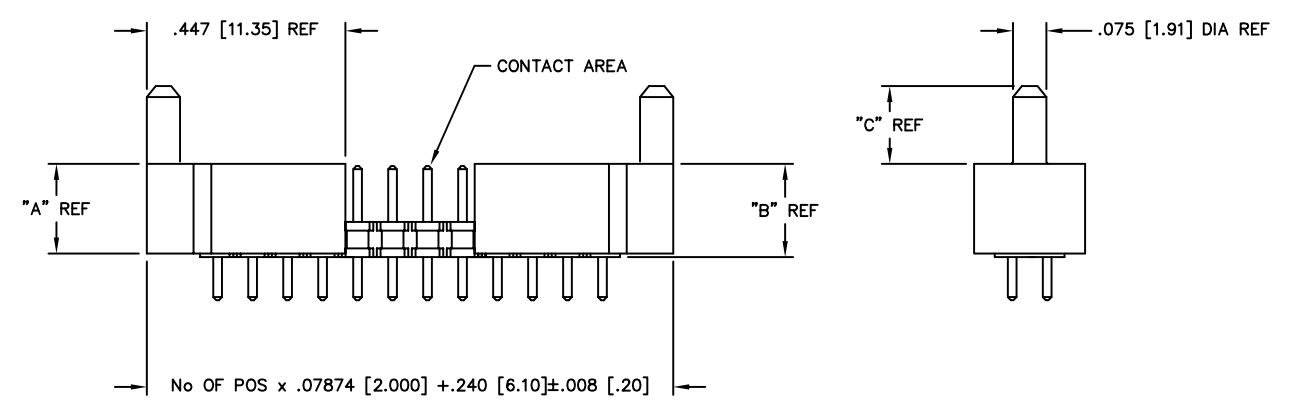

FIG. 5
-EP

STYLE	"A"	"B"	"C"	SHROUD
-01, -06, -21	.202 [5.13]	.210 [5.33]	.175 [4.45]	TMMH-EP-01
-04, -05, -22	.149 [3.78]	.157 [3.99]	.119 [3.02]	TMMH-EP-04



ALL FIGURES
 DIFFERENT AS SHOWN,
 OTHERWISE SAME AS FIG. 1

PATENT PENDING

PROPRIETARY NOTE
 THIS DOCUMENT CONTAINS INFORMATION
 CONFIDENTIAL AND PROPRIETARY TO
 SAMTEC INC. AND SHALL NOT BE
 REPRODUCED OR TRANSFERRED TO
 OTHER DOCUMENTS OR DISCLOSED TO
 OTHERS OR USED FOR ANY PURPOSE
 OTHER THAN THAT FOR WHICH IT WAS
 OBTAINED WITHOUT THE EXPRESSED
 WRITTEN CONSENT OF SAMTEC INC.



EXISPROD\ASSEMBLY\2MM
 TMMH-TH2
 520 PARK EAST BLVD. NEW ALBANY, INDIANA 47150
 PHONE (812) 944-6733 P.O. BOX 1147
 CODE 55322

MADE BY:
 PURVIS 12-17-96

This document was created with Win2PDF available at <http://www.daneprairie.com>.
The unregistered version of Win2PDF is for evaluation or non-commercial use only.